

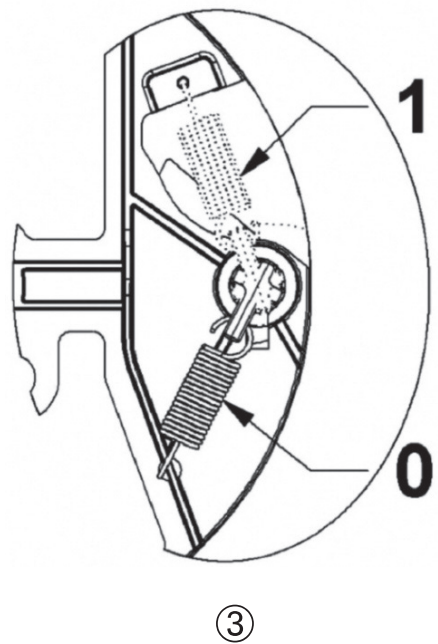

1910/8 - 1910/10

Operation manual and instructions

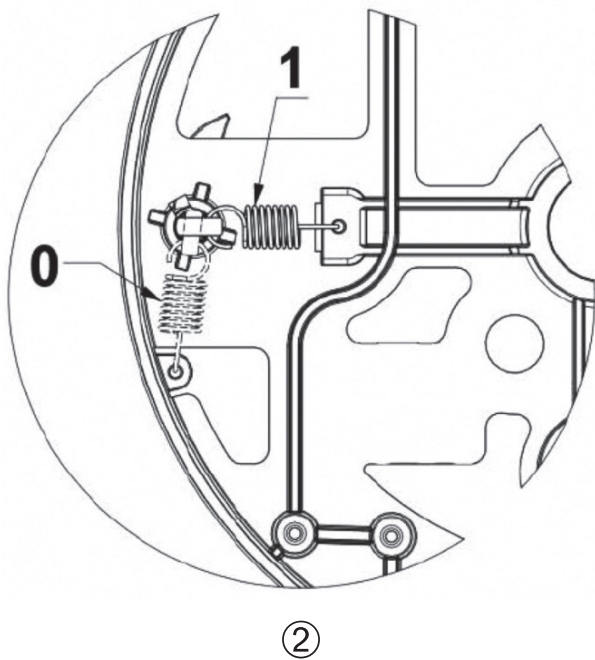
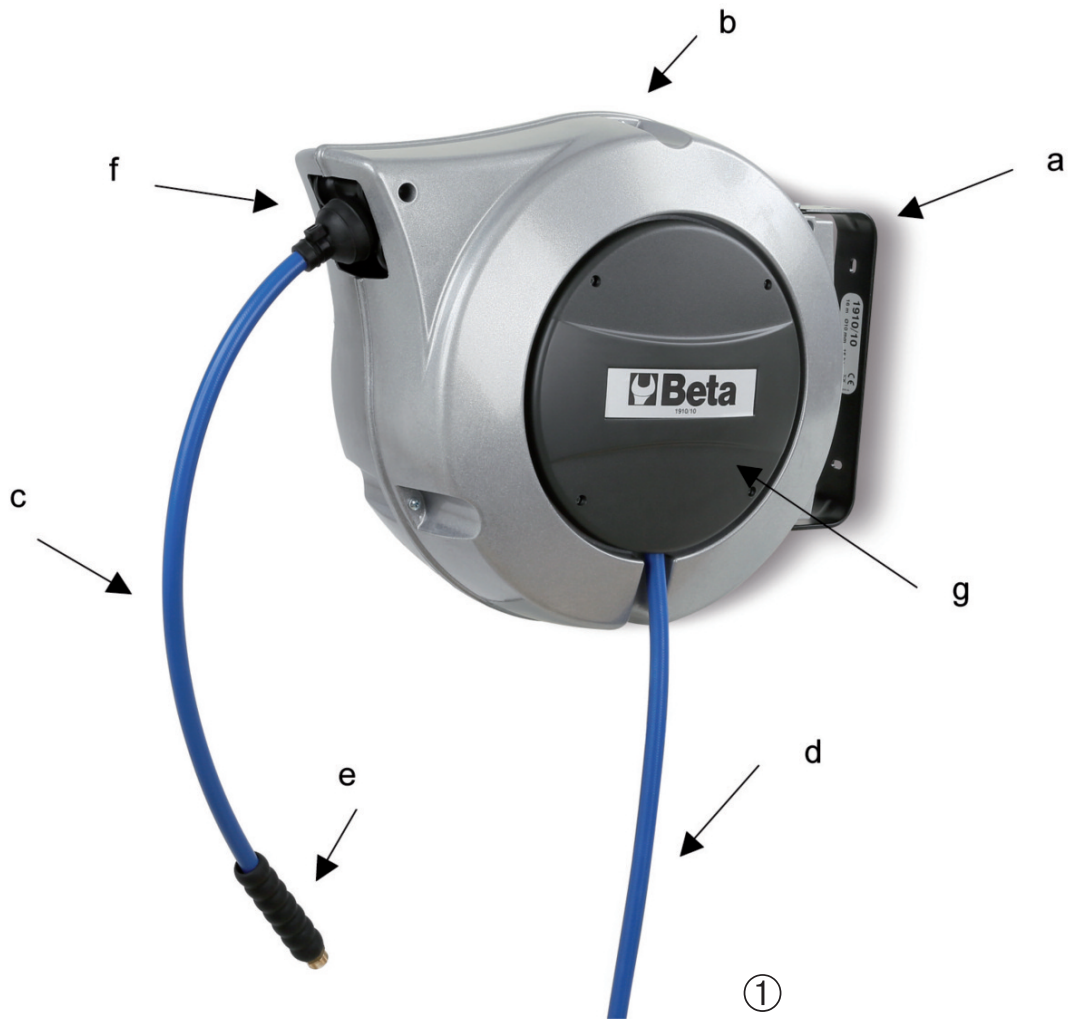

OPERATION MANUAL AND INSTRUCTIONS FOR AUTOMATIC HOSE REEL MANUFACTURED BY:

**BETA UTENSILI
S.P.A.**

Original documentation drawn up in ITALIAN.



CAUTION



IT IS IMPORTANT TO READ THIS MANUAL THOROUGHLY BEFORE USING THE AUTOMATIC HOSE REEL. FAILURE TO COMPLY WITH THE SAFETY STANDARDS AND OPERATING INSTRUCTIONS MAY RESULT IN SERIOUS INJURY.

Store the safety instructions with care and hand them over to the users.

PURPOSE OF USE

- **The automatic hose reel can be used for the following purposes:**
 - piping compressed air or cold water
 - the automatic hose reel can also be used in open places, avoiding direct exposure of the hose reel to bad weather or sunlight
- **The automatic hose reel must not be used for the following operations:**
 - no combustible "liquids and/or gases" may be used
 - no corrosive substances may be used
 - the automatic hose reel must not be used with fluids at temperatures higher than the temperatures stated in the TECHNICAL DATA table
 - the automatic hose reel must not be used in environments containing potentially explosive atmospheres
 - the hose winding device must not be forced
 - the hose must not be used for hooking or dragging material

WORK AREA SAFETY

- Beware of both surfaces that may become slippery and the danger of tripping over the air hose.
- While using the automatic hose reel for jobs performed high from the ground, take all necessary precautions, to eliminate or minimize risk to other workers, following accidental falling of any tools (for example, isolation of the work area and proper signs).
- ⚠ Do not operate the automatic hose reel in environments containing potentially explosive atmospheres, because sparks may be generated, which can ignite the dust or fumes.
- ⚠ Contact with live equipment should be avoided, because it may cause electric shocks.
- ⚠ Avoid contact between the hose and incandescent or hot parts.
- ⚠ Keep children and bystanders away from your workplace while operating the automatic hose reel. Distractions from other people can cause you to lose control over the automatic hose reel while using it.

AUTOMATIC HOSE REEL SAFETY

- Do not point the fluid in the hose to yourself or other people. Compressed air or the fluid can cause injury.
- Check the connections and the air supply lines. All units, couplers and hoses should conform to the product specifications in terms of pressure and air volume. Too high pressure impairs the function of the hose reel and may cause damage and/or injury.
- Do not bend or tighten any hoses; avoid using solvents and sharp edges. Keep the hoses away from heat, oil and rotating parts. Immediately replace any damaged hose. A defective feed pipe may cause uncontrolled movements of the compressed air pipe. Raised rust or chips may cause eye injury. Make sure that the hose clamps are always secured firmly.



PERSONNEL SAFETY

- Stay alert; watch what you are doing. Do not use the hose reel while tired or under the influence of drugs, alcohol, or medication.
- **Always use the following personal protective equipment:**
 - eye protection
 - hearing protection
 - protective gloves against physical agents
- Make sure you are in a safe position, keeping a proper balance at all times. A safe working position and a proper body posture enable better control of unexpected situations.
- Do not directly breathe in the air from the hose, as it may contain water, oil, metal particles and impurities, which may cause dangers.

AUTOMATIC HOSE REEL USE AND CARE



- Do not overload the automatic hose reel, and always check it is free from defects.
- Disconnect the air supply before making adjustments, changing accessories, or placing the pneumatic tool aside.
- Store the hose reel out of the reach of children when not in use. Do not allow persons unfamiliar with these instructions to operate the hose reel.
- Maintain the automatic hose reel with care, checking that the hose is free from defects and no parts are broken or damaged to such an extent as to affect the operation of the hose reel.
- Keep the hose reel clean, to allow for perfect winding.
- Do not modify the automatic hose reel. This can reduce the effectiveness of safety measures and increase operator risk.
- Have the pneumatic tool repaired only through a qualified repair person and only using original replacement parts.

AUTOMATIC HOSE REEL SAFETY

- If the hose should break, the fluid in it may cause uncontrolled movements, and thus injury.
 - Operators and maintenance personnel should be physically able to handle the weight and power of the hose reel.
 - Firmly fix the revolving metal bracket of the hose reel to a wall or a stable structure, making sure that it can support the load.
 - Periodically check that the bracket is intact and properly secured to the wall or the supporting structure.
 - Maintain a firm grip on the hose while winding it. It is important to be prepared for unexpected movements of the hose while winding it.
 - While winding the hose, make sure that it does not cause hazards or damage to people or things.
 - In case of air supply failure or low operating temperature, check the operating pressure before reusing the hose reel.
-  Dust and fumes hazards: if the hose reel is used in particular situations due to the presence of potentially harmful particles or fumes, protective equipment for the upper respiratory tract must be used. An appropriate environmental hygiene survey is required to determine the type and degree of protection of the personal protective equipment to use.
-  Using the hose reel with certain accessories may generate noise, which may prove harmful to the exposed personnel. A proper phonometric survey is required to determine the personal hearing protective equipment (hearing protection) to use.
- Pull the hose steadily, using the right amount of force, avoiding overloading and tugging the hose.

PERSONAL PROTECTIVE EQUIPMENT TO WEAR WHILE OPERATING AUTOMATIC HOSE REEL

 Failure to observe the following warnings may result in physical injury and/or disease.

	ALWAYS WEAR HEARING PROTECTION WHILE OPERATING HOSE REEL
	ALWAYS WEAR EYE PROTECTION WHILE OPERATING HOSE REEL OR PERFORMING MAINTENANCE JOBS
	ALWAYS WEAR PROTECTIVE GLOVES AGAINST PHYSICAL AGENTS WHILE OPERATING HOSE REEL

 Additional personal protective equipment to wear according to the values found in the environmental hygiene/risk analysis survey if the values exceed the limits under current regulations.

	WEAR PROTECTIVE MASK AGAINST PHYSICAL AGENTS
---	--

PRODUCT SPECIFICATIONS

	1910/8	1910/10
AIR INLET	1/4" GAS	3/8" GAS
MAXIMUM PRESSURE	15 Bar	15 Bar
INTERNAL HOSE SIZE (Ø)	8 mm	10 mm
FLUID OPERATING PRESSURE	-5°C +40°C	-5°C +40°C
WEIGHT	6 Kg	9 Kg
HOSE LENGTH	9 m	15 m

KEY TO SYMBOLS

- a: metal fixing bracket, revolving
- b: die-cast aluminium frame
- c: polyurethane hose
- d: air/water polyurethane hose
- e: air/water outlet 1/4" - 3/8 " GAS
- f: hose winding limiting device
- g: side cover

USE

Air supply connection

For correct use of the automatic hose reel, always keep to a maximum pressure of 15 bars. Feed the hose reel with clean, condensate-free air. Excessively high pressure or humidity in supply air may damage the tool or cause injury.

Hose reel adjustment

The automatic hose reel is fitted with a spring winding system with automatic locking at the required length. Adjust the hose winding limiting device as needed.

Hose pulling

Pull the hose as follows:

- pull the hose by hand until the required length is achieved;
- the hose is locked by means of the spring ratchet, which is activated in certain pulling points of the hose, which can be heard through the mechanical noise of the engaged ratchet;
- the automatic safety catch locks the hose, thereby preventing it from winding completely and rapidly.

Hose winding

Wind the hose as follows:

- pull the hose by hand to automatically release the ratchet;
- ease the hose while winding it, being careful to avoid interference with persons or things;
- the hose is fitted with a hose winding limiting device which stops it, thereby preventing it from winding completely.

Safety catch disconnection

The safety catch of the hose reel can be can cut out as follows:

- open the side cover on the hose reel by unscrewing its fixing screws;
- release the ratchet spring from fixing point 1 and hook it to fixing point 0 (for item 1910/8, picture 2);
- release the ratchet spring from fixing point 1 and hook it to fixing point 0 (for item 1910/10, picture 3);
- put back the cover, replacing and tightening the screws correctly. During this operation, the hose must be completely rewound.

Always disconnect the air supply before carrying out any jobs on the hose reel.

Lubrication

The hose reel should be connected to a compressed air supply system complete with filtering system for solid particles, if need be.

MAINTENANCE

Maintenance and repair jobs must be carried out by trained personnel. For such jobs, you can contact Beta Utensili S.P.A.'s repair centre.

DISPOSAL

The hose reel must be disposed of in accordance with the law provisions in force in the country where it is used.

WARRANTY

This equipment is manufactured and tested in accordance with current EU regulations. It is covered by a 12-month warranty for professional use or a 24-month warranty for nonprofessional use.

We will repair any breakdowns caused by material or manufacturing defects, by fixing the defective pieces or replacing them at our discretion.

Should assistance be required once or several times during the warranty period, the expiry date of this warranty will remain unchanged.

This warranty will not cover defects due to wear, misuse or breakdowns caused by blows and/or falls.

In addition, this warranty will no longer be valid if any changes are made, or if the pneumatic tool is forced or sent to the customer service in pieces.

This warranty explicitly excludes any damage caused to people and/or things, whether direct or consequential.

DECLARATION OF CONFORMITY

We hereby declare, assuming full responsibility, that the described product complies with all the relevant provisions of Machine Directive 2006/42/EC and amendments thereto, as well as with the following standard:

- EN ISO 12100

Name and title of person in charge

ROBERTO CICERI
(President)

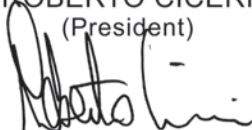

BETA UTENSILI S.P.A.

Date 01/01/2015