

# Accessories & Spare Parts

Clamping and cutting technology, July 1 2019

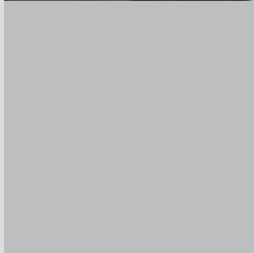

Simply better.



# BESSEY® 2019 Accessories & spare parts

## 3 Malleable cast iron screw clamps



TG  
TGJ  
TGK  
CDS

## 4 All-steel screw clamps



660  
1200  
J18-8  
SGL, SQ, STB

## 4 OMEGA screw clamp



RSC

## 5 Lever clamps



LC  
GSH

## 6 High performance clamps



1800, 2400, 4800, 7200,  
8500  
SQ, SG30VAD

## 7 Variable screw clamps



SLV  
GSV

## 8 Claw clamp



CL24

## 8 K Body REVO



KRE  
KREV

## 9 One handed clamp



PG

## 9 Edge clamps



EKT  
KF  
KFP

## 9 Strap clamps



VAS

## 10 Grip pliers



SG4  
SG8  
SG24

## 10 Seaming tools



PS

## 10 Self-adjusting toggle clamps



STC-VH  
STC-HH  
STC-HV  
STC-HA  
STC-IHH  
STC-IHA

## 11 Welding table clamps



TWV  
TW  
TWM  
TWGR  
TWWAD  
TWA

## 12 Machine table clamps



BAS  
BSN  
1200HD  
2400HD

## 12 Cutting tools



DBK  
D24

Sliding arm cpl. with 2-component plastic handle		Sliding arm cpl. with break/ wooden handle		Wood handle, incl. high-quality steel pressure plate with protection cap			2-component plastic handle, incl. high-quality steel pressure plate with protection cap			Pressure plate changeable from size 16	Protection cap for moveable jaw & for fixed jaw	
										4 pcs./bag	10 pairs./bag	
Throat depth mm	For rail mm	Throat depth mm	For rail mm	Length x Ø mm	Head Ø mm	Acme thread mm	Length x Ø mm	Head Ø mm	Acme thread mm	Ø mm	For Ø mm	For width mm

## Malleable cast bar clamps for TG series

TGJ							110 x 30	10	14 x 4	25.5	25.5	23	
Model no.							3101179			3101180	3101392		
TG4.0XX			100	27 x 7	112 x 30	12	16 x 4	110 x 30	12	16 x 4	32	32	28
Model no.			3101413		3101386		3101182		3101183	3101394			
TG4.5XX	120	29 x 9	120	29 x 9	125 x 32	12	16 x 4	130 x 34	12	16 x 4	32	32	30
Model no.	3101832		3101414		3101389		3101186		3101183	3101395			
TG5.5XX	140	32 x 10	140	32 x 10	140 x 35	13	18 x 5	130 x 34	13	18 x 5	38.5	38.5	32
Model no.	3101833		3101415		3101390		3101187		3101188	3101396			
TG7.0XX	175	32 x 10	175	32 x 10	140 x 35	13	18 x 5	130 x 34	13	18 x 5	38.5	38.5	32
Model no.	3101834		3101416		3101390		3101187		3101188	3101396			



## Heavy Duty malleable cast bar clamps for TGK series

TGK			120	35 x 11	140 x 35	13	18 x 5	130 x 34	13	18 x 5	38.5	25.5	23
Model no.			3101417		3101390		3101187		3101188	3101393			
TGK-K			120	35 x 11							38.5	25.5	23
Model no.			3101418								3101188	3101393	

## Deep throat CDS clamps

							Tommy bar			BESSEY® Grip	
CDS24-10			250	40 x 11	140 x 35	13	18 x 5			38.5	
Model no.			3101420		3101390		3101797		3101188	3101194	
CDS24-12			300	45 x 12	140 x 35	13	18 x 5			38.5	
Model no.			3101421		3101390		3101797		3101188	3101194	
CDS24-20					140 x 35	13	18 x 5			38.5	
Model no.					3101390		3101797		3101188	3101194	

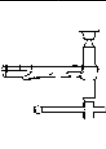
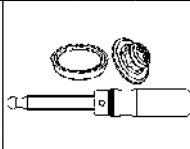
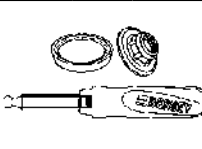
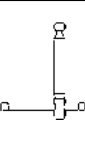
# BESSEY® 2019 Accessories & spare parts

Sliding arm cpl. with wooden handle		Sliding arm cpl. with tommy bar		Wood handle, incl. high-quality steel pressure plate with protection cap			2-component plastic handle, incl. high-quality steel pressure plate with protection cap			Tommy bar	Pressure plate changeable from size 16
											 4 pcs. in bag
Throat depth mm	For rail mm	Throat depth mm	For rail mm	Length x Ø mm	Head Ø mm	Acme thread mm	Length x Ø mm	Head Ø mm	Acme thread mm	Acme thread mm	Ø mm

## All-steel bar clamps (version 01.07.09) – New Profile

660	100	22 x 8.5	100	22 x 8.5	112 x 30	12	16 x 4	110 x 30	12	16 x 4	16 x 4	32
Model no.	3101516		3101441		3101386			3101182			3101796	3101183
1200-S8 1200-S12	140	28 x 11	140	28 x 11	140 x 35	13	18 x 5	130 x 34	13	18 x 5	18 x 5	38.5
Model no.	3101518		3101447		3101390			3101187			3101797	3101188
1200-S18 1200-S24	120	28 x 11	120	28 x 11	140 x 35	13	18 x 5	130 x 34	13	18 x 5	18 x 5	38.5
Model no.	3101519		3101450		3101390			3101187			3101797	3101188

## OMEGA classiX® and All-steel bar clamps (up to version 30.06.09) – Classic Profile

GS16K GS12-8K								110 x 30	10	14 x 4	16 x 4	25.5
Model no.								3101179			3101795	3101180
GS20K RSC-8	100	19.5 x 9.5	100	19.5 x 9.5	112 x 30	12	16 x 4	110 x 30	12	16 x 4	16 x 4	32
Model no.	3101422		3101800		3101386			3101182			3101796	3101183
SQ-4 J18-8 GS25K GS16-12K	120	22 x 10.5	120	22 x 10.5	125 x 32	12	16 x 4	130 x 34	12	16 x 4	16 x 4	32
Model no.	3101423		3101801		3101389			3101186			3101796	3101183
1200S-12 GS30K RSC-12	140	25 x 12	140	25 x 12	140 x 35	13	18 x 5	130 x 34	13	18 x 5	18 x 5	38.5
Model no.	3101424		3101802		3101390			3101187			3101797	3101188
1200S-8 GS60K RSC-18 RSC-24	120	25 x 12	120	25 x 12	140 x 35	13	18 x 5	130 x 34	13	18 x 5	18 x 5	38.5
Model no.	3101425		3101803		3101390			3101187			3101797	3101188
SGL	120	27 x 13	120	27 x 13	140 x 35	13	18 x 5	130 x 34	13	18 x 5	18 x 5	38.5
Model no.	3101426		3101804		3101390			3101187			3101797	3101188

# BESSEY® 2019 Accessories & spare parts

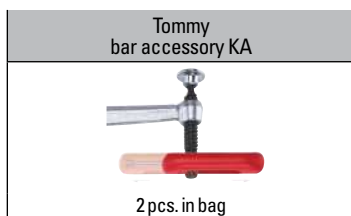



## suitable for:

TG & TB, RSC-8, 660S, SQ-4

Model no.	3101194
-----------	---------

RSC-12, RSC-18, RSC-24, 1200, SQ, SGL, SG30VAD, 2400

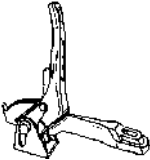
Model no.	3101195
-----------	---------

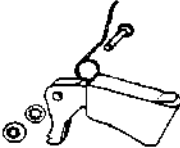
Sliding arm cpl.		Lever pressure plate cpl.	Trigger cpl.
			
Throat depth mm	For rail mm	Bolt Ø x 1 mm	2 pcs. in bag Bolt Ø x 1 mm

## Lever clamps (version 01.03.10) for LC series – New Profile

LC4				5h11 x 21
Model no.				3101399
LC8	100	22 x 8.5	10 x 33.5	5h11 x 26
Model no.	3101522		3101397	3101400
LC12	140	28 x 11	12 x 38	5h11 x 26
Model no.	3101524		3101398	3101401
LC20 LC31	120	28 x 11	12 x 38	5h11 x 26
Model no.	3101525		3101398	3101401

## Lever clamps (up to version 28.02.10) for GSH series – Classic Profile

GSH12/LC-4				5h11 x 21
Model no.				3101399
GSH20/LC-8	100	19.5 x 9.5	10 x 33.5	5h11 x 26
Model no.	3101333		3101397	3101400
GSH30/LC-12	140	25 x 12	12 x 38	5h11 x 26
Model no.	3101335		3101398	3101401
GSH50/LC-20	120	25 x 12	12 x 38	5h11 x 26
Model no.	3101336		3101398	3101401

# BESSEY® 2019 Accessories & spare parts

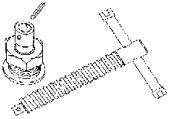



Sliding arm cpl.		Kombi set (screw, pressure plate cpl. & pressure pin)	
			
Throat depth mm	For rail mm	Acme thread mm	Tommy bar Ø x length mm

## High performance clamps (version 01.07.08) – New Profile

1800	120	28 x 11	18 x 5	10 x 120
Model no.	3101521		3100398	
2400	140	34 x 13	20 x 5	11 x 120
Model no.	3101407		3100399	

## High performance clamps (up to version 30.06.08) – Classic Profile

1800, GSL	120	27 x 13	18 x 5	10 x 120
Model no.	3101338		3100398	
SQ	120	30 x 15	20 x 5	11 x 120
Model no.	3101329		3100399	
2400, GSM	140	30 x 15	20 x 5	11 x 120
Model no.	3101330		3100399	
DT 2400	200	30 x 15	20 x 5	11 x 120
Model no.	3101331		3100399	
4800	175	40 x 20	22 x 5	11 x 180
Model no.	3101332		3100400	
7200	200	50 x 25	M24	18 x 345
Model no.	3101798		3100401	
8500	100	40 x 20	22 x 5	11 x 180
Model no.	3100753		3100400	
SG30VAD	120	30 x 15	20 x 5	11 x 120
Model no.	3101724		3100399	

Regular high performance pressure plate		Rough surface high performance pressure plate		V-groove high performance pressure plate		Socket/ bushing with spring ring	Wedge 7200S
							
Screw hole mm	Pin mm	Screw hole mm	Pin mm	Screw hole mm	Pin mm	Thread mm	2 pcs. in bag

## High performance clamps

SGL, SQ, 1800, 2400, 4800, 8500	12	5 x 20	12	5 x 20	12	5 x 20	
Model no.	3100736		3101192		3101193		
7200 + any spindle that accepts a regular MorPad	12	5 x 20				M24	
Model no.	3100737					3100579	3101788

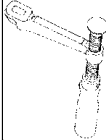
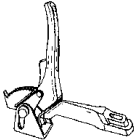
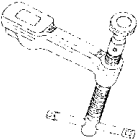
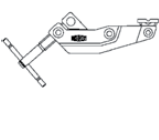
Rail		Wooden handle cpl.		Lever clamp cpl.		Tommy bar cpl.		Gripping arm cpl.	
									
Opening mm	Rail mm	Throat depth mm	For rail mm	Throat depth mm	For rail mm	Throat depth mm	For rail mm	Throat depth mm	For rail mm

## Versatile clamp set 3m opening (up to version 31.03.2015)

SLV100M			120	28 x 11	120	28 x 11	120	28 x 11	120	28 x 11
Model no.			3101519		3101525		3101521		3101590	
SLV100M			140	28 x 11	140	28 x 11				
Model no.			3101518		3101524					
SLV150M			120	28 x 11	120	28 x 11	120	28 x 11	120	28 x 11
Model no.			3101519		3101525		3101521		3101590	
SLV150M			140	28 x 11	140	28 x 11				
Model no.			3101518		3101524					
SLV200M			120	28 x 11	120	28 x 11	120	28 x 11	120	28 x 11
Model no.			3101519		3101525		3101521		3101590	
SLV200M			140	28 x 11	140	28 x 11				
Model no.			3101518		3101524					
GSV200M	3000	30 x 15					120	30 x 15		
Model no.	3101612						3101329			
GSV200M	3000	30 x 15					140	30 x 15		
Model no.	3101612						3101330			
GSV200M	3000	30 x 15					200	30 x 15		
Model no.	3101612						3101331			

## Versatile clamp set 3m opening (from version 01.04.2015) – Classic Profile

SLV100M	1000	27 x 13	120	27 x 13	120	27 x 13	120	27 x 13		
Model no.	3101731		3101426		3101337		3101338			
SLV150M	1500	27 x 13	120	27 x 13	120	27 x 13	120	27 x 13		
Model no.	3101732		3101426		3101337		3101338			
SLV200M	2000	27 x 13	120	27 x 13	120	27 x 13	120	27 x 13		
Model no.	3101733		3101426		3101337		3101338			
GSV200M	3000	30 x 15					120	30 x 15		
Model no.	3101612						3101329			
GSV200M	3000	30 x 15					140	30 x 15		
Model no.	3101612						3101330			
GSV200M	3000	30 x 15					200	30 x 15		
Model no.	3101612						3101331			

## SLV/GSV rail end stop fastener set

SLV / GSV	
Model no.	3101782

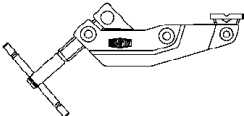
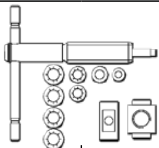

# BESSEY® 2019 Accessories & spare parts

Sliding arm cpl.		Screw cpl.	
			
Throat depth mm	For rail mm	Acme thread mm	Tommy bar Ø x length mm

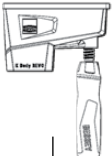

## Claw clamp (version from 01.04.12)

CL24	120	28 x 11	18 x 5	8 x 110
Model no.	3101590		3101562	

Sliding arm cpl. with plastic case	
	
Throat depth mm	For rail mm

## K-Body clamps KR / KRV / KRE / KREV

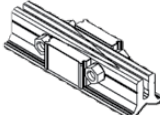
KR...-2K KRV...-2K	85	29 x 9
Model no.	KRE-J2K	

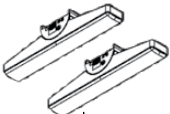
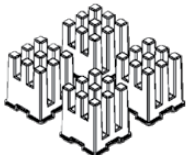
Extender	Variable Jaw	Tilting adapter	Framing set
			
		Jaw width mm	Jaw height mm

## K-Body clamps KR / KRV

K...				
Model no.	KBX20	KRE-V0		KP
KR...-2K KRV...-2K			170	25
Model no.	KBX20	KRE-V0	KR-AS	
				KP

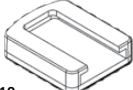

Protection cap set.	Protection cap set.
 <p>5 pairs Ø mm</p>	 <p>10 pcs.</p>

## One-handed clamp Power Grip

PG	32	
Model no.	3101402	
EZS		40 x 48
Model no.		3101841

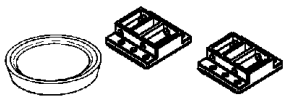
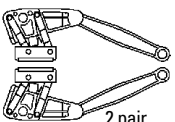
Repair kit	Jaw cpl. with push rod
 <p>3 pairs x large jaws, 3x protection caps</p>	 <p>2 pair</p>

## One-handed edge clamp EKT

EKT55	3101403	3100998
-------	---------	---------

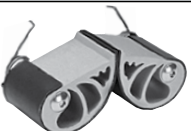
Jaws
 <p>1 pair including spring</p>

## Kantenfix KF and panel carrier KFP

KF2	4102100
KF4	4102056
KFP	4102057

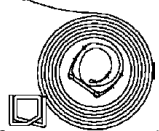
Clamping strap spare part / enlarger
 <p>Strap 7100 mm, 2 buckles</p>

## Band clamps VAS-23

VAS-23	3100832
--------	---------

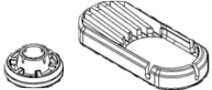
Pressure plate with protection cap
 <p>5 pairs Ø mm</p>

## GearKlamp GK



GK	26
Model no.	3101840

# BESSEY® 2019 Accessories & spare parts



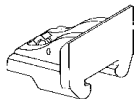

## Grip pliers SG

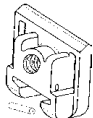
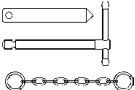
SG4, SG8	3100576	
SG24-PC		3101547

Pressure jaw TB		Screw guide	Clamplng jaw	Screw set TB
				
Jaw width mm	Jaw height mm	Acme thread mm		

## Sash clamps TB

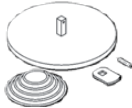
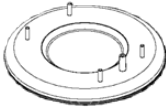
TB	68	48	18 x 5		
Model no.	3101793	3101792	3100920	3101405	

Vacuum adapter	Rubber pad	Handle
 Ø mm	 Ø mm	

## Seaming tools PS

PS55	120		
Model no.	3101839		
PS120		210	
Model no.		3101685	3101686

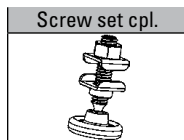

## Toggle clamps STC

STC-VH20 STC-HH20 STC-HV20 STC-HA20 STC-IHH15 STC-IHA20	3101627
STC-VH50 STC-HH50 STC-IHH25	3101589
STC-HH70	3101588

Rail		Cross holder cpl.	2K handle cpl.		Tommy bar cpl.		Lever handle cpl.	
Opening mm	Rail mm		Throat depth mm	For rail mm	Throat depth mm	For rail mm	Throat depth mm	For rail mm

## Table welding clamps TWV

TWV16	200	22 x 8 ½	22 x 8 ½	- 150	22 x 8 ½	- 150	22 x 8 ½	- 150	22 x 8 ½
Model no.	3101740		3101744	3101741		3101742		3101743	
TWV28	300	28 x 11	28 x 11	40 - 175	28 x 11	40 - 175	28 x 11	110 - 175	28 x 11
Model no.	3101706		3101710	3101707		3101708		3101709	

## Table welding clamps TW

TW16	200	22 x 8 ½		100	22 x 8 ½	100	22 x 8 ½	100	22 x 8 ½
Model no.	3101740			3101516		3101441		3101522	
TW28	300	28 x 11		120	28 x 11	120	28 x 11	120	28 x 11
Model no.	3101706			3101519		3101450		3101525	
TW28	300	28 x 11		140	28 x 11	140	28 x 11	140	28 x 11
Model no.	3101706			3101518		3101447		3101524	

Tommy bar cpl.		Regular high performance pressure plate		Rough surface high performance pressure plate		V-groove high performance pressure plate		Rail		Arm	
Throat depth mm	For rail mm	Screw hole mm	Pin mm	Screw hole mm	Pin mm	Screw hole mm	Pin mm	Opening mm	Rail mm	Throat depth mm	For rail mm

## Table welding clamps TWM28

TWM28	120	28 x 11	12	5 x 20	12	5 x 20	12	5 x 20
Model no.	3101521		3100736		3101192		3101193	

## Table welding clamps TWGRS

TW28GRS								200	22 x 11	120	28 x 11
Model no.								3101706		3101590	



### Extension

Opening Ø	Adj.
-----------	------

## Table welding clamps TWVAD / TWA-STC / TW28AV

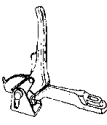
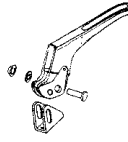
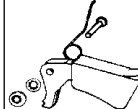

TWVAD, TW16VAD, TW16A-STC	16	15-200
Model no.	TW16X	
TWVAD, TW28VAD, TW28A-STC, TW28AV	28	15 - 300
Model no.	TW28X	

# BESSEY® 2019 Accessories & spare parts

Clamping arm	Pressure shoe	Spindle	Sliding arm cpl.	Lever with pressure cap cpl.	Trigger cpl.
	 4 pcs. in bag	 2 pcs. in bag	 Throat depth mm   For rail mm	 Bolt Ø x 1 mm	 2 pcs. in bag Bolt Ø x 1 mm



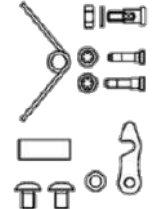

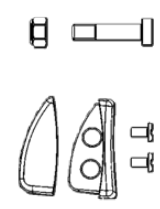
## Machine table clamps BAS, BS, SGHS

BAS... 9-4	3101428	3101431	3101726			
BAS... 10-6	3101429	3101431	3101726			
BSP... 10-6	3101430		3101726			
BS2N/BS3N 1200HD-9 Model no.						5h11 x 26 3100747
BS4N Model no.						5h11 x 26 3100748
BS6N, 1800L, 2400HD-10 Model no.				140 3101432	30 x 15 12 x 38 3101029	

Repairing set 08/22A 27/29/123S	Repairing set 16	Lower hold complete 123S
		



## Compound leverage snips

D22A, D27AH	R032		
D16, D16L, D16S		R030	
D27, D29	R001		
D123 S	R001		R042

Standard blade	Hook blade	Linoleum blade	Scoring blade
 10 pcs.	 10 pcs	 5 pcs	 5 pcs

## Folding utility knife

DBKPH, DBKWH, DBKAH	DBK-T	DBK-H	DBK-L	DBK-A
---------------------	-------	-------	-------	-------

Replacement blades	Spare mould
	

## Nibbler

D24	D241	Model no. D242
-----	------	----------------

# BESSEY® Solutions

Woodworking, 2019



Simply better.

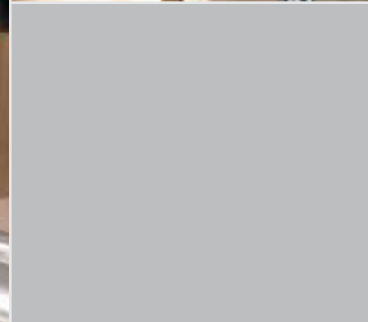



# Woodworking solutions



Simply better.

## Parallel Clamp, K Body®

- Parallel clamping with nominal 1700 lbs of force
- Capacities from 12" to 98"
- Cold drawn steel rail from Germany
- Easy to grip handle
- Precise and powerful clamping



## Parallel Clamp, Vario K Body®

- All the precision and power of REVO, plus more
- A complete parallel clamp system – mix and match
- Add jaws with handles, moveable fixed jaws
- Connect clamps together to make extra-long clamps
- Add accessories to do angles or create fixtures



## Parallel Clamp, REVO™ JR

- The mid-sized version of what makes the REVO great
- Parallel clamping with nominal 900 lbs of force
- Capacities from 12" to 50"
- Traditional wood handle
- Competitive price point



## Bar Clamp, TG series, 2K handle

- The original professional bar clamp
- Steel rail from Germany
- Capacities from 6" to 79"
- Malleable cast jaws, non-slip
- Two component handle for easy grip



## Bar Clamp, TG series, Wood handle

- The original professional bar clamp
- Steel rail from Germany
- Capacities from 6" to 48"
- Malleable cast jaws, non-slip
- Traditional wooden handle



# Woodworking solutions



Simply better.

## GearKlamp®, GK

- Works "BIG" in a small space
- Handle is integrated into the rail
- Ideal for hard to reach clamping applications
- Capacities from 6" to 24"
- Nominal clamping force of 450 lbs



## One Hand Clamp, EZS series

- One handed clamping or spreading
- Large, non-marring pressure caps
- German engineering
- Capacities from 6" to 36"
- Nominal clamping force of 445 lbs



## One Hand, DuoKlamp®

- One handed clamping or spreading
- Large surface area for clamping
- Unique, handle parallel to the rail
- Capacities from 6" to 24"
- Nominal clamping force of 260 lbs



## One Hand Clamp, PG series

- One handed clamping
- Large surface area for clamping
- Rated at 1000 lbs of clamping force
- Capacities of 12" and 24"
- All steel rail, professional grade



## EHK Trigger Clamp

- One handed clamping or spreading
- Large, non-marring pressure caps
- Up to 600 lbs. of potential clamping force
- Easy release mechanism
- Capacities from 4 1/2" to 50"





# Woodworking solutions



Simply better.

## Clutch Clamp, GSCC series

- Clutch style bar clamp
- Competitively priced DIY bar clamp
- Non-marring plastic caps
- Easy to grip 2K handle
- Capacities from 6" to 36"



## Clutch Clamp, DHBC series

- Double headed clutch style bar clamp
- Competitively priced DIY bar clamp
- Non-marring plastic caps
- Easy to grip, wood handle
- Capacities from 12" to 36"



## Strap Clamp, VAS series

- Professional grade strap clamp
- Up to 23 feet of reinforced strapping
- Integrated coiling mechanism
- Practical vario corners
- Easy to grip, 2 component handle



## Angle and Miter Clamps, WS-3+2K and WS-1

- 90 degree clamping
- For clamping angles and miters or butt joints
- Sturdy die-cast frames
- Variable jaws allow for clamping flexibility
- Easy to grip, 2 component handle (WS-3+2K)



## Lever Clamp, KliKlump®

- Light duty lever clamp
- Sturdy magnesium arm
- Vibration resistant lever mechanism
- Easy release mechanism
- Five times (5x) faster than a bar clamp





# Woodworking solutions



Simply better.

## Pipe Clamp, PC34-2 series

- Traditionally styled pipe clamp
- ½" and ¾" versions available
- Extra high base to save knuckles
- Smooth ACME spindle
- Broad foot assembly for balance



## Pipe Clamp, BPC-H34 series

- H Series styled pipe clamp
- ½" and ¾" versions available
- Extra high, 2 footed based to save knuckles
- Smooth ACME spindle
- Broad foot assembly for balance

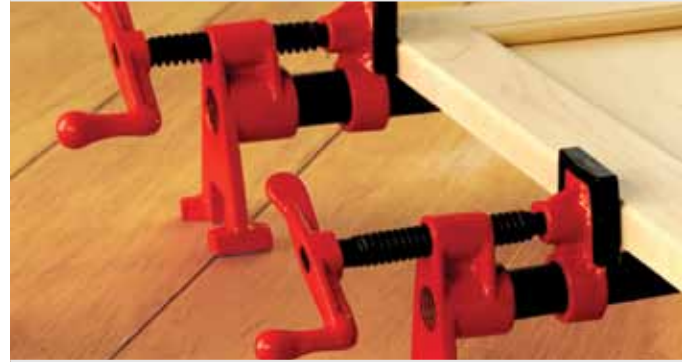

## Variable Spring Clamp, XV5-100

- Variable spring clamps from BESSEY
- Variable pressure and range of opening
- Ergonomic, 2 component handles
- Soft, pivoting, non-marring tips
- One of a broad series of plastic spring clamps



## Ratcheting Spring Clamp, XCRG

- Ratcheting spring clamps
- Heavy duty resin construction
- Rapid action for quick set up
- Large opening for quick set up
- Quick release mechanism



## Steel Spring Clamp, XM3

- Sizes available are 1, 2, 3 and 4 In
- Available ; spring clamps with tips and handles
- Available; spring clamps with no tips or handles
- Available; black spring clamps with tips and handles
- Heavy duty spring for quick set up





# BESSEY® Solutions

Machine Tool, 2019



Simply better.

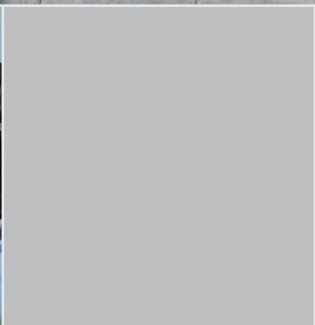
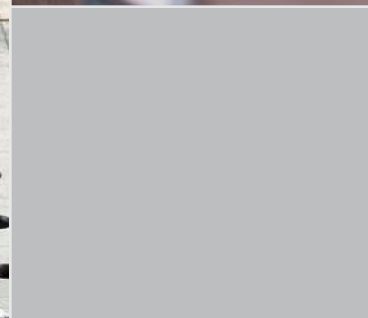
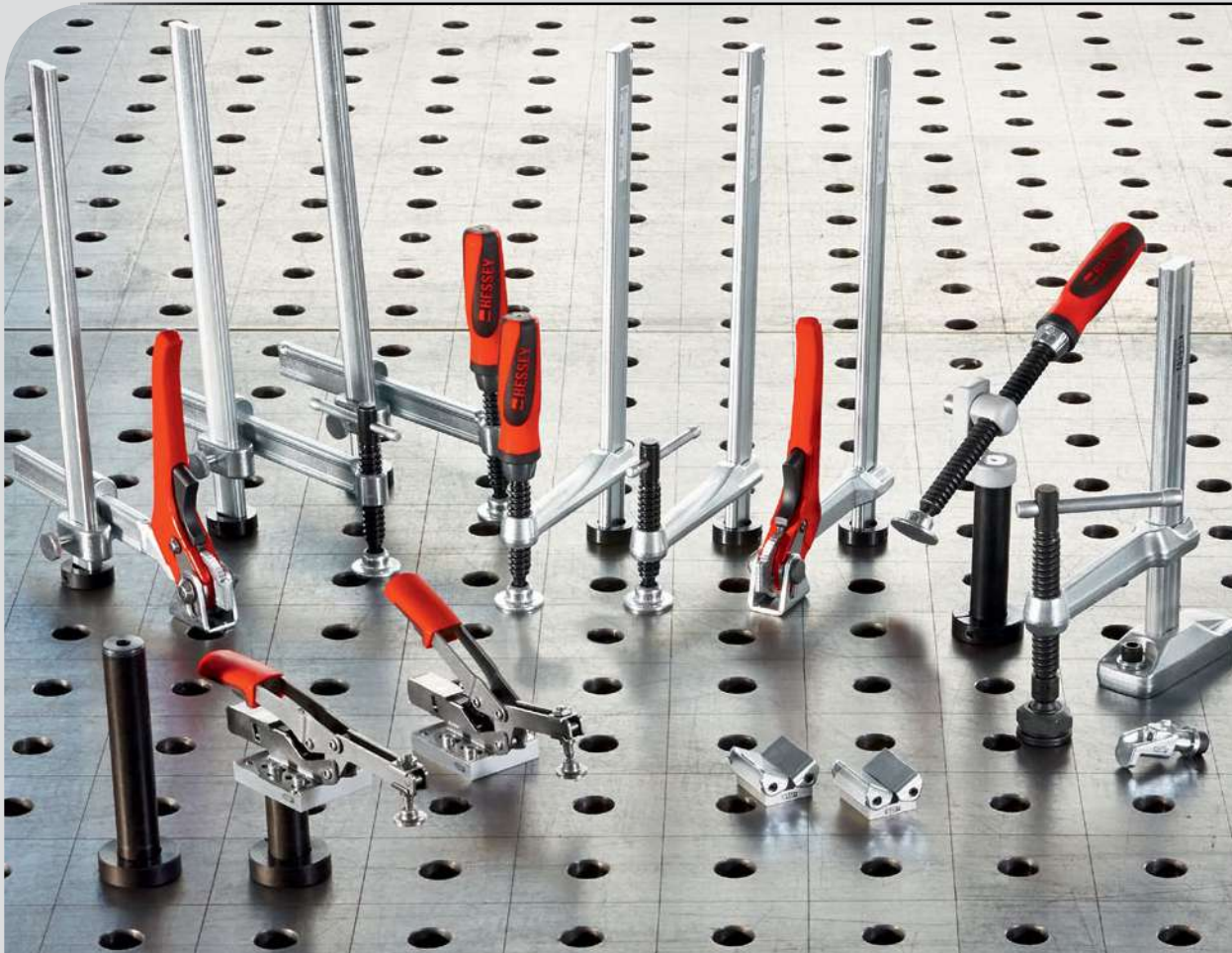



# Machine tool solutions



Simply better.

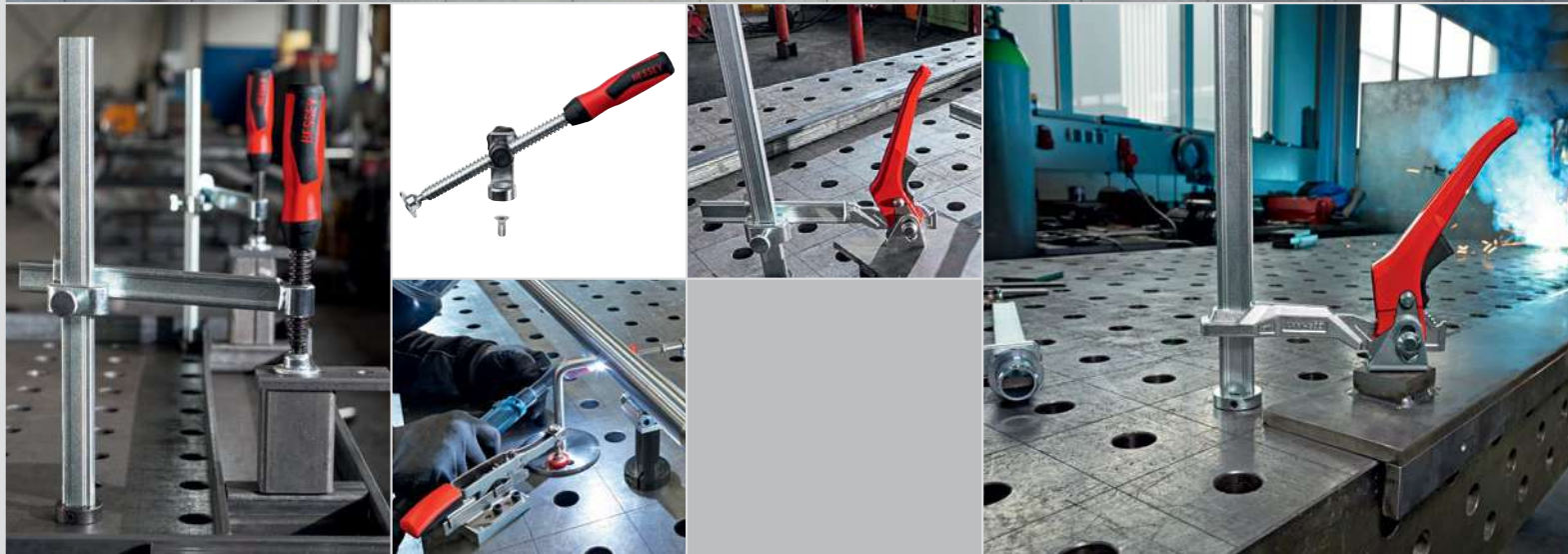

## Bringing our experience to the table

Clamping elements for welding tables with 28 mm or 16 mm matrix holes. Choose from 3 handle designs for standard elements, plus variable or fixed throat depth versions. Our line-up also includes a clamping element with heat-resistant pressure plate, a gripping arm variant for easy work area access, and attachments for clamping oval, round and square workpieces.

BESSEY® toggle clamps and work table clamps can be used on welding tables thanks to special adapters, extensions and attachments. All elements can integrate into the table without using tools, making them highly adaptable with comfortable, safe and precise operation. Try them for yourself!

### 1 Flexible throat depth

The BESSEY® TWV series has a range of throat depths from 1 3/8" up to 6 7/8" and is available in 3 handle variants.

### 2 Fixed throat depth

TW series has a range of throat depths from 4" up to 5 1/2" and is available in 3 handle variants.

### 3 Heavy-duty, custom design

TWM28 with heat-resistant special pressure plate and sintered steel insert, can pivot up to 35°. TW28GRS gripping arm features a spindle located outside the work area.

### 4 Flexible accessories

TW28VAD and TWWAD vario table clamping attachments are ideal for irregularly shaped workpieces. They are infinitely adjustable to the workpiece being welded, from 60° internal to 60° external.

### 5 Accessories for BESSEY®'s Toggle Clamp

The TW28A-STC adapter and TWX extension allow BESSEY® toggle clamps with horizontal base plates to be used on welding tables.

### 6 Diagonal and horizontal clamping

Tilting adapter TW28AV used in conjunction with TW28X allows flexible clamping from -52° to +52°.

### 7 Quick conversion of existing table clamps for welding table use

Convert existing BESSEY® machine table clamps by screwing the TW28HO attachment into the hole on the bottom of the hold down clamp for use on matrix tables.



# Machine tool solutions



Simply better.

## Welding Table Clamp Variable Throat Depth

- TWV Series
- 28mm and 16mm offerings
- Precise clamping with easy height adjustment and variable throat depth
- Patented rail profile for enhanced strength
- Drop forged sliding arm for strong, dependable clamping
- Choice of three handle variants

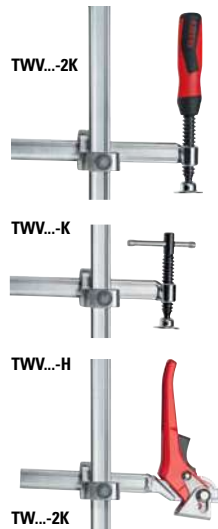

## Welding Table Clamp Fixed Throat Depth

- TW Series
- 28mm and 16mm offerings
- Precise clamping with easy height adjustment and fixed throat depth
- Patented rail profile for enhanced strength
- Drop forged sliding arm for strong, dependable clamping
- Choice of three handle variants



## Welding Table Clamp, Special Pressure Plate, TWM28

- Precise, individual clamping
- Tempered profiled rail and drop forged sliding arm for strength where it is most needed
- Long life due to heat-resistant pressure plate with sintered steel insert, which can be tilted up to 35°
- Patented rail profile for enhanced strength
- Drop forged sliding arm for strong, dependable clamping



## Welding Table Clamp, TW28GRS

- Spindle located on the outside for access to the work area and to protect against welding spatter
- Special, sturdy V-grooved pressure plate, for round or square workpieces
- Pivotal and infinitely adjustable in terms of height
- For the tightest of spaces, narrow openings and short projections



# Machine tool solutions



Simply better.

## Welding table clamp accessories, TWWAD

- Specifically adapted to round, oval and square workpieces
- Angle infinitely adjustable from 60° internal to 60° external
- TW16VAD / TW28VAD versions with bolt for rapidly aligning and fixing the workpiece to the welding table
- TWWAD without bolt for variable movement on the welding table – 2 pieces per bag



## Welding table toggle clamp adapter, TW-STC

- Accessory for BESSEY® STC toggle clamp with horizontal base plate
- With bolt – for use directly on the welding table
- Without bolt – for screwing to the extension TWX



## Welding table clamp extension, TWX

- Accessory for BESSEY® toggle clamp adapter TW28A-STC and TWWAD
- Lowering of round workpieces is infinitely adjustable using the adjusting ring in the table
- Use with TWWAD – requires one 8 x 40 mm flat head screw



## Welding table clamp tilting adapter, TW28AV

- Accessory for BESSEY® extension TW28X
- Pivoting spindles with stepless adjustment from -52° to +52°
- Lockable trapezoidal nut for secure fastening of the workpiece
- High quality, 2-component plastic grip with 6 7/8" long spindle



## Welding table clamp attachment, TW28HO

- Accessory for Bessey hold down clamps. See pages 7 & 8
- Quick attachment for use with matrix tables
- For use as an accessory with clamp

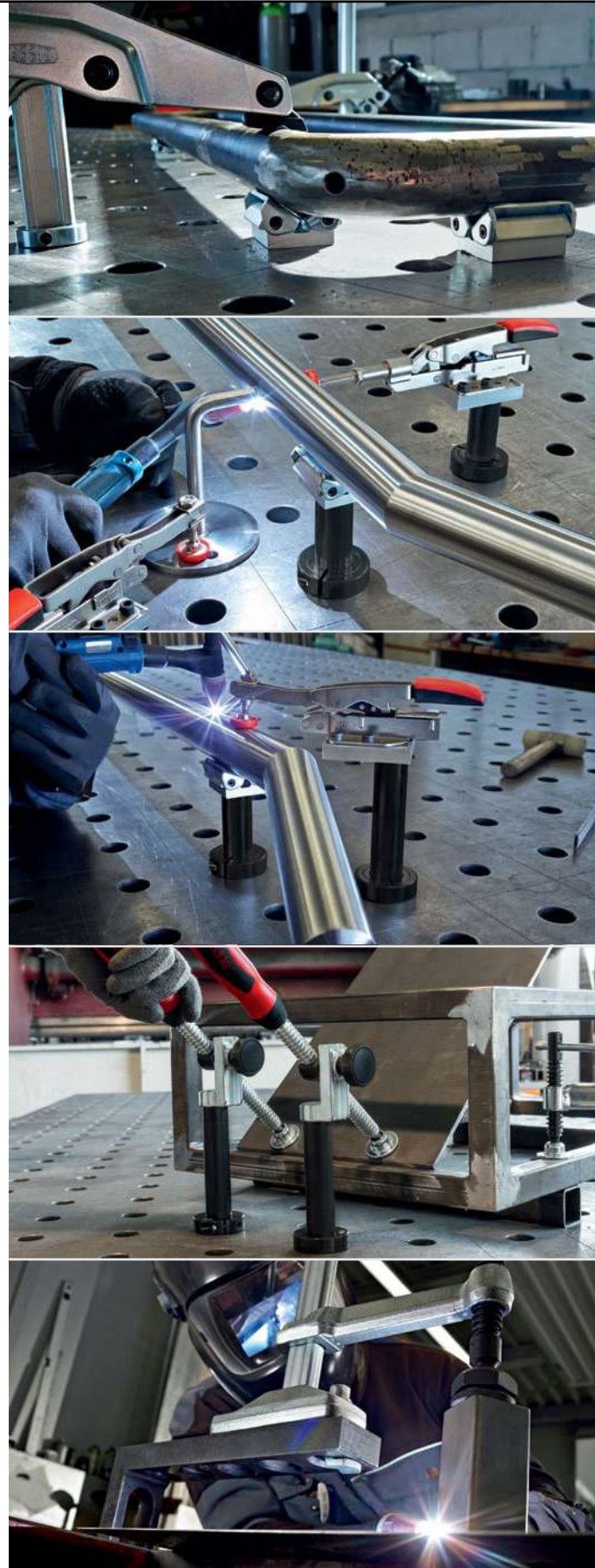



# Machine tool solutions



Simply better.

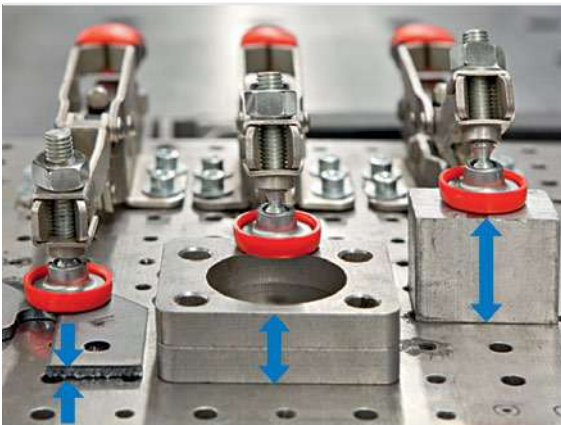

Optional Bases

## Auto-adjust toggle clamps for rapid clamping

One BESSEY® Auto-Adjust Toggle Clamp replaces a range of competitive clamps for quicker setups, smaller tool cribs and consolidated inventories.

- 1 Auto-adjustment of the jaw height**  
The BESSEY® Auto-Adjust Toggle Clamp self adjusts to variations in workpiece height while maintaining clamping force.
- 2 Adjustable clamping force**  
The integrated clamping force adjustment screw can vary the applied clamping force in a range.
- 3 Adaptable base plate:**  
Holes are sized and spaced for easy mounting and flexibility in metric and imperial.
- 4 Large ergonomic handle**  
Soft insets for maximum comfort.

# Machine tool solutions



Simply better.

- Automatic and infinitely variable adjustment of the clamping height while clamping force remains unchanged – without having to make manual changes to the position of the pressure screws
- Adjustable clamping force based on the adjusting screw in the joint
- Base plate hole pattern suitable for millimetres and inches

## Vertical toggle clamp with open arm STC-VH

	Opening	Nominal Clamping Force	Holding Capacity	Approx. Weight	Fastener
STC-VH20	1 <sup>3</sup> / <sub>16</sub> "	25 - 250 lbs.*	450 lbs.	0.44 lbs.	3/16" or M5
STC-VH50	1 <sup>9</sup> / <sub>16</sub> "	25 - 550 lbs.*	700 lbs.	0.77 lbs.	1/4" or M6



STC-VH

## Horizontal toggle clamp with open arm STC-HH / STC-HV / STC-HA

- High-quality oil-resistant two-component plastic handle with slip protection

	Opening	Nominal Clamping Force	Holding Capacity	Approx. Weight	Fastener
<b>with horizontal base plate</b>					
STC-HH20	1 <sup>3</sup> / <sub>16</sub> "	25 - 250 lbs.*	450 lbs.	0.44 lbs.	3/16" or M5
STC-HH50	1 <sup>9</sup> / <sub>16</sub> "	25 - 550 lbs.*	700 lbs.	0.77 lbs.	1/4" or M6
STC-HH70	2 <sup>3</sup> / <sub>8</sub> "	25 - 550 lbs.*	700 lbs.	0.86 lbs.	1/4" or M6



STC-HH

### with vertical base plate

STC-HV20	1 <sup>3</sup> / <sub>16</sub> "	25 - 250 lbs.*	450 lbs.	0.55 lbs.	3/16" or M5
----------	----------------------------------	----------------	----------	-----------	-------------



STC-HV

### with angled base plate

STC-HA20	1 <sup>3</sup> / <sub>16</sub> "	25 - 250 lbs.*	450 lbs.	0.52 lbs.	3/16" or M5
----------	----------------------------------	----------------	----------	-----------	-------------

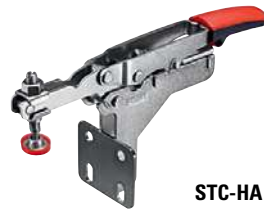

STC-HA

## Push/pull clamp STC-IHH / STC-IHA

- High-quality oil-resistant two-component plastic handle with slip protection

### with horizontal base plate

STC-IHH15	3/8"	25 - 250 lbs.*	450 lbs.	0.52 lbs.	3/16" or M5
STC-IHH25	5/8"	25 - 550 lbs.*	700 lbs.	0.86 lbs.	1/4" or M6



STC-IHH

### with angled base plate

STC-IHA15	3/8"	25 - 250 lbs.*	450 lbs.	0.55 lbs.	3/16" or M5
-----------	------	----------------	----------	-----------	-------------



STC-IHA





# Machine tool solutions



Simply better.



## Instant & easy to apply clamping force

### 1 Flexible in application

BESSEY hold down clamps offer a range of flexible clamping solutions in differing configurations.

### 2 Rapid in application

The BSN offers a lever mechanism that facilitates quick clamping and releasing. Resure pads self-adjusts on the work piece.

### 3 In the tightest space

When unobstructed access to the work area is a requirement or when clamping has to be done in confined spaces, the claw machine clamp MCL provides the necessary function thanks to an externally-positioned spindle.

### 4 Special tilting pressure plate

The BSG work table clamp has a heat-resistant pressure plate which is replaceable and can be tilted up to 35° so it can even clamp on angled or sloping surfaces. It has an extremely long service-life due to the oil-soaked sintered steel insert's excellent sliding and emergency running properties.



# Machine tool solutions



Simply better.

## Hold down table clamp

- Clamping force up to 2220 lbs
- Tilting and infinitely height-adjustable
- For drilling and light milling work
- Lever mechanism for rapid clamping and release



## Claw machine clamp, MCL

- Clamping force up to 1450 lbs
- A cantilever jaw for clamping in tight spaces with the screw positioned outside of work area
- Externally-positioned spindle to allow unobstructed access to the work area and clamping in confined spaces
- For drilling and light milling work



## Hold down clamp, BSG21-14

- Vibration proof, ratchet action for rapid clamping
- Pressure pad self-adjusts on the workpiece
- Drop forged steel clamping arm
- Mounting hole accepts 5/8" bolts



# Machine tool solutions



Simply better.

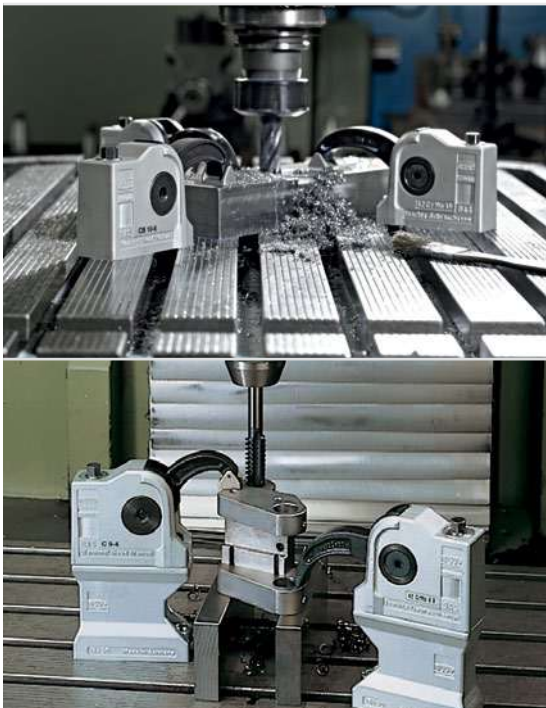

## Extra-high clamping pressure, space saving design

### 1 Housing is heat-treated CrMo

BAS clamps are approx. 30% smaller than the competitors while maintaining the same high clamping force. The self-locking worm gear unit exerts up to 3600 lbs of clamping force.

### 2 Clamping arms with aluminum pressure pads

Smooth and efficient with optimum weight distribution. The short and long clamping arms are equipped with a swivelling aluminum pressure pad. A polyamide seal protects the interior against dirt.

### 3 Open or closed mounting holes

Clamp and unclamp quickly with open hole models. In closed versions, the screw, nut and clamp form a unit. All BAS clamps are easily fastened and released.

### 4 Space saving and adjustable

All BAS models feature a compact design in height and in surface. Clamping height can be increased with the BESSEY® BASO base unit, but care must be taken to provide precise workpiece contact surfaces.



# Machine tool solutions



Simply better.

## BAS-C compact clamp, fixing hole open

- Clamping force up to 3600 lbs
- Space-saving design
- Fixing hole open for M 10 / M 12

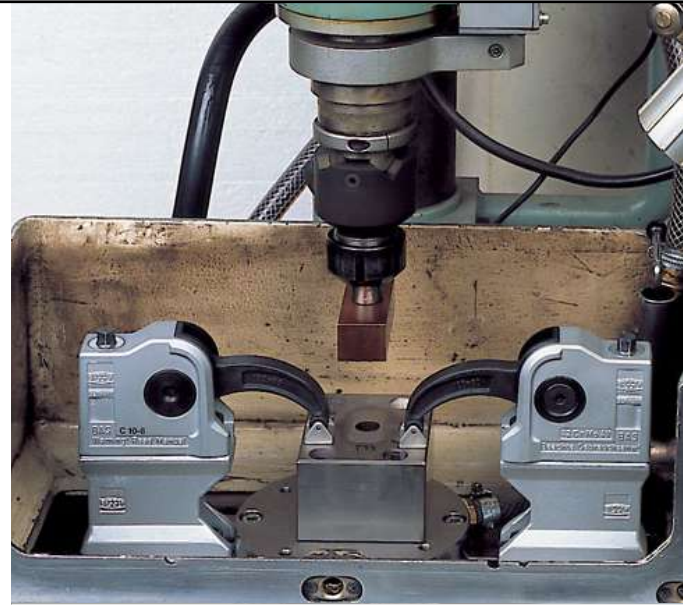
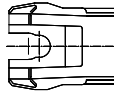

## BAS-CB compact clamp, fixing hole closed

- Clamping force up to 3600 lbs
- Space-saving design
- Fixing hole closed for M 10 / M 12

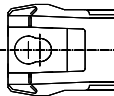

## Base unit BASO

- 80 mm extension
- Stackable
- Fastening hole open, including cheese head screw
- Suitable for all BESSEY BAS clamps



# Machine tool solutions



Simply better.

## RiteHite Hold Down Products

- A quick and easy set-up, ready for your T-slot table. A value-priced hold down alternative with the great BESSEY® quality you expect.
- Single component design – Self-positioning, single component design for a quick set-up.
- Workpieces of different thicknesses – Wide clamping range. Adjustments up to 5”.
- T-slot table ready, for T-slot hold down tables in machine shop applications.
- Sturdy frame – Strong, ductile iron body, strength.
- Swivel rocker attached to body allows the clamp to self-align on the work piece.



## RiteHite Long Reach, Model L

- L series for a longer throw



## RiteHite Standard Reach, Model S

- S series is slightly smaller than its counterpart but with the strength you can depend on

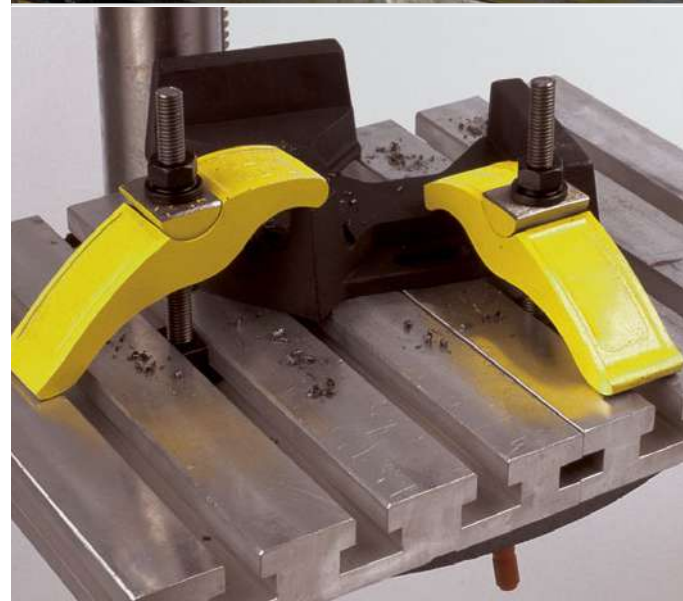

# Complete solutions



Simply better.

## Double force all steel clamps (SLV/GSV)

- Modular design for the widest range of applications
- Clamping force up to 2000 lbs
- Rail lengths from 39 1/2" to 118"



## All steel lever clamps

- Quick – up to 5 times faster than regular clamps
- Secure – unaffected by vibrations
- Strong – high clamping force, up to 1800 lbs
- Non-slip trigger release

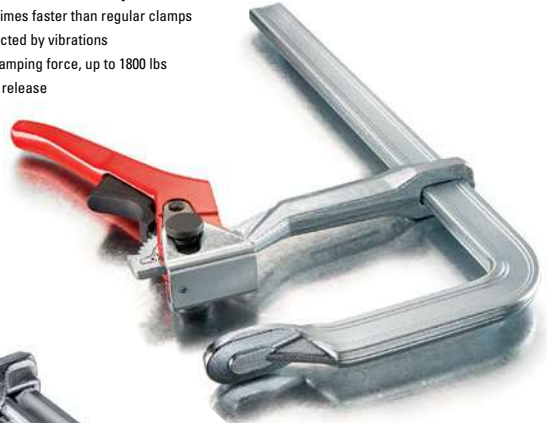

## High performance clamps

- Patented profile rail
- Long lasting MorPad
- Clamping force range from 1980-8500 lbs

## Industrial magnets

### MagWand magnet (MW)

- Collect up to 12 lbs of swarf per pass
- Easily rolls over industrial work surfaces
- Simply dump waste off magnetic insert

### MagSweep (MSP)

- Rolling shop-floor magnet for quick & easy clean up.



## Further clamping tools from the complete BESSEY® range



### Angle clamps (WSM)

- For joining two pieces of metal at an exact 90 degree angle
- WSM does the work – you weld
- Even pieces of different thickness are no match for this clamp.



### classiX® all-steel bar clamps

- Cost effective offering that embodies the stringent quality requirements of BESSEY®
- Range of options: variety of throat depths, pad/swivel styles and clamping capacities for real-world applications
- German engineering – great prices & quality
- Standard & heavy duty pads are field replaceable



### Heavy duty bench vise

- Guaranteed unbreakable\*!
- 90,000 Psi drop forged alloy steel construction
- Perfect parallel jaw design
- Precision ground, induction hardened jaws & anvil
- 360° Rotation drop forged alloy steel swivel base.

\* Guaranteed against breakage in normal use. Conditions apply.



### Portable induction bearing heaters

- Digital temperature and time control
- High performance fast heating with lower energy use
- Vertical or horizontal heating
- Standard cross bars.



### Cone style bearing heaters

- Non-induction
- Small, portable, easy to use!
- Cost effective – includes control box
- NCB version does not have controls.



### Bearing heaters

- Extend bearing life and cut operating cost by eliminating hammering and pounding to cold-mount bearings
- Works on bearings, sprockets, gears, couplings and sleeves
- Demagnetizes bearings – easy to use, ready in minutes.



# BESSEY® Solutions

Metalworking, 2019



Simply better.

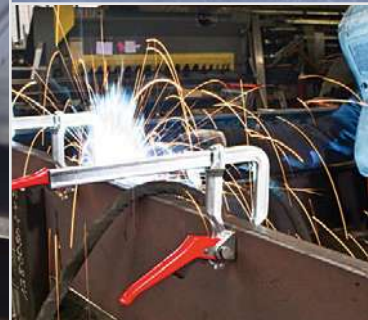



# Metalworking solutions



Simply better.

## Bar Clamp, 1200 series

- Patented profiled rail with standard pads
- Made in Germany
- Sizes from 4" to 24"
- Clamping force 400 to 1320 lbs
- Nine times (9x) faster than a c-clamp



## Bar Clamp, 2400S series

- Patented profiled rail with MorPad
- Made in Germany
- Sizes from 8" to 60"
- Clamping force 1980 to 4880 lbs
- Nine times (9x) faster than a c-clamp



## Bar Clamp, Deep Throat

- Extra deep throat depth, with MorPad
- Made in Germany
- Size of 12" and 24", 8" throat depth
- Clamping force of 1770 lbs
- Nine times (9x) faster than a c-clamp



## Bar Clamp, 7200S series

- Extra Heavy Duty with MorPad
- Made in Germany
- Sizes from 12" to 36"
- Clamping force of 7770 lbs
- Nine times (9x) faster than a c-clamp



## Bar Clamp, 8500 series

- Extra Heavy Pressure with MorPad
- Made in Germany
- Size of 14" available
- Clamping force of 8500 lbs
- Nine times (9x) faster than a c-clamp



# Metalworking solutions



Simply better.

## Bar Clamp, J series

- Step Over, All Steel Clamps
- Made in Germany
- Size of 10", 12" and 20" Available
- Clamping force of from 880 lbs to 4880 lbs
- Nine times (9x) faster than a c-clamp



## Bar Clamp, CL series

- Cantilevered, claw clamp
- Made in Germany
- 24" capacity, 1775 lbs of clamping force
- Ideal for reaching into difficult areas
- Nine times (9x) faster than a c-clamp



## Bar Clamp, LC series

- Patented profiled rail with lever
- Vibration resistant, Made in Germany
- Sizes from 4" to 31"
- Clamping force 400 to 1800 lbs
- Five times (5x) faster than a bar clamp



## Bar Clamp, Omega series

- Omega Bend profiled rail
- Made in Germany
- Sizes from 8" to 24"
- Clamping force 770 to 1100 lbs
- Vibration resistant



## Bar Clamp, KombiKlump

- Multi purpose all-steel clamp
- Made in Germany
- 12" Size, 2600 lbs clamping force
- Clamps, spreads, angles, pipe
- Attractive price point





# Metalworking solutions



Simply better.

## Angle Clamp, WSM series

- All steel for clamping miters and angles
- 90 degree clamping
- Open work area for secondary work functions
- Stable and solid
- Floating spindles allows for differing work thicknesses



## SuperGrips

- SuperGrip Work Pliers
- Adjustable clamping force
- Adjustable jaw angle
- Moveable sliding arm
- Pipe clamps and deep reach versions available



## Industrial Vises, DF series

- Industrial bench vise, drop forged
- 90,000 psi, alloy steel construction
- 4" to 8" versions available
- Gray cast vises, assorted styles, also available
- DIY and professional selections



## C-Clamp, HS series

- Drop forged, hex head, bridge clamps
- Rated up to 40,000 lbs, variety of capacities
- Also available: regular duty, malleable cast styles
- Also available: Copper spindle, hex head or both
- A selection of professional c-clamps available



## C-Clamp, CM series

- Drop forged DIY clamps for extra strength and value
- Sizes from 1" to 8", clamping force form 750 to 1800 lbs
- Also available, quick release versions
- Also available, double headed c-clamps
- A selection of DIY c-clamps available



# Metalworking solutions



Simply better.

## Bearing Heaters, Cone Style

- Cone style bearing heaters
- Different diameter constructions fit on this
- Safe bearing installation requires heating
- Non-induction style with and without heat control
- Aggressively priced



## Bearing Heaters, Induction

- Induction style bearing heaters
- Vertical or horizontal fast-heating options
- Safe bearing installation requires heating
- Induction styles, time and temperature controls integrated
- For bearing sizes from 44 lbs to 770 lbs



## Bearing Heaters, Induction

- Induction style bearing heaters
- Safe bearing installation requires heating
- On and off switch, simple and sturdy construction
- Pyrometer required for heat monitoring
- For bearing sizes up to 22" in diameter



## Compound Snips, D39

- The next generation of compound snips
- Optimized handle angle for maximum force application
- Sintered steel insert to minimize friction at the joint
- A selection of compound action and multi-purpose snips
- Folding and locking knives available



## Industrial Magnets, WMS series

- Quality magnets for safe and simple set ups
- Like an extra set of hands for welding set ups
- A selection of industrial magnets to choose from
- Available: Magnetic ground clamps, mag sweeps
- Multi angle options to choose





BESSEY® Clamping and Cutting Technology

# Complete catalogue 2019/2020

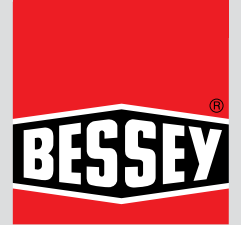

Simply better.

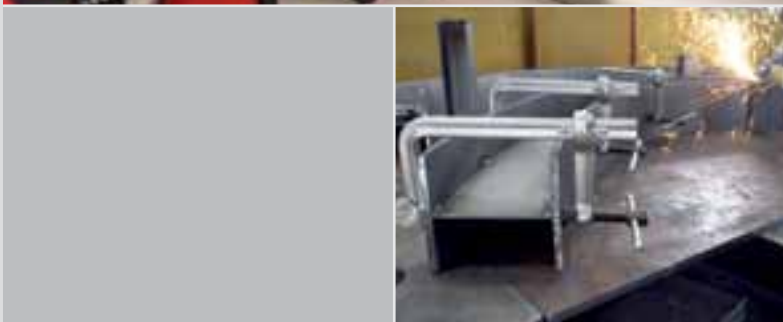



# About BESSEY®

## Innovation with tradition

In 1889 Max Bessey founded BESSEY & Sohn as a bright steel drawing plant. Since then, BESSEY® has continuously expanded the range of products it offers – beginning with the production of manual clamping tools in the mid 1930s. The strength of BESSEY®'s innovation is underlined by numerous patents. In 1979, with the takeover of Diener shears factory, BESSEY® established its cutting technology unit with the already popular Erdi snips.



In 2004 BESSEY & Sohn was spun off into BESSEY Tool GmbH & Co. KG, handling clamping and cutting technology, and BESSEY Präzisionsstahl GmbH, a leading German supplier of high-quality bright and stainless steels. This unique positioning of BESSEY® as a producer of tools and precision steels ensures significant advantages in terms of quality. It allows BESSEY® to procure its rails and spindles

directly from the in-house drawing plant, giving it precise knowledge of the steel quality that is going into particular components which are subjected to particular high stresses. This is because bright steels are produced and tested at BESSEY Precision Steel with consistently high quality and the utmost precision in cutting-edge facilities.

“To stop improving is to stop being good.”  
The motto of company founder Max Bessey remains true today, as it will in the future, and is the guiding principle to everything that the company does.



- 1889** Max Bessey founds drawing plant in Stuttgart.
- 1912** Firm continued by nephew Karl Bessey.
- 1926** Company run by Dr. Mayer who significantly expands product range and adds steel grades.
- 1936** Patent granted for a new malleable cast iron screw clamp, beginning BESSEY clamping tool production.
- 1944** Founding of subsidiary to produce clamping tools.
- 1952** Patent granted for a tempered all-steel clamp.
- 1961** Expansion and start of bright steel production.
- 1966** Dr. Mayer is succeeded by his daughter and son who start dynamic phase of development.
  - Production of bright steel is doubled and complemented by adding stainless steels.
  - New patents and modernized marketing make BESSEY the market leader in global clamping tools.
- 1971** A further increase in bright steel production with the purchase of Aldinger engineering works. Founding of BESSEY FILS from which BESSEY-SER arose in 1988.
- 1979** Purchase of the Diener shears factory.
- 1983** Consolidation of bright steel production.
- 1985** Expansion and purchase of historic spinning mill. After restoration, tool production begins.
- 1989** BESSEY® celebrates its 100 year jubilee.
- 2003** Purchase of sales partner in the strategically important North American market.
 



- 2004** Purchase of the GROSS STABIL TOOL clamping tool brand as part of global growth strategy.
- 2007** Integration of GROSS STABIL TOOL to enhance tool production synergies.
- 2011** Klaus Fuchs becomes Managing Partner and the BESSEY Group is once again owner-managed.
- 2014** BESSEY® celebrates 125 years.





### **BESSEY® locations**

#### **German head offices serving Europe and the world**

BESSEY® Tool GmbH & Co. KG Group are located near Stuttgart, Germany. All production, R&D, along with European admin and sales are located here.

The development, manufacture, storage and shipping of clamping and cutting tools takes place a few km north of the main works, in the building of the historic, former Kammgarnspinnerei Bietigheim-Bissingen (spinning mill).

#### **North American offices serving Canada and the USA.**

With offices in both Canada and the USA, the BESSEY® Group handles the entire North American market in its capacity as a sales and marketing operation.

### **BESSEY® means Quality**

Precision and durability are at the core of the BESSEY® brand. Our tools have always been manufactured from the highest-grade materials. Precision steel rails and spindles are manufactured in our own drawing plant in Germany. All components are tested by experienced technicians and development engineers using ultramodern process control techniques.

### **BESSEY® means Innovation**

“To stop improving is to stop being good.” The motto of our company founder Max Bessey remains true today and is the guiding principle of everything we do. New products and product improvements continue to be developed on a long-term basis from innovative ideas.

### **BESSEY® means Variety**

Thanks to our designers’ many years of experience and continuous communication with customers, BESSEY® has a firm grasp on how to optimize tool ergonomics and efficiency. The result is clamping and cutting tools true to our guiding principle: “BESSEY®. Simply better.” With over 1,600 products, BESSEY® now offers a tremendously wide and deep range of items customised to special requirements.

### **BESSEY® means Service**

Reliability, confidence and a sense of responsibility are the backbone of our partnership with the environment and customers. BESSEY® has distinguished itself as a service-oriented company.



# Table of contents

## 1-2 Premium all-steel bar clamps

- 660-S, 1200-S Light duty
- 1800-S Medium duty
- 2400S Regular duty
- 4800S Heavy duty
- 7200S Extra heavy duty
- 8500HPC Extra high pressure



## 3-5 Traditional all-steel bar clamps

- MMS Light duty
- SGL Medium duty
- SQ Regular duty
- STB Heavy duty
- GS classiX® - Standard pad
- GSL, GSM classiX® - Heavy duty pad
- Service parts for all-steel clamps



## 6 Twist bar clamps



- GK GearKlamp® twist bar clamps



## 7-10 Parallel bar clamp systems and case clamps

- KRE K Body® REVOLUTION
- KREV Vario K Body® REVOLUTION
- KREX K Body® REVO™ extender kits
- KREK K Body® REVO™ framing kits
- Accessories & service parts
- KRJR K Body® REVO™ JR
- UK UniKlamp® case clamp



## 11-14 Woodworking clamps and cast jaw bar clamps

- LMU Light duty, step over
- LM Light duty, zinc die cast
- TG & TGJ Light duty series
- TG Medium duty series
- TGK Heavy duty series
- TC TC series with flat rail
- CDS Deep reach with flat rail
- Service parts
- BTB30A TGJ TG kit (30 piece with display)
- BGP General clamp kit (10 piece)
- BTB30 TGJ TG kit (30 piece)



## 15-16 Specialty all-steel clamps

- J18 J Series step-over light duty
- 2400J J Series step-over regular duty
- 4800J J Series step-over heavy duty
- DT 2400 Regular duty deep throat version
- CL Claw clamp
- SG30VAD KombiKlamp®
- RSC OMEGA bend clamps



## 17-18 Double force all-steel variable clamps

- SLV, GSV Variable high-performance set
- Rails and sliding arms
- Service parts



## 19 Rapid-Action lever clamps

- LC, 1800L Lever clamps
- GSH classiX®



## 20 Light duty lever clamp

- KLI KliKlamp®



## 21-22 Clamping angles and miters

- WSM Angle clamp
- WVS Multi-angle vise clamp
- WS Angle clamps
- WS Corner clamp



## 23 Heavy duty steel bar clamps

- IBEAM Heavy duty IBeam
- Service parts
- TB T-bar sash clamps
- TB clamps service parts



## 24 Pipe clamps

- PC-2 Pipe clamp, traditional style
- BPC Pipe clamp, H style
- PC-DR Deep reach pipe clamp, traditional style
- Service parts



## 25-26 Spring clamps

- XV VarioClippix® variable spring clamps
- XV VarioClippix® variable spring clamp, double jaw
- XCL Clippix® needle nose plastic spring clamps
- XC Clippix® premium plastic spring clamps
- XCRG Clippix® ratcheting spring clamps
- XC Clippix® plastic spring clamp set
- XM Steel spring clamps



## 27-28 One-handed & clutch style clamps

- EHK EHK Trigger Clamp
- EZS & EZ One-handed clamps
- DUO DuoKlamp® one-handed clamp
- PG PowerGrip one-handed clamp
- Service parts



## 29-30 Auto-Adjust toggle clamps

- STC-VH Vertical toggle clamp
- STC-IHH, STC-IHA Inline toggle clamps
- STC-HH, STC-HV, STC-HA Horizontal toggle clamp
- Service parts



## 31 Workbench adapter

- STC-SET-T20 Accessory for multifunction (MFT) table



## 32-34 Hold down products and specialty clamps

- Model L RiteHite long reach
- Model S RiteHite standard reach
- BSN, HD, BSG Hold down table clamps
- MCL Claw machine clamp
- FC Jig & fixture clamp



## 35 Machine table BAS clamps

- BAS-C Compact clamp with open mounting hole
- BAS-CB Compact clamp with closed mounting hole
- BASO Base unit



## 36 Workbench adapter

- TWAW Accessory for workbenches



## 37-40 Welding table clamps

- TWV Variable throat depth
- TW Fixed throat depth
- TWM28 With special pressure plate
- TW28GRS Welding table clamp
- TWVAD Welding table clamp accessories
- TWA-STC Welding table clamp adapter
- TWX Welding table clamp extension
- TW28AV Welding table clamp tilting adapter
- TW28HO Welding table clamp attachment
- Service parts, MorPads



## 41-42 Clutch style bar clamps

- GSCC Clutch style
- GSCC4PK Clutch style clamshell pack
- DHBC Clutch style with double jaw





## 43 Strap clamps

- VAS Variable angle
- VAS400 Variable angle
- VAC Vario corner clips



<b>44-46</b>	<b>C-clamps</b>	
HS series	Heavy service, fully closing	
100 series	Heavy duty	
CDF	Regular duty	
CDFCHV	Regular duty, copper spindle, Hi-Vis	
540 series	Ductile alloy	
CM	Light duty	
QRCC	Quick release	
DHCC	Double head	

<b>47</b>	<b>Grip pliers</b>	
SG	SuperGrips® with profiled rail	
SG-PC	SuperGrips® pipe clamp	
SG-DR	SuperGrips® deep reach clamp	

<b>48</b>	<b>Edge clamps</b>	
EKT	Edge clamp, one hand	
KF	Edge clamp	
B-EC3	3-way edge clamp, light duty	
KT5	Spindle clamps	
Service parts		

<b>49</b>	<b>Seaming tools</b>	
PS	Extra large solid surface seaming tool	
PS	Solid surface seaming tool	

<b>50</b>	<b>Cabinetry clamp, face frames</b>	
BES8511		

<b>51</b>	<b>Track / table clamps</b>	
GTR	Wood handle	
GTRH	Lever handle	

<b>52</b>	<b>Floor tools</b>	
AV2	Flooring spacer	
PVA	Flooring clamps	
SVH	Flooring strap clamps	

<b>53</b>	<b>Other clamps</b>	
S-10	Portable mini-vise	
TK	Table mount clamp	
HS	Wood handscrew clamps	
KF	Panel carrier	
BTB	Accessory bag	
TP	Zippered pouch	

<b>54-56</b>	<b>Vises</b>	
BV-DF	Industrial bench vise	
BV-MPV5	Multi-purpose vise	
BV-HD	Heavy duty workshop vises	
BV-HW45	Light duty workshop vise	
BV-DP40	Drill press vise	
BV-CD30	Clamp-on vise	
BV-VB	Vacuum base vise	
BV-NVJ	Multi-purpose vise jaws	
BV-WV65	Wood vise	
Service parts		

<b>57-61</b>	<b>BESSEY® bearing heaters</b>	
PV, PVH	Portable, digital temperature control	
SVH	Fast Action, portable, digital temperature control	
SV	Portable, medium duty, digital temperature control	
MP	Magnetic temperature probe	
SVH, PV, PVH	Cross bars for bearing heaters	
SC, BC, BCS	Induction bearing heaters	
RB	Raising blocks	
HH11B	Pyrometer/Thermometer	
SC, BC, BCS	Cross bars for bearing heaters	
GCS	Cone style bearing heaters – non-induction	
BRG33	Bearing mounting unit	

<b>62-63</b>	<b>Industrial magnets</b>	
WMS-1,3,5	Magnetic squares	
WMS-4	Double magnetic square	
WMS-6	Multi-angle square	
WMS-7	Arrowhead magnetic square	
CMS	“Chunky” magnetic square	
BDMS	“Big Daddy” magnetic square	
MGC	Magnetic ground clamps	
MPU	Mag Pick-Up	
MS	MagStick	
MW	MagWand	
MSP	MagSweep	

<b>64-71</b>	<b>Snips &amp; knives</b>	
D39ASS	Multi-use aviation snip	
D15A	Multi-use aviation snip, compact	
D16	Aviation snips	
D29ASS-2	Offset snips, optimized	
D27AH-BE	Offset, extra hard, high tolerance	
D29SS-2	Special hard cutting snips	
D22A	Long-nose, multi-purpose	
D123-SB	Safety strap cutter	
D47, D48	MultiSnip - Straight	
D48A	MultiSnip - Offset	
D49	Cable cutter	
D50	Combinox	
D51A	MultiSnip master	
D-BKPH	Folding utility knife - ABS comfort grip	
DBKPH	Folding utility knife set - ABS comfort grip	
D-BKWH	Folding utility knife - Wood handle	
D-BKAH	Folding utility knife - Aluminum handle	
DBST	Multi-function tool	

<b>72</b>	<b>Industrial fluids &amp; compounds</b>	
LM	Lab-metal®	
HT	Hi-Temp Lab-metal®	
LS	Lab-solvent	
OPT	Relton OPTION 1® cutting fluid	
A9	Relton A-9® aluminum cutting fluid	
RT	Relton Rapid Tap® cutting fluid	

<b>72</b>	<b>Torque multipliers</b>	
JM	Torque multipliers	

<b>73-76</b>	<b>Index</b>	<b>A-Z</b>
--------------	--------------	------------

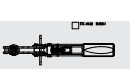
<b>77-78</b>	<b>STC charts</b>	
--------------	-------------------	---

<b>79-82</b>	<b>Resources</b>	
--------------	------------------	---

Social media, Connect with BESSEY®  
 Customer service, best practices  
 Cautions & warnings, terms & conditions - distributor  
 Warranty policy, return procedures, Calprop statement  
 History of James Morton  
 Downloads  
 Notes



# Premium all-steel bar clamps



## Premium all-steel bar clamps

Premium all-steel bar clamps from BESSEY® represent the peak of the all-steel bar clamp category. Made in Germany, this series delivers uncompromising quality, patented features, durability and real-world productivity to make it a must-have tool in today's modern workshop.

### 1 Patented rail profile

For greater stability, enhanced clamping force and 20% more clamping force per spindle turn for quicker set-up times (660, 1200, 1800 and 2400 series).

### 2 BESSEY® MorPad

Designed to reduce friction at the point of contact, increasing and optimizing clamping force. Using BESSEY product with the MorPad extends tool life and, at full clamping potential.

### 3 Hardened spindle

Heat-treated, high carbon Acme threaded spindle manufactured for high load capacity, durability and spatter resistance.

### 4 Size engineered T-Bar

Ergonomic, high-strength sliding pin T-Bar. BESSEY Grip comes standard with 1800-S/2400S.

### 5 Drop forged sliding arm

U-shaped sliding arm transfers clamping force evenly across the surface of the forged piece improving power transmission and stability for a longer lasting tool.



### A Light duty clamps, 660-S and 1200-S series

The light duty all-steel clamps come with BESSEY's patented rail profile, force optimized drop forged arm and a standard replaceable pad. Made in Germany.

	Clamping Capacity	Throat Depth	Clamping Force	Approx. Weight
<b>660-S8</b>	8"	4"	726 lbs	2.05 lbs
<b>660-S12</b>	12"	4"	726 lbs	2.35 lbs
<b>660-S18</b>	18"	4"	726 lbs	2.90 lbs
<b>1200-S8</b>	8"	5 1/2"	1320 lbs	3.75 lbs
<b>1200-S12</b>	12"	5 1/2"	1320 lbs	4.20 lbs
<b>1200-S18</b>	18"	4 3/4"	1320 lbs	4.85 lbs
<b>1200-S24</b>	24"	4 3/4"	1320 lbs	5.30 lbs



### B Medium duty clamps, 1800-S series

The medium duty all-steel clamps come with BESSEY's grip handle, patented rail profile, force optimized drop forged arm and the MorPad. Made in Germany.

	Clamping Capacity	Throat Depth	Clamping Force	Approx. Weight
<b>1800-S8</b>	8"	4 3/4"	1980 lbs	4.00 lbs
<b>1800-S12</b>	12"	4 3/4"	1980 lbs	4.40 lbs
<b>1800-S18</b>	18"	4 3/4"	1980 lbs	5.30 lbs
<b>1800-S24</b>	24"	4 3/4"	1980 lbs	6.30 lbs



### C Regular duty clamps, 2400S series

BESSEY®'s regular duty all-steel clamps are best sellers. They come with BESSEY's grip handle, patented rail profile, force optimized drop forged arm and the MorPad. Made in Germany.

	Clamping Capacity	Throat Depth	Clamping Force	Approx. Weight
2400S-8	8"	5 1/2"	2800 lbs	6.45 lbs
2400S-12	12"	5 1/2"	2800 lbs	6.80 lbs
2400S-16	16"	5 1/2"	2800 lbs	7.40 lbs
2400S-20	20"	5 1/2"	2800 lbs	8.10 lbs
2400S-24	24"	5 1/2"	2800 lbs	8.80 lbs
2400S-36	36"	5 1/2"	2800 lbs	11.40 lbs
2400S-48	48"	5 1/2"	2800 lbs	12.30 lbs
2400S-60	60"	5 1/2"	2800 lbs	14.25 lbs



### D Heavy duty clamps, 4800S series

The heavy duty all-steel clamps are perennial favorites for their strength and durability. They come with BESSEY's grip handle, standard rail profile and the MorPad. Made in Germany.

	Clamping Capacity	Throat Depth	Clamping Force	Approx. Weight
4800S-12	12"	7"	4880 lbs	12.40 lbs
4800S-18	18"	7"	4880 lbs	14.70 lbs
4800S-24	24"	7"	4880 lbs	16.20 lbs
4800S-36	36"	7"	4880 lbs	20.75 lbs
4800S-48	48"	7"	4880 lbs	23.85 lbs
4800S-60	60"	7"	4880 lbs	26.90 lbs



### E Extra heavy duty clamps, 7200S series

'Robust' would hardly begin to describe these highly capable (and unique to BESSEY®) clamps which are designed for extra heavy industrial applications. The spindle has a 36 mm hexagonal head to assist in tightening (torque of 100 Nm or less). Comes with: Standard rail profile, specially designed MorPad.

	Clamping Capacity	Throat Depth	Clamping Force	Approx. Weight
7200S-12	12"	8"	7770 lbs	23.10 lbs
7200S-18	18"	8"	7770 lbs	26.85 lbs
7200S-36	36"	8"	7770 lbs	36.45 lbs



### F Extra high pressure clamps, 8500 series

This clamp has a narrower throat depth which enables a much higher clamping force than a comparably sized clamp with a larger throat depth. Comes with: Standard rail profile, MorPad.

	Clamping Capacity	Throat Depth	Clamping Force	Approx. Weight
8500HPC-14	14"	4"	8500 lbs	11.65 lbs



# Traditional all-steel bar clamps

## Traditional all-steel bar clamps

Made in Germany, the traditional series of clamps offers a unique value proposition to the professional. Its mid-range pricing offers the highest quality and value but, does not come with all the enhanced features of the premium product offering.



### 1 Traditional rail profile

The rail profile offers great stability, reliable clamping force and consistent clamping force per spindle turn.

### 2 Standard pads and heavy duty pads

The standard swivel pads and heavy duty pads are proven contact surfaces for the traditional clamps.

### 3 Hardened spindle

The heat-treated, high carbon Acme threaded spindle offers high load capacity, durability and spatter resistance.

### 4 Size engineered T-Bar

The high-strength sliding pin T-Bar is sized according to the clamp's capability.



### A Light duty, MMS series

Sometimes the right tool has nothing to do with size. The MMS clamps are easy to use, quick to adjust and offer great value. At 400 lbs of clamping force they offer a high level of performance. Comes with standard rail profile, standard crimped on swivel pads.



	Clamping Capacity	Throat Depth	Clamping Force	Approx. Weight
<b>MMS-4</b>	4"	2 1/4"	400 lbs	0.60 lbs
<b>MMS-8</b>	8"	2 1/4"	400 lbs	0.75 lbs
<b>MMS-12</b>	12"	2 1/4"	400 lbs	0.85 lbs



### B Medium duty all-steel bar clamp, SGL series

The standard profile rail and heavy duty pad of this series make it one of the best all-steel bar clamps in the world. Produced in Germany from cold-drawn German steel – like the rest of the Premium and Traditional series. Includes standard rail profile, heavy duty pad.



	Clamping Capacity	Throat Depth	Clamping Force	Approx. Weight
<b>SGL-8</b>	8"	4 3/4"	1800 lbs	4.00 lbs
<b>SGL-12</b>	12"	4 3/4"	1800 lbs	4.75 lbs
<b>SGL-18</b>	18"	4 3/4"	1800 lbs	5.85 lbs
<b>SGL-24</b>	24"	4 3/4"	1800 lbs	6.35 lbs

### C Regular duty all-steel bar clamp, SQ series

The standard profiled rail and heavy duty pad make this series one of the best all-steel bar clamps in the world. Produced in Germany from cold-drawn German steel. Includes standard rail profile, heavy duty pad.

	Clamping Capacity	Throat Depth	Clamping Force	Approx. Weight
<b>SQ-4*</b>	6"	4 3/4"	1330 lbs	2.35 lbs
<b>SQ-8</b>	8"	5 1/2"	2660 lbs	6.00 lbs
<b>SQ-12</b>	12"	5 1/2"	2660 lbs	6.70 lbs
<b>SQ-16</b>	16"	5 1/2"	2660 lbs	7.40 lbs
<b>SQ-20</b>	20"	5 1/2"	2660 lbs	8.10 lbs
<b>SQ-24</b>	24"	5 1/2"	2660 lbs	8.75 lbs

\*SQ-4 has a standard pad.

### D Heavy duty all-steel bar clamp, STB series

German produced classic profiled rails, hardened spindles (with 19 mm hex head) and sizes up to 36" makes this a real-world solution for heavy duty applications on a tighter budget. Comes with standard rail profile, crimped on swivel pad.

	Clamping Capacity	Throat Depth	Clamping Force	Approx. Weight
<b>STB-12</b>	12"	7"	4880 lbs	12.20 lbs
<b>STB-18</b>	18"	7"	4880 lbs	14.70 lbs
<b>STB-24</b>	24"	7"	4880 lbs	16.00 lbs
<b>STB-36</b>	36"	7"	4880 lbs	20.60 lbs

### E classiX® light duty, GS series

A range of clamp sizes and performance characteristics with a field replaceable contact standard pad (see page 5).

	Clamping Capacity	Throat Depth	Clamping Force	Approx. Weight
<b>GS12-8K</b>	4"	3 1/8"	550 lbs	1.00 lbs
<b>GS16K</b>	6"	3 1/8"	550 lbs	1.05 lbs
<b>GS20K</b>	8"	4"	880 lbs	1.90 lbs
<b>GS16-12K</b>	6"	4 3/4"	1000 lbs	2.35 lbs
<b>GS25K</b>	10"	4 3/4"	1000 lbs	2.65 lbs
<b>GS30K</b>	12"	5 1/2"	1200 lbs	3.95 lbs
<b>GS60K</b>	24"	4 3/4"	1200 lbs	5.25 lbs

### F classiX® - medium duty, GSL series

Designed for heavier applications, the classiX® line with heavy duty pads comes with classic rail profiles and a range of clamp openings that will meet most day to day needs.

	Clamping Capacity	Throat Depth	Clamping Force	Approx. Weight
<b>GSL30</b>	12"	4 3/4"	1880 lbs	5.00 lbs
<b>GSL60</b>	24"	4 3/4"	1880 lbs	6.30 lbs

### G classiX® - regular duty, GSM series

With even more clamping force, heavy duty pad and classic rail profile, plus a range of clamp openings that will meet most day to day needs.

	Clamping Capacity	Throat Depth	Clamping Force	Approx. Weight
<b>GSM20</b>	7 1/2"	4 3/4"	2660 lbs	5.20 lbs
<b>GSM25</b>	9"	5 1/2"	2660 lbs	5.75 lbs
<b>GSM30</b>	12"	5 1/2"	2660 lbs	6.35 lbs
<b>GSM40</b>	16"	5 1/2"	2660 lbs	6.70 lbs
<b>GSM50</b>	20"	5 1/2"	2660 lbs	7.40 lbs
<b>GSM60</b>	24"	5 1/2"	2660 lbs	8.10 lbs





# Spare parts for all-steel clamps

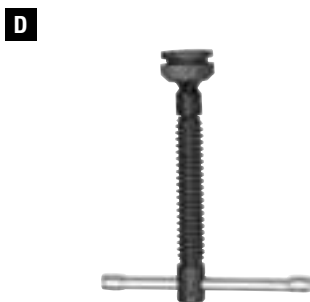

## A MorPad Heavy duty pad

- 3100736** 12/18/24/4800, SGL, SQ, STB, GSL and GSM
- 3101192** Rough face - 12/18/24/4800, SGL, SQ, GSL and GSM
- 3101193** V Groove - 12/18/24/4800, SGL, SQ, GSL and GSM
- 3100737** 7200S

## B Standard pad

- 3101339** MMS (4 pc) (must be crimped on)
- 3101180** GS16K, GS12-8K (4 pc)
- 3101183** RSC-8, 660S, J18, GS16-12K, GS25K, GS20K, SQ-4 (4 pc)
- 3101188** 1200, RSC-12, 18 & 24, SQ, SG30VAD, GS30K (4 pc)

## C Grip handles

- 3006727** RSC-8, 660S, SQ-4
- 3006786** RSC-12, 18 & 24, 1200, 1800-S, 2400S, SQ, SGL, SG30VAD

## D Complete spindle assembly

- 3100398** 1200/1800, SGL screw spindle (.700" Dia.)
- 3100399** 2400, SQ, GSL, GSM spindle (.775" Dia.)
- 3100400** 4800/8500, STB spindle (.850" Dia.)
- 3100401** 7200 Spindle (.925 Dia.)

## E Spindle/handle assembly

- 3101795** GS20K, RSC-8
- 3101796** GS16-12K, GS25K, 660S, J18, SQ-4
- 3101797** GS30K, 1200S, RSC-12/18/24, GS60K, SGL

## F Sliding arm assembly

	Compatible with	Standard Pad	Throat Depth
<b>3101441</b>	660 Series	*	4"
<b>3101447</b>	1200 Series (5 1/2" throat)	*	5 1/2"
<b>3101450</b>	1200 Series (4 3/4" throat)	*	4 3/4"
<b>3101521</b>	1800S Series		4 3/4"
<b>3101407</b>	2400S Series		5 1/2"
<b>3101330</b>	SQ Series, GSM		5 1/2"
<b>3101331</b>	DT 2400 Series		8"
<b>3101332</b>	4800S Series		7"
<b>3101798</b>	7200S Series		8"
<b>3101882</b>	8500HPC Series		4"
<b>3101800</b>	GS20K, RSC-8	*	4"
<b>3101801</b>	SQ-4, J18, GS25K, GS16-12K	*	4 3/4"
<b>3101802</b>	1200S-12, GS30K, RSC-12	*	5 1/2"
<b>3101803</b>	1200S-8, GS60K, RSC-18/24	*	4 3/4"
<b>3101804</b>	SGL, GSL	*	4 3/4"

\*Includes standard pad.

## G Variable angle device

- VAD** Fits up to 2400 series, SQ

## H Wedges

- 3101788** For 7200S
- 3005122** For 8500HPC
- 3100579** Nut and lock ring, 7200S



# GearKlamp® bar clamps

GearKlamp® 2018 Tool Awards

## Works "BIG" in a small space

A unique twist on clamping. Find out how this product can simplify tricky clamping applications.

### 1 Intelligent design

The first clamp of it's kind easily reaches places that were once difficult or impossible to access. Patented mechanism separates spindle from handle for greater clearance. The unique mechanism allows the handle to be offset from the point of contact. This creates the possibility of reaching "into" confined spaces to achieve clamping solutions. Fully enclosed mechanism is protected from dust and debris.

### 2 Easy to use

Quick adjust button for big movements on the bar. Quick turn handle for comfortable, strong clamping.

### 3 Ideal for clamping operations...

In a cramped location. Up against another object. Reaching into or across somewhere to clamp.

### 4 BESSEY Strength

Tempered steel, profiled rail for durability. Secure clamping force up to 450 lbs. Durable construction using fiberglass reinforced polyamide housing.

### 5 Protective caps over grooved grip

Removeable pad reveals a grooved section to clamp oddly shaped objects. Protective caps are provided to prevent marring of wood.



## A GearKlamp® bar clamps, GK series

The first of it's kind provides a unique clamping solution for difficult set-ups in tight spaces. Quick-shift button on the arm for broad movements of the operating jaw. Once the operating jaw is in position the "around-the-rail" handle is twisted clockwise to tighten the clamp. To loosen the clamp, twist the clamp handle counterclockwise.

	Clamping Capacity	Throat Depth	Clamping Force	Approx. Weight
<b>GK15</b>	6"	2 3/8"	450 lbs.	1.36 lbs.
<b>GK30</b>	12"	2 3/8"	450 lbs.	1.60 lbs.
<b>GK45</b>	18"	2 3/8"	450 lbs.	1.85 lbs.
<b>GK60</b>	24"	2 3/8"	450 lbs.	2.09 lbs.





BESSEY® Parallel bar clamp systems

# Powerful parallel clamping at its best

## K Body® REVO™ **REVOLUTION**

The best parallel clamp in the world with the features you want!



### **A** K Body® REVOLUTION, KRE

The BESSEY fixed jaw parallel clamps are class-leading examples of BESSEY's commitment to continuous improvement. Powerful 90 degree, no-slip clamping rated at a nominal 1700 lbs of everyday clamping force. This clamp can be quickly and easily set up for clamping or spreading without the use of secondary tools. Ideal for precision cabinetry, heavy duty laminations and robust general clamping. Ships as a 2-pack.

**MORE than a clamp...** part of a comprehensive clamping concept. REVO and Vario REVO are made even more versatile with innovative accessories (see page 9).

	Clamping Capacity	Throat Depth	Clamping Force	Approx. Weight	Spreading Capacity
KRE3512	12"	3 3/4"	1700 lbs	4.76 lbs	10 1/2" – 15 5/16"
KRE3518	18"	3 3/4"	1700 lbs	5.40 lbs	10 1/2" – 21 1/2"
KRE3524	24"	3 3/4"	1700 lbs	6.06 lbs	10 1/2" – 28 3/4"
KRE3531	31"	3 3/4"	1700 lbs	6.86 lbs	10 1/2" – 36 1/2"
KRE3540	40"	3 3/4"	1700 lbs	7.61 lbs	10 1/2" – 44 1/2"
KRE3550	50"	3 3/4"	1700 lbs	8.51 lbs	10 1/2" – 52 1/2"
KRE3560	60"	3 3/4"	1700 lbs	9.46 lbs	10 1/2" – 63 3/8"
KRE3582	82"	3 3/4"	1700 lbs	11.66 lbs	10 1/2" – 81 7/8"
KRE3598	98"	3 3/4"	1700 lbs	13.21 lbs	10 1/2" – 101 1/2"



### Well thought out

- Ergonomically formed 2-component handle with steel socket for applying force with a hex key or driver when desired (max. torque 17 Nm).



### Powerful with simple set up and operation

- Secure clamping force up to 1700 lbs.
- Operating jaw stays where you put it for easy set up. Position where you like and apply clamping force.



### Precise and gentle

- Workpieces with sensitive surfaces can be clamped and spread, parallel to each other.
- Workpiece supports also prevent the workpiece from coming into contact with the rail.



### Cold drawn steel rail bar

- Produced and tested at BESSEY's own mills with consistently high quality and the utmost precision in cutting-edge facilities.



### Large clamping surfaces

- Clamping surfaces are perpendicular to the rail.
- Three removable pressure caps that are repellent to glue, and resistant to paint and grease solvents.
- Large surface areas distribute high clamping force evenly.

## The best parallel clamp in the world just got better!

The BESSEY parallel clamp has been a trusted fixture in many shops for decades because of its reliability and quality. Each successive generation of K Body builds upon the previous generation's strengths and the REVolution is no different !!

With secure clamping up to 1700 lbs, the new K Body REVolution (KRE) is designed to clamp at 90 degrees to the rail with large clamping surfaces. The ergonomic two part handle includes a steel socket that allows one to apply clamping force using a hex key. While this helpful feature was designed for ease of clamping, it does allow one to provide more clamping force and is particularly helpful for those with wrist strength issues.

The operating jaw has undergone some evolutionary changes as well. Position it where you want and start clamping. The easy set up allows one to position the operating jaw where you want and, it will stay put during set up. Three removable pressure caps allow for easy cleaning and, the two work piece supports prevent the work piece from contacting the rail. A removable end clip allows tool-free set-up for spreading.



### Vario K Body

- Vario K Body offers a unique moveable "fixed" jaw. This allows more effective balance of workpieces during set-up, and enables custom clamping set up.

## **B** Vario K Body® REVolution, KREV Clamping System

The BESSEY Vario version has all the same great features as the K Body REVolution ...PLUS...the "fixed" jaw can be moved along the bar. This subtle difference allows for a whole range of game-changing applications. Make the clamp longer by connecting them with a KBX20 accessory, add an operating jaw (KRE-J2K) or fixed jaw accessory (KRE-VO) and tackle multiple clamping jobs at the same time. You can add angle adaptors (KR-AS) for tapered parts or, attach the clamping system to a table top for more stability using the TK-6. Imagine the possibilities!

**MORE than a clamp...** part of a comprehensive clamping concept. REVO and Vario REVO are made even more versatile with these innovative accessories (see page 9).



	Clamping Capacity	Throat Depth	Clamping Force	Approx. Weight	Spreading Capacity
<b>KREV40</b>	40"	3 ¾"	1700 lbs	8.48 lbs	10 ½" – 44"
<b>KREV60</b>	60"	3 ¾"	1700 lbs	9.35 lbs	10 ½" – 63"
<b>KREV78</b>	78"	3 ¾"	1700 lbs	11.66 lbs	10 ½" – 81"
<b>KREV98</b>	98"	3 ¾"	1700 lbs	13.86 lbs	10 ½" – 101"



# Powerful parallel clamping at its best

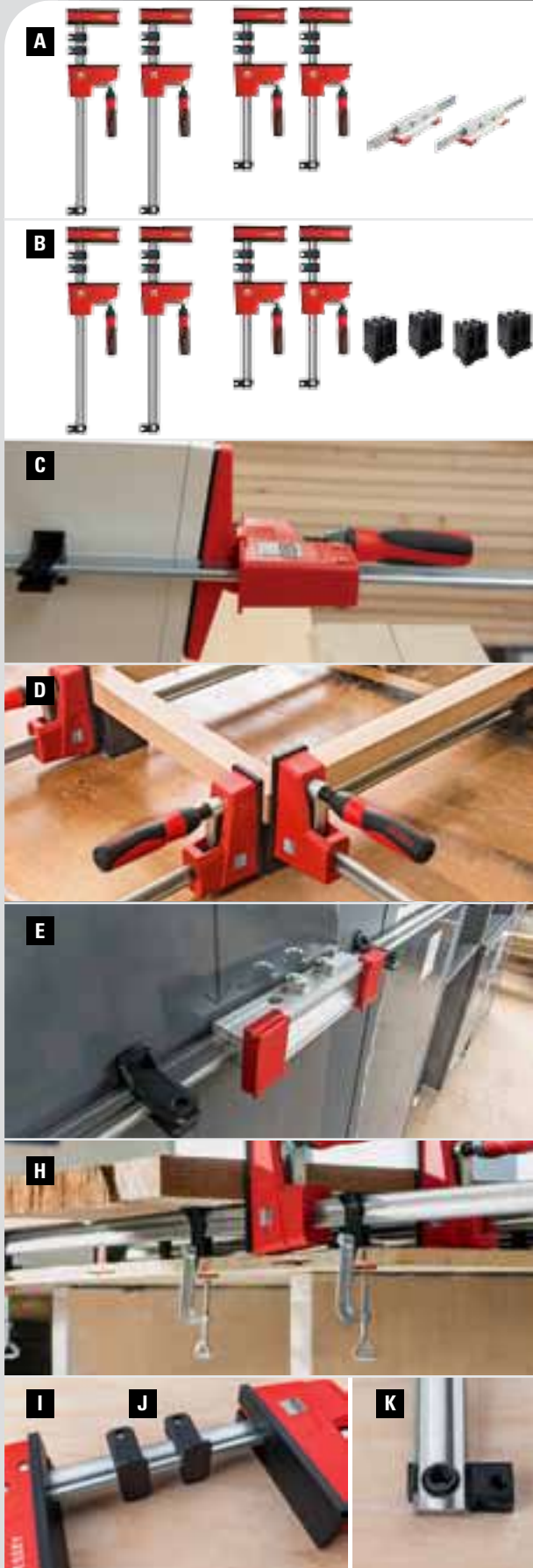

**MORE than a clamp...** part of a comprehensive clamping concept. REVO and Vario REVO are made even more versatile with these innovative accessories.

**A K Body® REVO™ extender kits**

24"/40" set, or 24"/50" set.

	Includes	Approx. Weight
<b>KREX2440</b>	2 x KRE3524 (24" K Body REVO) 2 x KRE3540 (40" K Body REVO) 2 x KBX20 (K Body extenders)	30.00 lbs
<b>KREX2450</b>	2 x KRE3524 (24" K Body REVO) 2 x KRE3550 (50" K Body REVO) 2 x KBX20 (K Body extenders)	32.00 lbs

**B K Body® REVO™ framing kits**

24"/40" set, or 24"/50" set.

	Includes	Approx. Weight
<b>KREK2440</b>	2 x KRE3524 (24" K Body REVO) 2 x KRE3540 (40" K Body REVO) 1 set KP blocks (4 blocks/set)	29.00 lbs
<b>KREK2450</b>	2 x KRE3524 (24" K Body REVO) 2 x KRE3550 (50" K Body REVO) 1 set KP blocks (4 blocks/set)	31.00 lbs

**C K Body tilting adapter KR-AS**

Soft faced tilting pads attach to the clamping jaws. Adjustable within a tilting range of -15 or +15. Ideal for glue-ups that are not 90 degrees. Soft, gripping surfaces, bevelled surface. 2/set.

**D K Body framing set KP**

Set of four 90 degrees clamping blocks for framing work. The clamping pressure can be set separately for each corner. Ideal for pictures, drawers and doors. 4/set.

**E K Body extender KBX20**

Two becomes one: with the easy-to-use extension made of sturdy aluminum the clamping width can be increased by joining two clamps. 2/set. Suitable for all K Body REVO versions.

**F K Body variable jaw KRE-VO**

Suitable for all BESSEY K Body REVO parallel clamps KREV, KRE, KRV and KR. Add an extra one for multiple set-ups.

**G K Body operating jaw, KRE-J2K**

Suitable for all BESSEY K Body REVO parallel clamps KREV, KRE, KRV and KR. Add an extra operating jaw for multiple glue ups.

**H Table clamp TK-6**

For KR, KRV, KRE and KREV. Securely attaches the clamp to the work surface. For creating a more "fixed" clamping system. 2/set.

**I K Body jaw pads, KR-JP**

For KR, KRV, KRE and KREV. Replacement jaw pads, 2 jaw pads/set.

**J K Body rail protection pieces, KRE-RPP**

For KR, KRV, KRE and KREV. Replacement rail protection pieces, 2/set.

**K K Body end clip, KRE-EC**

For KR, KRV, KRE and KREV. Replacement rail end, 1/set.



# Powerful parallel clamping at its best



## Powerful parallel clamping at its best

BESSEY® continues innovating to meet the needs of the serious woodworker. For production settings or home shops, there is always a need for a powerful, parallel, BESSEY® product.

**1 Parallel clamping surface with jaw protection pads**

Three large removable (for cleaning or replacement) pressure caps are resistant to glue, paint and solvents.

**2 Wood handle**

Ergonomically shaped.

**3 Rail protection pieces**

Pieces work to isolate and elevate the workpiece from the rail.

**4 Removable end-clip**

End-clip ensures clamp sits parallel to work surface.  
Removable to reverse sliding arm for use as spreader.



**A K Body® REVO™JR parallel clamps**

The new K Body® REVO™JR is a mid-sized version of what makes the full-sized REVO parallel clamp so great. Parallel jaws, good power and a lighter relative weight, combined with a very competitive price point.

	Clamping Capacity	Throat Depth	Clamping Force	Approx. Weight
<b>KRJR-12</b>	12"	3 1/4"	900 lbs	2.86 lbs
<b>KRJR-18</b>	18"	3 1/4"	900 lbs	3.16 lbs
<b>KRJR-24</b>	24"	3 1/4"	900 lbs	3.40 lbs
<b>KRJR-36</b>	36"	3 1/4"	900 lbs	4.21 lbs
<b>KRJR-50</b>	50"	3 1/4"	900 lbs	4.91 lbs



**B UniKlump® case clamp**

This light duty universal case clamp is an ideal tool for many jobs around the shop. For clamping or spreading, the lower clamping pressures spread over a wider surface are gentler on delicate work surfaces and, the light weight means less fatigue during glue-ups. Removable end clip for conversion to a spreader.

	Clamping Capacity	Throat Depth	Clamping Force	Approx. Weight
<b>UK3.006</b>	6"	3 1/8"	330 lbs	1.36 lbs
<b>UK3.012</b>	12"	3 1/8"	330 lbs	1.59 lbs
<b>UK3.024</b>	24"	3 1/8"	330 lbs	2.04 lbs



# BESSEY® quality, durability and strength



## Malleable cast bar clamps

The original BESSEY® malleable cast iron bar clamp is available in two designs. Either with the tried-and-true wooden handle, or the modern BESSEY® 2K handle. The high quality 2K composite handle with comfort insert allows you to complete tasks more effectively and with less hand fatigue.

- 1 Integrated anti-slip system**  
Maximum safety is available with the integrated anti-slip system. A set screw is molded into the sliding arm and interlocks with the serration on the rail.
- 2 Reinforced jaw and sliding arm**  
Corrugated malleable cast iron fixed jaw and sliding arm generate powerful, rigid clamping.
- 3 High quality profiled rail**  
The BESSEY® profiled rail from our own German steel plant has been optimized for clamps. The profile acts against torsional forces.
- 4 BESSEY® smooth running spindle**  
Smooth running spindle with Acme thread allows for more clamping with less effort. Replaceable pressure plates.
- 5 BESSEY® comfort handle**  
The TG series offers both the tried-and-true wooden handle or 2K composite handle with comfort insert.



## A Light duty, zinc die cast bar clamp, LM series

Small, light weight and made of quality durable material.

	Clamping Capacity	Throat Depth	Clamping Force	Approx. Weight
<b>Step-over U shape</b> clamps over small obstructions and apply the clamping force where you need it. Comes with two plastic pressure caps				
<b>LMU2.004</b>	4"	2"	330 lbs	0.50 lbs
<b>LMU2.006</b>	6"	2"	330 lbs	0.60 lbs
<b>LMU2.008</b>	8"	2"	330 lbs	0.65 lbs
<b>Zinc die cast</b> clamping arms are powder coated to prevent chemical corrosion. Comes with a plastic cap on pressure pad				
<b>LM2.004</b>	4"	2"	330 lbs	0.55 lbs
<b>LM2.006</b>	6"	2"	330 lbs	0.60 lbs
<b>LM2.008</b>	8"	2"	330 lbs	0.70 lbs
<b>LM2.012</b>	12"	2"	330 lbs	0.80 lbs



## B Light duty TG & TGJ, with 2K handle

The rail's hourglass profile contributes to the TG serie's ability to resist flex. Even the light duty version is a tough tool built with the quality you expect from BESSEY®. Includes ergonomic 2K handle.

	Clamping Capacity	Throat Depth	Clamping Force	Approx. Weight
<b>TGJ2.506+2K</b>	6"	2 1/2"	600 lbs	1.45 lbs
<b>TGJ2.512+2K</b>	12"	2 1/2"	600 lbs	1.80 lbs
<b>TGJ2.518+2K</b>	18"	2 1/2"	600 lbs	2.15 lbs
<b>TGJ2.524+2K</b>	24"	2 1/2"	600 lbs	2.50 lbs
<b>TGJ2.530+2K</b>	30"	2 1/2"	600 lbs	2.90 lbs
<b>TGJ2.536+2K</b>	36"	2 1/2"	600 lbs	3.25 lbs
<b>TG4.008+2K</b>	8"	4"	880 lbs	2.35 lbs
<b>TG4.012+2K</b>	12"	4"	880 lbs	2.62 lbs
<b>TG4.016+2K</b>	16"	4"	880 lbs	2.90 lbs
<b>TG4.024+2K</b>	24"	4"	880 lbs	3.48 lbs





**C Light duty TG & TGJ, with wood handle**

Hourglass rail profile resists flex. A tough tool built with the quality you expect from BESSEY®. Includes tried-and-true wooden handle.

	Clamping Capacity	Throat Depth	Clamping Force	Approx. Weight
TGJ2.506	6"	2 ½"	600 lbs	1.45 lbs
TGJ2.512	12"	2 ½"	600 lbs	1.80 lbs
TGJ2.518	18"	2 ½"	600 lbs	2.15 lbs
TGJ2.524	24"	2 ½"	600 lbs	2.50 lbs
TGJ2.530	30"	2 ½"	600 lbs	2.90 lbs
TGJ2.536	36"	2 ½"	600 lbs	3.25 lbs
TG4.008	8"	4"	880 lbs	2.35 lbs
TG4.012	12"	4"	880 lbs	2.62 lbs
TG4.016	16"	4"	880 lbs	2.90 lbs
TG4.024	24"	4"	880 lbs	3.48 lbs



**D Medium duty, TG, with 2K handle**

Load up on pressure, durability & versatility. Six serrated edges withstand a lot of pressure without slipping. Includes ergonomic 2K handle.

	Clamping Capacity	Throat Depth	Clamping Force	Approx. Weight
TG4.512+2K	12"	4 ½"	1000 lbs	3.55 lbs
TG4.518+2k	18"	4 ½"	1000 lbs	4.30 lbs
TG4.524+2k	24"	4 ½"	1000 lbs	4.65 lbs
TG4.530+2k	30"	4 ½"	1000 lbs	5.40 lbs
TG4.540+2k	40"	4 ½"	1000 lbs	6.23 lbs
TG5.512+2k	12"	5 ½"	1320 lbs	4.85 lbs
TG5.518+2k	18"	5 ½"	1320 lbs	5.80 lbs
TG5.524+2k	24"	5 ½"	1320 lbs	6.25 lbs
TG7.016+2k	16"	7"	1320 lbs	5.95 lbs
TG7.024+2k	24"	7"	1320 lbs	7.00 lbs
TG7.048+2k	48"	7"	1320 lbs	9.65 lbs



**E Medium duty TG with wood handle**

Features tried-and-true wooden handle.

	Clamping Capacity	Throat Depth	Clamping Force	Approx. Weight
TG4.512	12"	4 ½"	1000 lbs	3.55 lbs
TG4.524	24"	4 ½"	1000 lbs	4.65 lbs
TG4.540	40"	4 ½"	1000 lbs	6.23 lbs
TG5.512	12"	5 ½"	1320 lbs	4.85 lbs
TG5.524	24"	5 ½"	1320 lbs	6.25 lbs
TG7.016	16"	7"	1320 lbs	5.95 lbs
TG7.024	24"	7"	1320 lbs	7.00 lbs
TG7.048	48"	7"	1320 lbs	9.65 lbs



**F Heavy duty, TGK, with 2K handle**

More clamp force than most of us will ever need. High-end quality throughout. The 2K composite handle with comfort insert is standard.

	Clamping Capacity	Throat Depth	Clamping Force	Approx. Weight
TGK4.516+2K	16"	4 ½"	1540 lbs	5.80 lbs
TGK4.524+2K	24"	4 ½"	1540 lbs	6.75 lbs
TGK4.540+2K	40"	4 ½"	1540 lbs	9.05 lbs
TGK4.550+2K	50"	4 ½"	1540 lbs	10.65 lbs
TGK4.579+2K	79"	4 ½"	1540 lbs	14.65 lbs





# Extraordinary clamps



## G Malleable cast, TC, with flat rail

Flat rails are an economical alternative - stable solid flat rail with serration. German quality at an appealing price for industrial application. Comes with ergonomically shaped wood handle, standard pad, and plastic cap.

	Clamping Capacity	Throat Depth	Clamping Force	Approx. Weight
<b>TC4.008</b>	8"	4"	800 lbs	2.85 lbs
<b>TC4.512</b>	12"	4 1/2"	950 lbs	3.36 lbs
<b>TC5.512</b>	12"	5 1/2"	1200 lbs	4.85 lbs
<b>TC7.016</b>	16"	7"	1200 lbs	5.95 lbs



## H Deep reach, CDS, with flat rail

Need some extra reach? The CDS offers a throat depth of up to 20" when you need that extra deep reach. The large flat rail is serrated to prevent slipping. Comes with: Flat rail profile, standard pad, and plastic cap.

	Clamping Capacity	Throat Depth	Clamping Force	Approx. Weight
<b>CDS24-10 WP</b>	24"	10"	1550 lbs	11.05 lbs
<b>CDS24-12 WP</b>	24"	12"	1550 lbs	13.90 lbs
<b>CDS24-20 WP</b>	24"	20"	990 lbs	20.15 lbs



**I Plastic replacement caps**

Fits all TG, TC and CDS clamps

- 3101392 TGJ2.5 (10/set)
- 3101394 TG4.0 (10/set)
- 3101395 TG4.5 (10/set)
- 3101396 TGK, TG5.5, TG7.0, CDS (10/set)



**J Standard pad**

Fits all TG, TC and CDS clamps. Replacement jaw pads, 2 jaw pads/set.

- 3101180 TGJ2.5 (4 pc)
- 3101183 TG4.0, TG4.5 (4 pc)
- 3101188 TG5.5, TG7.0, TGK4.5, CDS (4 pc)



**K 2K Handle with pad**

Fits all TG, TC and CDS clamps. 2K replacement handle.

- 3101179 TGJ (1 pc)
- 3101182 TG4 (1 pc)
- 3101186 TG4.5 (1 pc)
- 3101187 TG5.5, TG7, TGK, CDS (1 pc)

**L TGJ kit BTB30A**

30 piece (with display) malleable cast clamps.

	Kit includes:	Approx. Weight
<b>BTB30A</b>	4 x TGJ2.506+2K (6")	82.00 lbs.
	6 x TGJ2.512+2K (12")	
	4 x TGJ2.518+2K (18")	
	8 x TGJ2.524+2K (24")	
	4 x TGJ2.530+2K (30")	
	4 x TGJ2.536+2K (36")	
	1 x A Frame display	

**L**



**M General multi-purpose clamp kit BGP**

10 piece malleable cast clamps.

	Kit includes:	Approx. Weight
<b>BGP</b>	2 x TGJ2.506 (6")	17.00 lbs.
	2 x TG4.008 (8")	
	2 x LM2.004 (4")	
	2 x PC34-2 (3/4")	
	2 x XM5 (2")	

**M**



**N TGJ TG kit BTB30**

30 piece malleable cast clamps.

	Kit includes:	Approx. Weight
<b>BTB30</b>	4 x TGJ2.506 (6")	72.00 lbs.
	6 x TGJ2.512 (12")	
	4 x TGJ2.518 (18")	
	8 x TGJ2.524 (24")	
	4 x TGJ2.530 (30")	
	4 x TGJ2.536 (36")	

**N**



# Specialty all-steel clamps



## Specialty all-steel step-over bar clamps

The J Series clamps are a total lifesaver in the workshop! Not everything in the shop is flat and this clamp offers a solution to clear obstructions and maintain clamping pressure. Comes with standard swivel pad built for solid, dependable, performance.

- 1 Extremely sturdy**  
The return rail lets the J clamps “step-over” the lip on channel iron, angle-iron, I-beam or other obstructions.
- 2 BESSEY® MorPad**  
MorPad tilts to 35°. Patented construction extends clamp life at full capacity (2400J and 4800J).
- 3 Forged sliding arm**  
Forged sliding arm is made from tempered, drop-forged steel for long service life.
- 4 Tempered spindle**  
Heat treated, high carbon Acme threaded screw - tempered and quenched to give greater load capacity with longer service life. Spatter resistant.
- 5 Sturdy T-bar**  
High-strength electro-galvanized sliding pin T-handle - rounded ends for comfort, size engineered to load capacity.



A



### A Light duty step-over clamps, J series

The J Series clamps are a total lifesaver in the workshop! Not everything in the shop is flat and this clamp offers a solution to clear obstructions and maintain clamping pressure. Comes with standard swivel pad built for solid, dependable, performance.

	Clamping Capacity	Throat Depth	Clamping Force	Rail Step-Over Up to	Approx. Weight
<b>J18-8</b>	10"	4 3/4"	880 lbs	2 1/4"	3.20 lbs



B



### B Regular duty step-over clamps with pad, 2400J series

Features BESSEY® MorPad to reduce friction at the point of contact, increasing and optimizing clamping force. BESSEY® MorPad also extends tool life, and at full pressure. Ergonomic grip is standard on the 2400J series.

	Clamping Capacity	Throat Depth	Clamping Force	Rail Step-Over Up to	Approx. Weight
<b>2400J-12</b>	12"	5 1/2"	2660 lbs	4"	8.00 lbs

Ball-in-socket technology for greatly extended clamp life and, at full pressure... by BESSEY®. Patented.





**C Heavy duty step-over clamps with pad, 4800J series**

Features BESSEY® MorPad to reduce friction at the point of contact, increasing and optimizing clamping force. BESSEY® MorPad also extends tool life, and at full pressure.

	Clamping Capacity	Throat Depth	Clamping Force	Rail Step-Over Up to	Approx. Weight
<b>4800J-20</b>	20"	7"	4880 lbs	6"	17.35 lbs



**D Regular duty, deep throat version, DT 2400 series**

This series has an extended throat depth of 8 In for that extra reach that is sometimes needed. Comes with: Standard rail profile, MorPad, ergonomic BESSEY® grip.

	Clamping Capacity	Throat Depth	Clamping Force	Approx. Weight
<b>DT 2400-12</b>	12"	8"	1770 lbs	7.50 lbs
<b>DT 2400-24</b>	24"	8"	1770 lbs	9.60 lbs



**E Claw clamp, CL**

A welder's versatile clamp or spreader. The spindle mechanism is on the back side of the sliding arm so that it is out of the work area. The V-grooved pressure plate is made of high grade cast iron and swivels up to 30°. Jaw reverses to act as a spreader.

	Clamping Capacity	Throat Depth	Clamping Force	Approx. Weight
<b>CL24</b>	24"	4 3/4"	1775 lbs	7.10 lbs
<b>CLS-Shoe</b>				0.75 lbs
<b>3101590</b>	Replacement arm			



**F Multi-Purpose KombiKlamp™**

The KombiKlamp™ has great features that make it very versatile. It is set up to clamp, spread, hold irregular shaped objects and even comes with an ergonomic grip. Made in Germany, the clamp is set at a price point to make it a serious consideration for the active shop.

	Clamping Capacity	Throat Depth	Clamping Force	Approx. Weight
<b>SG30VAD</b>	*12"	4 3/4"	2600 lbs	6.44 lbs

\* 11 inch capacity with VAD in place. Spreading from 9-20".



**G OMEGA bend clamps, RSC series**

Thanks to the patented OMEGA bend this clamp maintains its positive clamping pressure longer under heavy vibration than a conventional clamp. It is durable, lightweight and easy to use.

	Clamping Capacity	Throat Depth	Clamping Force	Approx. Weight
<b>RSC-8</b>	8"	4"	770 lbs	1.90 lbs
<b>RSC-12</b>	12"	5 1/2"	1100 lbs	4.05 lbs
<b>RSC-18</b>	18"	4 3/4"	1100 lbs	4.90 lbs
<b>RSC-24</b>	24"	4 3/4"	1100 lbs	5.40 lbs



# Double force variable clamps

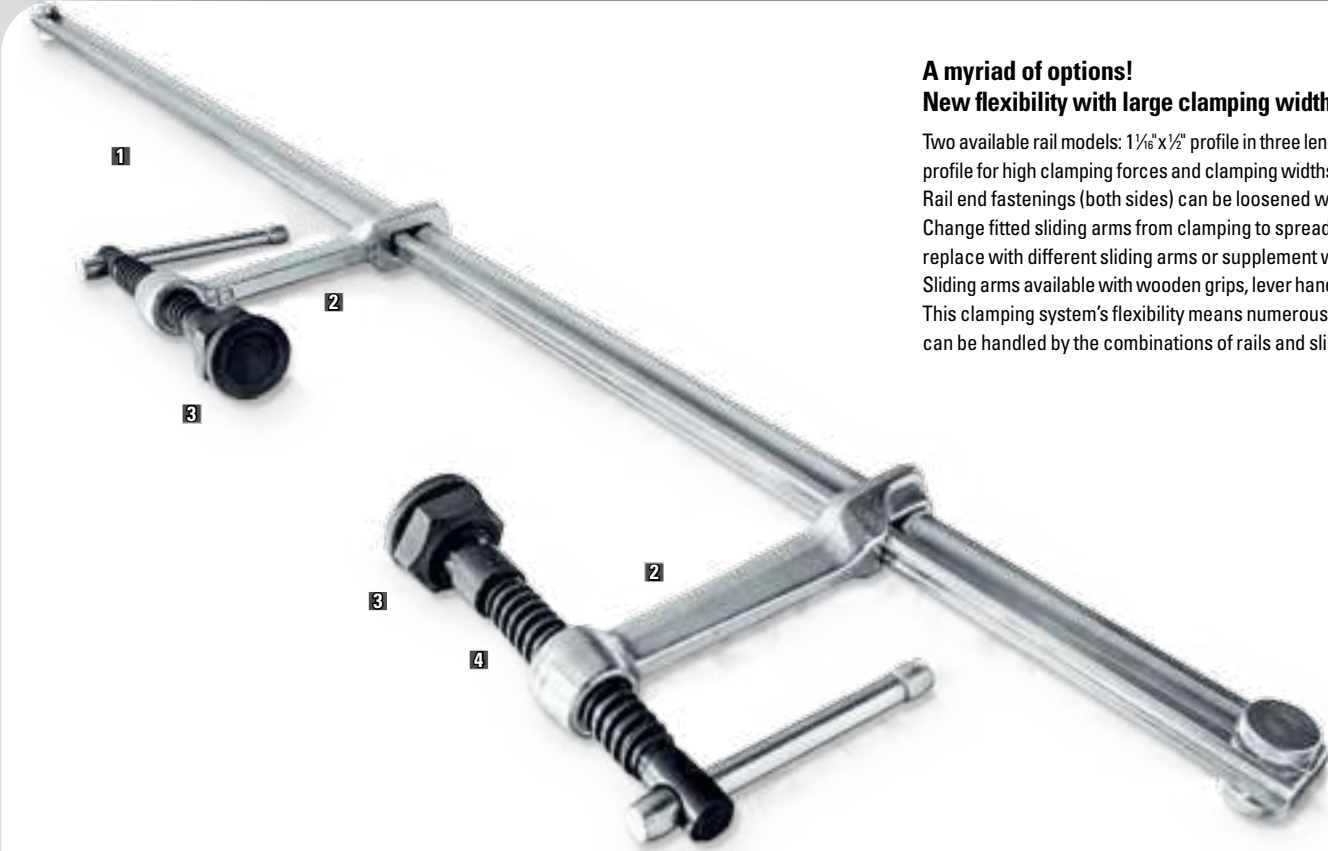

## A myriad of options! New flexibility with large clamping widths

Two available rail models: 1 1/16" x 1/2" profile in three lengths; 1 3/16" x 5/8" profile for high clamping forces and clamping widths up to 118". Rail end fastenings (both sides) can be loosened without tools. Change fitted sliding arms from clamping to spreading or replace with different sliding arms or supplement with others. Sliding arms available with wooden grips, lever handles or T-Bars. This clamping system's flexibility means numerous applications can be handled by the combinations of rails and sliding arms.



### A Double force all-steel clamps – Complete Set Options

- Tipping is prevented through central positioning on the workpiece
- Long service life thanks to special heat resistant pressure plate with sintered steel insert, can be tilted by up to 35°
- Clamp can be fed through an opening in the workpiece/component

	Suitable for	Profile Size	Clamping Capacity	Throat Depth	Clamping Force	Approx. Weight
<b>SLV40M</b>	SLV	1 1/16" x 1/2"	16"	4 3/4"	1,450 lbs	6.85 lbs
<b>SLV100M</b>	SLV	1 1/16" x 1/2"	39 1/2"	4 3/4"	1,450 lbs	10.50 lbs
<b>SLV150M</b>	SLV	1 1/16" x 1/2"	60"	4 3/4"	1,450 lbs	13.13 lbs
<b>SLV200M</b>	SLV	1 1/16" x 1/2"	79"	4 3/4"	1,450 lbs	15.73 lbs
<b>GSV300M</b>	GSV	1 3/16" x 5/8"	118"	5 1/2"	2,000 lbs	28.60 lbs



### B Rails for Sliding Arms

Create your own custom clamp by first choosing a rail style and length, then adding the desired clamp surfaces (see C and D).

- Cold drawn and galvanised
- End fastenings – on both ends – can be loosened without tools for rapid changeover

	Suitable for	Profile Size	Length	Approx. Weight
<b>3101731</b>	SLV	1 1/16" x 1/2"	47"	6.28 lbs
<b>3101732</b>	SLV	1 1/16" x 1/2"	67"	8.92 lbs
<b>3101733</b>	SLV	1 1/16" x 1/2"	87"	11.57 lbs
<b>3101612</b>	GSV	1 3/16" x 5/8"	130"	23.00 lbs

## Modular concept for the widest range of applications

### 1 End fastenings can be loosened without tools

Both ends can be loosened without tools enabling rapid changeover of the sliding arms for spreading tasks. Replace the sliding arms or add additional sliding arms easily.

### 2 Interchangeable sliding arms

Made from forged tempered steel the sliding arms offer a high level of security as the linear transfer of forces can withstand large loads. Replace with other sliding arm variants to suit the application, or supplement with others.

### 3 BESSEY® heavy duty MorPad

Heavy duty MorPad is designed to reduce friction at the point of contact; which can lower applied clamping force. Longer service life due to the heat-resistant pressure plate with sintered steel insert, which can be tilted up to 35°.

### 4 Tempered spindle

Sturdy Acme spindle is wear-resistant, considerably increasing its durability.

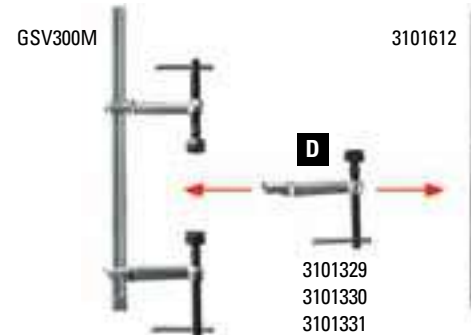
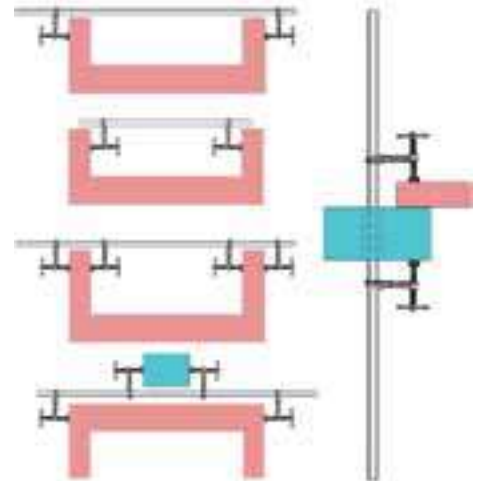

### C Complete sliding arm for SLV sizes

- Three different grip variants/designs with different throat depths
- Suitable for all SLV size rails with 27 mm x 13 mm rail

	Description	Throat Depth	Approx. Weight
3101426	Wooden handle	4 3/4"	1.60 lbs
3101337	Lever handle	4 3/4"	2.40 lbs
3101338	T-Bar	4 3/4"	1.80 lbs

### D Complete sliding arm for GSV sizes

- One arm design with three throat depths
- Suitable for GSV size rails with rail profile 30 mm x 15 mm
- T-Bar includes high-performance pressure plate with sintered steel insert

	Throat Depth	Approx. Weight
3101329	4 3/4"	2.50 lbs
3101330	5 1/2"	2.70 lbs
3101331	7 1/2"	3.10 lbs

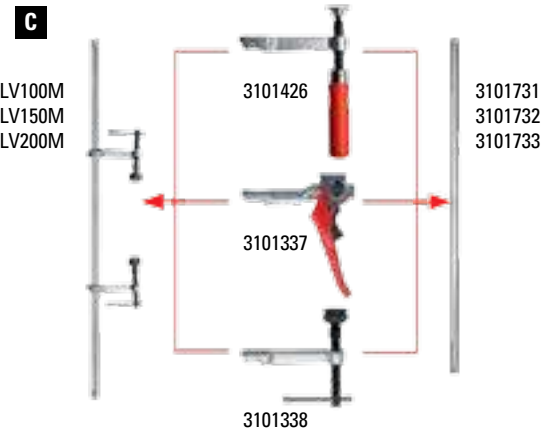

### E MorPads

- 3100736 Smooth face (standard) - SLV or GSV Series
- 3101192 Rough face - SLV or GSV Series
- 3101193 V Groove - SLV or GSV Series

### F Complete spindle assembly

- 3100398 SLV Spindle (.700" Dia.)
- 3100399 GSV Spindle (.775" Dia.)
- 3101782 End fastener set, SLV / GSV rail

### G Variable angle device

- VAD Fits SLV and GSV

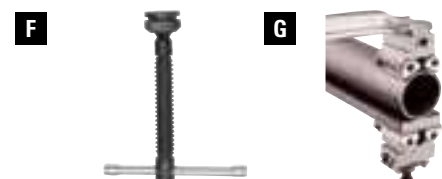



# Rapid-Action lever clamps

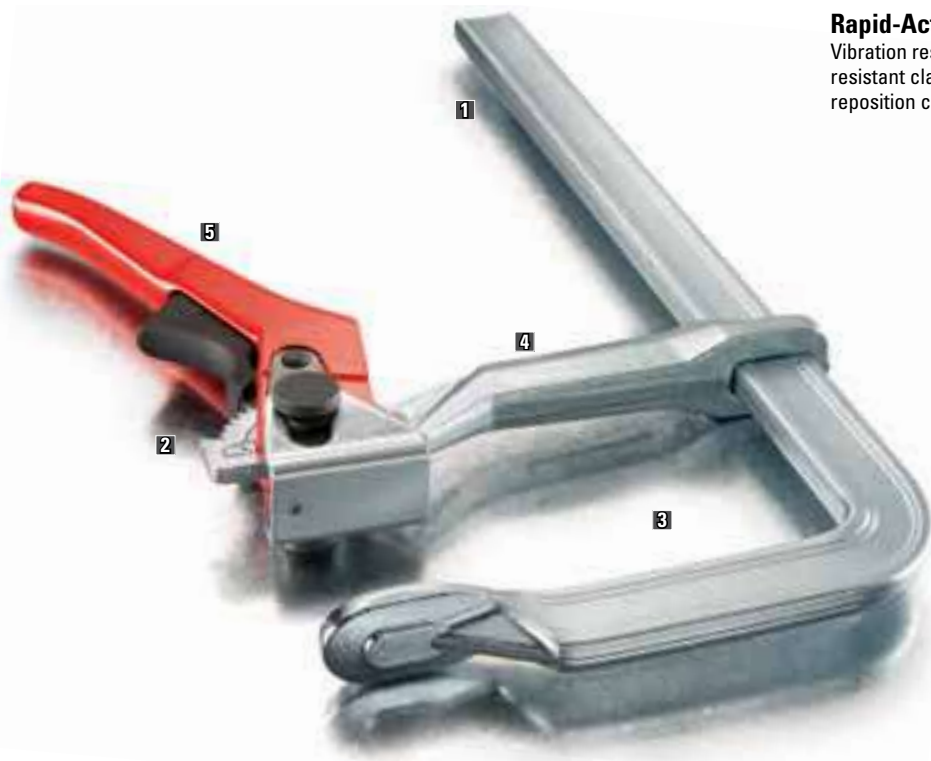

## Rapid-Action lever clamps

Vibration resistant. quick action. Quick on, quick off! Secure vibration-resistant clamping with a rapid action ratchet mechanism. Position and reposition clamps quickly and securely.

### 1 Patented rail profile, LC series

The patented rail profile offers greater stability, enhanced clamping force and 20% more clamping force for quicker set-up times.

### 2 Secure ratchet mechanism

Ratchet mechanism ensures rapid, vibration-resistant clamping. The hardened cam at the end of the lever ensures a long service life. Trigger protection means fewer pinched fingers.

### 3 Extremely sturdy

Torsion-resistant, fixed jaw and pressure plate are produced and tempered in one piece for maximum tensile strength and sturdiness.

### 4 Forged Sliding Arm

Forged sliding-arm is made from tempered, drop-forged steel for long service life.

### 5 Extremely Sturdy Handle

Ergonomically shaped powder-coated clamping lever and plastic-coated release for comfort and power.



A

## A All-steel lever bar clamps

Quick – up to 5 times faster than regular clamps! Secure, unaffected by vibrations. Strong – high clamping force. Non-slip trigger release. Patented profiled rail.



	Clamping Capacity	Throat Depth	Clamping Force	Approx. Weight
LC4	4"	2 3/8"	400 lbs	1.10 lbs
LC8	8"	4"	660 lbs	2.45 lbs
LC12	12"	5 1/2"	1200 lbs	4.95 lbs
LC20	20"	4 3/4"	1200 lbs	5.80 lbs
LC31	31"	4 3/4"	1200 lbs	6.95 lbs
1800L12	10"	5 1/2"	1800 lbs	7.35 lbs



1800L12:  
Arm folds to stay out of your way!



B

## B classIX® GSH all-steel lever bar clamps

Quick – up to 5 times faster than regular clamps! Secure, unaffected by vibrations. Strong – high clamping force. Non-slip trigger release. Classic profiled rail.



	Clamping Capacity	Throat Depth	Clamping Force	Approx. Weight
GSH12	4"	2 3/8"	400 lbs	1.10 lbs
GSH20	8"	4"	600 lbs	2.50 lbs
GSH30	12"	5 1/2"	1110 lbs	5.00 lbs
GSH50	20"	4 3/4"	1110 lbs	6.25 lbs

## Light duty lever clamp

### The lightweight clamp made of magnesium

This lightweight lever clamp creates up to 260 lbs. of clamping force, quickly. The positive locking ratchet action will not loosen due to vibration. It's surface-coated fixed & sliding arms are made from sturdy magnesium which makes it lightweight & strong. The fixed arm with v-grooves holds round, pointed & angular components firmly in place. Ergonomically shaped clamping arm is made from fiberglass-reinforced polyamide. This clamp is quick, easy, & gentle.

- 1 Sturdy magnesium**  
Magnesium jaws are extremely light and strong.
- 2 Multi-stage ratchet mechanism**  
Ratchet mechanism is vibration-resistant, making it great for use with power tools.
- 3 Secure hold**  
The fixed arm with crossed v-grooves holds round, pointed or angular components firmly in place.
- 4 Ergonomically shaped clamping arm**  
Durable, fiberglass-reinforced, polyamide clamping arm ergonomically designed for comfort and power.



### A KliKlamp® light duty lever clamp

Light as a feather – tough as nails; it's perfect for your workshop. Clamping force up to 260 lbs. Sturdy fixed and sliding arms made from lightweight magnesium. Quick, and vibration resistant, clamping.

	Clamping Capacity	Throat Depth	Clamping Force	Approx. Weight
<b>KLI3.004</b>	4"	3"	260 lbs	0.53 lbs
<b>KLI3.008</b>	8"	3"	260 lbs	0.67 lbs
<b>KLI3.012</b>	12"	3"	260 lbs	0.83 lbs
<b>KLI3.016</b>	16"	3"	260 lbs	0.97 lbs



**Check out KliKlamp® in action!**

**Please reference our YouTube videos showing BESSEY® products in action.**

# Clamping angles and miters

## Clamping angles and miters

BESSEY® metal angle clamps are specifically designed to hold demanding welding or steel fabrication settings. Tough and versatile, these tools simplify the work process.

### 1 Right angle clamping

The angle clamps have been developed for a wide range of applications but, most especially for aligning materials at 90 degrees for welding.

### 2 Work pieces of different thickness

The copper spindle passes through an articulated bearing that then attaches to a swivel based face. In use, the jaw face will automatically adjust to different thickness work pieces to align them at a 90 degree angle.

### 3 Open work area

Allows passage of T-joints for easy access to final fastening.

### 4 Stable and solid

High quality cast-iron construction with wide bases and broad hold down areas to fasten the angle clamp safely.



### A Angle clamps, WSM

Joining two pieces of metal at a 90 degree angle has never been easier thanks to the BESSEY® angle clamp. Let the clamp do the work while you do the welding. Even pieces of different thicknesses are no match for this clamp.



	Capacity for both sides	Jaw Height	Max. Passage for Mitres	Approx. Weight
<b>WSM-9</b>	7"	1 3/8"	3 1/2"	8.00 lbs
<b>WSM-12</b>	9 1/2"	2 3/8"	4 3/4"	16.10 lbs
<b>3100953</b>	WSM-9 Spindle Assembly			
<b>3100954</b>	WSM-12 Spindle Assembly			



### B Multi-angle vise clamp, WVS, 3-in-1 angle clamp

The BESSEY® WVS-4 allows an unusually versatile range of clamping positions. The two individual vises are mounted to a base plate and rotate freely. This allows angle clamping from 5 to 180 degrees and the added flexibility of using the smaller vises independently. Terrific value.



	Clamping Capacity	Jaw Height	Range of Angle	Approx. Weight
<b>WVS-4</b>	4 3/8"	1 3/8"	5° to 180°	22.80 lbs



## Clamping angles and miters

Single spindle design of the WS-3 and WS-6 is quick & easy to use. Free floating jaw allows you to clamp dissimilar thickness/width work pieces together at a perfect 90°. Purchase a pair of TK-6 table-clamps to use when you want to clamp your WS-3 or WS-6 clamp to your work surface.

- 1 Sturdy frame**  
Die-cast jaws are plastic coated to protect work.
- 2 Versatility**  
Designed for clearance of dowels, screws or staples while gluing.
- 3 Right angle clamping**  
Holds and aligns material at 90° angle.
- 4 BESSEY® comfort handle**  
Includes either the tried-and-true wooden handle or 2K composite handle with comfort insert.
- 5 Adjustable**  
Automatically adjust to hold two different sizes of wood together.



### A Angle clamp, WS

Ideal for clearance of dowels, screw or staples while gluing. It holds and aligns material at 90° angles and even adjusts automatically to wood thickness. Use the TK-6 table mount clamp to hold the clamp in place (included with 2K version).

	Handle Style	Maximum Clamping Capacity	Max. Passage for T-Joints	Approx. Weight
<b>WS-3+2K</b>	2K	Both sides-max 4" thick	1 3/16"	2.40 lbs
<b>WS-6</b>	Wood	Both sides-max 8" thick	2 1/16"	4.80 lbs
<b>TK-6</b>	<b>Table Mount Clamp Accessory, TK</b> Holds WS to work surface, 2/set (included with 2K version)			



### B Corner clamp, WS

An economical alternative for fixed 90° angle for miter or butt joints. Use the mounting holes to fix the corner clamp to your work surface. Can be adjusted to various sized work pieces with the 2 spindles. Made for light duty clamping.

	Clamping Capacity	Angle	Approx. Weight
<b>WS-1</b>	Up to 3" per side	90°	0.50 lbs



# I-Beam clamps

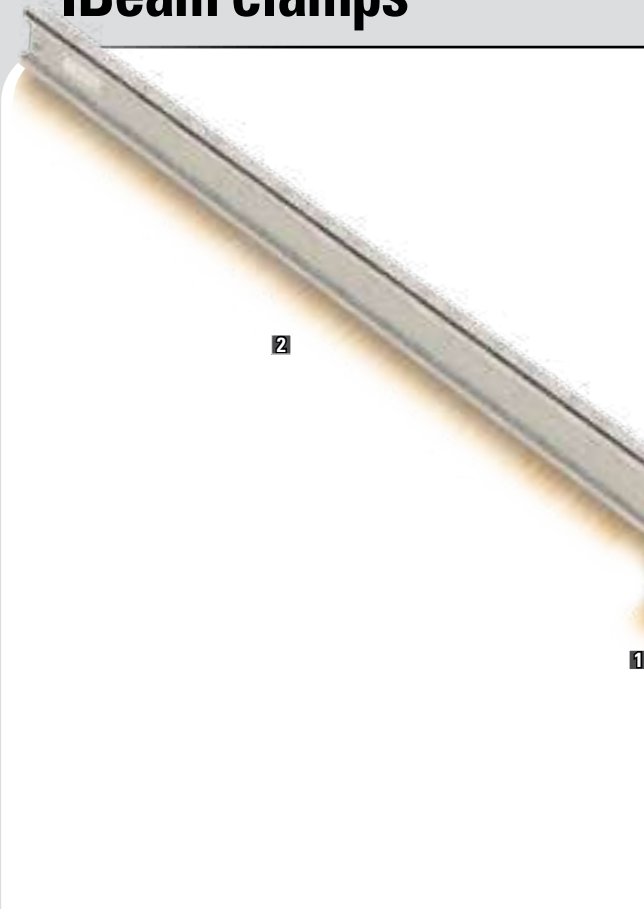

## Heavy duty steel bar clamps

Designed to meet the demanding needs of industrial workloads, IBeam is very stiff and much better at resisting bend or twist over a long distance than other clamps. For powerful clamping of all types, where strength and straightness over a distance are crucial. BESSEY® IBeam clamps are ideal for high-demand industrial & institutional woodworking. Available in lengths from 24" to 96".

- 1 Tough ductile castings**  
Powder coated
- 2 Nickel plated rail**  
Resists corrosion
- 3 5 strong, hardened steel clutch plates**  
To aid with gripping the bar stock
- 4 Crank handle**  
Tremendous strength & long term durability
- 5 ACME threaded screws**  
With 9/16" spindle diameter



### A Heavy duty IBeam steel bar clamp

The IBeam rail's hourglass profile contributes to the clamp's ability to resist flex over a greater clamping span.

	Clamping Capacity	Throat Depth	Jaw Width	Clamping Force	Pieces Shipped	Approx. Weight
<b>IBEAM24</b>	24"	2"	1 3/4"	7000 lbs	2	8.32 lbs
<b>IBEAM30</b>	30"	2"	1 3/4"	7000 lbs	2	9.07 lbs
<b>IBEAM36</b>	36"	2"	1 3/4"	7000 lbs	2	9.80 lbs
<b>IBEAM48</b>	48"	2"	1 3/4"	7000 lbs	2	11.25 lbs
<b>IBEAM60</b>	60"	2"	1 3/4"	7000 lbs	2	12.75 lbs
<b>IBEAM72</b>	72"	2"	1 3/4"	7000 lbs	2	14.20 lbs
<b>IBEAM84</b>	84"	2"	1 3/4"	7000 lbs	2	15.70 lbs
<b>IBEAM96</b>	96"	2"	1 3/4"	7000 lbs	2	17.20 lbs

### B BESSEY® IBeam clamp service parts

- 203715** Handle, spindle, jaw
- 203722** Clutch assembly



### C T-bar sash clamps, TB

	Clamp Face	Clamping Capacity	Clamping Force	Approx. Weight
<b>TB100</b>	2.6" x 1.7"	39"	3150 lbs	18.00 lbs
<b>TB150</b>	2.6" x 1.7"	59"	2600 lbs	23.00 lbs
<b>TB250</b>	2.6" x 1.7"	98"	2100 lbs	33.00 lbs

### D BESSEY® TB clamp service parts (Special order)

- 3101793** Pressure jaw
- 3101792** Screw guide
- 3100920** Clamping jaw
- 3101405** Screw set

# Pipe clamps

## Pipe clamps

Commonly used in woodworking applications for edge gluing of multiple pieces. The versatility of the reach comes from the ability to use a variety of lengths of pipe to suit your needs.

- 1 Foot assembly**  
Foot assembly stabilizes clamp.
- 2 Extra high base**  
Extra high base provides finger-saving clearance from the work surface.
- 3 Cast jaws**  
Cast jaws for durability.
- 4 Smooth spindle with Hex head\***  
Smooth action spindle. Hex head on PC-2 model

\*Hex head spindle is to facilitate clamping, not augment it. Applying too much clamping force may cause the fixture to fail.

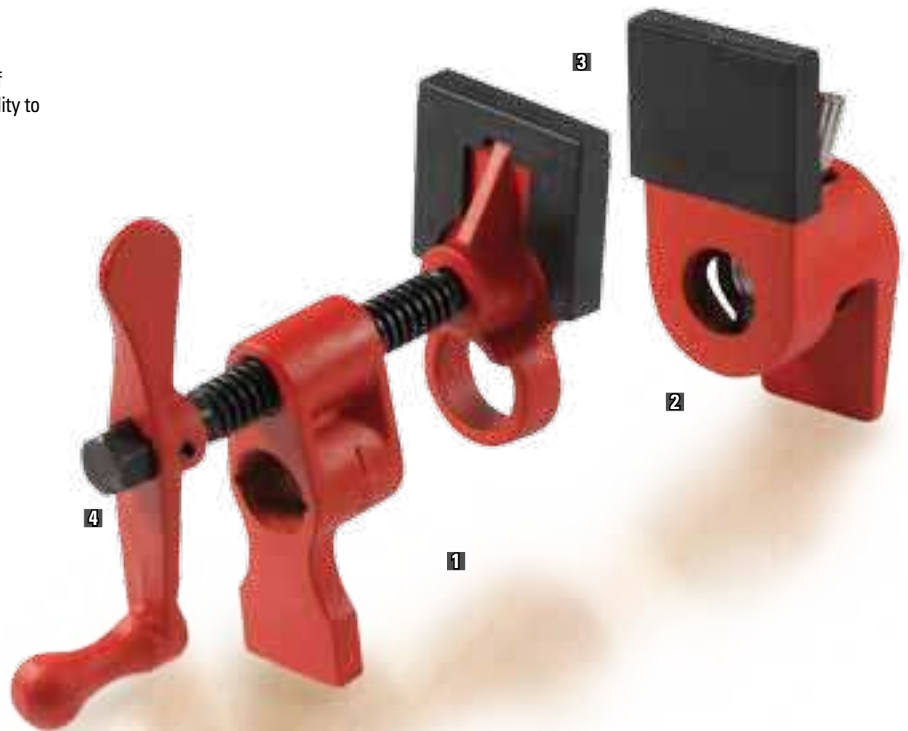

### A Pipe clamp, traditional style, PC-2

Large clamping surface. ACME threaded screw. Hex head on spindle. High base improves clearance from the work surface. An economical alternative to the bar clamp.

	Black Pipe Diameter	Throat Depth	Approx. Weight
<b>PC34-2</b>	3/4"	2 3/8"	2.74 lbs
<b>PC12-2</b>	1/2"	2 1/8"	2.02 lbs

Replacement pad sets: **PC34-2-PADS, PC12-2-PADS**



### B Pipe clamp, H style, BPC

"H" shape foot assembly stabilizes clamp in two dimensions giving dual-axis stability. Extra high base offers clearance between the handle and work surface.

	Black Pipe Diameter	Throat Depth	Approx. Weight
<b>BPC-H34</b>	3/4"	2 1/8"	2.88 lbs
<b>BPC-H12</b>	1/2"	1 1/8"	1.83 lbs

Replacement pad sets: **BPC-H34-PADS and BPC-H12-PADS**



### C Deep reach pipe clamp, traditional style, PC-DR

The traditional pipe clamp features ACME threaded spindle and some extra deep reach!

	Black Pipe Diameter	Throat Depth	Approx. Weight
<b>PC-34DR</b>	3/4"	2 1/2"	2.15 lbs

Replacement pad sets: **PC-34DR-PADS**





# For flexible, featherlight clamping

## VarioClippix® spring clamps

A clever variation on the standard spring clamp, VarioClippix® clamp handles hold fast at a constant setting for steadfast gluing bonds. An upper jaw is infinitely adjustable & opens as wide as 3 inches (100 mm), making the Clippix versatile enough to do the work of four different clamps. VarioClippix clamps function at any angle for optimal versatility. The moveable jaw and a spring clamp together let you quickly and easily modify clamping pressure from maximum force for feisty projects, to almost no force for delicate applications. Handles are made of a two-component, soft, anti-slip material for comfort. Soft pads on the tips eliminate marring of work piece for smoother, straighter clamping.

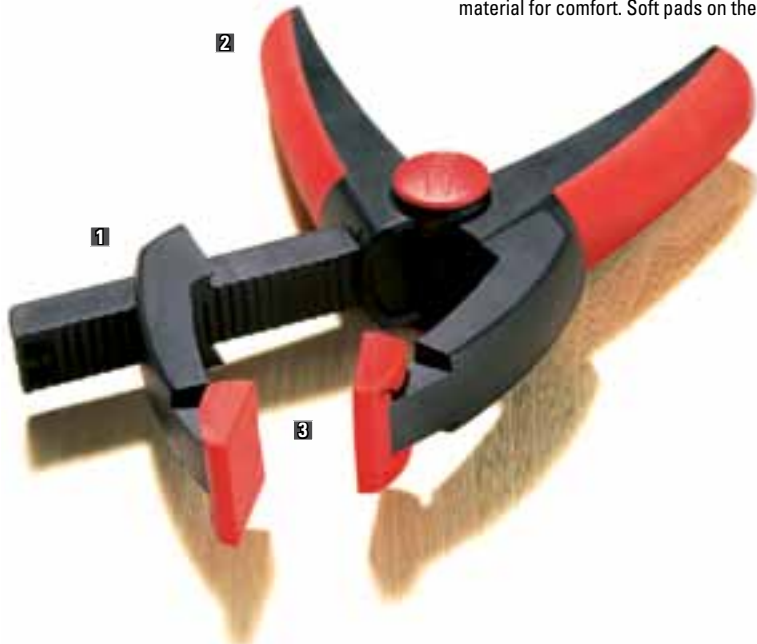

### 1 Sliding clamping arm

Rapid-action, polyamide, sliding top jaw infinitely adjusts to fit the project... the clamping capacity of a 4" spring clamp with the comfort of a 2" clamp.

### 2 Ergonomic 2-component handle

Soft, anti-slip two component handle for comfort.

### 3 Softpads

Soft-touch pads protect sensitive workpieces and eliminate marring of work.



### A VarioClippix®, XV variable spring clamp

A unique design that allows you to adjust the sliding jaw, offering a much larger clamping capacity than a regular spring clamp.

	Clamping Capacity	Throat Depth	Approx. Weight
XV5-100	4"	2"	0.28 lbs



### B VarioClippix®, XV double jaw variable spring clamp

A second sliding arm expands clamping capacity up to 6 1/2". This versatile clamp can be operated with one hand and is lightweight, functional and extremely stable.

	Clamping Capacity	Throat Depth	Approx. Weight
XV5-170	6 1/2"	2"	0.34 lbs

### C Clippix® plastic spring clamps

Choose from a long tapered nose for those hard to reach spaces or a premium spring clamp for those light duty jobs. Both made with an ergonomic 2-component handle, and lightweight polyamide jaws.

	Clamping Capacity	Throat Depth	Approx. Weight
<b>Needle nose plastic spring clamps, XCL</b>			
XCL2	2"	2"	0.05 lbs
XCL2-Set (2xXCL2)	2"	2"	0.15 lbs
XCL5	3"	4"	0.30 lbs
<b>Premium plastic spring clamps, XC</b>			
XC1	¾"	¾"	0.02 lbs
XC2	1"	1 ⅛"	0.05 lbs
XC3	1 ⅜"	1 ½"	0.10 lbs
XC5	2"	1 ⅝"	0.25 lbs
XC7	3"	2 ¾"	0.40 lbs



### D Ratcheting spring clamp, XCRG

Features heavy duty resin construction. Great for light duty jobs that require a deeper throat depth. Easy to attach and a quick one-hand release makes this perfect for everyday use. Ergonomic 2-component handle. Rapid-action clamping with positive locking mechanism and riveted pivoting clamp for secure clamping on a variety of shapes and work surfaces and pads won't fall off.

	Clamping Capacity	Throat Depth	Approx. Weight
XCRG2	2 ¼"	2"	0.42 lbs
XCRG4	4"	3"	0.55 lbs



### E Clippix®, XC plastic spring clamp set

A light duty plastic spring clamp that is perfect for the home or shop.

	Includes	Approx. Weight
XC-14PC	2 x 3" clamps, 2 x 2" clamps, 4 x 1" clamps, 6 x ¾" clamps	2.06 lbs



### F Steel spring clamps, XM

Made with vinyl tips to prevent marring and vinyl handles for a non-slip grip. Features a heavy duty spring for a tight fit and nickel plating to prevent corrosion.

	Clamping Capacity	Throat Depth	Approx. Weight
XM3	1"	1 ¼"	0.16 lbs
XM5	2"	2 ¼"	0.36 lbs
XM7	3"	3 ⅝"	0.80 lbs
XM10	4"	5"	1.15 lbs
<b>Black with pads and tip</b>			
XM3-B	1"	1 ¼"	0.16 lbs
XM5-B	2"	2 ¼"	0.36 lbs
XM7-B	3"	3 ⅝"	0.80 lbs
<b>No pads, no tips</b>			
XM3-NPT	1"	1 ¼"	0.13 lbs
XM5-NPT	2"	2 ¼"	0.32 lbs
XM7-NPT	3"	3 ⅝"	0.70 lbs
XM10-NPT	4"	5"	1.00 lbs



# Trigger clamps

**NEW**

## EHK Trigger Clamp

What separates the BESSEY® trigger clamp from the rest is that it has been engineered from the start to offer a clean design, comfortable handles, up to 600 lbs. of potential clamping force and the ability to quickly transform from clamping to spreading. The transition from clamping to spreading requires no tools. All that is required is a quick push of the locking mechanism to disengage the fixed jaw, move it to the opposite end of the rail and re-engage.



**1 Powerful technology, robust construction**

One-handed clamping or spreading of work pieces with up to 600 lbs. of force.

**2 No tools required**

No tools required to easily convert from clamping to spreading; push button jaw release.

**3 Soft touch pads**

Soft-touch jaw pads eliminate marring of work, and they're removable too. Steel bar for the strength you expect from BESSEY.

**4 Ergonomic composite handle**

Ergonomically shaped composite handle with trigger makes it easy to achieve maximum clamping force.



**A Trigger clamps, EHK series**

BESSEY's already broad range of one hand clamps has now grown farther to offer a full line of trigger clamps. A robust construction allows a range of clamping force from 40 lbs to 600 lbs.

	Clamping Capacity	Throat Depth	Clamping Force	Approx. Weight
<b>EHKMICRO</b>	4 1/2"	1 5/8"	40 lbs	0.13 lbs
<b>EHKM06</b>	6"	2 3/8"	100 lbs	0.69 lbs
<b>EHKM12</b>	12"	2 3/8"	100 lbs	0.84 lbs
<b>EHKL06</b>	6"	3 1/8"	300 lbs	1.28 lbs
<b>EHKL12</b>	12"	3 1/8"	300 lbs	1.49 lbs
<b>EHKL18</b>	18"	3 1/8"	300 lbs	1.69 lbs
<b>EHKL24</b>	24"	3 1/8"	300 lbs	1.90 lbs
<b>EHKL36</b>	36"	3 1/8"	300 lbs	2.32 lbs
<b>EHKXL06</b>	6"	3 5/8"	600 lbs	2.37 lbs
<b>EHKXL12</b>	12"	3 5/8"	600 lbs	2.74 lbs
<b>EHKXL18</b>	18"	3 5/8"	600 lbs	3.10 lbs
<b>EHKXL24</b>	24"	3 5/8"	600 lbs	3.45 lbs
<b>EHKXL36</b>	36"	3 5/8"	600 lbs	4.17 lbs
<b>EHKXL50</b>	50"	3 5/8"	600 lbs	5.06 lbs





# EZ, DuoKlamp®, PowerGrip

## B One-handed EZ clamps

A lightweight version of EZS – with 150 lbs of clamping force, the ability to transition smoothly from clamping to spreading, and all the dependability you've come to expect from BESSEY®.

	Clamping Capacity	Throat Depth	Clamping Force	Spreading	Approx. Weight
EZ15-6	6"	2 3/8"	150 lbs	5" - 12"	0.66 lbs
EZ30-6	12"	2 3/8"	150 lbs	5" - 18"	0.83 lbs



## C DuoKlamp®, large surface one handed clamp

Clamp or spread with the turn of a button, no tools necessary with the intelligent release mechanism. Jaws are designed to resist flex and are capable of withstanding up to 260 lbs of clamping force. Soft pressure caps slide off easily and prevent marring of wood by distributing pressure over a greater area.

	Clamping Capacity	Throat Depth	Clamping Force	Spreading	Approx. Weight
DUO16-8	6"	3 1/4"	260 lbs	2 3/4" - 9 1/4"	1.42 lbs
DUO30-8	12"	3 1/4"	260 lbs	2 3/4" - 14 3/4"	1.53 lbs
DUO45-8	18"	3 1/4"	260 lbs	2 3/4" - 21"	1.87 lbs
DUO65-8	24"	3 1/4"	260 lbs	2 3/4" - 26 3/4"	2.19 lbs



## D One-handed EZS clamps

The EZS One Hand Clamp by BESSEY® offers a revitalized approach to the one hand clamp market. What makes it so new and fresh is that it has been engineered from the start to offer clean design lines, comfortable handles, 445 lbs of clamp force and the ability to transition smoothly from clamping to spreading.

	Clamping Capacity	Throat Depth	Clamping Force	Spreading	Approx. Weight
EZS15-8	6"	3 1/2"	445 lbs	6 1/2" - 14"	1.53 lbs
EZS30-8	12"	3 1/2"	445 lbs	6 1/2" - 20"	1.79 lbs
EZS45-8	18"	3 1/2"	445 lbs	6 1/2" - 25 3/4"	2.00 lbs
EZS60-8	24"	3 1/2"	445 lbs	6 1/2" - 31 3/4"	2.28 lbs
EZS90-8	36"	3 1/2"	445 lbs	6 1/2" - 43 1/2"	2.80 lbs



## E PowerGrip, PG, heavy duty one-hand clamp

A truly one-handed clamp that is easy to use. To preadjust the jaw use the easy slide button to position it quickly with just one hand; then squeeze the handle to hold the clamp in place; and simply turn the handle to apply the full pressure. Comes with removable soft pressure caps.

	Clamping Capacity	Throat Depth	Clamping Force	Approx. Weight
PG12	12"	4"	1000 lbs	2.75 lbs
PG24	24"	4"	1000 lbs	3.70 lbs
3101402	PG Pad Set			



# Self-adjusting toggle clamps

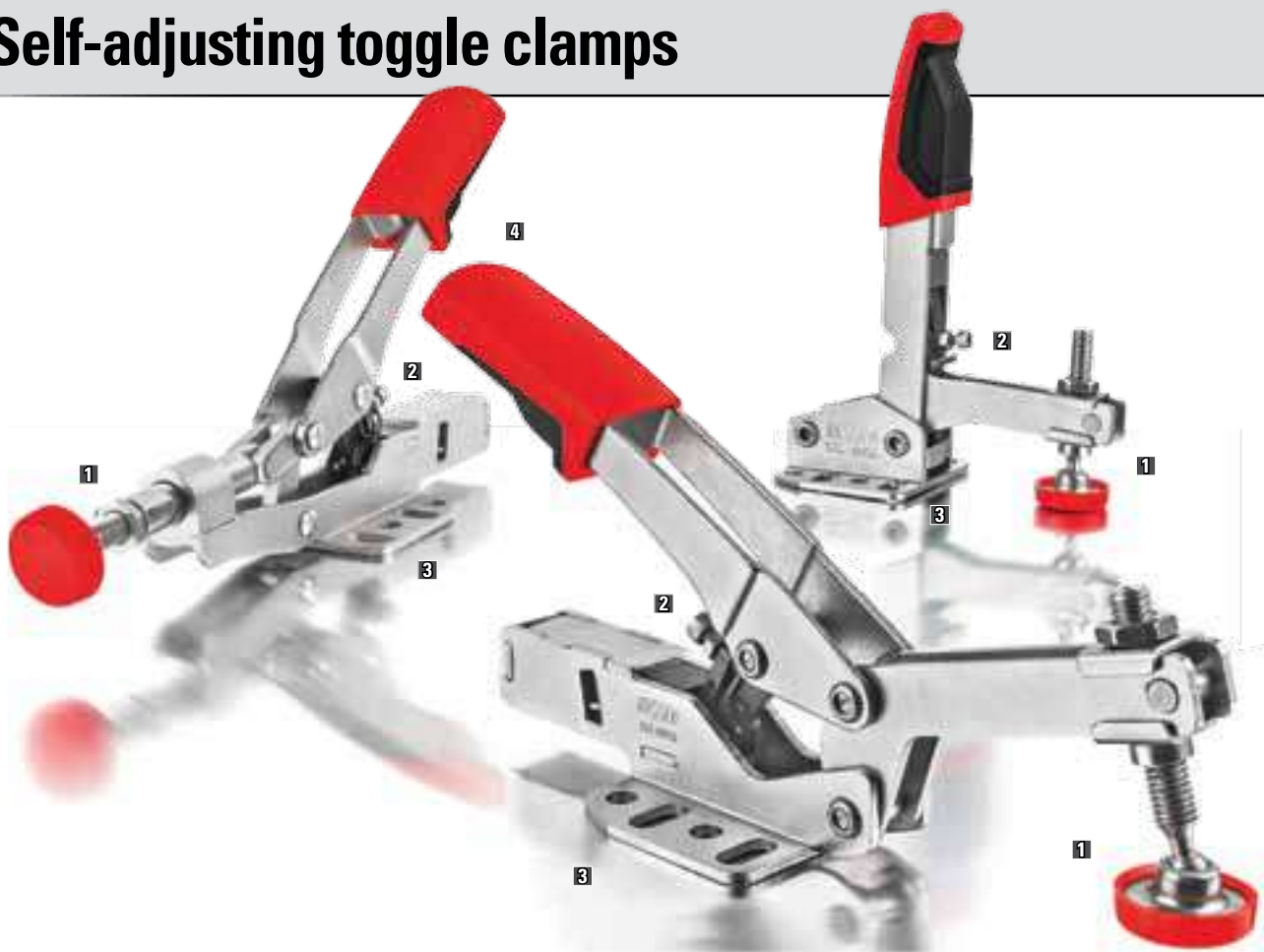

**A**

**A Vertical toggle with open arm and horizontal base plate**

	Clamping Capacity	Automatic Adjust	Nominal Clamping Force Range	Holding Capacity	Approx. Weight	Fastener
<b>STC-VH20</b>	13/16"	3/4"	25 - 250 lbs.*	450 lbs.	0.44 lbs.	3/16" or M5
<b>STC-VH50</b>	1 9/16"	1 3/8"	25 - 550 lbs.*	700 lbs.	0.94 lbs.	1/4" or M6
<b>3101627</b>	STC-VH20 Spindle service part set					
<b>3101589</b>	STC-VH50 Spindle service part set					



**B**

**B Inline toggle with flanged base plate**

	Clamping Capacity	Automatic Adjust	Nominal Clamping Force Range	Holding Capacity	Approx. Weight	Fastener
<b>STC-IHH15</b>	3/8"	5/16"	25 - 250 lbs.*	450 lbs.	0.41 lbs.	3/16" or M5
<b>STC-IHH25</b>	5/8"	1/2"	25 - 550 lbs.*	700 lbs.	0.88 lbs.	1/4" or M6
<b>3101627</b>	STC-IHH15 Spindle service part set					
<b>3101589</b>	STC-IHH25 Spindle service part set					



**C**

**C Inline toggle with angled base plate**

	Clamping Capacity	Automatic Adjust	Nominal Clamping Force Range	Holding Capacity	Approx. Weight	Fastener
<b>STC-IHA15</b>	3/8"	5/16"	25 - 250 lbs.*	450 lbs.	0.48 lbs.	3/16" or M5
<b>3101627</b>	STC-IHA15 Spindle service part set					



See Appendix page 81/82 for drawings and charts.

\* Variable and dependent on spindle settings, pressure screw setting, force applied etc. Some small spindle adjustments may be required to achieve maximum clamping opening. Note: All clamping force values in this catalog are approximate as applied force can vary based on spindle settings, pressure screw settings, force applied etc

## Self-adjusting toggle clamps

BESSEY® Auto-Adjust Toggle Clamps have changed the way toggle clamps are constructed with variable range clamping force and the ability to auto-adjust to variations in workpiece height while maintaining constant clamping force. Now workpieces of differing heights can be clamped quickly and securely – perfect for large and small-scale production situations. Performance flexibility offers advantages beyond traditional toggle clamps: safer operation, more consistent applied force and more flexible toolcribs.

### 1 Auto-adjustment of the jaw height

The BESSEY® Auto-Adjust Toggle Clamp self adjusts to variations in workpiece height while maintaining clamping force.

### 2 Adjustable clamping force

The integrated clamping force adjustment screw can vary the applied clamping force in a range.

### 3 Adaptable base plate

Holes are sized and spaced for easy mounting and flexibility in metric and imperial. Use ¼" (M6) for STC-VH50, STC-HH50, STC-HH70 and STC-IHH25; and ⅜" (M5) for the balance.

### 4 Large ergonomic handle

Large, heat resistant handles are designed with user comfort in mind. Soft inserts further reduce hand fatigue.

### 5 Corrosion resistance

Nickel plated coatings inhibit corrosion and extend tool life.

**BESSEY® Toggle Clamp Force Generation**

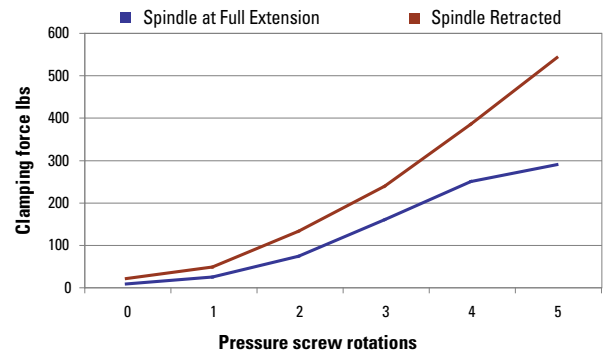

Clamping height: 30mm. Pressure screw set initially to lowest clamp force (0) then 1 full rotation for each measurement point.

## D Horizontal toggle with open arm and horizontal base plate

	Clamping Capacity	Automatic Adjust	Nominal Clamping Force Range	Holding Capacity	Approx. Weight	Fastener
<b>STC-HH20</b>	1 <sup>3</sup> / <sub>16</sub> "	3/4"	25 - 250 lbs.*	450 lbs.	0.43 lbs.	3/16" or M5
<b>STC-HH50</b>	1 9/16"	1 3/8"	25 - 550 lbs.*	700 lbs.	0.81 lbs.	1/4" or M6
<b>STC-HH70</b>	2 3/8"	1 3/8"	25 - 550 lbs.*	700 lbs.	1.00 lbs.	1/4" or M6
<b>3101627</b>	STC-HH20 Spindle service part set					
<b>3101589</b>	STC-HH50 Spindle service part set					
<b>3101588</b>	STC-HH70 Spindle service part set					



## E Horizontal toggle with vertical base plate

	Clamping Capacity	Automatic Adjust	Nominal Clamping Force Range	Holding Capacity	Approx. Weight	Fastener
<b>STC-HV20</b>	1 <sup>3</sup> / <sub>16</sub> "	3/4"	25 - 250 lbs.*	450 lbs.	0.45 lbs.	3/16" or M5
<b>3101627</b>	STC-HV20 Spindle service part set					



## F Horizontal toggle with angled base plate

	Clamping Capacity	Automatic Adjust	Nominal Clamping Force Range	Holding Capacity	Approx. Weight	Fastener
<b>STC-HA20</b>	1 <sup>3</sup> / <sub>16</sub> "	3/4"	25 - 250 lbs.*	450 lbs.	0.48 lbs.	3/16" or M5
<b>3101627</b>	STC-HA20 Spindle service part set					



See Appendix pages 77-78 for drawings and charts.

\* Variable and dependent on spindle settings, pressure screw setting, force applied etc. Some small spindle adjustments may be required to achieve maximum clamping opening. Note: All clamping force values in this catalog are approximate as applied force can vary based on spindle settings, pressure screw settings, force applied etc



# Clamping elements for multi function table



## Accessory for use on multifunction (MFT) tables

BESSEY® special adapters allow BESSEY® toggle clamps to be used on multifunction tables. The three-part accessory set can be assembled in a few simple steps. For this, a locking pin is attached via a cylinder screw under the base plate. Added in this way, the toggle clamp can be used directly in the multifunction table and secured from underneath with a large, easy to handle, knurled plastic knob.



## A Accessory for use on multifunction (MFT) tables

Works with matrix tables having 20 mm diameter holes (e.g. Festool MFT). Ideal for work surfaces 19 to 25 mm thick. Set includes: 1X cylindrical screw M8 x 35 mm; 1X lock pin 20 mm OD x 17 mm long; 1X knurled knob with M8 thread.



Use on BESSEY Auto Adjust toggle clamps with horizontal base plate: Horizontal toggle clamp STC-HH50 / -HH70; Push/pull clamp STC-IHH25; Vertical toggle clamp STC-VH50

STC-SET-T20 is a low cost optional accessory - clamps not included.

	Clamp Hole Diameter	Workbench Hole Diameter	Approx. Weight
<b>STC-SET-T20</b>	8.2 mm	20 mm	0.21 lbs



## T-Slot Table Application

The BESSEY self adjusting toggle clamps were modified to include an 8.2 mm hole in the horizontal base for different accessories. In this case, the main accessory is the STC-SET-T20 and it can be used on tables with a 20 mm hole (like MFT). That same 8.2 mm hole in the toggle clamp also allows it to be used with a T-slot table. Use an appropriately sized 8 mm fastener and a t-slot nut that fits your machine table or system and the application becomes very straightforward. T-slot fasteners not sold by BESSEY.

## RiteHite hold down products

A quick and easy set-up, ready for your T-slot table. A value-priced hold down alternative with the great BESSEY® quality you expect.

### 1 Single component design

Self-positioning, single component design for a quick set-up.

### 2 Workpieces of different thicknesses

Wide clamping range. Adjustments up to 5".

### 3 T-slot table ready

For T-slot hold down tables in machine shop applications.

### 4 Sturdy frame

Strong, ductile iron body, strength you can depend on.

### 5 Swivel rocker

Swivel rocker attached to body allows the clamp to self-align on the work piece.



### A RiteHite Long Reach, Model L

Use the BESSEY® RiteHite to hold your workpiece in place with the simple self-positioning, single component design. Its made of strong, ductile iron, for use on a T-slot hold down table in a machine shop. It even has a swivel rocker attached to the body to prevent loss. Use the L series for a longer throw.

	Bolt Size	Max Clamping Height	Nominal Dimensions	Clamping Force	Max Torque	Approx. Weight
375L	3/8"	1 1/4"	3 3/4 x 1 1/8 x 1 1/4	7,000 lbs	43 LB-FT	0.50 lbs
500L	1/2"	2 1/2"	5 3/4 x 1 7/16 x 1 1/2	8,800 lbs	73 LB-FT	1.39 lbs
625L	5/8"	3 1/2"	6 3/4 x 1 3/4 x 1 3/8	14,500 lbs	163 LB-FT	2.33 lbs
750L	3/4"	5"	9 x 2 1/8 x 2 1/4	19,000 lbs	237 LB-FT	4.96 lbs
1000L	1"	5"	11 1/8 x 2 7/8 x 3 3/8	51,000 lbs	850 LB-FT	12.80 lbs



### B RiteHite Standard Reach, Model S

The S series, slightly smaller than its counterpart but with the strength you can depend on.

	Bolt Size	Max Clamping Height	Nominal Dimensions	Clamping Force	Max Torque	Approx. Weight
376S	3/8"	1"	3 x 1 1/8 x 1 1/4	8,800 lbs	55 LB-FT	0.43 lbs
501S	1/2"	1 3/4"	4 1/4 x 1 7/16 x 1 1/2	13,200 lbs	110 LB-FT	1.04 lbs
626S	5/8"	2 3/4"	5 1/2 x 1 3/4 x 1 3/8	19,000 lbs	213 LB-FT	2.10 lbs
751S	3/4"	3 1/2"	7 x 2 1/8 x 2 1/4	27,600 lbs	345 LB-FT	4.00 lbs
1001S	1"	3"	9 x 2 7/8 x 3 3/8	67,000 lbs	1,116 LB-FT	10.00 lbs



RiteHite charts are for general guidelines only. Specific values may vary depending on but not limited to bolt size and strength, condition, size and pitch of threads, coefficient of friction between parts and other variable factors.

# Hold down clamps



## Hold down clamps

The BESSEY® table clamp offering has a variety of options available for challenging table clamping on a T-Slot table. The BSG clamp has a traditional bar clamp configuration while the BSN family of clamps have a lever handle with a ratcheting mechanism for controlled, fast and vibration proof clamping. Ideal for machines equipped with "T" slots. A cantilevered option keeps the handle behind the clamp's rail for minimal obstruction to the tool head while the BESSEY® FC24-8 clamp may be used in a variety of ways to accommodate your needs while clamping. Some great choices for challenging work applications



A

### A Hold down table clamps

Vibration proof, ratchet action for rapid clamping. Pressure pad self-adjusts on the workpiece. Drop forged steel clamping arm. Mounting hole accepts 5/8" bolts.



	Max Clamping Height	Throat Depth	Clamping Force	Rail Profile	Fixing Hole	Approx. Weight
<b>BS3N</b>	8"	4.75"	1200 lbs	0.87" x 0.41"	0.51"	3.42 lbs
<b>BS4N</b>	8"	4.75"	1650 lbs	1.10" x 0.43"	0.65"	5.84 lbs
<b>2400 HD-10</b>	9.5"	5.5"	2220 lbs	1.18" x 0.59"	0.65"	7.80 lbs
<b>BS6N</b>	20"	5.5"	2220 lbs	1.18" x 0.59"	0.65"	8.82 lbs



B

### B Hold down table clamps, BSG

For fastening to tables and other equipment. Long life due to heat-resistant pressure plate with sintered steel insert, which can be tilted up to 35°. Mounting hole accepts 5/8" bolts.



	Max Clamping Height	Throat Depth	Clamping Force	Rail Profile	Fixing Hole	Approx. Weight
<b>BSG21-14</b>	8.25"	5.5"	2650 lbs	1.18" x 0.59"	0.65"	7.10 lbs



### Table of dimensions

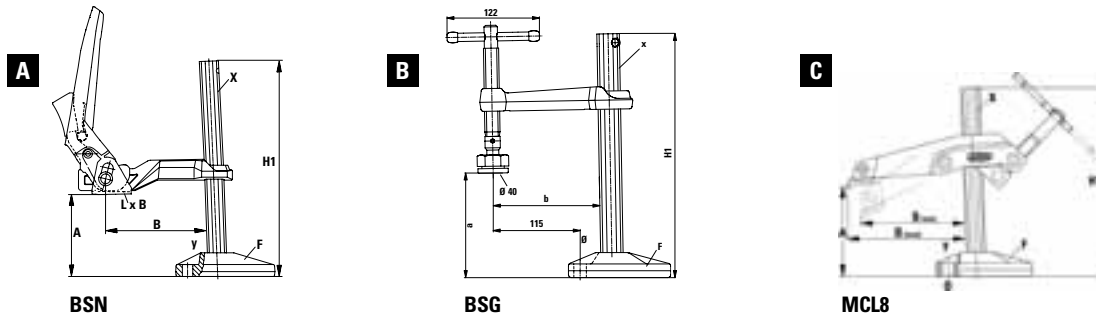

	Opening Max	Throat Depth	Base Height	Pressure Plate Dimensions	Foot Length	Foot Width	Foot Height	Foot Distance to the rail	Rail Profile	Fixing Hole	Clamping Force
	A	B	H1	L x B	F	F	F	F to Y	X	O	
BS3N	200mm/8.00"	120mm/4.75"	260mm/10.24"	42x25mm/1.65 x 0.98"	100mm/3.94"	38mm/1.50"	25mm/0.98"	32mm/1.26"	19.5x9.5mm/0.87x0.41"	10.5mm/0.51"	1200 lbs
BS4N	200mm/8.00"	120mm/4.75"	270mm/10.63"	48x31mm/1.89 x 1.22"	135mm/5.31"	49mm/1.93"	33mm/1.30"	42mm/1.65"	28x11mm/1.10 x 0.43"	16.5mm/0.65"	1650 lbs
2400HD-10	240mm/9.50"	140mm/5.50"	320mm/12.60"	48x31mm/1.89 x 1.22"	135mm/5.31"	49mm/1.93"	33mm/1.30"	42mm/1.65"	30x15mm/1.18 x 0.59"	16.5mm/0.65"	2220 lbs
BS6N	500mm/20.00"	140mm/5.50"	580mm/22.83"	48x31mm/1.89 x 1.22"	135mm/5.31"	49mm/1.93"	33mm/1.30"	42mm/1.65"	30x15mm/1.18 x 0.59"	16.5mm/0.65"	2220 lbs
BSG21-14	210mm/8.25"	140mm/5.50"	322mm/12.68"	Ø 40mm/1.57"	135mm/5.31"	48mm/1.89"	33mm/1.30"	42mm/1.65"	30x15mm/1.18 x 0.59"	16.5mm/0.65"	2650 lbs
MCL8	200mm/8.00"	123-140mm/ 4.84-5.50"	265mm/10.43"	25x35mm/0.98 x 1.38"	135mm/5.31"	48mm/1.89"	33mm/1.30"	42mm/1.65"	28x11mm/1.10 x 0.43"	16.5mm/0.65"	1450 lbs

Note: Clamping force calculated at a height of 2-3" on a solid all-steel welding table platform

#### C Claw machine clamp, MCL

A cantilever jaw for clamping in tight spaces with the screw positioned outside of work area. Use for drilling and light milling work. Full rotation outside of the work area. Mounting hole accepts 5/8" bolts.



	Max Clamping Height	Throat Depth	Clamping Force	Rail Profile	Fixing Hole	Approx. Weight
MCL8	8"	4.84"-5.5"	1450 lbs	1.10" x 0.43"	0.65"	6.74 lbs



#### D Jig & fixture clamp, FC

A full rotation of 360° for easy work-piece removal. The pressure plate swivels up to 35° and the bushing O/D is 1 13/16", and can fit a table thickness of 1/2" to 1 1/2". Bushing can be set to be freely rotating, fixed or quick release position by adjusting or removing bottom plate.



	Clamping Capacity	Throat Depth	Clamping Force	Approx. Weight
FC24-8 3100459	8"	5 1/2"	2660 lbs	6.45 lbs
		Inner/outer bushing set for FC24		



# BAS

## BAS machine table clamps

An incredibly compact design, both in height and surface, with a heavy duty clamping pressure, puts the BAS clamps above the competition. Try one for yourself!



### 1 Housing is heat-treated CrMo

The self-locking worm gear unit exerts up to 3600 lbs of clamping force.

### 2 Clamping arms with aluminum pressure pads

The short and long clamping arms are equipped with a swivelling aluminum pressure pad. A polyamide seal protects the interior against dirt.

### 3 Open or closed mounting holes

Clamp and unclamp quickly with open hole models. In closed versions, the screw, nut and clamp form a unit.

### 4 Space saving and adjustable

All BAS models feature a compact design in height and in surface. Clamping height can be increased with the BESSEY® BASO base unit, but care must be taken to provide precise workpiece contact surfaces.



## A BAS-C compact clamp

Space saving compact design with clamping force up to 3600 lbs.



Mounting hole open for M10 / M12 ( $\frac{3}{8}$  /  $\frac{7}{16}$ ).

	Opening Max.	Throat Depth	Clamping Force	Clamping Arm Length
<b>BAS-C9-4</b> 3101428	88 mm/3.46"	40 mm/1.57"	3600 lbs.	75 mm/2.95"
<b>BAS-C10-6</b> 3101429	97 mm/3.82"	60 mm/2.36"	2700 lbs.	94 mm/3.70"

Mounting hole closed for M10 / M12 ( $\frac{3}{8}$  /  $\frac{7}{16}$ ).

<b>BAS-CB9-4</b> 3101428	88 mm/3.46"	40 mm/1.57"	3600 lbs.	75 mm/2.95"
<b>BAS-CB10-6</b> 3101429	97 mm/3.82"	60 mm/2.36"	2700 lbs.	94 mm/3.70"



## B Base unit, BASO

Need more height? The BASO base unit adds an extra 80 mm. Stackable to 10 units. Suitable for all BESSEY BAS clamps. Mounting hole open for M10 / M12 ( $\frac{3}{8}$  /  $\frac{7}{16}$ ), and includes socket head screw.



Mounting hole open

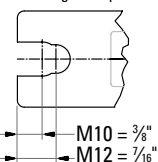

	Opening Max.	Fastening Thread
<b>BASO</b>	80 mm/3.15"	M10

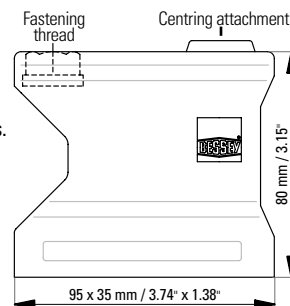

## C Service Part

3101431

BAS Arm Tip, set of 4

# Workbench adapter

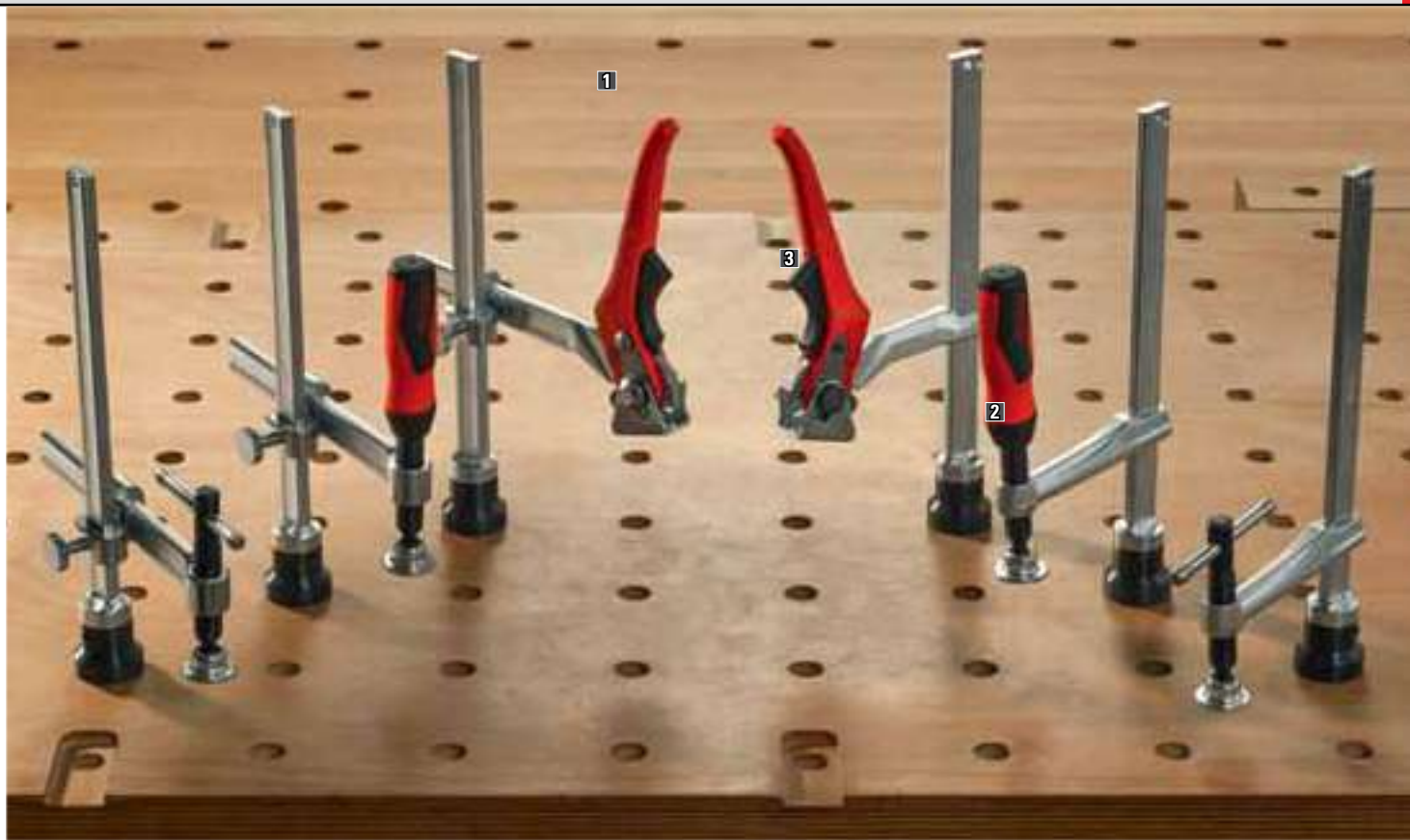

## Accessory for workbenches

BESSEY® provides solutions for fixing workpieces to workbenches. Use the TWV and TW clamping elements in conjunction with one of the workbench adapters on a workbench.

### 1 NEW adapters for workbenches

BESSEY® TWV and TW clamping elements with a 16 mm hole system (see page 37-38) can be used on wooden workbenches using an easy-to-use adapter. Put the 16mm TW/TWV clamp into the adapter and place into the table hole. See chart below for configurations.

### 2 Flexible or fixed throat depth

Adjustable throat depth (TWV) and fixed throat depth (TW) are available in 3 handle variants.

### 3 Handle variants

The ratchet mechanism ensures rapid, controlled, vibration-free clamping. The T-Bar versions and more traditional 2K handle offer excellent options for the end user.



### A Workbench adapter, 16 mm

Accessories for BESSEY® TWV and TW clamping elements with 16 mm hole system. Suitable for common workbenches with a hole system (see below). Can be used without tools. The stud pin can be changed to use other hole systems.

	Clamp Hole Diameter	Workbench Hole Diameter	Approx. Weight
<b>TW16AW19</b>	16 mm	3/4"	0.82 lbs
<b>TW16AW20</b>	16 mm	25/32"	0.85 lbs
<b>TW16AW25</b>	16 mm	1"	0.90 lbs
<b>TW16AW30</b>	16 mm	1 1/4"	0.95 lbs

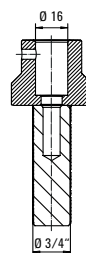



# Welding table clamps



### A Welding table clamp, variable throat depth, TWV

Precise, individual clamping with variable height and adjustable throat depth. Tempered profile rail and sliding arm for strong, dependable clamping.

Available with: high quality 2-component plastic handle; T-Bar with rounded ends (each with smooth-running ACME threaded spindle and tool free pressure plate replacement); or lever handle with a ratcheting mechanism for controlled, fast and vibration-proof clamping.

	Handle Style	Hole Diameter	Clamping Capacity	Nominal Throat Depth	Rail Profile	Clamping Force	Approx. Weight
<b>TWV16-20-15-2K</b>	Composite	16 mm	8"	1 3/16" - 6"	7/8" - 3/8"	550 lbs	2.50 lbs
<b>TWV16-20-15K</b>	T-Bar	16 mm	8"	1 3/16" - 6"	7/8" - 3/8"	550 lbs	2.34 lbs
<b>TWV16-20-15H</b>	Lever	16 mm	8"	2 3/8" - 6"	7/8" - 3/8"	550 lbs	2.72 lbs
<b>TWV28-30-17-2K</b>	Composite	28 mm	12"	1 3/16" - 6 3/8"	1 1/8" - 7/16"	1100 lbs	4.89 lbs
<b>TWV28-30-17K</b>	T-Bar	28 mm	12"	1 3/16" - 6 7/8"	1 1/8" - 7/16"	1100 lbs	4.65 lbs
<b>TWV28-30-17H</b>	Lever	28 mm	12"	4 3/16" - 6 7/8"	1 1/8" - 7/16"	1100 lbs	5.47 lbs

Note: Clamping force calculated at a height of 2-3 In on a solid all-steel welding table platform



## Bringing our experience to the table

Clamping elements for welding tables with 28 mm or 16 mm matrix holes. Choose from 3 handle designs for standard elements, plus variable or fixed throat depth versions. Our line-up also includes a clamping element with heat-resistant pressure plate, a gripping arm variant for easy work area access, and attachments for clamping oval, round and square workpieces.

All elements can integrate into the table without using tools, making them highly adaptable with comfortable, safe and precise operation. Try them for yourself!

### 1 Flexible throat depth

The BESSEY® TWV28 has an adjustable throat depth.

### 2 Choice of handles and throat depths

The BESSEY® TW elements feature 3 handle variants and 3 throat-depth variants.

### 3 Heavy-duty, custom design

TWM28 with heat-resistant special pressure plate and sintered steel insert, can pivot up to 35°.

TW28GRS gripping arm features a spindle located outside the work area. For hard to reach clamping.

### 4 Flexible accessories

TW28VAD and TWWAD vario table clamping attachments are ideal for irregularly shaped workpieces. They are infinitely adjustable to the workpiece being welded, from 60° internal to 60° external.

### 5 Quick conversion of existing table clamps for welding table use

Convert existing BESSEY® machine table clamps by screwing the TW28H0 attachment into the hole on the bottom of the machine table clamp for use on matrix tables.



## B Welding table clamp, fixed throat depth TW

Precise, individual clamping with variable height and fixed throat depth. Tempered profile and sliding arm for strong, dependable, clamping.

Available with: high quality 2-component plastic handle; T-Bar with rounded ends (each with smooth-running ACME threaded spindle and tool free pressure plate replacement); or lever handle with a ratcheting mechanism for controlled, fast and vibration-proof clamping.

	Handle Style	Hole Diameter	Clamping Capacity	Nominal Throat Depth	Rail Profile	Clamping Force	Approx. Weight
TW16-20-10-2K	Composite	16 mm	8"	4"	3/8" - 3/8"	650 lbs	2.06 lbs
TW16-20-10K	T-Bar	16 mm	8"	4"	3/8" - 3/8"	650 lbs	1.91 lbs
TW16-20-10H	Lever	16 mm	8"	4"	3/8" - 3/8"	650 lbs	2.22 lbs
TW28-30-12-2K	Composite	28 mm	12"	4 3/4"	1 1/8" - 7/16"	1000 lbs	3.70 lbs
TW28-30-14-2K	Composite	28 mm	12"	5 1/2"	1 1/8" - 7/16"	1100 lbs	3.75 lbs
TW28-30-12K	T-Bar	28 mm	12"	4 3/4"	1 1/8" - 7/16"	1000 lbs	3.57 lbs
TW28-30-14K	T-Bar	28 mm	12"	5 1/2"	1 1/8" - 7/16"	1100 lbs	3.64 lbs
TW28-30-12H	Lever	28 mm	12"	4 3/4"	1 1/8" - 7/16"	1000 lbs	4.56 lbs
TW28-30-14H	Lever	28 mm	12"	5 1/2"	1 1/8" - 7/16"	1100 lbs	4.63 lbs

Note: Clamping force calculated at a height of 2-3 in on a solid all-steel welding table platform





# Welding table clamps



### C Welding table clamp with MorPad, TWM28

Tempered profiled rail and drop forged sliding arm for strength where it is most needed. Tempered spindle – particularly sturdy and wear-resistant – for noticeably improved service life. Long life due to heat-resistant MorPad with sintered steel insert, which can be tilted up to 35°.

	Hole Diameter	Clamping Capacity	Nominal Throat Depth	Rail Profile	Clamping Force	Approx. Weight
<b>TWM28-30-12</b>	28mm	12"	4 3/4"	1 1/8" - 7/16"	1400 lbs	3.92 lbs

Note: Clamping force calculated at a height of 2-3 In, on a solid all-steel welding table platform, with heavy duty MorPad.



### D Welding table clamp, TW28GRS

The spindle is located on the outside for free access to the work area and to protect against welding spatter. Special, sturdy V-grooved pressure plate, ideal even for clamping round or square workpieces. Pivotal and infinitely adjustable in terms of height. Particularly suited to clamping with the tightest of space constraints, in narrow openings as well as for short projections.

	Hole Diameter	Clamping Capacity	Nominal Throat Depth	Rail Profile	Clamping Force	Approx. Weight
<b>TW28GRS30-12</b>	28mm	12"	4 3/4"	1 1/8" - 7/16"	1100 lbs	5.13 lbs

Note: Clamping force calculated at a height of 2-3 In on a solid all-steel welding table platform

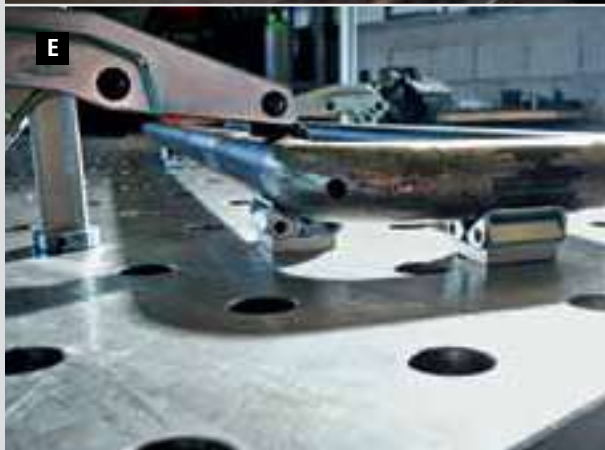

TW16VAD/  
TW28VAD



TWVAD

### E Welding table clamp accessories, TWVAD

Specifically adapted to round, oval and square workpieces. Angle infinitely adjustable from 60° internal to 60° external. TW16VAD / TW28VAD version – with bolt for rapidly aligning and fixing the workpiece to the welding table. TWVAD version – without bolt for variable movement on the welding table. 2 pieces per bag.

	Hole Diameter	Angle	Jaw Face Width	Approx. Weight
<b>TW16VAD</b>	16 mm	from 60° inner to 60° outer	1 1/16"	0.82 lbs
<b>TW28VAD</b>	28 mm	from 60° inner to 60° outer	1 1/16"	1.24 lbs
<b>TWVAD</b>	–	from 60° inner to 60° outer	1 1/16"	0.62 lbs



### F Welding table toggle clamp adapter, TW-STC

Accessory for BESSEY® STC toggle clamp with horizontal base plate. With bolt – for use directly on the welding table. Without bolt – for screwing to the extension TWX.

	Hole Diameter		Approx. Weight
<b>TW16A-STC</b>	16 mm	STC-VH / STC-HH / STC-IHH	0.39 lbs
<b>TW28A-STC</b>	28 mm		0.62 lbs



### G Welding table clamp extension, TWX

Accessory for BESSEY® toggle clamp adapter TW28A-STC and TWVAD. Lowering of round workpieces is infinitely adjustable using the adjusting ring in the round plate. Use with TWVAD – requires one 8 x 40 mm flat head screw.

	Hole Diameter	Suitable for	Adjusting Range	Approx. Weight
<b>TW16X</b>	16 mm	TW16A-STC / TW16VAD / TWVAD	5/8" - 7 7/8"	0.93 lbs
<b>TW28X</b>	28 mm	TW28A-STC / TW28VAD / TWVAD	5/8" - 11 13/16"	3.88 lbs



### H Welding table clamp tilting adapter, TW28AV

Accessory for BESSEY® extension TW28X. Pivoting spindles with stepless adjustment from -52° to +52°. Lockable trapezoidal nut for secure fastening of the workpiece. High quality, 2-component plastic grip with 6 7/8" long spindle.

	Hole Diameter	Max Clamping Height	Suitable for	Approx. Weight
<b>TW28AV</b>	28 mm	6 7/8"	TW28X	2.25 lbs



### I Welding table clamp attachment, TW28HO

Accessory for BESSEY® work table clamp. It can be used on matrix welding tables by simply screwing it to the work table clamp.

	Hole Diameter	Suitable for	Approx. Weight
<b>TW28HO</b>	28 mm	BAS-C / BAS-CB / BASO / BSN / GRS / BSG	0.31 lbs



### J BESSEY® clamp service part, MorPads

Long life due to heat-resistant pressure plate with sintered steel insert, which can tilt up to 35°. Three design versions: smooth face (standard version); rough face for secure clamping on dirty surfaces; V-groove face for round, oval and edged workpieces.

- 3100736** Smooth face (standard)
- 3101192** Rough face
- 3101193** V Groove



Ball-in-socket technology for greatly extended clamp life and, at full pressure... by BESSEY®. Patented.



One handed, light duty & clutch style clamps

# Clutch style bar clamps



## Clutch style bar clamp

The BESSEY® clutch style clamps are a popular regular duty clamp that can be used for a wide range of projects. These economical clamps are available in a wide range of sizes starting with the GSCC2.506 with a 2 ½" throat x 6" capacity up to the GSCC5.024 with a 5" throat x 24" capacity and, a range of clamping force from 600 to 1200 Lbs.

- 1 Cast iron jaws**  
Durable powder coated cast-iron fixed and sliding jaws.
- 2 Safety by design**  
Nickel plated, drawn and serrated rail.
- 3 Secure**  
2 piece slip-clutch plates keep the jaw sturdy and in place.
- 4 Protective pads**  
Non-marring pads on the top and bottom jaws.
- 5 Ergonomic wood handle or 2K handle**  
Ergonomically shaped, standard wood handle, or 2K comfort handle now available in the most popular GSCC3.5XX models.



### A Clutch style GSCC, with wooden handle

2 Piece slip-clutch plates keep the sturdy jaw in place. These easy-to-use clamps are suitable for "close quarters" clamping with the tried-and-true wood handle.

	Clamping Capacity	Throat Depth	Clamping Force	Approx. Weight
<b>GSCC2.506</b>	6"	2 ½"	600 lbs	1.34 lbs
<b>GSCC2.512</b>	12"	2 ½"	600 lbs	1.72 lbs
<b>GSCC2.518</b>	18"	2 ½"	600 lbs	1.97 lbs
<b>GSCC2.524</b>	24"	2 ½"	600 lbs	2.27 lbs
<b>GSCC2.530</b>	30"	2 ½"	600 lbs	2.57 lbs
<b>GSCC2.536</b>	36"	2 ½"	600 lbs	2.82 lbs
<b>GSCC2.5-PADS</b>	Replacement pads: contains 2 sets of pads/set			



### B Clutch style GSCC, with wooden handle

All the same great features, in a broader range of clamping sizes and force with the tried-and-true wood handle.

	Clamping Capacity	Throat Depth	Clamping Force	Approx. Weight
<b>GSCC3.506</b>	6"	3 ½"	1100 lbs	2.34 lbs
<b>GSCC3.512</b>	12"	3 ½"	1100 lbs	2.82 lbs
<b>GSCC3.518</b>	18"	3 ½"	1100 lbs	3.37 lbs
<b>GSCC3.524</b>	24"	3 ½"	1100 lbs	3.73 lbs
<b>GSCC3.530</b>	30"	3 ½"	1100 lbs	4.16 lbs
<b>GSCC3.536</b>	36"	3 ½"	1100 lbs	4.50 lbs
<b>GSCC5.012</b>	12"	5"	1200 lbs	4.54 lbs
<b>GSCC5.018</b>	18"	5"	1200 lbs	5.19 lbs
<b>GSCC5.024</b>	24"	5"	1200 lbs	5.94 lbs
<b>GSCC3.5-PADS</b>	Replacement pads: contains 2 sets of pads/set			

**C Clutch style GSCC, with 2K handle**

2 Piece slip-clutch plates keep the jaw sturdy and in place. These easy-to-use clamps are suitable for "close quarters" clamping with the 2K comfort handle.

	Clamping Capacity	Throat Depth	Clamping Force	Approx. Weight
<b>GSCC3.5 06+2K</b>	6"	3 1/2"	1100 lbs	2.34 lbs
<b>GSCC3.512+2K</b>	12"	3 1/2"	1100 lbs	2.82 lbs
<b>GSCC3.518+2K</b>	18"	3 1/2"	1100 lbs	3.37 lbs
<b>GSCC3.524+2K</b>	24"	3 1/2"	1100 lbs	3.73 lbs
<b>GSCC3.530+2K</b>	30"	3 1/2"	1100 lbs	4.16 lbs
<b>GSCC3.536+2K</b>	36"	3 1/2"	1100 lbs	4.50 lbs
<b>GSCC3.5-PADS</b>	Replacement pad set			



**D Clutch style GSCC, set of 4**

This special 4-Pack is a great way to expand your clamp collection, as you can never have too many clamps. Each 4 piece package contains 2 each of the 6 in. GSCC2.506 and 12 in. GSCC2.512 clamp. The BESSEY® clutch style clamps are a popular and economical clamp that can be used for a wide range of woodworking and DIY projects. There are many other clamps available in the GSCC series ranging in size from 6 in. to 36 in., clamping capacity. Clamps with a deeper 3.5 in. and 5 in. throat depth are also available.

	Throat Depth	Clamping Force	Approx. Weight
<b>GSCC4PK</b>	2 1/2"	600 lbs	6.25 lbs
<b>GSCC2.5-PADS</b>	Replacement pad set		



**E Clutch style DHBC, with double jaw**

The double jaw on these BESSEY® clutch style clamps give them versatility & allow them to do many jobs that other clamps just cannot do. BESSEY's double jaw design allows these clamps to disperse the pressure more evenly, making them ideal for delicate work. The powder coated, ductile cast iron jaws & two piece non-slip clutch make these clamps durable, tough & ensure you will get a strong hold.

	Clamping Capacity	Throat Depth	Clamping Force	Approx. Weight
<b>DHBC-12</b>	12"	3 1/2"	400 lbs	2.28 lbs
<b>DHBC-24</b>	24"	3 1/2"	400 lbs	2.88 lbs
<b>DHBC-36</b>	36"	3 1/2"	400 lbs	3.48 lbs



Find Double head (DHCC) C-clamps on page 46



# Strap clamps

## Clamp any shape

Clamping large or odd shapes with straps is not new; however, most strap clamps exert force (pull) in only one direction which can easily distort/skew the work piece. BESSEY®'s VAS-23 is different, it pulls equally on both ends of the strap, eliminating the chance of skewing your work piece to one side. The high tensile woven polyester strap is extremely strong with a built-in take up reel that neatly stores the excess strap; eliminating a potential tripping hazard.



### 1 Strap is drawn in on both sides

The strap draws simultaneously from both sides ensuring pressure is applied equally on all corners without distortion.

### 2 Integrated coiling mechanisms

Integrated rewind mechanism is operated with a crank handle which eliminates tangling and damage to the strap.

### 3 Practical Vario corners

Vario clip corners with twin-tilting pressure pads auto-adjust from 60° to 180° for easy assembly of most multi-angle projects.

### 4 Extremely resistant

The special woven polyester band provides high resistance to tearing, and a clamping range of 23 ft. The steel wire loop opens quickly and simply to adjust or release glue-up.

### 5 BESSEY comfort handle

The 2K composite handle with comfort insert comes standard.



### A Variable angle strap clamp with 2K composite handle, VAS

High quality strap clamp places even pressure on mitre joints. Applies a positive, even pressure on all joints, perfect for clamping square, round, rectangular or irregular shapes. Comes with 4 pivoting Vario corners.

	Clamping Capacity	Range of Angle	Approx. Weight
VAS-23+2K	Up to 23 feet	60° to 180°	1.27 lbs



### B Variable angle strap clamp with 2K composite handle, VAS

High strength strap clamp places even pressure on all corners. Applies a positive, even pressure on all joints, perfect for clamping round or irregular shaped objects. Comes with 3 movable corner guides, high strength strap, and ergonomic 2 component handle.

	Clamping Capacity	Approx. Weight
VAS400	Up to 12 feet	1.06 lbs



### C Vario corner clips, VAC

With twin-tilting pressure pads the vario corner clips are a great accessory to the Variable Angle Clamp (VAS-23). The corner clips auto adjust to pressure with a range of angle of 60° to 180°.

	Package Includes	Range of Angle	Approx. Weight
VAC-6	6 corner clips per package	60° to 180°	0.26 lbs



# C-clamps

## C-clamps

C-clamps are used for many trades and if you're going to use a C-clamp why not use the best... BESSEY® has a wide variety of C-clamps to choose from, ranging from light duty to heavy service.

The heaviest & strongest of the drop-forged "C" clamps are the B-HS series. The BESSEY® Heavy Service series of clamps are sometimes referred to as "bridge clamps". These are made for the heaviest of steel construction & fabrication projects. Heavy square head on end of spindle designed to be used with wrenches & power tools - they do not have sliding pin T-handles like lesser clamps.

**1 Drop forged**

For a longer lasting tool.

**2 Square head for maximum torque**

**3 Heat-treated frames**

Designed for heavy industrial and construction applications.

**4 Clamping force**

Clamping forces up to 40,000 lbs



**A Heavy service HS series (fully closing)**

The toughest of the C-clamps with a clamping pressure of up to 40,000 lbs. Square head on the spindle.

	Clamping Capacity	Throat Depth	Clamping Force	Approx. Weight
<b>B-HS0</b>	0-3/4"	1 1/16"	2,800 lbs	0.33 lbs
<b>B-HS1</b>	0-1 3/8"	1 3/32"	5,600 lbs	1.00 lbs
<b>B-HS1.5</b>	0-1 3/4"	1 7/16"	8,750 lbs	1.80 lbs
<b>B-HS2</b>	0-2 3/8"	1 7/8"	12,500 lbs	4.50 lbs
<b>B-HS3</b>	0-3 5/16"	2 5/16"	16,250 lbs	7.10 lbs
<b>B-HS4</b>	0-4 1/2"	2 3/4"	20,000 lbs	11.00 lbs
<b>B-HS5</b>	0-5 1/4"	3 1/16"	23,800 lbs	14.90 lbs
<b>B-HS6</b>	0-6 3/8"	3 3/8"	27,500 lbs	19.30 lbs
<b>B-HS8</b>	0-8 1/4"	3 5/8"	31,250 lbs	27.50 lbs
<b>B-HS10</b>	0-10 1/4"	3 15/16"	35,000 lbs	40.10 lbs
<b>B-HS12</b>	0-12 3/8"	4 1/4"	40,000 lbs	47.80 lbs



**B Heavy duty 100 series C-clamps**

The 100 series of drop-forged "C" clamps are made in the USA & have been carefully engineered for greater strength than the CDF series are ideal for heavy industrial & construction applications. These clamps have sliding pin T-handle as well as a square head for maximum torque & flexibility.

	Clamping Capacity	Throat Depth	Clamping Force	Approx. Weight
<b>B-102</b>	0-2"	1 1/2"	7,500 lbs	1.50 lbs
<b>B-103</b>	0-3"	2"	8,750 lbs	2.65 lbs
<b>B-104</b>	0-3 1/2"	2 1/4"	10,000 lbs	4.15 lbs
<b>B-106</b>	2-5 1/2"	2 1/2"	11,250 lbs	6.00 lbs
<b>B-108</b>	4-7 1/2"	2 5/8"	12,500 lbs	7.80 lbs
<b>B-110</b>	6-9 1/2"	2 3/4"	13,750 lbs	8.70 lbs
<b>B-112</b>	8-11 1/2"	2 7/8"	15,000 lbs	12.10 lbs



# C-clamps

C



## C Regular duty CDF, deep throat C-clamps

The CDF series "C" clamps have heavy-duty drop-forged, heat-treated frames with a black powder coat finish, the handle, spindle and pressure pad assemblies have a black oxide finish.



	Clamping Capacity	Throat Depth	Clamping Force	Approx. Weight
<b>CDF402</b>	0-2"	2 1/8"	3,500 lbs	1.40 lbs
<b>CDF403</b>	0-3"	2 3/8"	3,500 lbs	1.90 lbs
<b>CDF404</b>	0-4"	3 1/4"	6,200 lbs	3.50 lbs
<b>CDF406</b>	0-6"	4 1/8"	6,900 lbs	5.40 lbs
<b>CDF408</b>	0-8"	5"	6,900 lbs	7.90 lbs
<b>CDF410</b>	0-10"	6"	8,000 lbs	11.60 lbs
<b>CDF412</b>	0-12"	6 1/4"	9,300 lbs	14.10 lbs

D



## D Regular duty CDFCHV, deep throat C-clamps – HiVis

The CDF400CHV series "C" clamps have heavy-duty drop-forged, heat-treated frames with a high visibility yellow powder coat finish, the handle, spindle & pressure pad assemblies are copper plated to resist weld spatter.



	Clamping Capacity	Throat Depth	Clamping Force	Approx. Weight
<b>CDF402CHV</b>	0-2"	2 1/8"	3,500 lbs	1.40 lbs
<b>CDF403CHV</b>	0-3"	2 3/8"	3,500 lbs	1.90 lbs
<b>CDF404CHV</b>	0-4"	3 1/4"	6,200 lbs	3.50 lbs
<b>CDF406CHV</b>	0-6"	4 1/8"	6,900 lbs	5.40 lbs
<b>CDF408CHV</b>	0-8"	5"	6,900 lbs	7.90 lbs
<b>CDF410CHV</b>	0-10"	6"	8,000 lbs	11.60 lbs
<b>CDF412CHV</b>	0-12"	6 1/4"	9,300 lbs	14.10 lbs

E



## E 540 series ductile alloy C-clamps

Cast ductile iron frame has approximately twice the tensile strength of similarly capacity clamps made of malleable cast iron. This clamp recommended for lighter duty, such as light assembly, sheet metal fabrication, woodworking, auto repair etc.



	Clamping Capacity	Throat Depth	Clamping Force	Approx. Weight
<b>540-2 1/2</b>	0-2 1/2"	1 3/4"	1100 lbs	1.20 lbs
<b>540-3</b>	0-3"	1 7/8"	1800 lbs	1.60 lbs
<b>540-4</b>	0-4"	2 1/16"	2150 lbs	2.23 lbs
<b>540-5</b>	0-5"	2 1/2"	2250 lbs	2.69 lbs
<b>540-6</b>	0-6"	2 3/4"	2450 lbs	3.20 lbs
<b>540-8</b>	0-8"	3 1/4"	2750 lbs	4.74 lbs
<b>540-10</b>	0-10"	3 5/8"	2850 lbs	7.56 lbs
<b>540-12</b>	0-12"	3 5/8"	2850 lbs	8.18 lbs
<b>540-14</b>	0-14"	3 3/4"	2850 lbs	8.93 lbs



### F Light duty drop forged C-clamps

The BESSEY® CM series light duty, drop forged C-Clamps are economical, yet sturdy. These clamps are great for light duty welding & fabrication work, as well as many jobs around the home workshop. A galvanized finish for models CM10-CM30, and a black powder coated finish for models CM40-CM80.

	Clamping Capacity	Throat Depth	Clamping Force	Approx. Weight
CM34DR	0-2 3/4"	4 1/2"	900 lbs	1.50 lbs
CM10	0-1"	1"	750 lbs	0.25 lbs
CM15	0-1 1/2"	1 1/2"	750 lbs	0.30 lbs
CM20	0-1 7/8"	1 1/2"	750 lbs	0.40 lbs
CM22	0-2 1/2"	1 3/8"	900 lbs	0.48 lbs
CM25	0-2 1/2"	2 1/2"	900 lbs	0.82 lbs
CM30	0-2 7/8"	1 3/4"	1,200 lbs	0.92 lbs
CM40	0-4"	3"	1,300 lbs	1.50 lbs
CM50	0-5"	3"	1,300 lbs	2.25 lbs
CM60	0-6"	3"	1,800 lbs	2.40 lbs
CM80	0-8 1/4"	4"	1,800 lbs	3.30 lbs



### G Quick release QRCC, C-clamps

The BESSEY® Quick Release C-Clamps have a drop forged frame with a powder coated finish. Spindle & pressure pad are chrome plated. A press of the red quick-release button allows for rapid fitting, to work piece when not under pressure - do not use to release a tool that is under pressure, as this will cause the quick release mechanism to wear out prematurely. Great for light duty, highly repetitive assembly work.

	Clamping Capacity	Throat Depth	Clamping Force	Approx. Weight
QRCC3	0-3 1/4"	1 3/4"	1,200 lbs	1.87 lbs
QRCC4	0-4 3/8"	2 1/4"	1,200 lbs	2.37 lbs
QRCC6	0-6 5/8"	3 7/8"	1,200 lbs	4.07 lbs



### H Double head DHCC, C-clamps

Provides twin top pressure points for light duty clamping applications. The ideal tool for hobbies, crafts and light trades.

	Clamping Capacity	Throat Depth	Clamping Force	Approx. Weight
DHCC-4	0-4"	2 1/4"	1,200 lbs	1.60 lbs
DHCC-6	0-6"	2 7/8"	1,200 lbs	3.00 lbs



# SuperGrips™

## SuperGrips™ grip pliers

Lock it into place with a BESSEY® SuperGrip™ plier. Let the clamp do the holding while you do the work. Adjustable in so many ways, a must have in your shop!

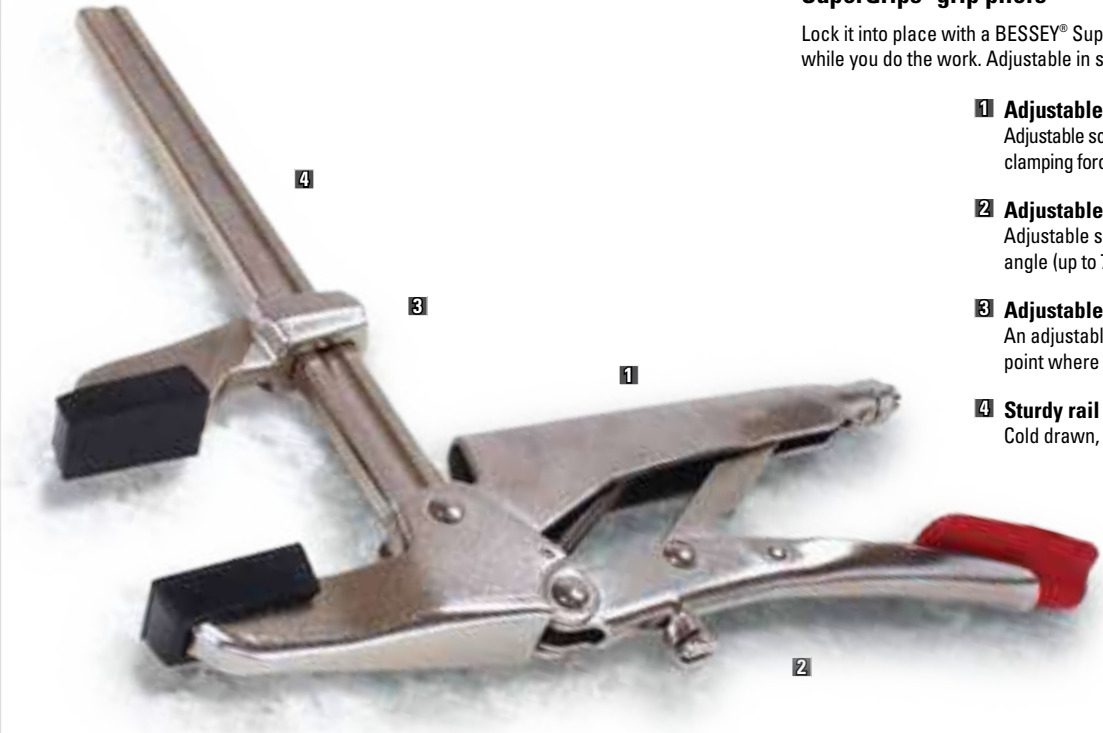

### 1 Adjustable top handle

Adjustable screw/lock nut (on top handle) adjusts clamping force.

### 2 Adjustable bottom handle

Adjustable screw/lock nut (on lower lever) adjusts jaw angle (up to 7°) for clamping tapered parts.

### 3 Adjustable sliding arm

An adjustable jaw for more precise clamping at the point where you need it.

### 4 Sturdy rail

Cold drawn, profiled steel rail.



### A SuperGrips™ with profiled rail, SG

It's a grip plier and clamp all in one tool, just a quick adjustment for a fast and easy set-up.

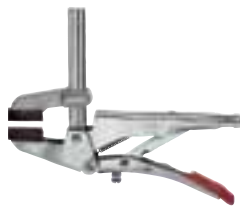

	Clamping Capacity	Throat Depth	Clamping Force	Approx. Weight
<b>SG4</b>	4"	2 ½"	440 lbs	2.43 lbs
<b>SG8</b>	8"	2 ½"	440 lbs	2.60 lbs
<b>3100576</b> (pair)		Replaceable pads		0.10 lbs



### B SuperGrips™ pipe clamp, SG

The innovative shape of the cradle jaw aligns and holds pipe firmly in place.



	Clamping Capacity	Throat Depth	Clamping Force	Approx. Weight
<b>SG24-PC</b>	4 ½"	2 ¾"	310 lbs	2.60 lbs
<b>3101547</b> (pair)		Replaceable pads		0.10 lbs



### C SuperGrips™ deep reach clamp

The deep reach jaws can easily clamp over angle iron, channel iron and other obstacles.



	Clamping Capacity	Throat Depth	Clamping Force	Approx. Weight
<b>SG5-DR</b>	4 ½"	3"	310 lbs	2.43 lbs

# Edge clamps

## Install edging in a snap

BESSEY® has applied its quality engineering and manufacturing to its edge clamps and made the woodworkers life a little easier. A range of edge clamping options provided to match the job and the budget. The quality you can expect only from BESSEY.

### 1 Unique twin spindle

Outer spindle acts on the clamping jaws – inner spindle applies pressure to the front edge. Impact resistant plastic handle for one-handed use.

### 2 Large jaws

Two large non-slip, opposing, gentle jaws for positive grip. The jaws have a non-slip plastic coating for a solid grip.

### 3 Swivel pressure plate

The large pressure plate serves to set the edge as the handle is tightened and the jaws engage. Removable protective cap.

### 4 Light aluminum housing

Lightweight, corrosion-resistant aluminum housing designed for high static stress load for convenient, one-handed edge clamp EKT.



## A One hand edge clamp, EKT

Lightweight construction makes EKT the perfect tool to secure edge banding with just one hand; improves productivity!

	Clamping Capacity	Throat Depth	Clamping Force	Approx. Weight
<b>EKT-55</b>	2 1/8"	3"	500 lbs	1.85 lbs
<b>3101403</b>	EKT pads (2)			
<b>3100998</b>	Gripping arm assemblies for EKT-55 (2)			

## B Edge clamp, KF2-4

For a quick one hand operation. Non-slip rubber lining for a sure grip.

	Clamping Capacity	Throat Depth	Approx. Weight
<b>KF2</b>	3/8" - 1 3/16"	3"	1.75 lbs
<b>KF4</b>	3/8" - 3 1/8"	4 1/4"	3.75 lbs
<b>4102100</b>	KF2 pads (2)		
<b>4102056</b>	KF4 pads (2)		

## C Light duty 3-way edge clamp, EC

The simplest in design, the 3-way edge clamp is lightweight and perfect for those basic edging projects. Adjustable three ways.

	Clamping Capacity	Throat Depth	Clamping Force	Approx. Weight
<b>B-EC3</b>	2 1/2"	2 1/2"	300 lbs	0.95 lbs

## D Spindle clamps

Can be used with a bar clamp with rails up to a 1/2" thick. Now you can do your glue-ups and apply the edge banding at the same time.

	Description	Approx. Weight
<b>KT5-1CP</b>	1 spindle	0.95 lbs
<b>KT5-2</b>	2 spindles	1.30 lbs





# Seaming tools

## Seaming tools

The BESSEY® solid surface seaming tool's twin vacuum cups secure the clamp to any smooth hard surface like polished granite, marble, Corian® and other man made non-porous counter top materials. Large diameter Acme type lead screw smoothly pull the to work pieces together. A great time saver.

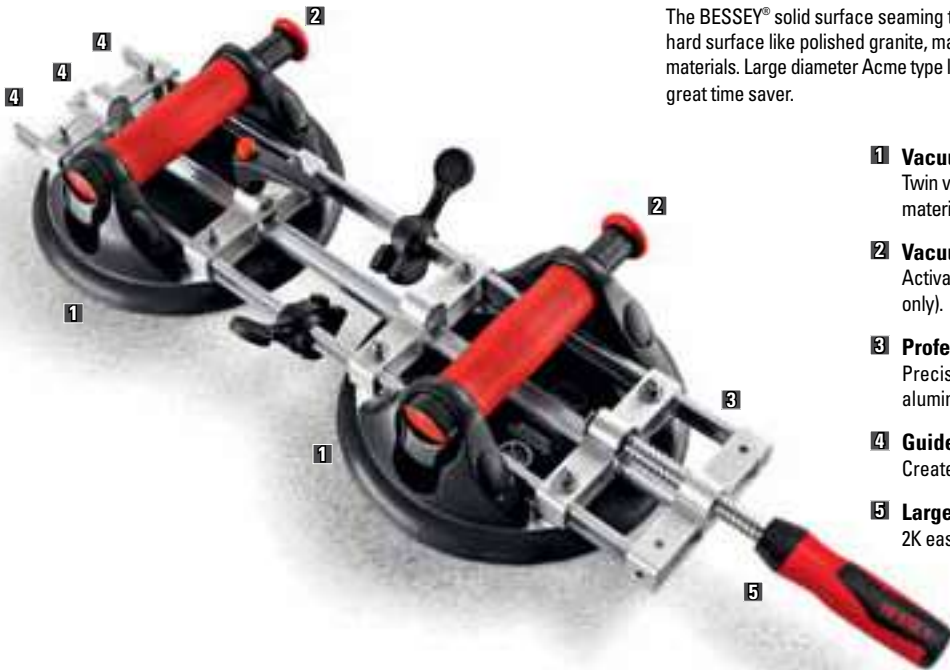

### 1 Vacuum cups

Twin vacuum cups secure the PS units to any smooth, non-porous material or solid surface like granite, marble, corian, plastic or glass.

### 2 Vacuum operating button

Activates & locks the vacuum seal on the work surface, (PS130 only).

### 3 Professional Tool

Precision, professional tool with work hardened spindle, aluminum frame and cold drawn rod guides.

### 4 Guide rails

Create a solid, rigid frame for supporting vacuum cups.

### 5 Large, comfortable ergonomic handles

2K easy grip handle for the PS130 and wooden handle on the PS55.



### A Extra large solid surface seaming tool, PS

Twin vacuum cups for clamping non-porous, solid surface material such as granite, marble, corian, plastic or glass. The 2K composite handle with comfort insert comes standard.



	Clamping Capacity	Cup Diameter	Clamping Force	Approx. Weight
PS130	3 1/8"	8 1/4"	265 lbs	10.15 lbs



### B Solid surface seaming tool, PS

Twin vacuum cups for clamping non-porous, solid surface material such as granite, marble, corian, plastic or glass. The levelling toggles ensure smooth surface joint, reduces grinding, sanding and finishing.



	Clamping Capacity	Cup Diameter	Clamping Force	Approx. Weight
PS55	2 1/8"	4 3/4"	48 lbs	3.80 lbs

# Cabinetry clamps face frames

## BESSEY® Quality

The cabinetry clamp is designed to combine the multiple steps of face frame cabinet installation into one easy process. Face frame stiles can be tightened, aligned, pre-drilled and fastened while the clamp is in place. The clamp holds the individual cabinet edges together while also keeping the faces along the joint flush.

There is also an integrated pilot-hole drilling guide on one end. This guide flips out of the way so you can drive screws to connect the cabinets without removing or repositioning the clamp.

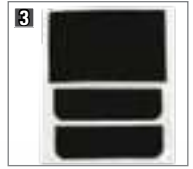

### 1 Durable construction

Heavy duty steel clamp with steel sliding T-bars and aluminum alignment plate provides exceptional strength.

### 2 Integrated pilot hole

Simplifies drilling.

### 3 Non-marring felt pads

Included for clamp faces and alignment plate to protect and cushion points of contact.

### 4 Acme threaded screws

For quick and controlled tightening.

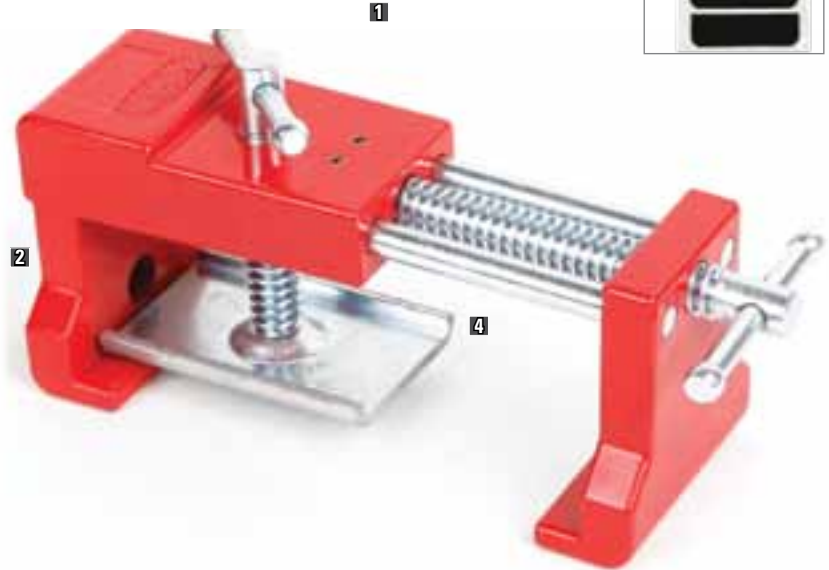

## A Cabinetry clamp, face frames, BES8511

Professional quality installation is achieved at a fraction of the time compared to the use of more conventional clamps. Designed to combine the multiple steps of face frame cabinet installation into one easy process. It works on stiles up to 1 1/4" thick (each). Integrated pilot-hole drilling guide guide flips out of the way so you can drive screws to connect the cabinets without removing or repositioning.

	Clamping Capacity	Throat Depth	Jaw Width	Clamping Force	Approx. Weight
<b>BES8511</b>	4"	1 1/4"	2"	300 - 600 lbs	1.49 lbs
<b>203692</b>	Drill guide assembly				
<b>203708</b>	Spindle service part set				



# GTR

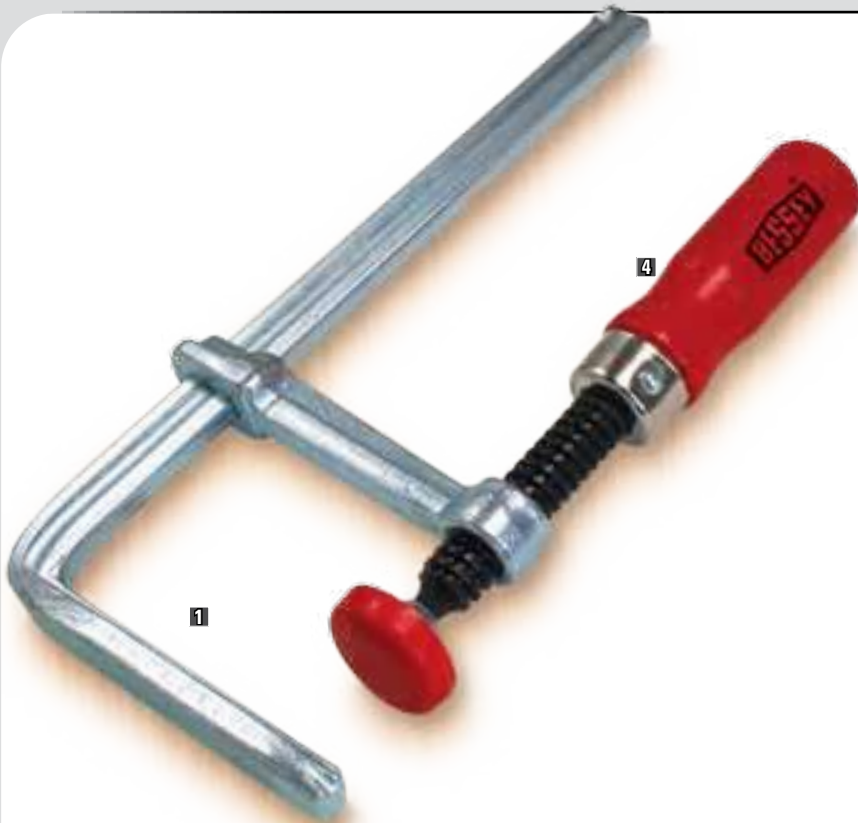

## Track/table clamp

Our newest innovative clamp designed for holding materials safely and securely on MDF tables that are equipped with matrix holes and T-tracks. Precision and durability are at the core of the BESSEY® brand. Our tools have always been manufactured from the highest-grade materials.

- 1 Special lower arm**  
for 12 x 8 mm grooves.
- 2 Safety by design**  
Track saw guide slots make for secure and fast clamping. High clamping force for increased safety.
- 3 Versatility**  
For use with Festool, Protool, Metabo, Makita, DeWalt track saw guides. Please verify track dimensions to confirm suitability.
- 4 Wood handle or lever handle with ratchet action**  
Ergonomically shaped wooden handle or ratchet action lever handle for more clamping force, up to 5 times faster than conventional clamps.



### A Track/table clamp, GTR

High clamping force for safety. Ergonomically shaped wooden handle.



	Clamping Capacity	Throat Depth	Clamping Force	Approx. Weight
<b>GTR12</b>	4 1/16"	2 5/16"	400 lbs	0.66 lbs
<b>GTR16B6</b>	6 5/16"	2 5/16"	400 lbs	0.71 lbs
<b>GTR30B6</b>	11 1/16"	2 5/16"	400 lbs	0.90 lbs



### B Track/table clamp, GTRH

Clamping force is variable, with ratchet action lever up to 5 times faster than conventional clamps. Secure – lever / ratchet unaffected by vibrations. Strong – clamping force up to 540 lbs nominal clamping force.



	Clamping Capacity	Throat Depth	Nominal Clamping Force	Approx. Weight
<b>GTR16S6H</b>	6 5/16"	2 5/16"	540 lbs	1.17 lbs



# Floor tools

## AV2 Spacer

Use the new BESSEY® AV2 floor spacer for fast and simple setup of flooring installations. Simply turn the dial to set the desired gap on your spacers and insert between wall and flooring. When the job is done a simple twist of the dial constricts the spacer for easy removal.

### 1 Clever dial

Set-up is fast and simple. Insert between the wall and the first row of flooring, the distance to the wall can be set by turning the red dial. To remove, simply rotate the dial to release the pressure.

### 2 Wide contact and support surface

Pressure points on the wall and the flooring are avoided with no danger of the spacer slipping or tilting – as can happen with wedges or blocks.

### 3 Exact millimetre scale

Wall surface irregularities of 5 to 20 mm can be compensated for easily. The exact distance for spacing can be readily seen on the millimetre scale.

### 4 "Robust" in the size of a business card

Manufactured from impact and break resistant, glass fibre reinforced polyamide, AV2 Spacer is light and tough and should last for years.



### A AV2 Spacer (Set of 4)

Simply insert between the wall and the first row of flooring. Adjustable to compensate for wall irregularities and removal is a quick turn of the dial to release pressure.

	Opening Range	Jaw Width	Approx. Weight
AV2	3/16" - 13/16"	3 1/2"	0.42 lbs

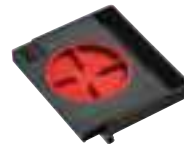

### B Flooring Clamps

Insert between the wall and the first row of flooring. Adjustable to compensate for wall irregularities and removal is a quick turn of the handle to release pressure.

	Opening Range	Jaw Width	Approx. Weight
PVA	1 3/16"	5"	1.03 lbs



### C Flooring Strap Clamps, SVH

Perfect for laying parquet, plank and laminate flooring. 157" strap.

	Strap Length	Clamp Plate Width	Clamping Force	Approx. Weight
SVH400	157"	4 3/4"	220 lbs	1.65 lbs
SVH400XL	300"	4 3/4"	220 lbs	1.80 lbs



# Other clamps

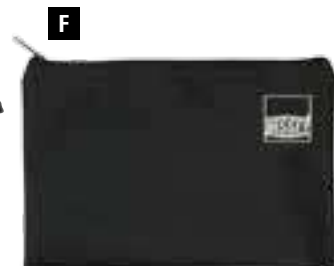
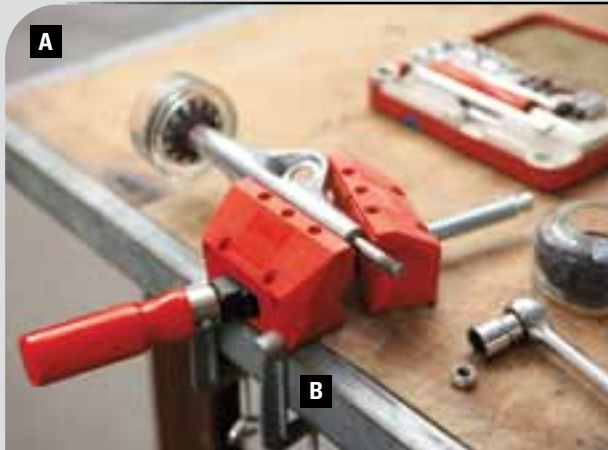

## A Portable Mini-Vise Clamp

The BESSEY® Portable Mini Vise Clamp is ideal for holding round, rectangular and odd shaped objects. It has non-marring glue resistant jaws, and can be clamped to work surface with the TK-6 table clamps. TK-6 clamps included with S-10.

	Jaw Width	Clamping Capacity	Approx. Weight
S-10	3 5/8"	4"	1.80 lb
TK-6	Holds vise clamps to flat work surface		

## B Table mount clamp, TK

Holds your BESSEY® clamps to the edge of a work table to secure your workpiece. Opens to 2 1/4".

Works with...

TK-6	WS-3, WS-6, S-10, and K Body® REVO™ (KRE, KREV, KR & KRV)
------	---

## C Wood handscrew clamps, HS

It's just the clamp you need for gluing; adjustable jaws for a strong grip or delicate for those small projects. The oiled wooden jaws won't damage or slip on your workpiece. The wood handscrew clamp is held together by cold-drawn, carbon-steel spindles and swivel nuts. Large handles for comfort and torque.

	Jaw Length	Clamping Capacity	Throat Depth	Spindle Diameter	Approx. Weight
HS-6	6"	3"	3"	5/16"	1.00 lbs
HS-8	8"	5"	4"	7/16"	1.80 lbs
LHS10	10"	7"	6"	7/16"	2.24 lbs
HS-12	12"	9 1/4"	6"	7/16"	3.85 lbs

## D Panel carrier, KF

Safely transport panels with the BESSEY® panel carrier. The jaws have a high-friction rubber coating that can withstand up to 150 lbs of carrying weight.

	Opening	Approx. Weight
KFP 4102057	1/2" - 2 1/2" service part (2)	2.2 lbs

## E BESSEY® accessory bag

Heavy duty construction. Multiple pockets for tool storage. Heavy duty zippers. Waterproof base.

BTB20

## F Zippered pouch

TPM	medium	16" x 9"
TPL	large	21" x 11"



# Heavy duty vises

## Heavy duty industrial bench vise

The BESSEY® industrial bench vise series sets new standards for durable work holding. Adjustable perfect parallel jaw design provides precision clamping. Sliding guides enhance protection against contamination. Large capacity drop forged pipe jaws are welded in place.

### 1 Durable

Guaranteed unbreakable under normal use

### 2 Top quality materials

90,000 PSI drop forged alloy steel construction on the moveable and stationary jaws as well as the base. Alloy steel spindle handle for fast, high force clamping.

### 3 Precise

Precision ground and induction hardened jaws and anvil

### 4 360 Rotation

Drop forged alloy steel base with locking handle for fast, easy, high force clamping

### 5 Made in Europe

Quality standards; ISO14001, ISO9001, Q1, TÜV SUED /GS



## A Heavy duty industrial bench vise

The BESSEY® industrial bench vise series sets new standards for durable work holding. 100% guaranteed unbreakable drop forged moveable jaws, stationary base and swivel base (\*) for the toughest jobs.

BESSEY® vises with drop forged components are guaranteed against breakage in normal use. This guarantee does not cover abuse, improper use, or handling and storage of the product. Never use cheater bars or pipes to extend the spindle handle. This will void the warranty and can cause injury.

	Jaw Width	Jaw Opening	Throat Depth	Pipe Capacity	Length	Width incl. swivel base	Height incl. swivel base	Anvil size	Approx. Weight
<b>BV-DF4SB</b>	4"	4 1/4"	2 3/8"	1/4 - 3"	12"	7"	5 1/2"	1 7/16" x 2"	14.00 lbs
<b>BV-DF5SB</b>	5"	6 1/2"	3"	1/4 - 3"	15"	8 1/4"	6 3/4"	2" x 2 3/4"	25.20 lbs
<b>BV-DF6SB</b>	6"	7"	4"	1/4 - 5"	19"	10"	8 3/4"	2 1/2" x 3 1/8"	50.00 lbs
<b>BV-DF8SB</b>	8"	10 1/2"	4 1/8"	1/4 - 6"	23 3/4"	10 3/4"	9 1/2"	3" x 3 5/8"	67.30 lbs

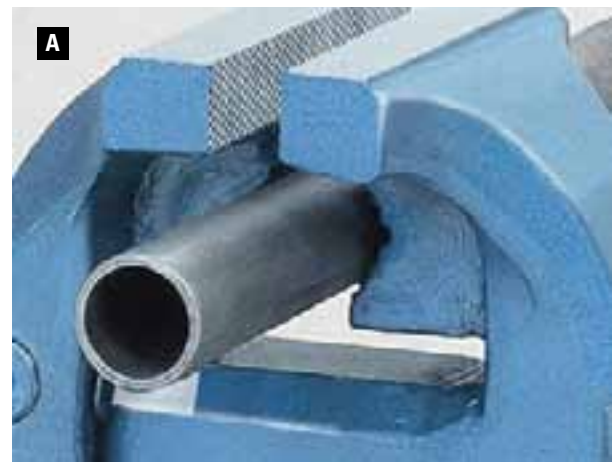



# Vises

## Vises

Similar to clamps, vises are like another pair of hands in the shop. They hold your work securely so that you can saw, grind or drill with both hands. BESSEY® vises have been chosen and offered with an eye for durability and functionality. BESSEY heavy-duty bench vises are made from high quality ductile grey cast iron for many years of service. Many models have swivel bases. All are backed up by BESSEY's limited lifetime warranty. Quality you can trust.

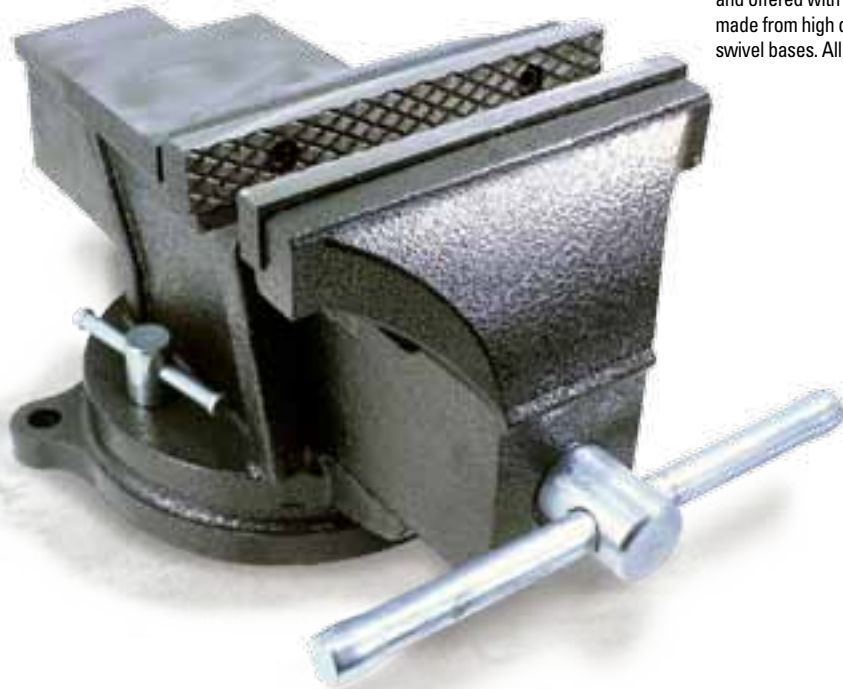

### 1 Choices

A range of products from light duty to heavy duty.

### 2 Made for everyday work

Heavier duty offerings include an anvil, hardened steel jaws and a 360 degree swivel base (270 degrees on the BV-MPV5)

### 3 Robust construction

Strong ductile cast iron construction. Light weight, stronger performance than gray cast (BV-MPV5, BV-HD40, BV-HD60).



### A Multi-purpose vise (rotating pipe and bench vise)

Simply bolt this vise to the top surface of your bench and lock your workpiece in place with the heavy duty jaws. The base swivels 360° with 3 mounting holes and 2 lockdowns. Pipes are no problem with the serrated jaws that rotate 360°. Made with a ductile iron body for durability. Built-in anvil.



	Jaw Width	Jaw Opening	Throat Depth	Pipe Capacity	Approx. Weight
<b>BV-MPV5</b>	5"	5"	2 3/4"	2"	29 lbs



### B Heavy duty bench vise

Simply bolt this vise to the top surface of your bench and lock your workpiece in place with the heavy duty serrated jaws. The base swivels 360° with 3 mounting holes and 2 lockdowns. Built-in anvil.



	Jaw Width	Jaw Opening	Throat Depth	Approx. Weight
<b>BV-HD40</b>	4"	4"	2"	13 lbs
<b>BV-HD60</b>	6"	6"	2 3/4"	27 lbs



### C Light duty bench vise

The base swivels 270° with 4 mounting holes and 1 lockdowns. Made with a cast iron body for durability. Built-in anvil.



	Jaw Width	Jaw Opening	Throat Depth	Pipe Capacity	Approx. Weight
<b>BV-HW45</b>	4"	4"	1 3/4"	1"	11 lbs

### D Drill press vise

Malleable cast iron body with a powder coated finish. Machined spindle. A grooved jaw provides a firm secure grip. The holes are elongated for easy fastening onto a drill press or work surface.

	Jaw Width	Jaw Opening	Throat Depth	Approx. Weight
<b>BV-DP40</b>	4"	4 1/2"	1 1/8"	11 lbs

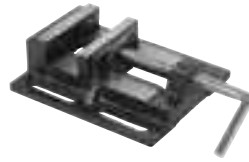

### E Light duty clamp-on vise

When bench space is at a premium this vise is the perfect answer. Completely portable and ideal for light duty work. This clamp attaches to surfaces up to 1.5" thick. Cast in pipe jaws, serrated jaw faces, and double steel guide bars.

	Jaw Width	Jaw Opening	Throat Depth	Pipe Capacity	Approx. Weight
<b>BV-C030</b>	3"	3"	1 1/2"	3/4"	5 lbs

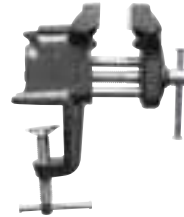

### F Vacuum base vise (swivelling)

This portable hobbyist vise attaches securely to any non-porous surface and, by releasing the locking ring can rotate and swivel and, be re-locked. Comes with non-slip rubber pads for vise jaws.

	Jaw Width	Jaw Opening	Approx. Weight
<b>BV-VB</b>	2 3/4"	2 3/4"	4.50 lbs



### G Multi-purpose vise jaws

Designed to fit any 3-6" vise jaw. The magnetic back helps to keep it into place. Works great for holding wood, metal and tubing. Non-marring

	Jaw Width	Approx. Weight
<b>BV-NVJ</b>	5 1/2"	0.50 lbs

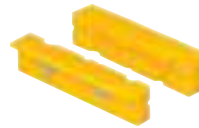

### H Light duty wood vise

This is a versatile vise for home or work. Jaws are pre-drilled for attaching wood facing. For light duty work, made with a cast iron body.

	Jaw Width	Jaw Opening	Throat Depth	Approx. Weight
<b>BV-WV65</b>	6"	6"	2 5/8"	8.50 lbs



### BESSEY® Vise service parts

A range of service parts for the vises listed on these pages.

#### I BV-MPV5 service parts

1. 9050006 Spindle, casting nut, washer, screw and spring pin
2. 9050002 A set of jaw inserts and 4 screws
3. 9050003 A set of pipe jaw inserts and 5 screws
4. 9050004 Locking screws
5. 9050005 Swivel base

#### J BV-HD60 service parts

1. 9060006 Spindle, spring, washer and spring pin
2. 9060002 A set of jaw inserts and 4 screws
3. 9060003 A set of locking screws
4. 9060004 Two part swivel base
5. 9060007 Casting nut, washer and screw

#### K BV-HD40 service parts

1. 9040001 Spindle, spring, washer and spring pin
2. 9040002 A set of jaw inserts and 4 screws
3. 9040003 A set of locking screws
4. 9040004 Two part swivel base
5. 9040005 Casting nut, washer and screw

#### L BV-HW45 service parts

1. 9045001 Vise jaws with screws

#### M BV-DP40 service parts

1. 9044001 Vise jaws with screws

#### N BV-VB service parts

1. 9000001 Vise jaws and jaw covers with screws
2. 9000002 Rubberized base with washer & cotter pin

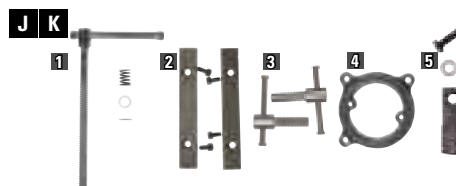
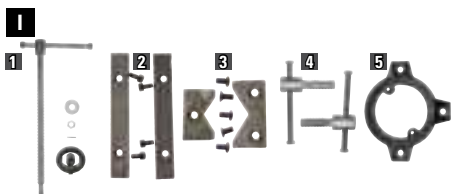

# Portable

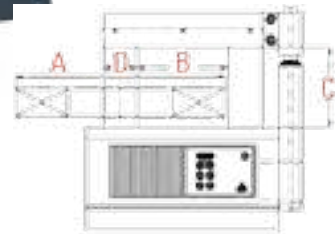

\*Bearings not included

### A Portable digital temperature control, certified PV2412

Includes cross bars standard: 1/4", 3/8", 9/16", 13/16", 1 1/8". Approx. weight: 47 lbs. 120V (15 amp).

	Max. weight ± lb bearings	Min. ID Ø	Max. OD Ø	Max. width B	Max. horizontal heating width C	Cross section poles D	Pole height	Temperature control max reach	Time control max reach
<b>PV2412</b>	44 lbs	3/8"	9 1/2"	4 3/4"	—	1 5/8"	5"	302°F	0-30 min.



\*Bearings not included

### B Portable digital temperature control, certified PVH3813

Vertical or horizontal heating. Includes cross bars standard: 1/4", 3/8", 9/16", 13/16", 1 1/8". Approx. weight: 51 lbs. 120V (15 amp).

	Max. weight ± lb bearings	Min. ID Ø	Max. OD Ø	Max. width B	Max. horizontal heating width C	Cross section poles D	Pole height	Temperature control max reach	Time control max reach
<b>PVH3813</b>	110 lbs	3/8" / Ø 3 3/8"	15"	5 1/4"	5 1/4"	1 5/8" / Ø 3 3/4"	6 1/2"	464°F	0-45 min.



\*Bearings not included

### C Fast action, portable digital temperature control, certified SVH5223

Features swivel arm for faster change ups. Vertical or horizontal heating. Includes cross bars standard: 1/4", 3/8", 9/16", 13/16", 1 1/8". Approx. weight: 112 lbs. 120V (15 amp), and 230V (16 amp) available.

	Max. weight ± lb bearings	Min. ID Ø	Max. OD Ø	Max. width B	Max. horizontal heating width C	Cross section poles D	Pole height	Temperature control max reach	Time control max reach
<b>SVH5223</b>	330 lbs	5/8" / Ø 4 3/4"	20 1/2"	7 7/8"	9"	2 3/8" / Ø 4 1/2"	9"	464°F	0-45 min.
<b>SVH5223 230</b>	330 lbs	5/8" / Ø 4 3/4"	20 1/2"	7 7/8"	9"	2 3/8" / Ø 4 1/2"	9"	464°F	0-45 min.

**WARNING:** Do NOT operate an induction heater if you wear a heart pace-maker. The strong magnetic field emitted by the heater may affect operation of such devices.



## Portable for workshop and on site!

Proper bearing installation is essential to safeguard maximum bearing life. Bearing failures can often be attributed to improper installation and mounting errors. A bearing that is only a few thousandths of an inch out of alignment can have its lifespan cut in half. By heating the inner race to ~250°F prior to installation, the user allows the bearing to expand and slide easily onto the shaft. Magnetic induction is a safe and efficient method of generating heat to expand bearings for installation. No open flame or hot oil to worry about. Magnetic induction heats bearings evenly and quicker than hot plates.

### 1 Digital temperature and time control

All portable models feature a digital time/temperature display and magnetic probe.

### 2 Improve productivity

BESSEY® Induction bearing heaters help you to extend the useful life of your bearings. Reducing the frequency of bearing maintenance means lower operating costs.

### 3 Vertical or Horizontal heating

PVH3813 and SVH5223 allow heating either vertically or horizontally. When in horizontal position, the heating time is 3 to 4 times faster! A 100 lb. unit would heat in under 7 minutes versus more than 25 minutes in the vertical position.

### 4 Fast and flexible manufacturing

Fast heating works on bearings, sprockets, gears, couplings, sleeves.



## D Medium duty digital temperature control, certified, SV5020

Fast, vertical heating of bearings. Includes cross bars: 1 3/16" and 2 3/4". 500V (16 amp).

	Max. weight ± lb bearings	Min. ID Ø	Max. OD Ø	Max. width B	Max. horizontal heating width C	Cross section poles D	Pole height	Temperature control max reach	Time control max reach	Approx. weight without cross bars
<b>SV5020</b>	330 lbs	1 3/16"/Ø4 1/4"	1 3/16"/Ø27 5/64"	7 7/8"	7"	2 3/4"	8 1/4"	464°F	0-60 min.	117 lbs.

D



\*Bearings not included

## E Medium duty digital temperature control, certified, SVH7931

Fast, horizontal heating of bearings. Includes one 3 1/8" cross bar. 500V (16 amp).

	Max. weight ± lb bearings	Min. ID Ø	Max. OD Ø	Max. width B	Max. horizontal heating width C	Cross section poles D	Pole height	Temperature control max reach	Time control max reach	Approx. weight without cross bars
<b>SVH7931</b>	770 lbs	1 3/16"/Ø6 1/4"	31 7/64"	12 1/2"	11"	6 1/4"	12 1/2"	404°F	0-60 min.	275 lbs
<b>SVH7931M</b>	770 lbs	1 3/16"/Ø6 1/4"	31 7/64"	12 1/2"	11"	6 1/4"	12 1/2"	404°F	0-60 min.	396 lbs

E



SVH7931M

\*Bearings not included

## F Magnetic Temperature Probe

Connects to bearing heater. Attaches to inner race of bearing. Up to 350°F (240°C).

MP-PV/PVH/SVH	Fits model PV/PVH/SVH	Approx. Weight 0.13 lbs
---------------	-----------------------	-------------------------

F



G

## G Cross bars for bearing heater models SVH, PV and PVH

	Fits model	Size	Approx. Weight		Fits model	Size	Approx. Weight
<b>SVH 1/16"</b>	SVH5223	9/16" x 3/16" x 14"	1.10 lbs.	<b>PVH 1/4"</b>	PVH3813	1/4" x 1/4" x 9 1/2"	0.20 lbs.
<b>SVH 3/16"</b>	SVH5223/SV5020	1 3/16" x 1 3/16" x 14"	7.28 lbs.	<b>PVH 3/8"</b>	PVH3813	3/8" x 3/8" x 9 1/2"	0.40 lbs.
<b>SVH 2 3/8"</b>	SVH5223	2 3/8" x 2 3/8" x 14"	22.93 lbs.	<b>PVH 1/2"</b>	PVH3813	1/2" x 1/2" x 9 1/2"	0.77 lbs.
<b>SVH 2 3/4"</b>	SV5020	2 3/4" x 2 3/4" x 14"	27.00 lbs.	<b>PVH 13/16"</b>	PVH3813	13/16" x 13/16" x 9 1/2"	1.61 lbs.
<b>SVH 3 1/8"</b>	SVH7931	3 1/8" x 3 1/8" x 20"	55.50 lbs.	<b>PVH 1 1/16"</b>	PVH3813	1 1/16" x 1 1/16" x 9 1/2"	7.21 lbs.
<b>PV 1/4"</b>	PV2412	1/4" x 1/4" x 7 7/8"	0.15 lbs.				
<b>PV 3/8"</b>	PV2412	3/8" x 3/8" x 7 7/8"	0.31 lbs.				
<b>PV 1/2"</b>	PV2412	1/2" x 1/2" x 7 7/8"	0.64 lbs.				
<b>PV 13/16"</b>	PV2412	13/16" x 13/16" x 7 7/8"	1.32 lbs.				
<b>PV 1 1/16"</b>	PV2412	1 1/16" x 1 1/16" x 7 7/8"	5.22 lbs.				

# SC, BC series heaters and accessories

**D**



\*Cross bars not included

**G**

**A**



\*Accessories not included



SC 110V \*Bearings not included

**A Induction bearing heater SC110V (120V or 220V)**

Bearing capacity: 4" x 11" O.D. (14"OD with optional raising blocks).

	Voltage	Standard Cross Bars	Optional Cross Bars	Approx. Weight
<b>SC 110V</b>	120V (17 amp)	¾, 2	1 ¼	49.60 lbs
<b>SC 220V</b>	240V (11 amp)	¾, 2	1 ¼	52.00 lbs

**B Digital Temperature Control, induction bearing heater SC 110D (120V or 220V)**

Bearing capacity: 4" x 11" O.D.(14"OD with optional raising blocks). Computer chip monitors and stabilizes temperature. Display panel (pre-set times, temperatures) and auto shut off.

	Voltage	Standard Cross Bars	Optional Cross Bars	Approx. Weight
<b>SC 110D</b>	120V (20 amp)	¾, 2	1 ¼	53.50 lbs

**C**



\*Cross bars not included

**C Induction bearing heater BC (240V, or 480V, or 600V)**

Bearing capacity: 7 ½" x 22" O.D. (32"OD with optional raising blocks).

	Voltage	Standard Cross Bars	Optional Cross Bars	Approx. Weight
<b>BC 220V</b>	240V (30 amp)	1 ¼, 3	1, 2	176.00 lbs
<b>BC 440V</b>	480V (20 amp)	1 ¼, 3	¾, 1, 2	176.00 lbs
<b>BC 550V</b>	600V (15 amp)	1 ¼, 3	¾, 1, 2	176.00 lbs

## Quick and dependable

Proper bearing installation is essential to safeguard maximum bearing life. Bearing failures can often be attributed to improper installation and mounting errors. A bearing that is only a few thousandths of an inch out of alignment can have its lifespan cut in half. By heating the inner race to ~250°F prior to installation, the user allows the bearing to expand and slide easily onto the shaft. Magnetic induction is a safe and efficient method of generating heat to expand bearings for installation. No open flame or hot oil to worry about. Magnetic induction heats bearings evenly and quicker than hot plates.

All Induction Bearing Heaters on this page are single phase 60 hz units. 50 hz versions available as special request.

### 1 Proven Tools

Tried and true models that are simple, durable and get the job done!.

### 2 Easy to Use

SC, BC and BCS models come with a simple On/Off while SC110D features a digital time/temperature display and magnetic probe.

### 3 Relevant Accessories

120 V/15A, 60/60 Hz units have extra available raising block, cross bars and a pyrometer/thermometer to make work easier for more difficult projects.

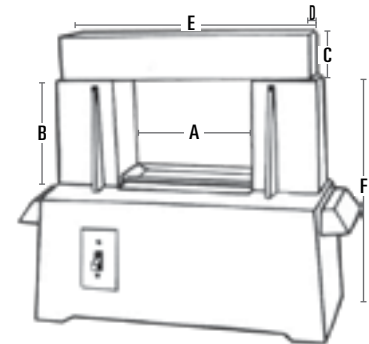

	A	B	C	D	E	F
<b>SC</b>	4 3/8"	3 5/8"	3/4" - 2"	3/4"	9 1/4"	9"
<b>BC</b>	8"	7"	1 1/4" - 3"	1 1/4"	14 3/4"	16"
<b>BCS</b>	12 1/4"	7"	1 1/4" - 3"	1 1/4"	18 3/4"	16"

## D Model BC Special (240V, or 480V or 600V)

Bearing capacity: 11 1/2" x 22" O.D. (32"OD with optional raising blocks).

	Voltage	Standard Cross Bars	Optional Cross Bars	Approx. Weight
<b>BCS 220</b>	240V (30 amp)	1 1/4, 3	1, 2	199.00 lbs
<b>BCS 440</b>	480V (20 amp)	1 1/4, 3	1, 2	199.00 lbs
<b>BCS 550</b>	600V (15 amp)	1 1/4, 3	1, 2	199.00 lbs

## E Raising blocks for SC, BC, BCS models

Increases the maximum size of bearing that can be heated.

	Fits model	Height	Width	Approx. Weight
<b>SCRB</b>	SC	2 3/8"	2 5/8"	7.50 lbs.
<b>BCRB</b>	BC, BCS	5"	3 5/8"	31.00 lbs.



## F Pyrometer/Thermometer

Multi-purpose measuring device for bearings, gears, etc. Digital readout from -200°C (-328°F) to +1372°C (+1999°F). Probe max rated for 650°C (1200°F).

		Approx. Weight
<b>HH11C</b>	Pyrometer/Thermometer with probe & flex cord	2.00



## G Cross bars for SC, BC, BCS bearing heater models

	Fits model #		Fits model #
<b>SC 3/4</b>	SC	<b>BCS 1<sup>(1)</sup></b>	BC Special
<b>SC 1 1/4<sup>(1)</sup></b>	SC	<b>BCS 1 1/4</b>	BC Special
<b>SC 2</b>	SC	<b>BCS 2<sup>(1)</sup></b>	BC Special
<b>BC 3/4<sup>(1)(2)</sup></b>	BC	<b>BCS 3</b>	BC Special
<b>BC 1<sup>(1)</sup></b>	BC	<b>SC on/off</b>	On/Off switch for SC
<b>BC 1 1/4</b>	BC	<b>BC on/off</b>	On/Off switch for BC
<b>BC 2<sup>(1)</sup></b>	BC		
<b>BC 3</b>	BC		



<sup>(1)</sup> Special order only. <sup>(2)</sup> WARNING: Do NOT use with model BC 220V



# GCS-CB and GCS-NCB (non induction)



## BESSEY® Versatility

Heating a bearing expands it for precise placement and alignment on the shaft without damage. Pressing (driving) a cold bearing onto a shaft can cause it to misalign – as little as a 0.001" difference can reduce a bearing's lifespan by 50%.

Bearing heaters generate clean, even heat for precision placement, resulting in extended bearing life. Heating alternatives such as hot oil baths and torches are messy and dangerous. Torches and element tops create uneven heat and expansion and cause hot spots that can change the metallurgical properties of the bearing steel.

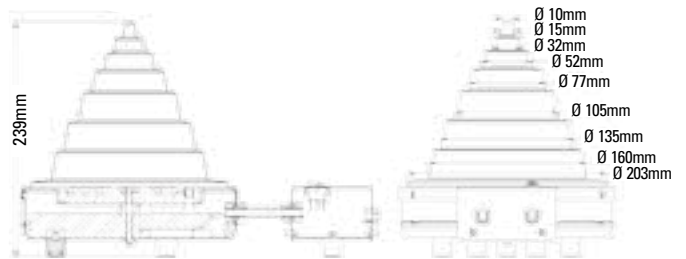

### A Cone style bearing heaters (non-induction)

Flexible manufacturing repairs for press-fit applications.

- Lower cost than larger induction heaters
- Lightweight and portable, easy to move around a shop or factory floor
- No special wiring or set up, uses standard wall plugs 120 V / 15 A
- Start and stop with a switch
- One cone bearing heater fulfills a range of bearing sizes
- Temperature preset on -CB versions, 250° F.

	Bearing I.D. Range	Voltage	Width	Height	Approx. Weight
<b>GCS-NCB</b>	3/8" - 8 1/4"	120V (15 amp)	8 5/8"	9 1/2"	6.00 lbs.
<b>GCS-CB*</b>	3/8" - 8 1/4"	120V (15 amp)	8 5/8"	9 1/2"	6.00 lbs.

\*Comes with control box with probe attached.



### B Bearing Mounting Unit, BRG33

Safe, precise and quick mounting of bearings, bushings, sealing rings, etc. The bearing is supported on its inner and outer ring during installation. The clear size markings, and impact resistant collets (made of durable sheet material) minimize damage to, and extend the life of, expensive bearings. This mounting unit is specially designed for quick, accurate, damage free and safe mounting of bearings with bore dimensions of 10 to 50mm and O.D. 26 - 110mm.

Set Includes

Approx. Weight

**BRG33** 33 rings; 3 impact sleeves (alu); dead-blow hammer & carrying case 10.60 lbs.

# Industrial magnets

## Industrial Magnets

When getting ready to weld two pieces of steel together a good magnetic square is like having a third hand. For a fast & simple set-up these high quality ferrite magnets hold work at pre-set angles of 45, 90 and 135 degrees, or can be linked together to form any angle you need. Something so simple but so versatile! Use one in your workshop to hold steel parts while you do the welding. Speed up your production time with BESSEY®'s easy to set up and remove magnetic squares.

- 1 Quality**  
Quality magnets for fast, simple set-ups
- 2 Flexibility**  
Often referred to as "an extra set of hands"
- 3 Variety**  
The wide variety of BESSEY® industrial magnets will offer most metal workers an option that fits their needs
- 4 Speed**  
A simple fast set-up and removal to help increase productivity while you work.



### A Magnetic squares, WMS

Simple magnets to hold work at set angles.

	Pull	Nominal Dimensions	Pre-set Angles	Approx. Weight
<b>WMS-1</b>	66 lbs	3 3/4" x 4 3/8" x 3/4"	90/45°	1.04 lbs
<b>WMS-3</b>	48.5 lbs	3 3/8" x 3 3/8" x 5/8"	90/45°	0.59 lbs
<b>WMS-5</b>	112 lbs	3 3/4" x 4 3/8" x 3/4"	90/45°	1.29 lbs



### B Double magnetic square, WMS

The double magnets are joined at a pivot point and can hold at any angle.

	Pull	Nominal Dimensions	Pre-set Angles	Approx. Weight
<b>WMS-4</b>	2 x 48.5 lbs	6 1/8" x 3 3/8" x 5/8"	0 to 180°	1.38 lbs



### C Multi-angle magnetic square, WMS

A quality magnetic multi-angle square for fast, simple set-up.

	Pull	Nominal Dimensions	Pre-set Angles	Approx. Weight
<b>WMS-6</b>	35 lbs	4" x 2 1/2" x 9/16"	30/45/60/75/90°	0.50 lbs



### D Arrowhead magnetic square, WMS

A quality magnetic multi-angle square for fast, simple set-up.

	Pull	Nominal Dimensions	Pre-set Angles	Approx. Weight
<b>WMS-7</b>	41 lbs	4 3/4" x 3 1/4" x 9/16"	90/45°	0.69 lbs



# Industrial magnets



## E "Chunky" magnetic square, CMS

Release your magnet with the convenient T-handle.

	Pull	Nominal Dimensions	Pre-set Angles	Approx. Weight
<b>CMS-1</b>	100 lbs	3 3/4" x 4 3/8" x 1 5/8"	90/45°	2.60 lbs



## F "Big Daddy" magnetic square, BDMS

A quality magnetic square with a convenient T-handle for a quick release.

	Pull	Nominal Dimensions	Pre-set Angles	Approx. Weight
<b>BDMS-1</b>	100 lbs	8" x 8" x 1 5/8"	90/45°	10.00 lbs



## G Magnetic ground clamps, MGC

Ground clamps only need base surface metal for clamping.

	Pull	Nominal Dimensions	Amps	Approx. Weight
<b>MGC-1</b>	55 lbs	3 1/2" x 2"	250	1.50 lbs
<b>MGC-2</b>	55 lbs	3 1/2" x 2"	800	1.55 lbs



## H Mag Pick-Up, MPU

Magnetic disc on 35" tubular shaft for picking up small metal parts – also useful during clean-up.

	Description	Approx. Weight
<b>MPU-1</b>	Magnetic disc on 35" tubular shaft	2.10 lbs



## I MagStick, MS

The MagStick is a 5 1/2" "pen-sized" pocket magnet that extends to 25 1/2" to pick-up hard to reach small metal objects.

	Description	Approx. Weight
<b>MS-1</b>	Magnet on 25 1/2" telescopic shaft, pocket clip	0.16 lbs

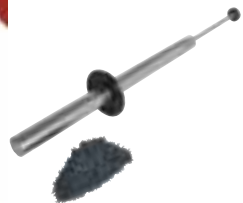

## J MagWand, MW

Can collect up to 12 lbs of swarf in a pass for a cleaner safer welding and machine shop. It rolls easily over industrial work surfaces and dumps waste by simply pulling and sliding the magnetic insert.

	Description	Approx. Weight
<b>MW-1</b>	15 1/2" length	1.50 lbs



## K MagSweep, MSP

The MagSweep is a rolling shop-floor magnet on wheels that makes clean up quick and easy.

	Description	Approx. Weight
<b>MSP-24</b>	24" swath	39.00 lbs



# High quality work with less effort



Traditional tin snips

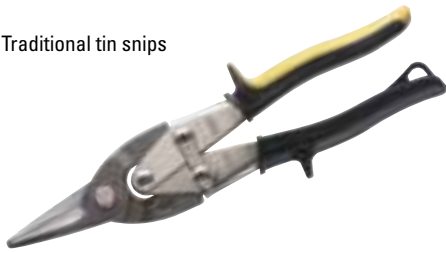

Compound leverage snips

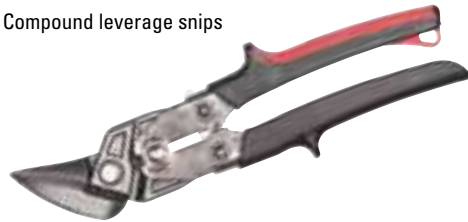

Ideal snips

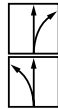

Continuous, straight and curved cuts, right



Continuous, straight and curved cuts, left

Outline cutting snips



Short, straight and narrow curved cuts, right



Short, straight and narrow curved cuts, left

Straight cutting snips



Straight and curved cuts, large radius in both left and right directions



Short, straight cuts, notch

Left cutting snips



Right cutting snips



## 1 Types

### Traditional tin snips

Edges and handle are traditionally forged into one unit. The force required for cutting is determined by the ratio of edge length to the handle length.

### Compound leverage snips

The cutting heads and handles are made separately and are both hinged. When they're attached to each other, this double hinged (double fulcrumed) assembly greatly increases the leverage, requiring less physical effort.

## 2 Models

### Ideal snips

These multi-purpose snips cut through a metal sheet (straight-cut) as well as large and small contours or radii (outline-cut). They cut at the edge (edge cut) or at the centre of a sheet. Ideal snips can also be used for notching-operations.

### Outline cutting snips

Best suited for fine and narrow radius cuts near the edges of a metal sheet. Use the delicately shaped edge of these snips to cut extremely narrow shapes or curves.

### Straight cutting snips

Ideal for cutting a metal sheet at the centre and/or near the edges. You can use long edges of this tool to cross-cut and notch large metal sheets quickly and precisely with less effort.

## 3 Right cutting or left cutting snips.

### What's the difference?

Right cutting snips are designed so that they can cut right radii, a curve from left to right easily. Left cutting snips are the best for radius cuts from right to left.

The common perception is that, right cutting snips are for right-handers, and left cutting snips for left-handers. This is not true. If a right-handed person is cutting a radius from left to right, using right cutting snips (radius from left to right), you have to cut outwards from your wrist. With left cuttings snips, (radius is then from right to left) you can cut inwards from your wrist. This is considerably more ergonomic. Try it out once!

## 4 Grades

The service life of cutting edges depends directly on the grade of steel used and the processing. High-performance snips with case-hardened HSS – edges fulfill the most stringent requirements regarding service life and cutting performance. Cutter heads of the HSS-Tin grade are additionally coated with extremely hard titanium nitride that reduces wear and tear. Other cutting materials, namely special high quality steel, quality steel and standard quality steel, are available depending on the application and the frequency of use.

Grades of blade steel	min. HRC	Durability	Approx. Tensile Strength of Blade PSI	Max. Sheet thickness at tensile strength of:		
				58 000 PSI Mild Carbon Steel	116 000 PSI Hard Carbon Steel	159 000 PSI Very Hard Stainless
<b>HSS</b> D27AH	65	++++	370,000	1.5 mm/16 ga	1.2 mm/18 ga	0.6 mm/25 ga
<b>Special High Grade Steel</b> D15, D16, D29SS; D29ASS; D123S; D39ASS	61	+++	320,000	1.5 mm/16 ga	1.2 mm/18 ga	/
<b>High Grade Steel</b> D22A; D27	59	++	300,000	1.5 mm/16 ga	1.2 mm/18 ga	/

# D39 Next generation snip



## D39, the latest generation of leverage snips

BESSEY®'s innovative D39ASS brings an entirely new generation of compound leverage cutting snips to the market for the sheet metalworking industry. These snips enable more capacity, precision and comfort with easier operation as a result of innovative design and unique construction elements.

### 1 Easier to hold

The new D39ASS snips enjoy an optimised handle angle that allows one to comfortably grip the entire unit for maximum application of cutting force.

### 2 Smooth cutting action

The joint area includes a sintered steel insert. This clever addition greatly reduces friction where it counts! Great for extending the tool life and for an exceptionally smooth cutting action.

### 3 Convenient latch

A central latch on the top of the handle allows right and left-handed users to open and close the snips with ease, without a change in grip.

### 4 Cut straight, cut round, cut easier

The compact forged jaws permit high-precision cutting of curves while also being very effective at straight cuts – while the shape of the forged jaw allows work to flow past the user's hand instead of towards for sustained (...and safer) cutting.



## A Multi-use aviation snip, D39ASS

For continuous straight and curved cuts. Extremely compact cutter head with partially countersunk head screw connection for increased manoeuvrability and precision on curved cuts. Joint area screw connection with stud bolt, sintered disc and maintenance-free spring for extreme robustness. Reduced handle opening for optimised handling and an even cutting length.

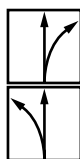

	Overall Length	Blade Length	Cutting Capacity (carbon steel)	Approx. Weight
<b>D39ASS-SB</b>	9 3/16"	1 5/16"	18 gauge	1.15 lbs
<b>D39ASSL-SB</b>	9 3/16"	1 5/16"	18 gauge	1.15 lbs



# D15A Compact aviation snip

## A compact design for a high performance with minimum effort

Smaller than the typical aviation snip – for working in small spaces – with all the power you need. Extremely small forged heads have optimized blade geometry and fine-tuned cutting leverage in a much smaller overall length. Fits well in a pocket, a tool pouch or tool box. Small, strong, and manoeuvrable.

### 1 100% Power, 75% size

The D15A Compact Aviation Snip has all the power of a full size aviation snip, and is 25% smaller.

### 2 Extremely compact cutting head

Extremely compact cutting head for great manoeuvrability, cutting the narrowest radii. The head geometry allows the surface being cut to slide past beneath your fingers to reduce the chance of injury.

### 3 Practical locking mechanism

The practical locking mechanism allows for opening and closing with one hand.

### 4 Compound leverage

Compound leverage considerably reduces the effort required. Improve productivity, reduce fatigue.

### 5 Ergonomic handle

Ergonomic soft grip handles keeps hand from slipping.



## A Multi-use snip, compact aviation snip, D15A

Compact design for high performance with minimum effort. Smaller than typical aviation snip – for working in small spaces with all the power you need. For long continuous, straight and curved cuts.

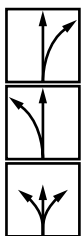

	Overall Length	Blade Length	Cutting Capacity (carbon steel)	Approx. Weight
<b>D15A-BE</b>	7 <sup>3</sup> / <sub>16</sub> "	1"	18 gauge	0.44 lbs
<b>D15AL-BE</b>	7 <sup>3</sup> / <sub>16</sub> "	1"	18 gauge	0.44 lbs
<b>D15S-BE</b>	7 <sup>3</sup> / <sub>16</sub> "	1 <sup>1</sup> / <sub>8</sub> "	18 gauge	0.44 lbs
<b>D15-SET</b>	1x D15S-BE, 1x D15A-BE, 1x D15AL-BE in a nylon pouch			



## B Aviation snips, D16

High grade steel cutting blades with micro-serrations for slip proof cutting. HRC up to 59.

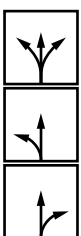

	Overall Length	Blade Length	Cutting Capacity (carbon steel)	Approx. Weight
<b>D16S</b>	9 <sup>1</sup> / <sub>2</sub> "	1 <sup>3</sup> / <sub>4</sub> "	18 gauge	1.25 lbs
<b>D16L</b>	9 <sup>1</sup> / <sub>2</sub> "	1 <sup>9</sup> / <sub>16</sub> "	18 gauge	1.25 lbs
<b>D16</b>	9 <sup>1</sup> / <sub>2</sub> "	1 <sup>9</sup> / <sub>16</sub> "	18 gauge	1.25 lbs
<b>D16-SET</b>	1 x D16S, 1 x D16L, 1 x D16 in a nylon pouch			





# Multi-purpose cutters



C

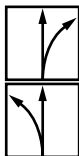

### C Offset snips, optimized, D29ASS-2

High grade steel cutting blades with compact cutting head for high manoeuvrability. Use 25% less effort with the optimized leverage. Right or left cutting versions available. HRC up to 61.

	Overall Length	Blade Length	Cutting Capacity (carbon steel)	Approx. Weight
D29ASS-2	10 1/4"	1 7/8"	18 gauge	1.16 lbs
D29ASSL-2	10 1/4"	1 7/8"	18 gauge	1.16 lbs



D

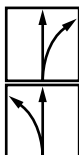

### D Offset extra hard, high tolerance snip, D27AH

Made for long continuous, straight and curved cuts. Case-hardened, high-speed steel edges. Right or left cutting versions available. HRC up to 68.

	Overall Length	Blade Length	Cutting Capacity (carbon steel)	Approx. Weight
D27AH-BE	10 1/8"	1 7/8"	18 gauge	1.22 lbs
D27AHL-BE	10 1/8"	1 7/8"	18 gauge	1.22 lbs



E



### E Special hard cutting snips, D29SS-2

High grade steel cutting blades with micro-serrations for slip proof cutting. Right or left cutting versions available. HRC up to 61.

	Overall Length	Blade Length	Cutting Capacity (carbon steel)	Approx. Weight
D29SS-2	10 1/8"	1 9/16"	18 gauge	1.03 lbs
D29SSL-2	10 1/8"	1 9/16"	18 gauge	1.03 lbs



F



### F Long-nose, multi-purpose snip, D22A

High grade steel, extra long cutting blades designed for continuous cuts and large radius cuts. Angled cutter heads keep hands free from work. Available in left cutting version only. HRC up to 59.

	Overall Length	Blade Length	Cutting Capacity (carbon steel)	Approx. Weight
D22A	10 1/2"	2 1/2"	18 gauge	1.01 lbs



G



### G Safety strap cutter, D123

Holds banding tightly during cutting to prevent the banding from springing up. Can cut steel straps up to 32 x 1 mm (1 1/4" x 1/32") with one hand. The ergonomic handle and the compound leverage offers comfort and ease of use.

	Overall Length	Blade Length	Approx. Weight
D123S-SB	9 7/8"	1 1/2"	1.21 lbs

## MultiSnips, D48A

Snips/shears/scissors tend to be designed to fall into 1 of 3 broad use categories; sheet metal (tin snips), fabric shears & lastly paper cutting. The BESSEY® the 48A MultiSnip has no specialty, thus creating a new 4th category - the multipurpose snip. The 48A's Stainless steel blades work well on a wide variety of materials. Light weight & pocket sized. It is a great tool to have close at hand both at work and at home.

### 1 Stainless steel blade

Increased durability and cutting results. Cuts both thin metal sheets as well as a variety of soft materials such as paper, fabrics and cardboard.

### 2 Offset blades

The practical locking mechanism allows for opening and closing with one hand while limiting the maximum opening of the snip.

### 3 Thumb lock

Provides easy locking for increased safety.

### 4 Spring leverage

Spring opens cutter automatically, improving productivity while reducing hand fatigue.



## A MultiSnips

Made for everyday light duty use with a stainless steel blade. The spring opens cutter automatically and it features a thumb operated lock.

	Overall Length	Blade Length	Approx. Weight
<b>Straight Blade, D47, D48</b>			
<b>D47</b>	5 3/4"	1 1/4"	0.13 lbs
<b>D48</b>	7 1/2"	1 5/8"	0.25 lbs
<b>Offset Blade, D48A</b>			
<b>D48A</b>	7 3/8"	1 3/8"	0.25 lbs



## B Cable cutter, D49

Used for cutting multi-core cable with diameters up to 10 mm (3/8"). Stainless steel blade.

	Overall Length	Blade Length	Approx. Weight
<b>D49</b>	6 5/8"	1"	0.25 lbs



# Multi-purpose cutters



## Combinox, D50

These versatile multi-purpose snips are equally at home in the toolbox, kitchen gadget drawer or garden shed. The handles are plastic with a soft cushion insert for comfort and to prevent slipping.

### 1 Stainless steel blade

Increased durability and cutting results. Notched for wire stripping, these cut thin metal sheets, cable, and a wide range of material.

### 2 Thumb lock

Provides easy locking for increased safety.

### 3 Spring leverage

Spring opens cutter automatically, improving productivity while reducing hand fatigue.

### 4 Ergonomic handle

Ergonomic handle with soft insert.



### A Combinox, D50

The stainless steel blade cuts a wide range of material, and is notched for wire stripping. The spring opens cutter automatically with a thumb operated lock. Ergonomic handle with soft-insert.

	Overall Length	Blade Length	Approx. Weight
D50	7 5/8"	2"	0.25 lbs



### B MultiSnip master, D51A

The stainless steel cutter edge cuts a wide range of material. The angled cutter head keeps your hands safely free from work. The handle is made of robust fibreglass-reinforced plastic with soft-insert.

	Overall Length	Blade Length	Approx. Weight
D51A	9 1/4"	2"	0.25 lbs



## Razor sharp cuts

Quick-change blade-replacement system, no tools required, one-hand easy opening & closing. Folds to a compact size to fit in a pocket and also includes a stainless steel belt clip for easy access. Three handle styles to choose from, aluminum, wood inlay & composite plastic. These handy knives accept all standard utility blades.

### 1 Blade change mechanism

Lever for safe locking of blades. This mechanism permits a quick and easy blade change.

### 2 Soft thumb pad

Soft plastic thumb pad allows maximum pressure.

### 3 Storage compartment

Safe storage of spare blades so they are always quickly accessible. Comes standard with 5 extra blades.

### 4 Release lever

It needs just a short push on the metal release lever to unlock the knife so that it can be safely folded.



## A Folding utility knife – ABS comfort grip handle

Includes folding and locking blade with belt-clip; thumb cushion for maximum contact pressure; replacement blade compartment and 5 extra blades. Uses standard blades. Features quick blade exchange mechanism and spring blade release.



	Overall Length	Blade Length	Approx. Weight
D-BKPH	6 1/4"	2 3/8"	0.32 lbs



## B Folding utility knife set - ABS comfort grip handle

Includes 4 types of blades: standard, scoring, linoleum, and hook (rug). Convenient case for storage. 2 3/8" H x 6 3/4" W x 4 3/8" D

	Approx. Weight
DBKPHSET	0.96 lbs

Scoring 2 pcs	Hook 5 pcs	Linoleum 2 pcs	Standard 10 pcs
------------------	---------------	-------------------	--------------------

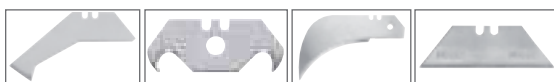

# Multi-purpose cutters

Quick-change blade-replacement system, no tools required, one-hand easy opening & closing. Folds to a compact size to fit in a pocket and also includes a stainless steel belt clip for easy access. Three handle styles to choose from, aluminum, wood inlay & composite plastic. These handy knives accept all standard utility blades.



**1 Blade change mechanism**

Lever for safe locking of blades. This mechanism permits a quick and easy blade change.

**2 Release lever**

It needs just a short push on the metal release lever to unlock the knife so that it can be safely folded.



**A Folding utility knife – Wood handle**

Includes folding and locking blade with belt-clip. Uses standard blades that are easy to change with the quick blade exchange mechanism. Spring blade release.



	Overall Length	Blade Length	Approx. Weight
<b>D-BKWH</b>	6 1/4"	2 1/4"	0.39 lbs



**B Folding utility knife – Aluminum handle**

Includes folding and locking blade with belt-clip. Uses standard blades that are easy to change with the quick blade exchange mechanism. Spring blade release.



	Overall Length	Blade Length	Approx. Weight
<b>D-BKAH</b>	6 1/4"	2 3/8"	0.29 lbs



**C Multi-function tool**

1 multi tool with 7 options: Shears, blade, saw, file, Phillips head screwdriver and large and small slotted screwdriver. It can also cut leather, rope, vinyl, thin cable, cord, thin plastic, paper, etc. Includes a belt pouch for handy storage.



	Handle Length	Cutting Edge Length	Total Length	Approx. Weight
<b>DBST</b>	4"	2 1/8"	7"	0.66 lbs

# Industrial fluids and compounds



## A Lab-metal

The original ready-to-use metal putty can be drilled, tapped, ground, milled, chisselled, sanded, etc. To build up, apply in thin layers, allow to dry, repeat. Drying time for 1/8" = 3-4 hours.

	Unit/Container	Approx. Weight/Case
LM-06	6 oz / 170 g	6.00 lbs
LM-12	12 oz / 340 g	13.00 lbs
LM-24	24 oz / 680 g	23.00 lbs
LM-48	48 oz / 1.4 g	42.00 lbs

## B Hi-Temp Lab-metal

Dry 24 hours then cure 425° 1 hour.

	Unit/Container	Approx. Weight/Case
HT-14	14 oz / 397 g	15.00 lbs
HT-24	24 oz / 680 g	23.00 lbs

## C Lab-solvent

Surface-prep for regular and Hi-Temp Lab-metal. Thins Lab-Metal for brushing or spraying and leaves no film.

	Unit/Container	Approx. Weight/Case
LS-16	16 oz / 473 g	16.00 lbs

## D Relton OPTION 1® cutting fluid

An environmentally friendly cutting fluid that has no chlorine, no sulfur, a non-toxic formula that's safe to use. Water based.

	Unit/Container	Approx. Weight
OPT455	12 x 16 oz/473 ml	14.80 lbs/case
OPT4	4 x 1 US gal/3.785L	36.10 lbs/case

## E Relton A-9® aluminum cutting fluid

Use for tapping, drilling, boring, milling, sawing, reaming and broaching. Specifically designed for aluminum; also works well on many other metals.

	Unit/Container	Approx. Weight
A9114	24 x 4 oz/118 ml	9.00 lbs/case
A9455	12 x 16 oz/473 ml	16.00 lbs/case
A94	4 x 1 US gal/3.785L	33.00 lbs/case

## F Relton Rapid Tap® cutting fluid

Leaves a fine machined finish even on tough materials such as aluminum, beryllium, brass, bronze, cast iron, copper, inconel, magnesium, molydenum, stainless steel, and stellite.

	Unit/Container	Approx. Weight
RT114	24 x 4 oz/118 ml	11.00 lbs/case
RT455	12 x 16 oz/455 ml	17.00 lbs/case
RT4	4 x 1 US gal/3.785L	42.00 lbs/case

## G Torque multipliers, JM

The geared head offers 4X the power of an ordinary wrench alone, and requires no air or electricity. Use with a torque wrench when precision is required (always calibrate). JM units can be stacked for higher power. Up to 12,000 ft. lbs. of torque.

	Input Capacity foot/lbs	Output Capacity foot/lbs	Input Drive	Output Drive	Ratio lb:foot	Approx. Weight
JM-750	250	1,000	1/2"	3/4"	4 to 1	5.88 lbs
JM-1000	500	2,000	3/4"	1"	4 to 1	11.74 lbs





# Index

Catalog number	UPC	Case qty.	Page no.
1000L	7 88502 14140 6	1	32
1001S	7 88502 14141 3	1	32
1200-S8	7 88502 20032 5	10	1
1200-S12	7 88502 20015 8	10	1
1200-S18	7 88502 20016 5	5	1
1200-S24	7 88502 20017 2	5	1
1800-S8	7 88502 20000 4	5	1
1800-S12	7 88502 20001 1	5	1
1800-S18	7 88502 20002 8	5	1
1800-S24	7 88502 20003 5	5	1
1800L-12	7 88502 00986 7	5	19
203692	7 88502 20369 2	10	50
203708	7 88502 20370 8	10	50
203715	7 88502 20371 5	10	23
203722	7 88502 20372 2	10	23
2400 HD-10	7 88502 00995 9	1	33
2400J-12	7 88502 19032 9	5	15
2400S-8	7 88502 00801 3	5	2
2400S-12	7 88502 00803 7	5	2
2400S-16	7 88502 00807 5	5	2
2400S-20	7 88502 00804 4	5	2
2400S-24	7 88502 00808 2	5	2
2400S-36	7 88502 00809 9	5	2
2400S-48	7 88502 00815 0	1	2
2400S-60	7 88502 00806 8	1	2
3005122	7 88502 00939 3	1	5
3006727	7 88502 20101 8	25	5
3006786	7 88502 20102 5	25	5
3100398	7 88502 00547 0	1	5, 18
3100399	7 88502 00548 7	1	5, 18
3100400	7 88502 00549 4	1	5
3100401	7 88502 00550 0	1	5
3100459	7 88502 00533 3	1	34
3100576	7 88502 20173 5	1 pair	47
3100579	7 88502 00940 9	1	5
3100736	7 88502 00920 1	1	5, 18, 40
3100737	7 88502 00924 9	1	5
3100920	7 88502 20128 5	1	23
3100953	7 88502 20192 6	1	21
3100954	7 88502 20193 3	1	21
3100998	0 91162 00115 8	2	48
3101179	7 88502 00749 8	1	14
3101180	7 88502 00752 8	1	5, 14
3101182	7 88502 00748 1	1	14
3101183	7 88502 00751 1	1	5, 14
3101186	7 88502 00747 4	1	14
3101187	7 88502 00746 7	1	14
3101188	7 88502 00750 4	1	5, 14
3101192	7 88502 00921 8	1	5, 18, 40
3101193	7 88502 00922 5	1	5, 18, 40
3101329	7 88502 20179 7	1	5, 18
3101330	7 88502 20168 1	1	5, 18
3101331	7 88502 20180 3	1	5, 18
3101332	7 88502 20302 9	1	5
3101337	7 88502 20299 2	1	18
3101338	7 88502 20257 2	1	18

Catalog number	UPC	Case qty.	Page no.
3101339	7 88502 20109 4	1	5
3101392	0 91162 00121 9	1	14
3101394	0 91162 00123 3	1	14
3101395	0 91162 00124 0	1	14
3101396	0 91162 00125 7	1	14
3101402	0 91162 00131 8	1 set	28
3101403	0 9116200132 5	2	48
3101405	7 88502 20129 2	1	23
3101407	7 88502 20306 7	1	5
3101426	7 88502 20263 3	1	18
3101428	7 88502 20175 9	1	35
3101429	7 88502 20176 6	1	35
3101431	7 88502 20169 8	4 set	35
3101441	7 88502 20264 0	1	5
3101447	7 88502 20265 7	1	5
3101450	7 88502 20308 1	1	5
3101521	7 88502 20166 7	1	5
3101547	7 88502 20267 1	1	47
3101588	7 88502 201124	1	30
3101589	7 88502 201148	1	29, 30
3101590	7 88502 20167 4	1	16
3101612	7 88502 20185 8	1	17
3101627	7 88502 20149 0	1	29, 30
3101731	7 88502 20281 7	1	17
3101732	7 88502 20282 4	1	17
3101733	7 88502 20283 1	1	17
3101782	7 88502 20465 1	1	18
3101788	7 88502 20466 8	1	5
3101792	7 88502 20467 5	1	23
3101793	7 88502 20468 2	1	23
3101795	7 88502 20469 9	1	5
3101796	7 88502 20470 5	1	5
3101797	7 88502 20471 2	1	5
3101798	7 88502 20472 9	1	5
3101800	7 88502 20473 6	1	5
3101801	7 88502 20474 3	1	5
3101802	7 88502 20475 0	1	5
3101803	7 8850220476 7	1	5
3101804	7 88502 204774	1	5
3101882	7 8850220478 1	1	5
375L	7 88502 14100 0	1	32
376S	7 88502 14101 7	1	32
4102056	7 88502 20171 1	1	48
4102057	7 88502 20172 8	1 set	53
4102100	7 88502 20170 4	1	48
4800J-20	7 88502 19043 5	1	16
4800S-12	7 88502 00810 5	1	2
4800S-18	7 88502 00818 1	1	2
4800S-24	7 88502 00819 8	1	2
4800S-36	7 88502 00823 5	1	2
4800S-48	7 88502 00813 6	1	2
4800S-60	7 88502 00814 3	1	2
500L	7 88502 14110 9	1	32
501S	7 88502 14111 6	1	32
540-2-1/2	7 88502 20054 7	6	45
540-3	7 88502 20055 4	6	45

Catalog number	UPC	Case qty.	Page no.
540-4	7 88502 20056 1	6	45
540-5	7 88502 20061 5	6	45
540-6	7 88502 20057 8	6	45
540-8	7 88502 20058 5	1	45
540-10	7 88502 20059 2	1	45
540-12	7 88502 20060 8	1	45
540-14	7 88502 20062 2	1	45
625L	7 88502 14120 8	1	32
626S	7 88502 14121 5	1	32
660-S8	7 88502 20012 7	10	1
660-S12	7 88502 20013 4	10	1
660-S18	7 88502 20014 1	10	1
7200S-12	7 88502 00820 4	1	2
7200S-18	7 88502 00824 2	1	2
7200S-36	7 88502 00825 9	1	2
750L	7 88502 14130 7	1	32
751S	7 88502 14131 4	1	32
8500HPC-14	7 88502 00852 5	1	2
9000001	0 91162 00857 7	1	56
9000002	0 91162 00858 4	1	56
9040001	0 91162 00850 8	1	56
9040002	0 91162 00851 5	1	56
9040003	0 91162 00852 2	1	56
9040004	0 91162 00853 9	1	56
9040005	0 91162 00854 6	1	56
9044001	0 91162 00856 0	1	56
9045001	0 91162 00855 3	1	56
9050002	0 91162 00841 6	1	56
9050003	0 91162 00842 3	1	56
9050004	0 91162 00843 0	1	56
9050005	0 91162 00844 7	1	56
9050006	0 91162 00864 5	1	56
9060002	0 91162 00846 1	1	56
9060003	0 91162 00847 8	1	56
9060004	0 91162 00848 5	1	56
9060006	0 91162 00865 2	1	56
9060007	0 91162 00866 9	1	56
A94	7 85401 20128 6	4	72
A9114	7 85401 20004 3	24	72
A9455	7 85401 20016 6	12	72
AV2	0 91162 00139 4	12	52
B-102	7 88502 02062 6	1	44
B-103	7 88502 02063 3	1	44
B-104	7 88502 02064 0	1	44
B-106	7 88502 02065 7	1	44
B-108	7 88502 02066 4	1	44
B-110	7 88502 02067 1	1	44
B-112	7 88502 02068 8	1	44
B-EC3	0 91162 00818 8	3	48
B-HS0	7 88502 02071 8	1	44
B-HS1	7 88502 02072 5	1	44
B-HS1.5	7 88502 02073 2	1	44
B-HS2	7 88502 02074 9	1	44
B-HS3	7 88502 02075 6	1	44
B-HS4	7 88502 02076 3	1	44
B-HS5	7 88502 02077 0	1	44



Catalog number	UPC	Case qty.	Page no.
B-HS6	7 88502 02078 7	1	44
B-HS8	7 88502 02079 4	1	44
B-HS10	7 88502 02080 0	1	44
B-HS12	7 88502 02081 7	1	44
BAS-C9-4	7 88502 00870 9	1	35
BAS-C10-6	7 88502 00871 6	1	35
BAS-CB9-4	7 88502 00873 0	1	35
BAS-CB10-6	7 88502 00874 7	1	35
BASO	7 88502 00876 1	1	35
BC 34	7 88502 16055 1	1	60
BC 1	7 88502 16056 8	1	60
BC 1 1/4	7 88502 16057 5	1	60
BC 2	7 88502 16058 2	1	60
BC 3	7 88502 16059 9	1	60
BC 220V	7 88502 16000 1	1	59
BC 440V	7 88502 16010 0	1	59
BC 550V	7 88502 16020 9	1	59
BC on/off	7 88502 16291 3	1	60
BCRB	7 88502 16050 6	1	60
BCS 1	7 88502 16155 8	1	60
BCS 1 1/4	7 88502 16156 5	1	60
BCS 2	7 88502 16157 2	1	60
BCS 3	7 88502 16158 9	1	60
BCS 220	7 88502 16100 8	1	60
BCS 440	7 88502 16110 7	1	60
BCS 550	7 88502 16120 6	1	60
BDMS-1	7 88502 09030 8	1	63
BES8511	7 88502 203 555	3	50
BGP	0 91162 69012 3	1	14
BPC-H12	0 91162 00942 0	4	24
BPC-H12-PADS	7 88502 20346 3	12	24
BPC-H34	0 91162 00943 7	4	24
BPC-H34-PADS	7 88502 20347 0	12	24
BRG33	7 88502 20439 2	1	61
BS3N	7 88502 20237 4	1	33
BS4N	7 88502 20238 1	1	33
BS6N	7 88502 20239 8	1	33
BSG21-14	7 88502 20236 7	1	33
BTB20	7 88502 00561 6	1	53
BTB30	0 91162 69000 0	1	14
BTB30A	0 91162 69016 1	1	14
BV-CO30	0 91162 00836 2	1	56
BV-DF4SB	7 88502 20146 9	1	54
BV-DF5SB	7 88502 20147 6	1	54
BV-DF6SB	7 88502 20148 3	1	54
BV-DF8SB	7 88502 20235 0	1	54
BV-DP40	0 91162 00837 9	1	56
BV-HD40	0 91162 00831 7	1	55
BV-HD60	0 91162 00832 4	1	55
BV-HW45	0 91162 00834 8	1	55
BV-MPV5	0 91162 00833 1	1	55
BV-NVJ	0 91162 00839 3	5	56
BV-VB	0 91162 00835 5	1	56
BV-WV65	0 91162 00838 6	1	56
CDF402	7 88502 01460 1	1	45
CDF402CHV	7 88502 01497 7	1	45

Catalog number	UPC	Case qty.	Page no.
CDF403	7 88502 01461 8	1	45
CDF403CHV	7 88502 01498 4	1	45
CDF404	7 88502 01462 5	1	45
CDF404CHV	7 88502 01499 1	1	45
CDF406	7 88502 01463 2	1	45
CDF406CHV	7 88502 01501 1	1	45
CDF408	7 88502 01464 9	1	45
CDF408CHV	7 88502 01502 8	1	45
CDF410	7 88502 01465 6	1	45
CDF410CHV	7 88502 01503 5	1	45
CDF412	7 88502 01466 3	1	45
CDF412CHV	7 88502 01504 2	1	45
CDS24-10 WP	7 88502 00952 2	1	13
CDS24-12 WP	7 88502 00953 9	1	13
CDS24-20 WP	7 88502 00954 6	1	13
CL24	7 88502 20110 0	5	16
CLS-Shoe	7 88502 00830 3	2	16
CM10	0 91162 00026 7	24	46
CM15	0 91162 00028 1	24	46
CM20	0 91162 00029 8	16	46
CM22	0 91162 00030 4	18	46
CM25	0 91162 00031 1	18	46
CM30	0 91162 00032 8	12	46
CM34DR	0 91162 00038 0	6	46
CM40	0 91162 00033 5	9	46
CM50	0 91162 00034 2	9	46
CM60	0 91162 00035 9	6	46
CM80	0 91162 00036 6	6	46
CMS-1	7 88502 09040 7	6	63
D123S-SB	7 88502 01123 5	5	67
D15A-BE	7 88502 01131 0	10	66
D15AL-BE	7 88502 01132 7	10	66
D15S-BE	7 88502 01133 4	10	66
D15-SET	7 8850201136 5	1	66
D16	7 88502 01174 7	5	66
D16L	7 88502 01175 4	5	66
D16S	7 88502 01173 0	5	66
D16-SET	7 8850201135 8	1	66
D22A	7 88502 01111 2	5	67
D27AH-BE	7 88502 01151 8	1	67
D27AHL-BE	7 88502 01150 1	1	67
D29ASS-2	7 88502 01169 3	5	67
D29ASSL-2	7 88502 01170 9	5	67
D29SS-2	7 88502 01117 4	5	67
D29SSL-2	7 88502 01118 1	5	67
D39ASS-SB	7 88502 20336 4	5	65
D39ASSL-SB	7 88502 20334 0	5	65
D47	7 88502 01103 7	15	68
D48	7 88502 01104 4	10	68
D48A	0 91162 01100 3	10	68
D49	7 88502 01105 1	10	68
D50	7 88502 01108 2	10	69
D51A	7 88502 00046 8	10	69
D-BKAH	0 91162 009536	12	71
D-BKPH	0 91162 009543	12	70
DBKPHSET	0 91162 00977 2	8	70

Catalog number	UPC	Case qty.	Page no.
D-BKWH	0 91162 009550	12	71
DBST	7 88502 20092 9	8	71
DHBC-12	0 91162 00930 7	4	42
DHBC-24	0 91162 00931 4	4	42
DHBC-36	0 91162 00932 1	4	42
DHCC-4	0 91162 00933 8	6	46
DHCC-6	0 91162 00934 5	6	46
DT 2400-12	7 88502 00816 7	1	16
DT 2400-24	7 88502 00817 4	1	16
DUO16-8	0 91162 00044 1	6	28
DUO30-8	0 91162 00045 8	6	28
DUO45-8	0 91162 00046 5	6	28
DUO65-8	0 91162 00047 2	6	28
EHKMICRO	0 91162 00234 6	6	27
EHKM06	0 91162 00235 3	4	27
EHKM12	0 91162 00236 0	4	27
EHKL06	0 91162 00237 7	4	27
EHKL12	0 91162 00238 4	4	27
EHKL18	0 91162 00252 0	4	27
EHKL24	0 91162 00239 1	4	27
EHKL36	0 91162 00240 7	4	27
EHKXL06	0 91162 00246 9	4	27
EHKXL12	0 91162 00241 4	4	27
EHKXL18	0 91162 00253 7	4	27
EHKXL24	0 91162 00242 1	4	27
EHKXL36	0 91162 00243 8	4	27
EHKXL50	0 91162 00254 4	4	27
EKT-55	0 91162 00679 5	6	48
EZ15-6	7 88502 20286 2	1	28
EZ30-6	7 88502 20287 9	1	28
EZS15-8	7 88502 20021 9	6	28
EZS30-8	7 88502 20022 6	6	28
EZS45-8	7 88502 20023 3	6	28
EZS60-8	7 88502 20024 0	6	28
EZS90-8	7 88502 20053 0	6	28
FC24-8	7 88502 00990 4	5	34
GCS-CB	7 88502 20343 2	1	61
GCS-NCB	7 88502 20342 5	1	61
GK15	7 88502 20442 2	6	6
GK30	7 88502 20443 9	6	6
GK45	7 88502 20444 6	6	6
GK60	7 88502 20445 3	6	6
GS12-8K	7 88502 20090 5	10	4
GS16-12K	7 88502 20091 2	10	4
GS16K	7 88502 20070 7	10	4
GS20K	7 88502 20071 4	10	4
GS25K	7 88502 20072 1	10	4
GS30K	7 88502 20073 8	10	4
GS60K	7 88502 20075 2	5	4
GSCC2.5-PADS	7 88502 20421 7	4	41
GSCC2.506	0 91162 00959 8	4	41
GSCC2.512	0 91162 00960 4	4	41
GSCC2.518	0 91162 00961 1	6	41
GSCC2.524	0 91162 00962 8	4	41
GSCC2.530	0 91162 00963 5	6	41
GSCC2.536	0 91162 00964 2	4	41

# Index

Catalog number	UPC	Case qty.	Page no.
GSCC3.5-PADS	7 88502 20422 4	4	41, 42
GSCC3.506	0 91162 00965 9	6	41
GSCC3.506+2K	0 91162 00156 1	4	42
GSCC3.512	0 91162 00966 6	6	41
GSCC3.512+2K	0 91162 00157 8	4	42
GSCC3.518	0 91162 00967 3	6	41
GSCC3.518+2K	0 91162 00160 8	4	42
GSCC3.524	0 91162 00968 0	6	41
GSCC3.524+2K	0 91162 00158 5	4	42
GSCC3.530	0 91162 00969 7	4	41
GSCC3.530+2K	7 88502 20357 9	4	42
GSCC3.536	0 91162 00970 3	6	41
GSCC3.536+2K	0 91162 00159 2	4	42
GSCC4PK	0 91162 00161 5	1	42
GSCC5.012	0 91162 00972 7	6	41
GSCC5.018	0 91162 00973 4	6	41
GSCC5.024	0 91162 00974 1	6	41
GSH12	7 88502 20225 1	10	19
GSH20	7 88502 20227 5	10	19
GSH30	7 88502 20229 9	10	19
GSH50	7 88502 20231 2	5	19
GSL30	7 88502 20078 3	5	4
GSL60	7 88502 20079 0	5	4
GSM20	7 88502 20089 9	5	4
GSM25	7 88502 20080 6	5	4
GSM30	7 88502 20081 3	5	4
GSM40	7 88502 20082 0	5	4
GSM50	7 88502 20083 7	5	4
GSM60	7 88502 20084 4	5	4
GSV300M	7 88502 20163 6	1	17
GTR12	7 88502 20268 8	1	51
GTR16B6	7 88502 20269 5	1	51
GTR16S6H	7 88502 20270 1	1	51
GTR30B6	7 88502 20271 8	1	51
HH11C	7 88502 20435 4	1	60
HS-6	0 91162 00813 3	12	53
HS-8	0 91162 00814 0	6	53
HS-12	0 91162 00815 7	3	53
HT-14	7 88502 14720 0	12	72
HT-24	7 88502 14721 7	12	72
IBEAM24	7 88502 203 487	2	23
IBEAM30	7 88502 203 562	2	23
IBEAM36	7 88502 203 494	2	23
IBEAM48	7 88502 203 500	2	23
IBEAM60	7 88502 203 517	2	23
IBEAM72	7 88502 203 524	2	23
IBEAM84	7 88502 203 531	2	23
IBEAM96	7 88502 203 548	2	23
J18-8	7 88502 19030 5	10	15
JM-750	7 88502 18800 5	1	72
JM-1000	7 88502 18810 4	1	72
KBX20	0 91162 00810 2	12	9
KF2	0 91162 00104 2	1	48
KF4	0 91162 00105 9	1	48
KFP	0 91162 00107 3	1	53
KLI3.004	0 91162 00990 1	6	20

Catalog number	UPC	Case qty.	Page no.
KLI3.008	0 91162 00991 8	6	20
KLI3.012	0 91162 00992 5	6	20
KLI3.016	7 88502 20131 5	6	20
KP	0 91162 00665 8	4	9
KR-AS	0 91162 00642 9	12	9
KR-JP	0 91162 00639 9	12	9
KRE-EC	7 88502 20431 6	24	9
KRE-J2K	7 88502 20430 9	4	9
KRE-RPP	7 88502 20432 3	48	9
KRE-VO	7 88502 20429 3	12	9
KRE3512	7 88502 20373 9	2	7
KRE3518	7 88502 20418 7	2	7
KRE3524	7 88502 20374 6	2	7
KRE3531	7 88502 20375 3	2	7
KRE3540	7 88502 20376 0	2	7
KRE3550	7 88502 20377 7	2	7
KRE3560	7 88502 20378 4	2	7
KRE3582	7 88502 20379 1	2	7
KRE3598	7 88502 20380 7	2	7
KREK2440	7 88502 20425 5	1 kit	9
KREK2450	7 88502 20426 2	1 kit	9
KREV40	7 88502 20381 4	2	8
KREV60	7 88502 20382 1	2	8
KREV78	7 88502 20383 8	2	8
KREV98	7 88502 20384 5	2	8
KREX2440	7 88502 20427 9	1 kit	9
KREX2450	7 88502 20428 6	1 kit	9
KRJR-12	0 91162 00140 0	2	10
KRJR-18	0 91162 00141 7	2	10
KRJR-24	0 91162 00142 4	2	10
KRJR-36	0 91162 00143 1	2	10
KRJR-50	0 91162 00144 8	2	10
KT5-1CP	0 91162 00675 7	1	48
KT5-2	0 91162 00676 4	1	48
LC4	7 88502 20051 6	10	19
LC8	7 88502 20004 2	10	19
LC12	7 88502 20006 6	10	19
LC20	7 88502 20007 3	5	19
LC31	7 88502 20130 8	5	19
LHS10	0 91162 00817 1	3	53
LM-06	7 88502 14700 2	12	72
LM-12	7 88502 14701 9	12	72
LM-24	7 88502 14702 6	12	72
LM-48	7 88502 14703 3	12	72
LM2.004	0 91162 01300 7	12	11
LM2.006	0 91162 01301 4	10	11
LM2.008	0 91162 01302 1	10	11
LM2.012	0 91162 01303 8	10	11
LMU2.004	0 91162 01324 3	24	11
LMU2.006	0 91162 01325 0	24	11
LMU2.008	0 91162 01326 7	24	11
LS-16	7 88502 14730 9	12	72
MCL8	7 88502 20111 7	1	34
MGC-1	7 88502 09050 6	4	63
MGC-2	7 88502 09060 5	4	63
MMS-4	7 88502 00998 0	10	3

Catalog number	UPC	Case qty.	Page no.
MMS-8	7 88502 00999 7	6	3
MMS-12	7 88502 00996 6	10	3
MP-PV/PVH/SVH	7 88502 20332 6	1	58
MPU-1	7 88502 09088 9	1	63
MS-1	7 88502 09082 7	25	63
MSP-24	7 88502 09080 3	1	63
MW-1	7 88502 09070 4	1	63
OPT4	7 85401 40128 0	4	72
OPT455	7 85401 40016 0	12	72
PC12-2	7 88502 20288 6	4	24
PC12-2-PADS	7 88502 20344 9	6	24
PC34-2	7 88502 20289 3	4	24
PC34-2-PADS	7 88502 20345 6	6	24
PC-34DR	0 91162 00039 7	12	24
PC-34DR-PADS	7 88502 203 586	1	24
PG12	0 91162 02101 9	5	28
PG24	0 91162 02102 6	5	28
PS55	0 91162 02020 3	1	49
PS130	0 91162 00099 1	1	49
PV 14	7 88502 20319 7	1	58
PV 38	7 88502 20320 3	1	58
PV 916	7 88502 20321 0	1	58
PV 1316	7 88502 20322 7	1	58
PV 1916	7 88502 20323 4	1	58
PV2412	7 88502 20316 6	1	57
PVA	0 91162 01900 9	6	52
PVH 14	7 88502 20324 1	1	58
PVH 38	7 88502 20325 8	1	58
PVH 916	7 88502 20326 5	1	58
PVH 1316	7 88502 20327 2	1	58
PVH 1916	7 88502 20328 9	1	58
PVH3813	7 88502 20317 3	1	57
QRCC3	0 91162 00944 4	6	46
QRCC4	0 91162 00945 1	6	46
QRCC6	0 91162 00952 9	6	46
RSC-8	7 88502 00700 9	10	16
RSC-12	7 88502 00701 6	2	16
RSC-18	7 88502 00702 3	5	16
RSC-24	7 88502 00703 0	5	16
RT4	7 85401 30128 3	24	72
RT114	7 85401 30004 0	4	72
RT455	7 85401 30016 3	1	72
S-10	0 91162 05501 4	6	53
SC 34	7 88502 16256 2	1	60
SC 1 14	7 88502 16257 9	1	60
SC 2	7 88502 16258 6	1	60
SC 110D	7 88502 16201 1	1	59
SC 110V	7 88502 16200 5	1	59
SC 220V	7 88502 16202 9	1	59
SC on/off	7 88502 16290 6	1	60
SCRB	7 88502 16250 0	1	60
SG4	0 91162 05200 6	10	47
SG8	0 91162 05201 3	10	47
SG5-DR	7 88502 05213 9	10	47
SG24-PC	7 88502 05216 0	10	47
SG30VAD	7 88502 00545 6	6	16





Catalog number	UPC	Case qty.	Page no.
SGL-8	7 88502 29470 6	5	3
SGL-12	7 88502 29474 4	5	3
SGL-18	7 88502 29478 2	5	3
SGL-24	7 88502 29480 5	5	3
SQ-4	7 88502 01350 5	10	4
SQ-8	7 88502 01360 4	5	4
SQ-12	7 88502 01370 3	5	4
SQ-16	7 88502 01371 0	5	4
SQ-20	7 88502 01375 8	5	4
SQ-24	7 88502 01372 7	5	4
SLV40M	7 88502 20251 0	1	17
SLV100M	7 88502 20160 5	1	17
SLV150M	7 88502 20161 2	1	17
SLV200M	7 88502 20162 9	1	17
STB-12	7 88502 19060 2	1	4
STB-18	7 88502 19062 6	1	4
STB-24	7 88502 19061 9	1	4
STB-36	7 88502 19066 4	1	4
STC-HA20	7 88502 20143 8	6	30
STC-HH20	0 91162 14003 1	5	30
STC-HH50	0 91162 14000 0	5	30
STC-HH70	0 91162 14001 7	5	30
STC-HV20	7 88502 20142 1	6	30
STC-IHA15	7 88502 20145 2	6	29
STC-IHH15	0 91162 14006 2	5	29
STC-IHH25	0 91162 14002 4	5	29
STC-SET-T20	7 88502 20433 0	1	31
STC-VH20	7 88502 20233 6	6	29
STC-VH50	7 88502 20234 3	6	29
SV5020	7 88502 20436 1	1	58
SVH 9/16	7 88502 20329 6	1	58
SVH 1 3/16	7 88502 20330 2	1	58
SVH 2 3/8	7 88502 20331 9	1	58
SVH 2 3/4	7 88502 20440 8	1	58
SVH 3 1/8	7 88502 20441 5	1	58
SVH400	0 91162 02012 8	1	52
SVH400XL	0 91162 02014 2	5	52
SVH5020	7 88502 20436 1	1	58
SVH5223	7 88502 20318 0	1	57
SVH5223 230	7 88502 20438 5	1	57
SVH7931	7 88502 20437 8	1	58
SVH7931M	7 88502 20447 7	1	58
TB100	7 88502 20123 0	1	23
TB150	7 88502 20124 7	1	23
TB250	7 88502 20125 4	1	23
TC4.008	0 91162 00777 8	10	13
TC4.512	0 91162 00780 8	10	13
TC5.512	0 91162 00783 9	5	13
TC7.016	0 91162 00785 3	5	13
TG4.008	0 91162 00704 4	10	12
TG4.008+2K	0 91162 00906 2	10	11
TG4.012	0 91162 00751 8	3	12
TG4.012+2K	0 91162 00907 9	10	11
TG4.016	0 91162 00752 5	10	12
TG4.016+2K	0 91162 00908 6	10	11
TG4.024	0 91162 00753 2	3	12
TG4.024+2K	0 91162 00909 3	10	11

Catalog number	UPC	Case qty.	Page no.
TG4.512	0 91162 00703 7	10	12
TG4.512+2K	0 91162 00910 9	10	12
TG4.518+2K	0 91162 00911 6	10	12
TG4.524	0 91162 00757 0	5	12
TG4.524+2K	0 91162 00912 3	5	12
TG4.530+2K	0 91162 00913 0	5	12
TG4.540	0 91162 00759 4	3	12
TG4.540+2K	0 91162 00914 7	5	12
TG5.512	0 91162 00706 8	10	12
TG5.512+2K	0 91162 00915 4	10	12
TG5.518+2K	0 91162 00916 1	5	12
TG5.524	0 91162 00763 1	5	12
TG5.524+2K	0 91162 00917 8	5	12
TG7.016	0 91162 00707 5	5	12
TG7.016+2K	0 91162 00920 8	5	12
TG7.024	0 91162 00767 9	1	12
TG7.024+2K	0 91162 00921 5	1	12
TG7.048	0 91162 00770 9	1	12
TG7.048+2K	0 91162 00924 6	1	12
TGJ2.506	0 91162 00601 6	5	12
TGJ2.506+2K	0 91162 00900 0	5	11
TGJ2.512	0 91162 00602 3	5	12
TGJ2.512+2K	0 91162 00901 7	5	11
TGJ2.518	0 91162 00603 0	5	12
TGJ2.518+2K	0 91162 00902 4	5	11
TGJ2.524	0 91162 00604 7	5	12
TGJ2.524+2K	0 91162 00903 1	5	11
TGJ2.530	0 91162 00605 4	5	12
TGJ2.530+2K	0 91162 00904 8	5	11
TGJ2.536	0 91162 00606 1	5	12
TGJ2.536+2K	0 91162 00905 5	5	11
TGK4.516+2K	0 91162 00925 3	5	12
TGK4.524+2K	0 91162 00926 0	5	12
TGK4.540+2K	0 91162 00927 7	5	12
TGK4.550+2K	0 91162 00928 4	1	12
TGK4.579+2K	0 91162 00929 1	1	12
TK-6	0 91162 05502 1	1 pair	9, 22, 53
TPM	7 88502 20158 2	1	53
TPL	7 88502 20159 9	1	53
TW16-20-10-2K	7 88502 20276 3	1	38
TW16-20-10H	7 88502 20272 5	1	38
TW16-20-10K	7 88502 20274 9	1	38
TW16A-STC	7 88502 20280 0	1	39
TW16AW19	7 88502 20337 1	1	36
TW16AW20	7 88502 20366 1	1	36
TW16AW25	7 88502 23067 8	1	36
TW16AW30	7 88502 23068 5	1	36
TW16VAD	7 88502 20279 4	1	39
TW16X	7 88502 20285 5	1	40
TW28-30-12-2K	7 88502 20211 4	1	38
TW28-30-14-2K	7 88502 20212 1	1	38
TW28-30-12H	7 88502 20215 2	1	38
TW28-30-14H	7 88502 20216 9	1	38
TW28-30-12K	7 88502 20213 8	1	38
TW28-30-14K	7 88502 20214 5	1	38
TW28A-STC	7 88502 20222 0	1	39
TW28AV	7 88502 20278 7	1	40

Catalog number	UPC	Case qty.	Page no.
TW28GRS30-12	7 88502 20210 7	1	39
TW28H0	7 88502 20224 4	1	40
TW28VAD	7 88502 20220 6	2	39
TW28X	7 88502 20223 7	1	40
TWV28-30-12	7 88502 20209 1	1	39
TWV16-20-15-2K	7 88502 20277 0	1	37
TWV16-20-15H	7 88502 20273 2	1	37
TWV16-20-15K	7 88502 20275 6	1	37
TWV28-30-17-2K	7 88502 20217 6	1	37
TWV28-30-17H	7 88502 20219 0	1	37
TWV28-30-17K	7 88502 20218 3	1	37
TWVAD	7 88502 20221 3	2	39
UK3.006	0 91162 00668 9	6	10
UK3.012	0 91162 00669 6	6	10
UK3.024	0 91162 00671 9	6	10
VAC-6	0 91162 00570 5	5	43
VAD	7 88502 00730 6	1	5, 18
VAS-23+2K	0 91162 001554	2	43
VAS400	0 91162 00071 7	3	43
WMS-1	7 88502 09000 1	10	62
WMS-3	7 88502 09020 9	15	62
WMS-4	7 88502 09025 4	6	62
WMS-5	7 88502 09027 8	10	62
WMS-6	7 88502 00028 4	10	62
WMS-7	7 88502 00029 1	15	62
WS-1	0 91162 00040 3	2	22
WS-3+2K	0 91162 00154 7	3	22
WS-6	0 91162 00502 6	4	22
WSM-9	7 88502 00840 2	1	21
WSM-12	7 88502 00841 9	1	21
WVS-4	7 88502 00836 5	1	21
XC-14PC	0 91162 00939 0	4	26
XC1	0 91162 00054 0	96	26
XC2	0 91162 00050 2	10	26
XC3	0 91162 00051 9	10	26
XC5	0 91162 00052 6	10	26
XC7	0 91162 00053 3	10	26
XCL2	0 91162 00068 7	12	26
XCL2-Set	0 91162 00069 4	24	26
XCL5	0 91162 00070 0	8	26
XCRG2	0 91162 00198 1	6	26
XCRG4	0 91162 00199 8	4	26
XM3	0 91162 01001 3	48	26
XM3-B	0 91162 01017 4	48	26
XM3-NPT	0 11962 01013 6	48	26
XM5	0 91162 01002 0	24	26
XM5-B	0 91162 01018 1	24	26
XM5-NPT	0 11962 01014 3	24	26
XM7	0 91162 01003 7	6	26
XM7-B	0 91162 01019 8	8	26
XM7-NPT	0 91162 01015 0	6	26
XM10	0 91162 01004 4	6	26
XM10-NPT	7 88502 20359 3	6	26
XV5-100	0 91162 00049 6	6	25
XV5-170	0 91162 00073 1	12	25

# STC charts

## A Vertical toggle with open arm and horizontal base plate

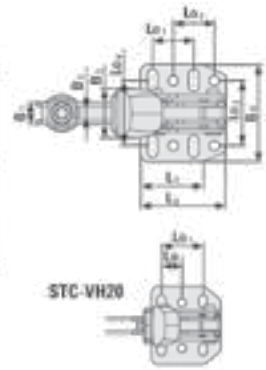
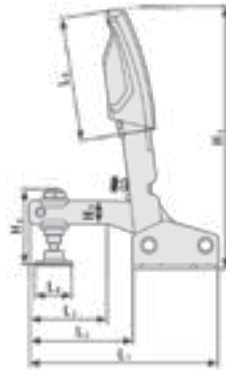

	Clamping Capacity	Automatic Adjust	Nominal Clamping Force Range	Holding Capacity	Approx. Weight
STC-VH20	13/16"	3/4"	25 - 250 lbs.*	450 lbs.	0.44 lbs.
STC-VH50	1 9/16"	1 3/8"	25 - 550 lbs.*	700 lbs.	0.94 lbs.
3101627	STC-VH20 Spindle service part set				
3101589	STC-VH50 Spindle service part set				

	Total length	Length of extension arm	Spindle adjustment range	Pressure plate diameter	Length of base	Length of base plate 1	Length of base plate 2	Length of 2-comp handle	Length of handle (open)	Height of handle (closed)	Height of handle (open)	Height of extension arm	Height of spindle, cpl.	Height of base	Width of extension arm (external)	Width of extension arm (internal)	Width of 2-comp. handle	Width of base plate	Length of hole spacing 1	Length of hole spacing 2	Length of hole spacing 3	Width of elongated hole	Diameter of hole
	L1	L2	L3	L4	L5	L6	L7	L8	L9	H1	H2	H3	H4	H5	B1	B2	B3	B4	Lo1	Lo2	Lo3	Lo4	Ø
STC-VH20	3.62"	1.97"	0.79"	0.63"	-	1.69"	1.38"	2.36"	4.84"	1.61"	3.94"	0.39"	1.65"	5.08"	0.39"	0.24"	0.94"	1.89"	1.02"	0.51"	1.10"	1.06-1.26"	0.22"
STC-VH50	4.57"	2.48"	1.57"	0.91"	-	2.09"	1.73"	2.99"	6.06"	2.05"	4.96"	0.55"	1.97"	6.38"	0.52"	0.32"	1.18"	2.36"	1.00"	1.00"	1.57"	1.30-1.89"	0.26"

## B Horizontal toggle with flanged base plate

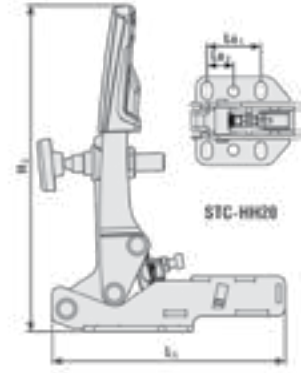
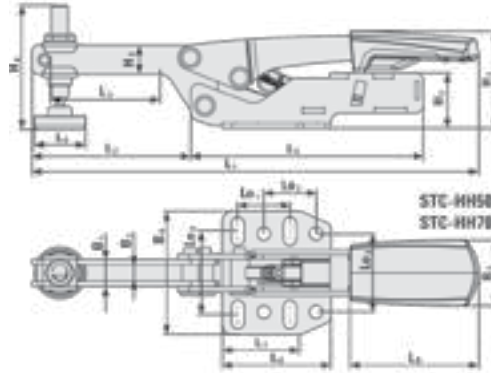

	Clamping Capacity	Automatic Adjust	Nominal Clamping Force Range	Holding Capacity	Approx. Weight
STC-HH20	13/16"	3/4"	25 - 250 lbs.*	450 lbs.	0.43 lbs.
STC-HH50	1 9/16"	1 3/8"	25 - 550 lbs.*	700 lbs.	0.81 lbs.
STC-HH70	2 3/8"	1 3/8"	25 - 550 lbs.*	700 lbs.	1.00 lbs.
3101627	STC-HH20 Spindle service part set				
3101589	STC-HH50 Spindle service part set				
3101588	STC-HH70 Spindle service part set				

	Total length	Length of extension arm	Spindle adjustment range	Pressure plate diameter	Length of base	Length of base plate 1	Length of base plate 2	Length of 2-comp handle	Height of handle (closed)	Height of handle (open)	Height of extension arm	Height of spindle, cpl.	Height of base	Width of extension arm (external)	Width of extension arm (internal)	Width of 2-comp. handle	Width of base plate	Length of hole spacing 1	Length of hole spacing 2	Length of hole spacing 3	Width of elongated hole	Diameter of hole
	L1	L2	L3	L4	L5	L6	L7	L8	H1	H2	H3	H4	H5	B1	B2	B3	B4	Lo1	Lo2	Lo3	Lo4	Ø
STC-HH20	6.57"	1.77"	0.79"	0.63"	3.27"	1.77"	1.38"	1.81"	1.73"	5.59"	0.39"	1.65"	0.98"	0.39"	0.24"	0.79"	1.65"	1.02"	0.51"	1.10"	1.02-1.25"	0.22"
STC-HH50	8.54"	3.03"	1.57"	0.91"	4.45"	2.09"	1.50"	2.83"	1.85"	6.22"	0.55"	1.97"	1.06"	0.51"	0.31"	1.26"	2.36"	1.00"	1.00"	1.50"	1.30-1.89"	0.26"
STC-HH70	8.54"	3.03"	1.57"	0.91"	4.45"	2.09"	1.50"	2.83"	2.52"	6.89"	0.55"	2.68"	1.73"	0.51"	0.31"	1.26"	2.36"	1.00"	1.00"	1.50"	1.30-1.89"	0.26"

## C Horizontal toggle with open arm and vertical base plate

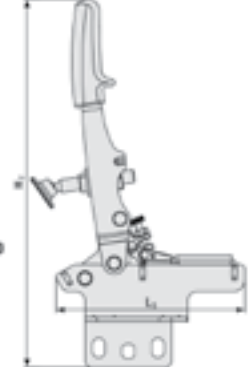
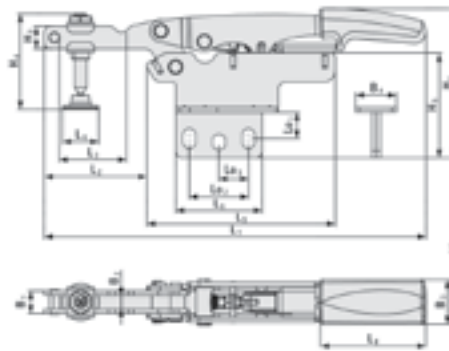

	Clamping Capacity	Automatic Adjust	Nominal Clamping Force Range	Holding Capacity	Approx. Weight
STC-HV20	13/16"	3/4"	25 - 250 lbs.*	450 lbs.	0.45 lbs.
3101627	STC-HV20 Spindle service part set				

	Total length	Length of extension arm	Spindle adjustment range	Pressure plate diameter	Length of base	Length of base plate 1	Length of base plate 2	Length of 2-comp handle	Height of handle (closed)	Height of handle (open)	Height of extension arm	Height of spindle, cpl.	Height of base	Width of extension arm (external)	Width of extension arm (internal)	Width of 2-comp. handle	Width of base plate	Length of hole spacing 1	Length of hole spacing 2	Length of hole spacing 3	Width of elongated hole	Diameter of hole
	L1	L2	L3	L4	L5	L6	L7	L8	H1	H2	H3	H4	H5	B1	B2	B3	B4	Lo1	Lo2	Lo3	Lo4	Ø
STC-HV20	6.57"	1.77"	0.79"	0.63"	3.27"	1.50"	-	1.81"	2.56"	6.38"	0.39"	1.65"	1.77"	0.39"	0.24"	0.79"	0.71"	0.39-0.51"	1.02"	0.51"	-	0.22"

\* Variable and dependent on spindle settings, pressure screw setting, force applied etc. Some small spindle adjustments may be required to achieve maximum clamping opening.

**D** Inline toggle with angled base plate

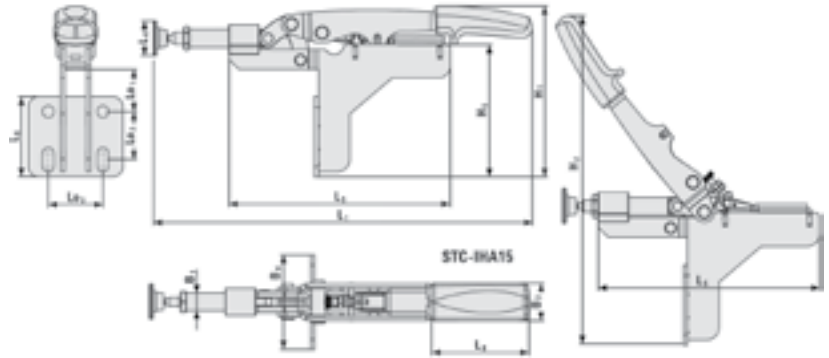

	Clamping Capacity	Automatic Adjust	Nominal Clamping Force Range	Holding Capacity	Approx. Weight
<b>STC-IHA15</b>	3/8"	5/16"	25 - 250 lbs.*	450 lbs.	0.48 lbs.
<b>3101627</b>	STC-IHA15 Spindle service part set				

	Total Length	Length of extension arm	Spindle adjustment range	Pressure plate diameter	Length of base	Length of base plate 1	Length of base plate 2	Length of 2-comp handle	Height of handle (closed)	Height of handle (open)	Height of extension arm	Height of spindle, cpl.	Height of base	Height to spindle centre	Width of extension arm (external)	Width of extension arm (internal)	Width of 2-comp. handle	Width of base plate	Length of hole spacing 1	Length of hole spacing 2	Length of hole spacing 3	Diameter of hole
	L1	L2	L3	L4	L5	L6	L7	L8	H1	H2	H3	H4	H5	H6	B1	B2	B3	B4	Lo1	Lo2	Lo3	Ø
STC-IHA15	7.13"	-	-	0.63"	4.13"	1.496"	-	1.81"	3.19"	5.87"	-	-	2.48"	1.37"	0.33"	-	0.79"	1.77"	0.81"	0.79-1.02"	1.125"	0.22"

**E** Horizontal toggle with open arm and angled base plate

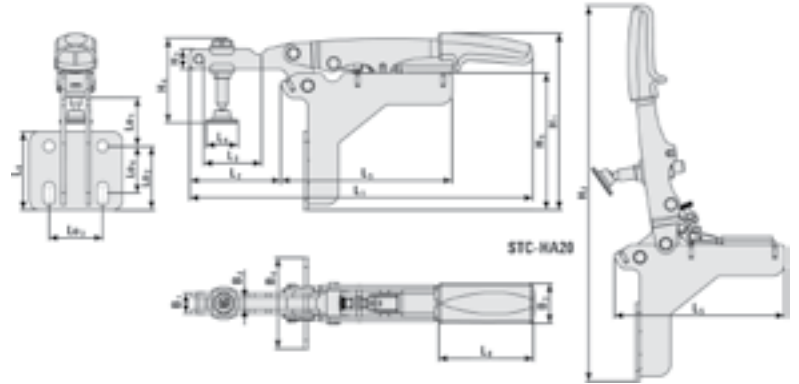
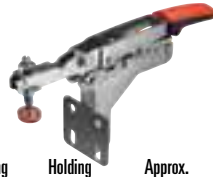

	Clamping Capacity	Automatic Adjust	Nominal Clamping Force Range	Holding Capacity	Approx. Weight
<b>STC-HA20</b>	13/16"	3/4"	25 - 250 lbs.*	450 lbs.	0.48 lbs.
<b>3101627</b>	STC-HA20 Spindle service part set				

	Total Length	Length of extension arm	Spindle adjustment range	Pressure plate diameter	Length of base	Length of base plate 1	Length of base plate 2	Length of 2-comp handle	Height of handle (closed)	Height of handle (open)	Height of extension arm	Height of spindle, cpl.	Height of base	Width of extension arm (external)	Width of extension arm (internal)	Width of 2-comp. handle	Width of base plate	Length of hole spacing 1	Length of hole spacing 2	Length of hole spacing 3	Width of elongated hole	Diameter of hole
	L1	L2	L3	L4	L5	L6	L7	L8	H1	H2	H3	H4	H5	B1	B2	B3	B4	Lo1	Lo2	Lo3	Lo4	Ø
STC-HA20	6.57"	1.77"	0.79"	0.63"	3.27"	1.50"	-	1.81"	3.35"	7.13"	0.39"	1.65"	2.60"	0.39"	0.24"	0.79"	1.77"	0.39-1.18"	0.79-1.02"	1.02"	-	0.22"

**F** Inline toggle with flanged base plate

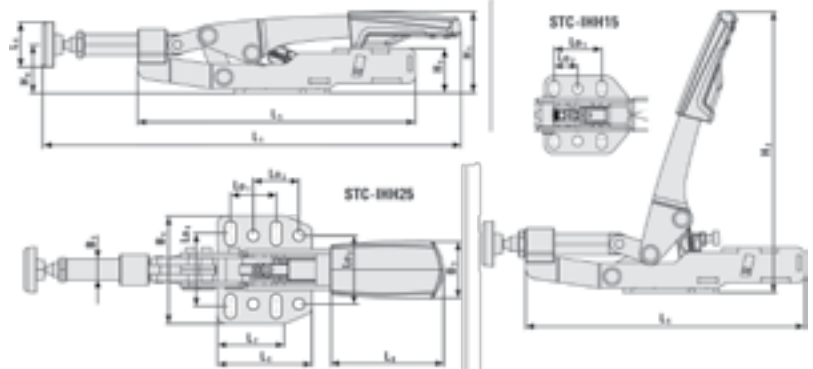

	Clamping Capacity	Automatic Adjust	Nominal Clamping Force Range	Holding Capacity	Approx. Weight
<b>STC-IHH15</b>	3/8"	5/16"	25 - 250 lbs.*	450 lbs.	0.41 lbs.
<b>STC-IHH25</b>	5/8"	1/2"	25 - 250 lbs.*	700 lbs.	0.88 lbs.
<b>3101627</b>	STC-IHH15 Spindle service part set				
<b>3101589</b>	STC-IHH25 Spindle service part set				

	Total Length	Length of extension arm	Spindle adjustment range	Pressure plate diameter	Length of base	Length of base plate 1	Length of base plate 2	Length of 2-comp handle	Height of handle (closed)	Height of handle (open)	Height of extension arm	Height of spindle, cpl.	Height of base	Height to spindle centre	Width of extension arm (external)	Width of extension arm (internal)	Width of 2-comp. handle	Width of base plate	Length of hole spacing 1	Length of hole spacing 2	Length of hole spacing 3	Width of elongated hole	Diameter of hole
	L1	L2	L3	L4	L5	L6	L7	L8	H1	H2	H3	H4	H5	H6	B1	B2	B3	B4	Lo1	Lo2	Lo3	Lo4	Ø
STC-IHH15	7.13"	-	-	0.63"	4.13"	1.77"	1.38"	1.81"	1.26"	4.21"	-	-	0.51"	0.63"	0.33"	-	0.79"	1.65"	1.02"	0.51"	1.10"	1.02-1.25"	0.22"
STC-IHH25	9.17"	-	-	0.91"	6.06"	2.09"	1.50"	2.87"	1.81"	6.10"	-	-	0.98"	1.06"	0.47"	-	1.26"	2.36"	1.00"	1.00"	1.50"	1.30-1.89"	0.26"





## Social media

### We're interactive.

- 1 Like us on Facebook to receive product announcements, contest alerts and more;
- 2 Follow us on Twitter for the most up-to-the-minute videos and product reviews;
- 3 View our extensive YouTube catalog of product and how-to videos to make your next job faster, safer, simply better.



## Customer service

### We're experienced.

- 1 Our customer service department has over 50 years of combined experience meeting the needs of our customers whether they are distributors or end-users;
- 2 We're here to answer the phone, listen to your concerns, deal with any problems and be helpful in any way possible. We're courteous, knowledgeable and will go the extra step;
- 3 If we can't help, we'll find you someone who can.



## Best practices

### We're here to help.

- 1 Use the right tool for the job – never use a clamp to lift, or use a cheater bar on a handle, or use pliers instead of a proper wrench – these mistakes can lead to accidents and injuries;
- 2 Use tools as recommended by the manufacturer – ie. never use cheaters on handles (this exerts greater force on the tool than it was designed for and is likely to cause breakage and possible injury).
- 3 Remove damaged or broken tools from service – clamps with broken pads, bent handles, corroded pads, snips with notched blades, bent clamps, damaged spindles etc. are unsafe and should be removed from service and either repaired or destroyed.

## 1 BESSEY General Cautions & Warnings

**PRICING:** Retail prices of our products can change at any time as they are impacted by a wide range of business factors (including transportation, staffing, local /regional taxes and other overhead expenses). Your distributor incurs these expenses in doing business in your community.

**PRODUCT INFORMATION:** BESSEY® Tools North America reserves the right to alter technical and physical specifications at any time. Some product specifications may vary from region to region to meet the requirements of the international marketplace. Errors and omissions excepted, BESSEY believes that to the best of its knowledge the product illustrations and descriptions provided in the current BESSEY catalog are accurate. However, such descriptions and illustrations are for the sole purpose of identification, and do not express or imply any warranty or condition that the products are merchantable or fit for a particular purpose or that the products will necessarily conform to the illustrations or descriptions. Our images include application shots which may include accessories and products not included with the product listed. The customer is solely responsible for reliance on, or use of, any information, and for the use or application of any product. BESSEY expressly disclaims any liability for direct, indirect, consequential or incidental damages in all events. In addition, all claims for damages, losses and causes of action shall be limited to the purchase price paid for the products in question. Note: "Clamping Force" or "Load Limit" is an estimation (nominal info.)

**CAUTION:** Clamping tools are not suitable for lifting, pulling or transporting. Improper use may lead to personal injuries or material damages. Clamping tools should only be clamped manually and without the use of any auxiliary tools or other devices. Please also see website for further information. Unless otherwise noted, clamping force ratings are generally presented as nominal figures for use in everyday situations and do not represent clamping force, nor should they be construed as precise figures.

**CAUTION:** Cutting Technology

Always wear appropriate protection including goggles and gloves while working. Sheared parts may injure workers and bystanders. Disconnect the power supply while working on electrical devices to avoid the risk of electric shock. Always ensure the cutting direction while using snips, knives and cutters is away from your body. Only use original replacement parts whenever required. Tools should only be used manually without using any auxiliary tools. Improper use may lead to personal injuries, material damages, personal injuries or even death. Please also see website for further information.

## 2 BESSEY Terms and Conditions - Distributor

**PRICING:** All prices, sizes and product specifications are subject to change without notice. Orders accepted only at price in effect at date of shipment.

**QUOTATIONS:** Quotations expire thirty days from date issued unless otherwise specified in writing.

**MINIMUM ORDER DOLLAR VALUE:** Minimum may be applied for finished goods and service parts. A service charge may be applied at the discretion of BESSEY Tools.

**FREIGHT TERMS:** All prices are F.O.B. (BESSEY). Prepaid shipping is based on minimum invoice values and, are subject to change without notice. Please contact BESSEY Tools North America for this information. All prepaid orders are shipped by ground transportation and using a provider of BESSEY's choice. If customers request another carrier, or another method of delivery, they must provide their own billing information in advance. Shipping errors must be reported within 10 days of product receipt.

**TERMS OF PAYMENT:** All orders are subject to BESSEY's credit approval and are due and payable thirty days (net) from the shipment date. Past due accounts are subject to interest at 1.5% per month (18% per annum).

**RETURN GOODS:** Products returned for credit will not be accepted. Goods are not returnable unless permission has previously been received in writing from our office. Returned goods are subject to the following conditions:

1. Incoming transportation charges, if not prepaid, will be deducted from credit memorandum.
2. All material returned must be found by BESSEY, upon arrival, to be in first class saleable condition. If not, the cost of putting it in such condition will be deducted from any credit memorandum.
3. A restocking charge of 20% plus an additional 2% per each month elapsed since date of purchase, of the original invoice cost, will be deducted from any credit memorandum.
4. Products returned must be current products in the BESSEY product offering.



# BESSEY® Resources



## 4 BESSEY® Return Procedures

**RETURN GOODS** – Purchased direct from a Tool Distributor: Please initiate returns of any sort with the distributor where the tool was purchased.

**RETURN GOODS** – Purchased direct from BESSEY®: Products purchased directly from BESSEY® which are returned for credit (only permitted if incorrectly shipped or if the product is found to be defective upon receipt), warranty or repair will not be accepted unless permission has previously been received in writing from our office. You may be asked for invoice numbers, packing slips or proof of delivery; please have this information ready.

Returned goods are subject to the following conditions:

1. Incoming transportation charges, if not prepaid, will be deducted from credit memorandum.
2. All material returned must be found by BESSEY®, upon arrival, to be in first class saleable condition. If not, the cost of putting it in such condition will be deducted from any credit memorandum.
3. A restocking charge of 20% plus an additional 2% per each month elapsed since date of purchase, of the original invoice cost, will be deducted from any credit memorandum.
4. Products returned must be current products in the BESSEY® product offering.

## 5 Calprop Statement (North America)

Proposition 65 (formally titled “The Safe Drinking Water and Toxic Enforcement Act of 1986”) is a California law that has been in effect since 1986 to promote clean drinking water and keep toxic substances that cause cancer and birth defects out of consumer products. It is administered by Cal/EPA’s California Office of Environmental Health Hazard Assessment (OEHHA). Proposition 65 regulates substances listed by California as causing cancer or birth defects or other reproductive harm in two ways. The first regulatory arm of Proposition 65 prohibits businesses from knowingly discharging listed substances into drinking water sources, or onto land where the substances can pass into drinking water sources. The second regulatory arm of Proposition 65 prohibits businesses from knowingly exposing individuals to listed substances without providing a clear and reasonable warning.

BESSEY® branded products do not, to the best of our knowledge, expose individuals to harmful substances as listed by the Cal Prop 65 Legislation.

## 6 BESSEY® History of James Morton

In 1985, BESSEY & Sohn appointed James Morton and American Clamping as exclusive distributor in North America. After nearly 20 years of successful business in North America the distributorship was purchased in 2003 by BESSEY® replacing the James Morton Inc. and American Clamping Corporation with a strategic BESSEY® operation.