

**BALDWIN**  
**FILTERS**



**Channel Flow®**

*Innovative Filtration Solutions*

## *Baldwin's Channel Flow Air Filters...*

# A Stronger Design For Outstanding Protection

### **Improved Engine Protection**

Design traps contaminants within the filter, preventing them from being passed on to the engine.

### **Straight-Through Air Flow Pattern**

Reduces the amount of space, up to 50%, of traditional filters and allows for new installation possibilities.

### **Durable Frame**

The Channel Flow frame fully encloses the filter, protecting the media from damage during installation and preventing air from being drawn in through the sides of the filter.



### **Compact, Lightweight**

Allows for easier installation and service in tight, compact areas.

### **Environmentally Friendly**

Non-metal filter elements allow for easier, more environmentally friendly disposal and are fully incinerable.

## **Channel Flow Air Filters Meet High Performance Demands**

With the continued demand for higher performance engines, along with stricter emission regulations, leading construction and agricultural manufacturers are designing vehicles with more compact air intake systems. These innovative designs mean better performance, but have less installation space under the hood.

Baldwin Filters' patent pending Channel Flow® air filters provide superior filtration solutions in a lightweight, compact design for easy installation in less space. This new straight-through air flow technology not only allows for less installation space, but also offers manufacturers flexibility in design configuration.

### Stronger Media Pack

The flat and corrugated media — in either a rolled or stacked format — is inherently strong, eliminating the need for a centertube and wrapper used in traditional air filters.

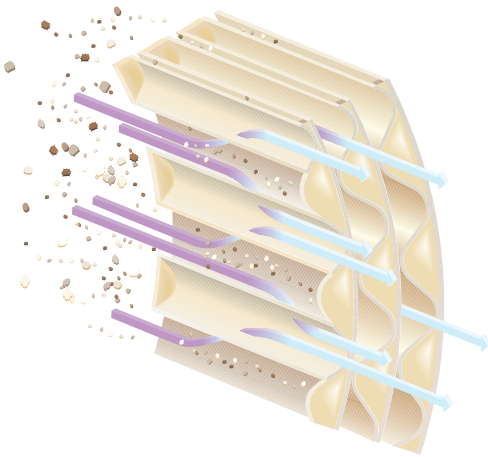

### Alternately Closed Channels

Air enters the open channels, trapping contaminants inside the filter and allowing clean air to flow through the filter media and out the open channels on the opposite end.

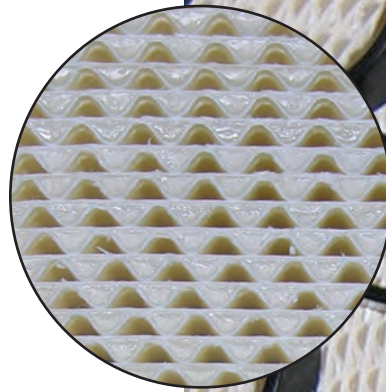

## Channel Flow vs. Traditional Filters

### More Surface Area

Baldwin's Channel Flow filter has more surface area than a traditional air filter, while requiring the same or less installation space. The Channel Flow media is formed by layering alternating rows of flat sheets and corrugated media. When completed, the media resembles a honeycomb network of channels. As the media pack is formed, alternating channels are sealed with a bead of adhesive. Air enters open channels and flows through the media and out through adjacent open channels.

### Increased Capacity

Traditional air filters have an average capacity of about 1 unit of contaminant per unit volume, where as the Channel Flow filter holds 2 units of contaminant per unit volume. This gives Channel Flow twice the capacity of traditional air filters.

### High Efficiency

Tests show Channel Flow filters have an average efficiency of 99.99%. This means for every 10,000 units of contaminant introduced to the filter, only one makes its way through. This is comparable to the efficiency of Baldwin Filters' traditional heavy-duty air filters.

### Decreased Flow Resistance

Increased air flow is needed for higher performance engines. Increased air flow is also needed to meet tougher exhaust emission standards. With a traditional air filter, air typically enters through the side of the filter housing. The air must then work its way around the filter element, pass through the media, then turn 90° to exit the filter. By eliminating the turns the air needs to make in a traditional air filter, in-line air filters reduce restriction.

### Stronger Media Support

Provides essential support when the pressure differential across the element increases due to moisture or contamination. Increased differential pressure can cause the element to "telescope," which can damage the filter.

# How Channel Flow Filters Work

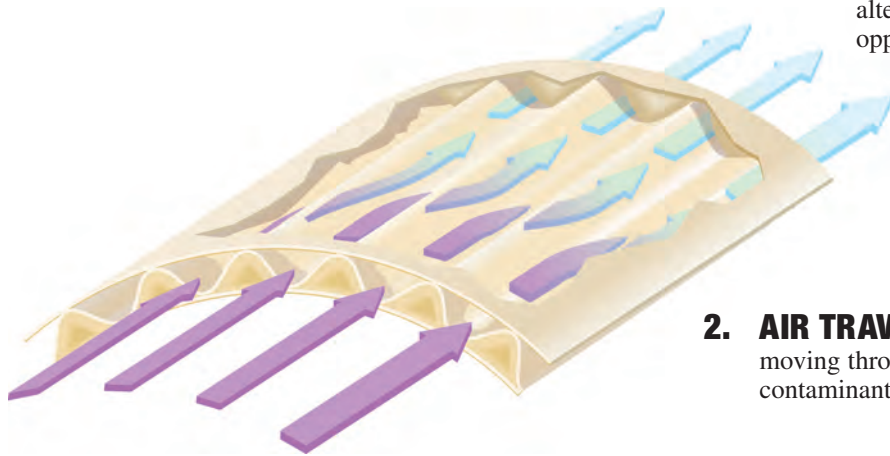

**1. DIRTY AIR** enters the Channel Flow filter through alternately opened channels on the intake side.

**2. AIR TRAVELS** toward the engine, moving through the media where contaminants are trapped.

**3. CLEAN AIR** exits the filter through alternately opened channels on the opposite end.

---

## How Baldwin Can Help You



Baldwin has been a leader in mobile filtration for over seventy years.

Baldwin's manufacturing operation is vertically integrated – meaning we manufacture nearly every component used in our filters.

Baldwin's team of engineers, using the latest technology in 3-D CAD modeling and stereo lithographic prototyping, continue to identify

innovative solutions for our customer's filtration needs.

Baldwin's state-of-the-art technical center performs extensive testing in the lab and in the field.

With the largest Sales Force in the industry, and Customer Service and Technical Support Groups on hand, Baldwin's team of professionals is here to assist you with all your needs.

# Channel Flow<sup>®</sup> Air Filters

- 1 Media Support**  
protects the media pack from changes caused by increases in differential pressure.
- 2 Media Pack Configuration**  
— in either a rolled or stacked format — is inherently strong, eliminating the need for a centertube and wrapper used in traditional air filters.
- 3 Durable Frame**  
provides improved engine protection by fully enclosing the filter, protecting the media from damage during handling and preventing air from being drawn in through the sides of the filter.
- 4 Non-Metal Filter Element**  
allows easier, more environmentally friendly disposal and is fully incinerable.
- 5 Stronger Seal Support**  
provides better sealing support and reduces the chance for leaks.

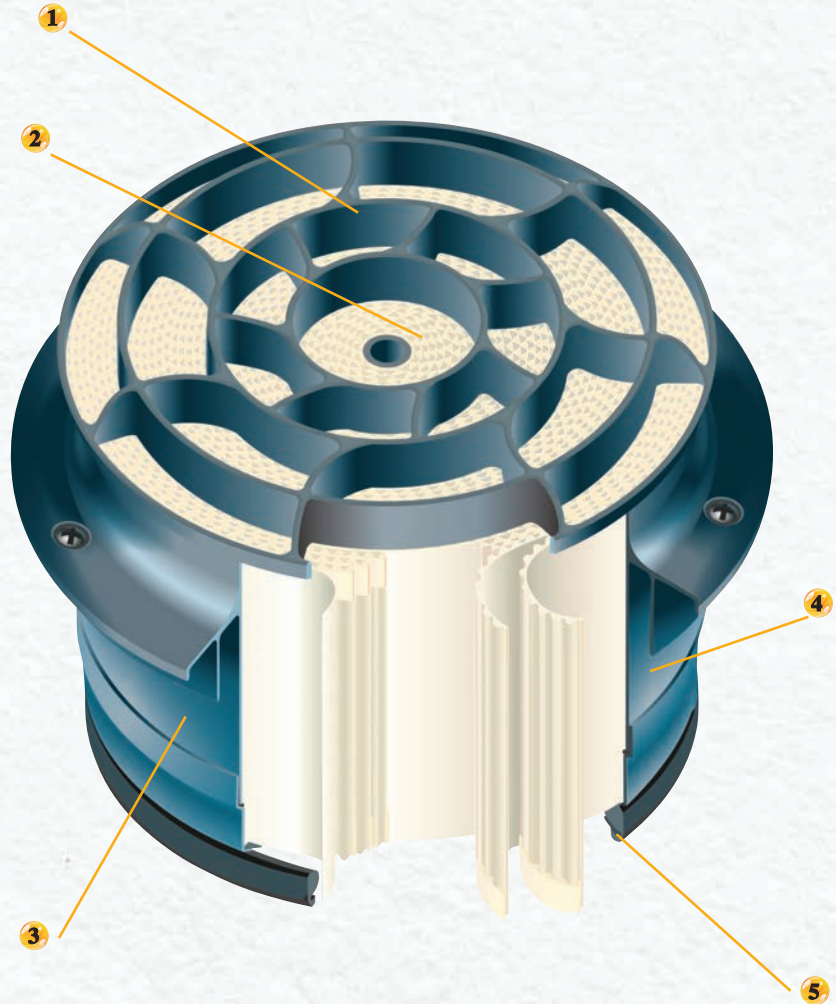

Baldwin Filters' broad, heavy-duty coverage includes Channel Flow air filters with innovative design features to protect your engine's air intake system. Baldwin's Channel Flow air filters mean pure performance, system protection and hours of trouble-free system operation.

# How Channel Flow Filters Work

## More Surface Area

The key to the Channel Flow filters is the element. Channel Flow media is formed by layering alternating rows of flat sheets and corrugated media. When completed, the media resembles a honeycomb network of channels. Elements can be formed in either a round or racetrack design. Alternating channels are sealed with a bead of adhesive as the media pack is formed.

Air enters an open channel on the inlet side and flows through the media and exits through an adjacent open channel. Contaminants remain trapped within the channels and won't dislodge during servicing.

## Capacity

Traditional air filters have an average capacity of about 1 unit of contaminant per unit volume, where as the Channel Flow filter holds 2 units of contaminant per unit volume. This gives Channel Flow twice the capacity of traditional air filters.

## Efficiency

Tests show Channel Flow filters have an average efficiency of 99.99%. This means for

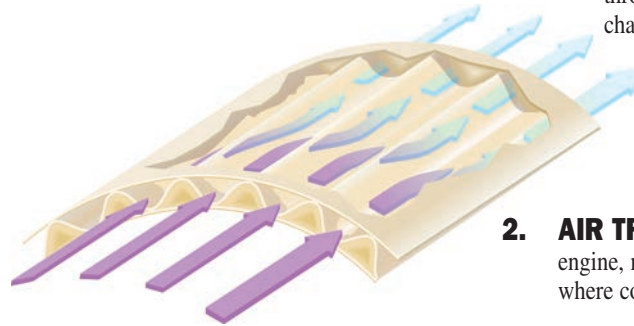

**1. DIRTY AIR** enters the Channel Flow filter through alternately opened channels on the intake side.

**2. AIR TRAVELS** toward the engine, moving through the media where contaminants are trapped.

**3. CLEAN AIR** exits the filter through alternately opened channels on the opposite end.

every 10,000 units of contaminant introduced to the filter, only one makes its way through. This is comparable to the efficiency of Baldwin Filters' traditional heavy-duty air filters.

## In-Line Flow Path

Along with additional components in the engine compartment, increased air flow is needed for higher performance engines.

Increased air flow is also needed to meet tougher exhaust emission standards.

With a traditional air filter, air typically enters through the side of the filter housing. The air must then work its way around the filter element, pass through the media, then turn 90° to exit the filter. By eliminating the turns the air needs to make in a traditional air filter, in-line air filters reduce air flow restriction.

## Baldwin vs. Leading Competitor

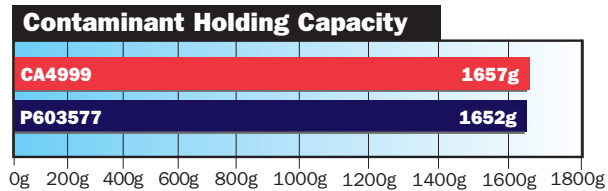
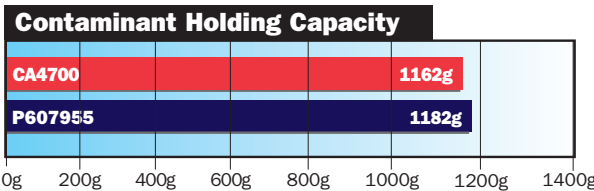
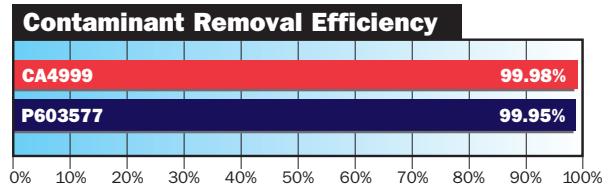
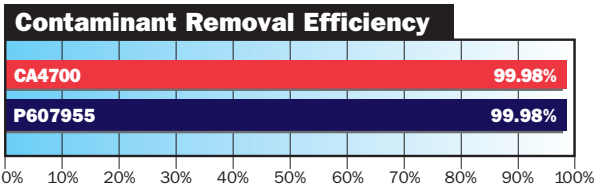

ISO 5011 Test: Flow Rate 565 SCFM, ISO Fine Test Dust, Termination at 30" of Water

ISO 5011 Test: Flow Rate 430 SCFM, ISO Fine Test Dust, Termination at 30" of Water

*Performance*



**PURE**  
*Performance*

**BALDWIN**  
**FILTERS**®

a CLARCOR company





## *Clean air provides superior performance*

Air is necessary for successful combustion in your engine. In fact, for efficient combustion, a modern diesel engine requires several thousand times as much air as it does fuel. Clean air — air almost 100% pure — is critical to engine survival and vital to its performance.

If you add a turbocharger to your engine, you may need to make changes to the intake ducting. Turbocharged engines require even more free-flowing clean air, 750 cubic feet per minute (21 cubic meters per minute) or more. Naturally aspirated engines demand about 20% less, but still these engines can require up to 15,000 gallons (67,000 liters) of air for every gallon (liter) of fuel.

In either case the induction system (ducting, hoses and reducers) brings outside air to the engine.

- The system should have enough intake capacity to meet engine requirements for air flow, avoiding sharp bends or constrictive ducting.
- It should be installed in a clean location, away from exhaust flow, road grime and splash.
- It should be vented to remove airborne moisture.

Air may flow into the engine through a series of components:

- an air-inlet hood to eliminate moisture.
- a pre-cleaner that will typically remove 80% to 90% of all airborne contaminants.
- an air filter housing.
- an ancillary transfer ducting.





## Baldwin: The Basis of Air Filtration

Three factors determine the proper size of the air filter to be installed:

- the amount of air flow required for efficient combustion.
- the amount of restriction (resistance to air flow) caused by the filter.
- the amount of dirt the filter will need to hold to allow for a reasonable change interval.



Nearly all filters use pleated cellulose (paper) media. Different formulations of cellulose, resins and chemical additives meet specialized needs for nonflammability, for example, or for moisture resistance. The pleats in Baldwin air filters are strong, precisely separated and stabilized.

Baldwin uses two proven methods to separate and stabilize its pleated media.

- PermaPleat® — an embossing process that builds dividers between pleats to prevent bunching and to insure uniform air flow.
- Beading — a continuous bead of adhesive around the circumference of the filter's metal wrap, either inner or outer, locking the pleat tips in place and preventing movement.

Most engine manufacturers specify minimum initial efficiency of at least 98.5%. On first reading, this figure seems very high. Remember though, that dirt in any amount can be harmful to your engine.

PURE PERFORMANCE: TESTED TIME & AGAIN

## Pure Performance: tested time & again

ISO 5011, the industry standard for air filtration, determines the rating for all Baldwin air filters. Per this ISO spec, the most commonly reported data addresses longevity and efficiency.

Baldwin air filters mean pure performance, delivering the clean air that powers your engine now and extends its useful life thousands and thousands of miles down the road.

### Baldwin vs. Leading Competitor

#### CONTAMINANT REMOVAL EFFICIENCY

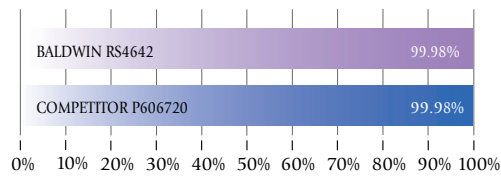

#### CONTAMINANT HOLDING CAPACITY

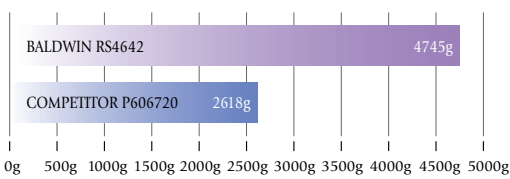

ISO 5011 Test: Flow Rate 1235 SCFM, ISO Fine Test Dust, Termination at 30" of water.

### Baldwin vs. Leading Competitor

#### CONTAMINANT REMOVAL EFFICIENCY

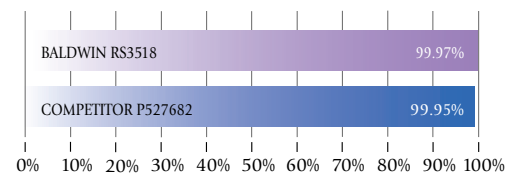

#### CONTAMINANT HOLDING CAPACITY

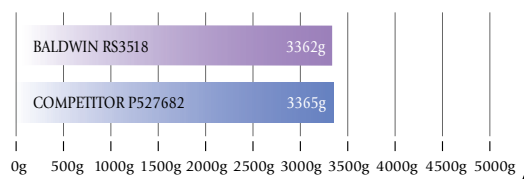

ISO 5011 Test: Flow Rate 1325 SCFM, ISO Fine Test Dust, Termination at 30" of water.

## Maximum efficiency, mile after mile

Most Baldwin heavy-duty air filters have minimum *initial* efficiencies approaching 99%.

Then, as dirt particles begin to accumulate in the filter media, those particles decrease the size of the media's openings, making it more difficult for even the smallest particles to pass through. As a result, the media's efficiency has actually been *increased*.

- **Heavy-Duty Primary Media** routinely achieve initial efficiencies of 98.5% and higher; as the filter loads with dirt, the accumulative efficiency of the media is normally 99.9% or higher.
- **Heavy-Duty Secondary Media** typically achieve an accumulative efficiency of 85% to 98%.

Engine manufacturers also specify the "maximum allowable initial restriction." Baldwin filters meet all these manufacturers' requirements.



## Air Filter Elements Establish Barrier



The Air Filter element establishes a barrier for the separation of airborne contaminants, allowing only clean air to enter the engine.

Baldwin air filter elements fall into several broad categories:

- **Automotive.** Both round and panel designs, with molded ends.
- **Axial Seal Primary.** Usually with metal ends, available in both PA (standard) and LL (long life) models.
- **Axial Seal Secondary.** Used to seal out dirt while the primary filter is being changed.
- **Radial Seal.** With molded ends and a reinforced closed end on filters with an inner diameter greater than 6" — characterized by ease of service.
- **Channel Flow.** Features a straight-through air flow pattern and design that traps contaminants within the filter.
- **Extreme Performance.** Features Protura® Nanofiber media for higher initial efficiency for greater engine protection and life and greater capacity for extended filter replacement intervals.





## *Servicing your air filter: why, when and how*

There are operational signs that an air filter has become completely plugged. The engine will begin to lose power and fuel consumption will increase. Black smoke may blow from the exhaust stack. Continued operation with a plugged air filter may very well damage the engine.

It's impossible to determine, just by looking, when air filters should be changed. An element that looks relatively clean may be almost totally plugged with ultra-fine particles from exhaust smoke or air pollutants.

On the other hand, a filter that looks dirty may still have many hours of useful life. Remember, that until maximum acceptable restriction is reached, the accumulation of dirt in the filter actually adds to its efficiency.

## *A better way*

Baldwin recommends the use of restriction gauges as an integral part of your filter maintenance program. Now standard on many different types of equipment, these gauges measure the amount of vacuum created when air is pulled through the filter, measuring the buildup of dirt from a new filter's installation throughout its useful life. (Check the manufacturer's recommendations for each engine.)

If you're not currently using restriction gauges, you really should reconsider. A typical gauge costs less than a new filter element. The payback is immediate:

- Fewer filter servicings and reduced labor costs.
- Reduced risk of damage from over-servicing.
- Less downtime and longer engine life.

## *Learning from your old filters*

Before disposing of old air filters, always inspect them carefully. Their appearance will tell you much about the performance of an entire air induction system.

- An accumulation of black, oily soot might mean that the air intake is located too close to the exhaust. Consider relocation.
- An accumulation of dirt on the clean side of the filter element might indicate a split in the filter media. Also, determine if the end seal is being bypassed or if a gasket is leaking. Do not attempt to reuse the filter.
- Rust on the filter's metal parts can mean that water is being drawn in with the air. Again, check the location of the intake. Insure that the water-venting ports in the induction system are clean and free of obstruction.



***An Important Caution:*** Baldwin does not recommend the cleaning of air filter elements. Since all contaminants cannot be removed, service intervals become progressively shorter. Further, the cleaning process might damage the filter, leading to engine damage as well.



*Baldwin Urethane Radial Seal Air Filters...  
Designed to meet or exceed OEM performance requirements*

- ❶ **Heavy-Duty Radial Seal Gasket and End Cap** formed from a special urethane compound, will not degrade under temperature extremes, changes in restriction or vibration.
- ❷ **Flexible Outer Edges** allow deflection for easy insertion and removal in housings which have minimal clearance.
- ❸ **PermaPleat® Construction** provides even pleat spacing to prevent bunching and ensure maximum element life.
- ❹ **Spiral Glue Binding** provides added pleat stability to optimize media effectiveness.

## *Baldwin Filters...known for Quality!*



Baldwin is the industry leader in heavy-duty filters. Our multi-million dollar research and testing facility anticipates an ever-increasing demand for filters that meet or exceed original equipment specifications.



Long before the industry adopted the philosophy, Total Quality Management guided our manufacturing and distribution processes. Baldwin continues to earn preferred vendor status, such as the TS 16949:2009 and ISO 9001:2008 certification.



We're committed to giving our customers the best products and services in the filter marketplace. It's a commitment based on continued engineering of our production facilities, ongoing training of our employees, and refinement of already sophisticated research operations.





# Radial Seal Air Housings

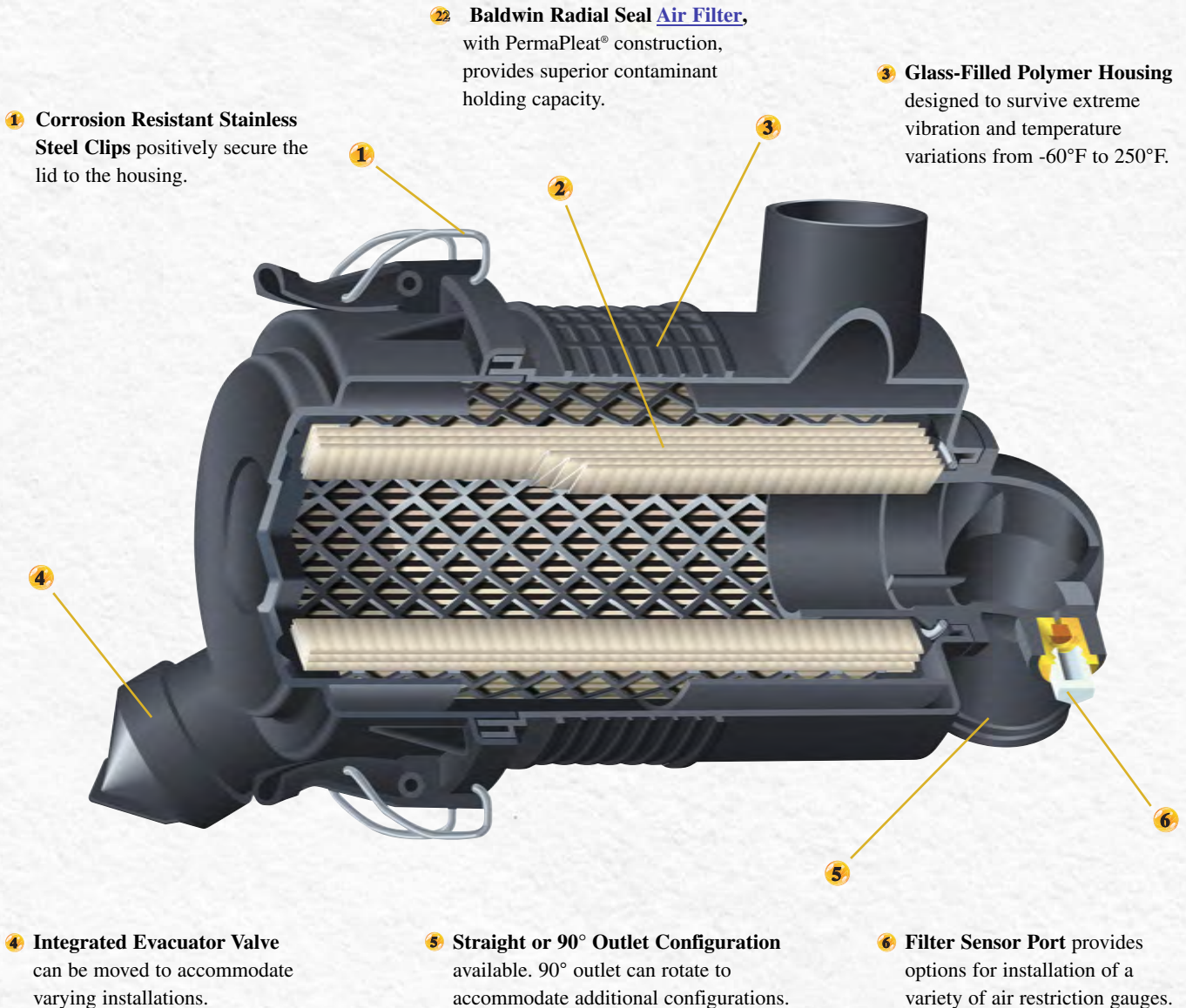

\* The HSG3077 housing has a 90° outlet. The HSG3078 housing has a straight outlet. The RS3715 filter comes with both the HSG3077 and HSG3078. Baldwin also offers an inner element (RS3930) and a mounting bracket (AB3349) for these products, sold separately.

ISO 5011 laboratory tests prove Baldwin's Radial Seal housings and air filters outperform competitor products. Unique design advantages not only improve strength and ease of service, but allow superior dust holding capacity as well. These advantages make Baldwin housings and air filters the best choice for popular applications.

# Baldwin's Radial Seal Housings Provide Superior Dust Holding Capacity Mile After Mile



90° Outlet Design



Straight Outlet Design

Baldwin Filter's goal is to design the best products available for the market. We now offer the same commitment to quality in Radial Seal housings designed to support applications requiring up to 75 cfm.

Baldwin's Radial Seal housings are constructed with a glass-filled polymer, which is designed to survive extreme vibration and temperature variations from -60°F to 250°F. The housings feature two-stage air filtration with a built-in

pre-cleaner, removing up to 70% of contaminants before they ever reach the primary air filter.

Both housings have a 5 1/2" O.D. and are 10 11/16" long with 1 3/4" inlet and outlet. These housings fit a variety of mounting options with straight or 90° outlet configuration. The 90° outlet rotates to accommodate additional mounting options.

Corrosion resistant, stainless steel clips positively secure the lid to the housing. A corrosion resistant mounting band is also available for use with these housings.

The evacuator valve is orientated at a 45° angle to support horizontal or vertical installations and can be moved to accommodate specific applications. An integrated sensor port provides the option to install a variety of air restriction gauges.

Baldwin offers both inner and outer filter elements to fit these housings. These filters feature a urethane compound used to bond the media pack, including the inner and out metal wrappers. The heavy-duty Radial Seal gasket formed from this urethane compound is designed to make servicing easier and more cost effective. The inner element is designed to protect the engine while the outer filter is being changed.

The Baldwin housing and filters provide superior dust holding capacity and contaminant removal efficiency for protection that outperforms the competition. Trust Baldwin Filters to provide you with clean air filtration solutions.

## Baldwin vs. Leading Competitor

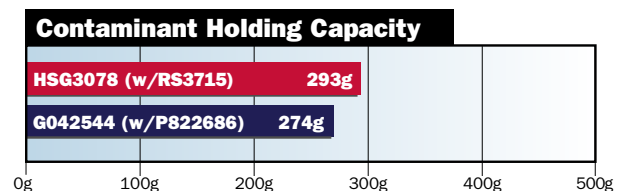
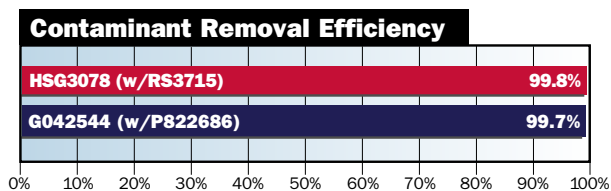

ISO 5011 Test: Flow Rate 75 SCFM, PTI Fine Test Dust, Termination at 30" of Water

# Radial Seal Air Filters

- ❶ **Heavy-Duty Radial Seal Gasket and End Cap**, formed from a special urethane compound, will not degrade under temperature extremes, changes in restriction or vibration.
- ❷ **Flexible Outer Edges** allow deflection for easy insertion and removal in housings which have minimal clearance.
- ❸ **PermaPleat® Construction** provides even pleat spacing to prevent bunching and ensure maximum element life.
- ❹ **Spiral Glue Binding** provides added pleat stability to optimize media effectiveness.

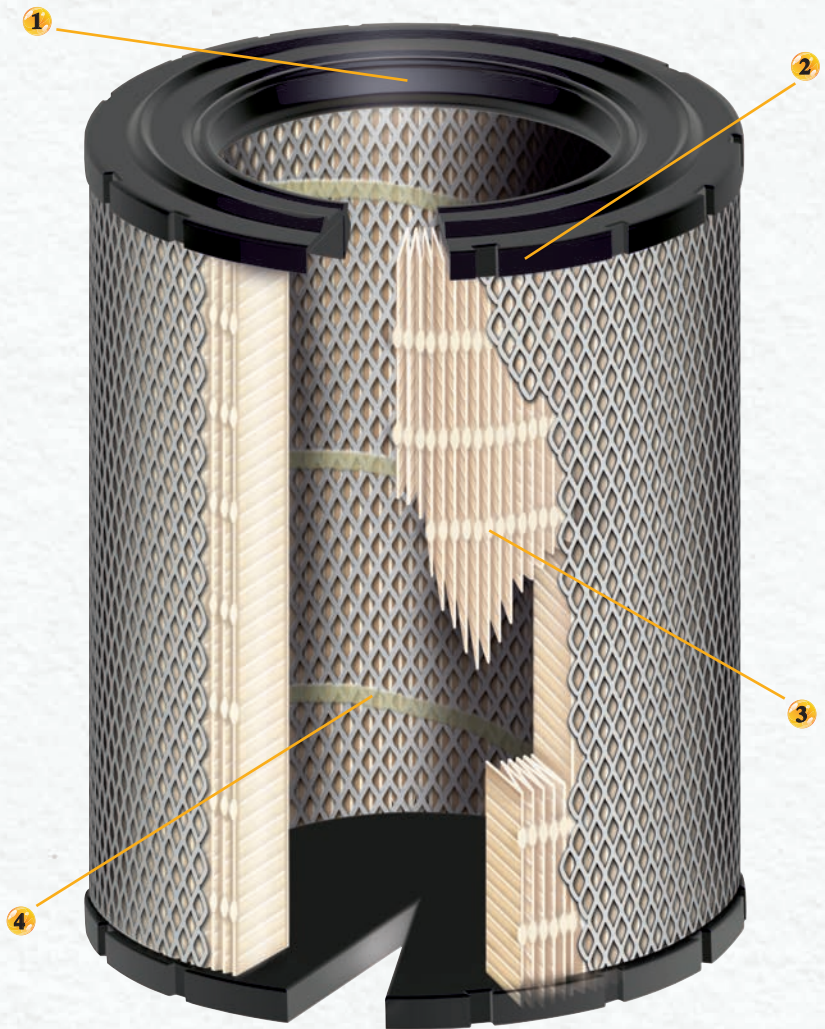

ISO 5011 laboratory tests prove Baldwin's Radial Seal air filters outperform other radial seal air filters. Unique design advantages not only improve strength and ease of service, but contaminant holding capacity and removal efficiency as well. These advantages make Baldwin Radial Seal air filters the best choice as the aftermarket replacement for popular applications.

**BALDWIN**  
**FILTERS**  
a CLARCOR company

# Baldwin's Radial Seal Filters Provide Maximum Efficiency Mile After Mile



In Baldwin's state-of-the-art technical center, air filters are tested against the industry standard of air filtration to insure quality and long lasting performance.

Every Baldwin air filter is designed to

have an efficient balance of three important characteristics – maximum efficiency, minimum initial restriction and cost-effective service life.

The primary components of a typical heavy-duty radial seal air filter are the seal, molded ends, inner and outer metal wrappers and the media.

The inner and outer metal wrappers protect the filter media and provide structural strength for the completed filter. With 73 percent of the surface area of all Baldwin metal wrappers open, minimal air flow restriction is attained.

The most important part of the air filter is the media. Baldwin ensures maximum strength and minimum restriction through its PermaPleat® design. PermaPleat is a special embossing process, which creates built-

in pleat spacing in the media. This adds extra stability and separation to prevent pleats bunching together from incoming air.

To complete the process of air filter construction, a urethane compound is used to form the molded ends. This urethane compound bonds the media pack, which includes the inner and outer metal wrappers, forming a strong, yet flexible package. The heavy-duty radial seal gasket formed from this urethane compound is designed to make servicing easier and more cost effective.

The end result of this process is an exceptional balance of filter durability, efficiency and capacity. Trust Baldwin Filters to provide you with clean air filtration solutions.

## Baldwin vs. Leading Competitor

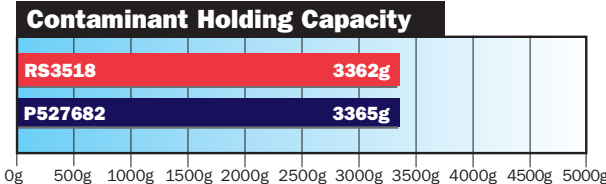
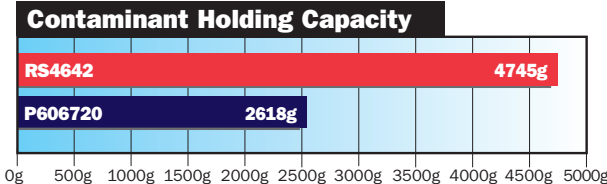
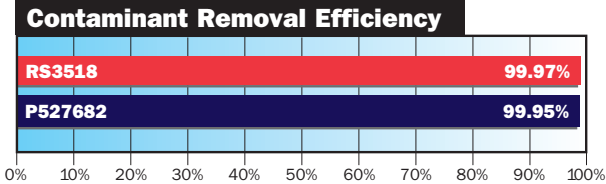
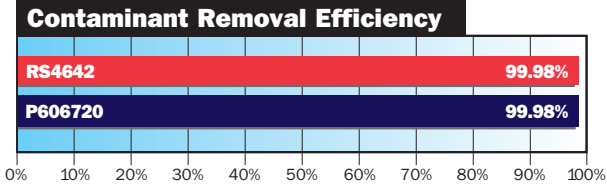

ISO 5011 Test: Flow Rate 1235 SCFM, ISO Fine Test Dust, Termination at 30" of Water

ISO 5011 Test: Flow Rate 1325 SCFM, ISO Fine Test Dust, Termination at 30" of Water