



MARINE
PRODUCTS
COLLECTION

2022

Your most trusted partner

Whether on water or on the road, delivering an optimal user experience is at the heart of ASG's business. It's why we are proud to be the world's leading supplier of products and integrated systems to the marine, RV, and Specialty Vehicle industries. Our broad portfolio of market leading brands in power management, digital control & monitoring, and networked devices are distributed globally to a diverse aftermarket and OEM customer base. ASG is driven, every day, to be the world's most trusted partner to the marine and mobile industries.

ANCOR

Wire
Wire Management

attwood

Lighting
Marine Accessories
Water and Fuel Systems

BEP
TRUSTED QUALITY

Battery Management
Power Distribution

BLUE SEA SYSTEMS

Battery Management
Circuit Protection
Power Distribution

G2ONE

Digital Control
& Monitoring
Onboard
Offboard UX

GARELICK™

Metal Fabricated
Hardware

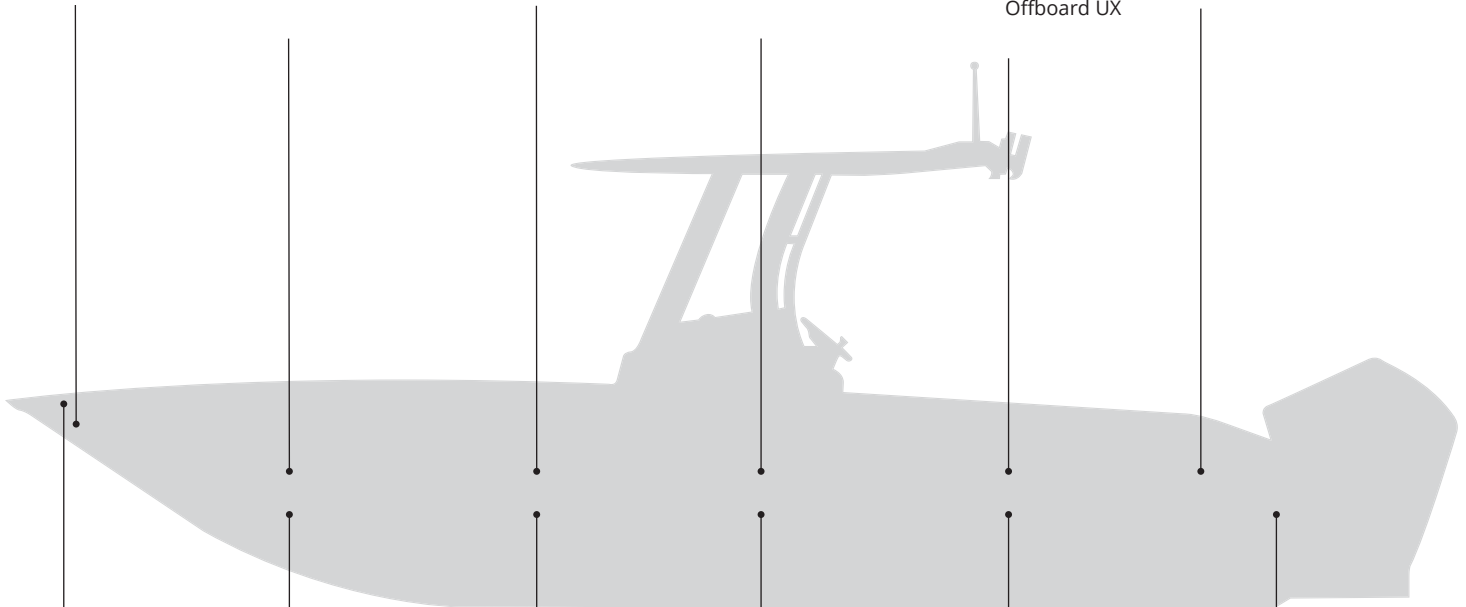

MotorGuide®

Trolling Motors

ProMariner™

Battery Chargers

Whale®

Heating Systems
Pumps

MARINCO

AC Shore Power
Marine Accessories

MASTERVOLT

Batteries
Power Conversion

LENCO

Actuators
Trim Tab System



What makes Attwood different:

Founder's Vision

Attwood has been a proven marine industry leader for over 100 years. Our wide range of products, including general marine accessories, seat & table hardware, and water systems & ventilation are tested to the highest USCG, ABYC, and CE standards. At Attwood, quality is our highest priority.

Innovation & Engineering

Attwood products are designed and tested to ensure performance and reliability.

Product Focus

Attwood is the leading supplier to OEM's in a majority of our categories, including general marine accessories, fuel systems, lighting, seat & table hardware, and water systems & ventilation.

Global Reach

A global distribution network provides convenient access to products when they are needed.

Industry Standards

Industry involvement ensures products meet industry safety & regulatory standards.

Trusted Quality

Highest quality products and systems you can trust.



NEW Products



12

Sahara Mk2 Automatic Bilge Pump

The easiest, most reliable automatic bilge pump ever designed.

Attwood is proud to introduce Sahara Mk2, the ONLY automatic bilge pump that eliminates air locks. What makes Sahara Mk2 so innovative is the patented X-Air™ Impeller. Its engineered performance forces air bubbles trapped in the hose and underside of the pump out of the pipework, so that the pump will not run dry and burn out. This breakthrough technology makes Sahara Mk2 the most reliable automatic bilge pump in freshwater AND saltwater applications.



16

Tsunami Mk2 Manual Bilge Pump

The easiest, most reliable manual bilge pump ever designed.

Attwood is proud to introduce Tsunami Mk2, the ONLY manual bilge pump that eliminates air locks. What makes Tsunami Mk2 so innovative is the patented X-Air™ Impeller. Its engineered performance forces air bubbles trapped in the hose and underside of the pump out of the pipework, so that the pump will not run dry and burn out. This breakthrough technology makes Tsunami Mk2 the most reliable manual bilge pump in freshwater applications.



POWER GUARD^{PRO}

129

PowerGuard PRO Battery Box

The only battery box designed with water resistant ventilation to better preserve your battery and protect those onboard.

Built upon the existing strengths of the PowerGuard 27 Series, the new PowerGuard PRO is designed with improvements that offer real value. Developed as a platform for boaters, anglers, and hobbyists alike; the new PowerGuard PRO sets the standard in battery box offerings.



Table of Contents

WATER SYSTEMS & VENTILATION

Bilge Pumps	12
Aerator Pumps	18
Bilge & Float Switches	20
Shower & Washdown Systems	22
Battery & Hand Operated Pumps	24
Pump Kits & Accessories	25
Plumbing System Fittings	27
Stainless Steel Thru-Hulls & Scupper Valves Fittings	28
Stainless Steel Capped Composite Thru-Hulls	31
Plastic Thru-Hulls & Scupper Valve Fittings	32
Drains, Drain Plugs & Tubes	33
In-Line Blowers	36
Vents & Collector Boxes	20



p. 12



p. 16



p. 18



p. 22



p. 24



p. 31



p. 35



p. 36



p. 37

LIGHTING

Navigation Overview	42
Deck Mount Sidelights	45
Pole Mounted Plug-In Sidelights	50
All-Round Plug-In Lights Overview	53
All-Round Plug-In Lights	54
All-Round Plug-In Bases	59
All-Round Fold-Down Lights	62
All-Round Fixed Base Lights	64
Anchor/Masthead Lights	65
Transom Lights	66
LED Portable Lighting	67
LED Docking Lights	68
LED Underwater Lights	69
LED Utility Lights	71
Lighting Accessories & Replacements	73



p. 45



p. 46



p. 50



p. 54



p. 59



p. 65



p. 66



p. 67



p. 70



p. 71

FUEL

Portable Fuel Systems Overview	76
Portable Fuel Tanks	77
Portable Fuel Components	78
Fuel Tanks & Hose Fittings	82
Integrated Fuel Systems Overview	84
Integrated Fuel Components	87
Accessories	93
Portable Fuel Components, International	96
Integrated Fuel Components, International	97



p. 77



p. 78



p. 79



p. 81



p. 83



p. 87



p. 89



p. 91



p. 98

Table of Contents

MARINE ACCESSORIES

Anchoring & Mooring Equipment	102
Marine Ropes & Cordage	108
Fishing Rod Holders & Accessories	115
Marine Maintenance Products	122
Interior & Boating Accessories	123
Electrical Accessories	129
Paddlesports & Accessories	137
Trailing Parts & Accessories	144



p. 102

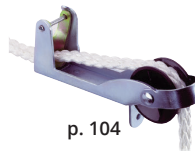

p. 104



p. 105



p. 109



p. 115



p. 111



p. 140



p. 125



p. 129



p. 144

HARDWARE

Cleats	156
Lift Rings	161
Hawse Pipes & Bow Eyes	162
Hooks	163
Water Ski Hardware	164
Bimini Style Convertible Top Accessories	166
Hinges	167
Hatch & Door Hardware	169
Hand Rails & Handles	171
Gas Springs & Accessories	172
Mounting Brackets	174



p. 156



p. 161



p. 162



p. 163



p. 164



p. 167



p. 169



p. 171



p. 172

SEATING SYSTEMS

Seat Types & ABYC Requirements	180
The Factors of Seating Comfort	181
Seating Offerings	182
Fishing Seats	184
Seating Systems	187
Pedestal Systems & Accessories	192



p. 184



p. 185



p. 192



p. 193

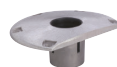

p. 196



p. 200



p. 203

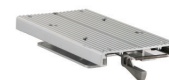

p. 204

APPENDIX & INDEX

Part Number Index	206
-------------------	-----

WATER SYSTEMS & VENTILATION

Bilge & Aerator Pumps



12

Atwood pumps are tested and approved as standard equipment by leading boat manufacturers. Bilge and aerator pumps are engineered for high performance, easy installation, and meet U.S. and International certificates and standards.

Shower & Washdown Systems



22

Complete shower sump pump systems deliver fast water flow into and out of the sump with easy installation. Meets or exceeds all applicable standards of the ABYC and USCG.

Pump Kits



25

Aerator and bilge pump kits are crafted to provide convenience, even while you are underway.

Accessories & Fittings



26

Required accessories and fittings that can be found within our pump kits or sold separately for easy replacement.



WATER SYSTEMS & VENTILATION

Thru-Hull & Scupper Valve Fittings

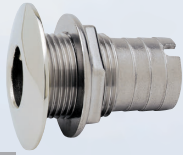

28

Backed by Attwood's trusted lifetime warranty, our easy to install thru-hulls and scupper valves are built with rugged stainless steel and a solid silicone gasket.

Drain & Drain Plugs



33

Durable hardware that you can rely on to provide bilge drainage when hauling out.

In-Line Blowers



36

Attwood in-line blowers provide ventilation for engine compartments, galleys, and bilges. Utilizing advanced fan blade design techniques, Attwood has developed a blower system that matches air flow of existing in-line blowers at a significantly reduced noise level.

Vents & Collector Boxes

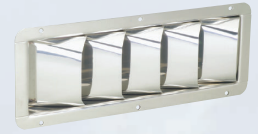

37

All collector boxes and vents are designed for intake or exhaust and meet ABYC H-2 requirements.

Complete Selection

A complete selection of pumps and blowers are available for fishing boats, runabouts, cruisers, yachts, and commercial boats. Attwood pumps and blowers are tested and approved as standard equipment by leading boat manufacturers.

Bilge and Aerator Pumps

The Heavy-Duty 1700 and 2000 bilge pumps have established Attwood into the commercial market with value-loaded industrial-duty features and performance.

The Tsunami series of cartridge style bilge and aerator pumps are engineered for higher performance in the most service friendly design imaginable. Their cartridge style allows quick and easy replacement without the need to remove hoses or mounting bases.

Automatic Bilge Pumps

All boats over 20' long with sleeping accommodations (excluding fold-out cockpit seats) should use automatic bilge pump systems. Non-automatic pumps drawing 12A or less can easily convert to automatic operation with Attwood Automatic Float Switches (page 21).

Our Sahara Series of automatic pumps range from 500 to 1200 GPH capacities.

Bilge pumps are designed to exhaust standing water only. They are not intended to prevent accumulation of on-board water due to rough weather, hull damage, and/or other unsafe navigational conditions. Note: Bilge and aerator pumps must be lower than the source of water for priming.

Turbo In-Line Blowers

Attwood offers ventilation equipment and accessories featuring the revolutionary, patented Turbo In-Line Blowers for 3"- and 4"-diameter systems. Turbo blowers are the most dependable, efficient, and powerful in-line blowers on the market, designed using aerospace technology. The Turbo line also features the industry's first water-resistant blower models, with durability proven in rigorous moisture tests and years of success in the field. Attwood offers Turbo water-resistant blowers with an unprecedented three-year limited warranty, and a one-year limited warranty for standard models.

Certification, Standards, and Listings - Pumps

All Attwood pumps meet or exceed the following U.S. and international certificates and standards:

- ABYC H-22
- ISO 8846, 8849 Marine
- U.S. Coast Guard Rule, Title 33CFR sections 183.410 and 33CFR 183.425
- NMMA "As Approved Listing"
- CE
- RCA
- All pumps are marine ignition protected



Certifications, Standards and Listings - Blowers

Attwood in-line blowers meet or exceed the following U.S. and international certificates and standards:

- ABYC-H2; ISO 9097
- U.S. Coast Guard Rules, Title 33 CFR sections 183.410, and 183.610 (b)
- Tested to ANSI/AMCA (210-85) and ANSI/ASHRAE (51-1985) standards
- NMMA "As Approved Listing"
- CE
- RCA

Choice of Electrical Connectors

Attwood pumps feature several wire attachment styles to adapt to your boat's wiring harness. Standard wire on all pumps are tinned and caulked 16-gauge for butt connection. All pumps ignition protected.

Special connectors are available on special order by contacting your Attwood representative. Minimum order quantity is 250.

- Packard Connector
- Packard Connector, Water-Resistant
- Amp Connector
- Amp Connector, Water-Resistant
- Deutsch Connector
- Quick Silver Connector
- Delphi Connector

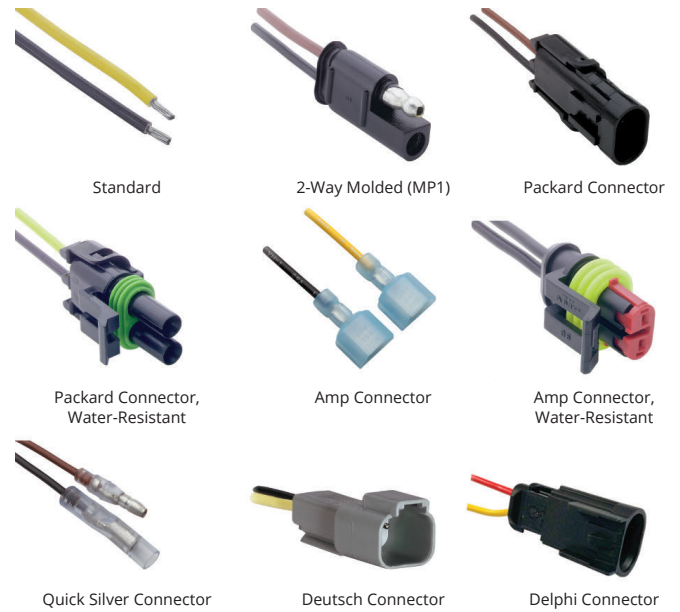

Brown – Positive, Black – Negative, Brown & White – Manual Override



Bilge Pumps



Automatic Bilge Pumps NEW

Sahara Mk2 is the only automatic bilge pump that eliminates air-locks

- Patented X-Air™ Impeller ejects trapped air in the pump and pipework.

Sahara Mk2 is the easiest automatic bilge pump to install and service

- External mounting feet and integrated outlet reduces time and effort.
- Universal mounting pattern makes replacement simple.
- Service pump cartridge from hard-to-reach areas using only one hand.

Sahara Mk2 is the most reliable automatic bilge pump in freshwater and saltwater applications

- Attwood's SteadySwitch™ reduces cycling and extends the life of the pump.
- 40% better protection against water ingress and electrolysis - vs. Mk1.
- 2X better protection against water ingress and electrolysis - than the leading competition.

Certifications, Standards and Listings

The Sahara Mk2 Automatic Bilge Pumps meet or exceed the following U.S. and international certificates and standards:

Bilge pumps standards

- ABYC H-22
- ISO 8849
- ISO 15083

Marine electrical wiring standards

- ABYC E-11
- ISO 10133
- U.S. Coast Guard Rule, 33CFR-183.425

Ignition protection standards

- ABYC C-1500
- ISO 8846 Marine
- U.S. Coast Guard Rule, 33CFR-183.410

Approvals

- NMMA "As approved listing"
- CE, RCM, UKCA

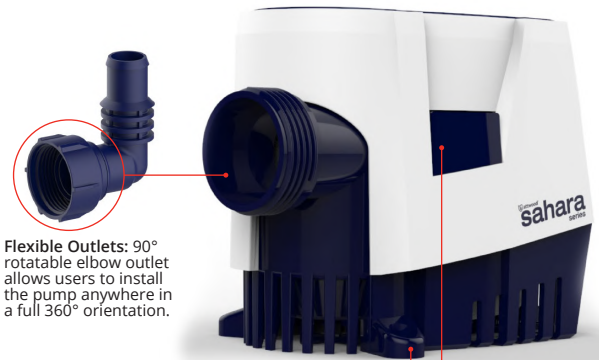

Exterior Mounting Feet: Eliminates the need to remove the basket, saving OEMs time on production lines.

Single-Hand Pump Cartridge Release: Convenient when trying to access a pump located in a hard-to-reach area of the boat's hull.

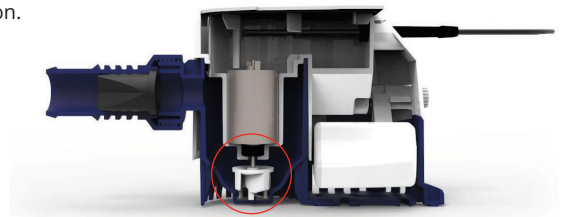

Patented X-Air™ Impeller: Prevents air locking so that the pump will not run dry and burn out.

Model No.	Rated Volts DC	Fuse Size	Outlet Type	Check Valve	Wire Length	OEM Part #	OEM Outlet Straight	OEM Outlet 90° Elbow	Part #	Service Kit
S500	12V	3A	3/4" (19mm) & 1" (25mm) Barbs	Y	29-1/2" (750mm)	—	—	—	5505-7	AK5505-7
	12V	3A	3/4" (19mm) Barb	N	29-1/2" (750mm)	5505-2	—	—	—	—
	12V	3A	1-3/8" Threaded*	Optional	29-1/2" (750mm)	5505-1	AS5505S-1	AS5505E-1	—	AK5505-7



Model No.	Rated Volts DC	Fuse Size	Outlet Type	Check Valve	Wire Length	OEM Part #	OEM Outlet Straight	OEM Outlet 90°	Part #	Service Kit
S800	12V	4A	3/4" (19mm) & 1" (25mm) Barbs	Y	29-1/2" (750mm)	—	—	—	5508-7	AK5505-7
	12V	4A	3/4" (19mm) Barb	N	29-1/2" (750mm)	5508-2	—	—	—	—
	12V	4A	1-3/8" Threaded*	Optional	29-1/2" (750mm)	5508-1	AS5505S-1	AS5505E-1	—	AK5505-7
S800	24V	2A	3/4" (19mm) & 1" (25mm) Barbs	Y	29-1/2" (750mm)	—	—	—	5509-7	AK5505-7
	24V	2A	3/4" (19mm) Barb	N	29-1/2" (750mm)	5509-2	—	—	—	—
	24V	2A	1-3/8" Threaded*	Optional	29-1/2" (750mm)	5509-1	AS5505S-1	AS5505E-1	—	AK5505-7



Model No.	Rated Volts DC	Fuse Size	Outlet Type	Check Valve	Wire Length	OEM Part #	OEM Outlet Straight	OEM Outlet 90°	Part #	Service Kit
S1200	12V	5A	1" (25mm) & 1-1/8" (28mm) Barbs	Y	29-1/2" (750mm)	—	—	—	5512-7	AK5512-7
	12V	5A	1-1/8" (28mm) Barb	N	29-1/2" (750mm)	5512-2	—	—	—	—
	12V	5A	1-3/8" Threaded*	Optional	29-1/2" (750mm)	5512-1	AS5512S-1	AS5512E-1	—	AK5512-7
S1200	24V	2A	1" (25mm) & 1-1/8" (28mm) Barbs	Y	29-1/2" (750mm)	—	—	—	5513-7	AK5512-7
	24V	2A	1-1/8" (28mm) Barb	N	29-1/2" (750mm)	5513-2	—	—	—	—
	24V	2A	1-3/8" Threaded*	Optional	29-1/2" (750mm)	5513-1	AS5512S-1	AS5512E-1	—	AK5512-7



* Must be used with appropriate Sahara outlet.

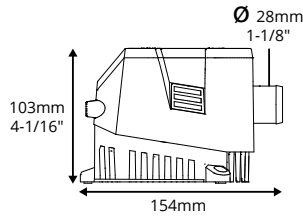
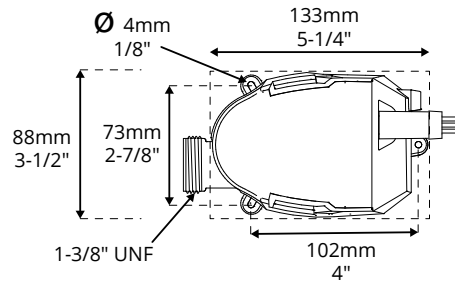

Sahara Mk2 1200 Barb

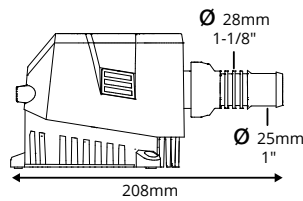

Sahara Mk2 1200 with Outlet - Straight

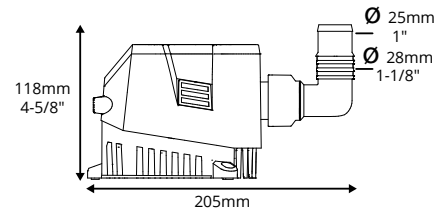

Sahara Mk2 1200 with Outlet - 90° Elbow

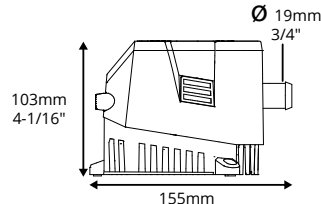

Sahara Mk2 500/800 Barb

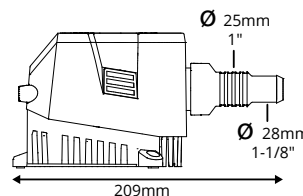

Sahara Mk2 500/800 with Outlet - Straight

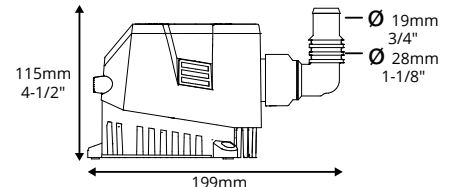

Sahara Mk2 500/800 with Outlet - 90° Elbow

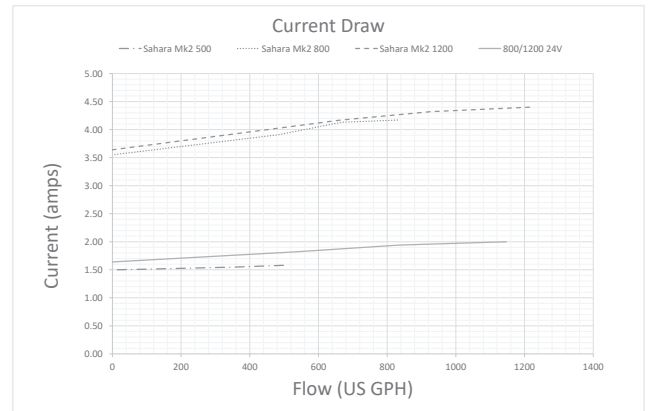
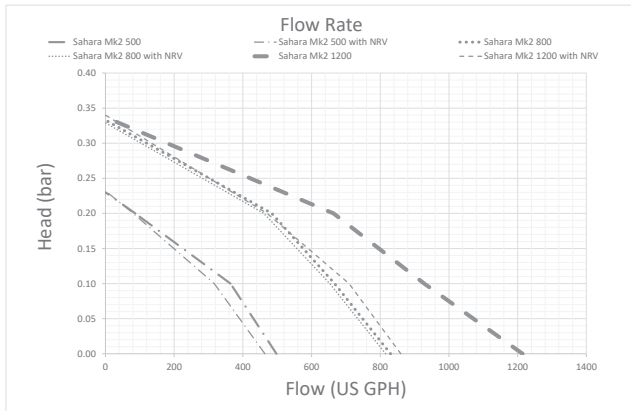

Mounting Pattern Compatibility

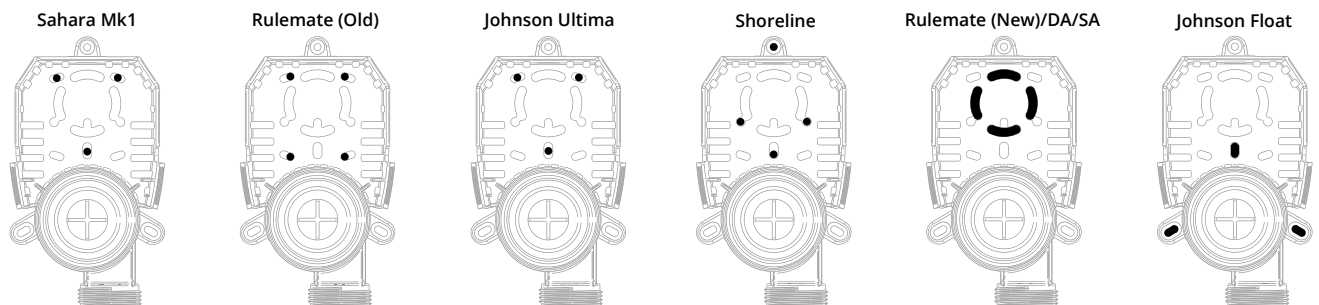

Sahara Mk1 Automatic Bilge Pumps



An automatic-switch bilge pump is a requirement for any vessels 20' and over with sleeping accommodations, but is a great convenience for any size boat. The Sahara has everything contained in one compact yet durable package – pump, wire seals, strainer, and mercury-free switch – and installs quickly and easily in tight spaces. Pumps include 29" lengths of 16-gauge caulked and tinned copper wire.

Available for 2021 & 2022

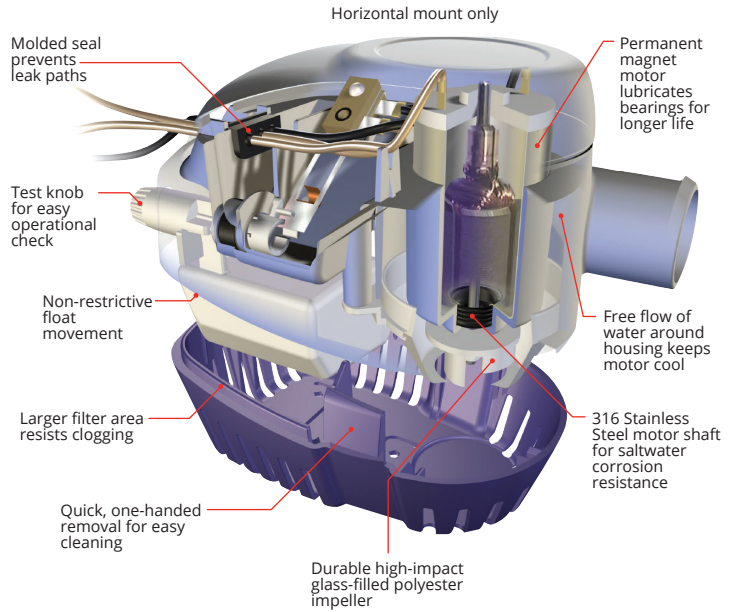
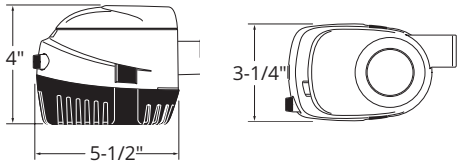

Specifications (Motor Running)

Model No.	Rated Voltage	Design Voltage	Amp Draw	GPH Output @ Design Voltage 13.6V DC				Max Head	Amp Draw	GPH Output @ Nominal Voltage 12.0V DC				Fuse Size	Hose Size
				0 ft.	3.3 ft.	6.7 ft.	9 ft.			0 ft.	3.3 ft.	6.7 ft.	9 ft.		
S500	12	13.6	1.5	500	350	200	9 ft.	1.2	450	300	190	8 ft.	3A	3/4" I.D.	
S750	12	13.6	2.8	750	625	450	16 ft.	2.5	660	480	345	12 ft.	5A	3/4" I.D.	
S750	24	27.2	1.5	750	625	450	16 ft.	1.2	660	480	345	12 ft.	2A	3/4" I.D.	
S1100	12	13.6	4	1100	973	750	11 ft.	3.4	1070	820	615	9 ft.	6A	1-1/8" I.D.	
S1100	24	27.2	1.9	1100	973	750	11 ft.	1.4	1070	820	615	9 ft.	3A	1-1/8" I.D.	

S500 Pump

S500 has plenty of pumping power for most jobs. 500 GPH † at open flow, 350 GPH † at 3.3' head. Draws only 1.5A at open flow!

Model No.	Rated Voltage	Hose Size	Wire/Connector	OEM Part #	Part #
S500	12V	3/4" I.D.	29" wire	4505-1	4505-7
S500 with Stainless Steel Strainer	12V	3/4" I.D.	29" wire	4505S1	—
Stainless Steel Strainer	—	—	—	4236	—



S750 Pump

S750 is sized for larger recreational boats. Our most powerful 3/4"-outlet automatic pump. 750 GPH † at open flow, 625 GPH † at 3.3' head. 3/4" hose outlet.

Model No.	Rated Voltage	Hose Size	Wire/Connector	OEM Part #	Part #
S750	12V	3/4" I.D.	29" wire	4507-1	4507-7
S750 with Stainless Steel strainer	12V	3/4" I.D.	29" wire	4507S1	—
S750	24V	3/4" I.D.	29" wire	4508-1	—
Stainless Steel Strainer	—	—	—	4236	—



S1100 Pump

S1100 is our most powerful and efficient automatic pump. High capacity for larger boats and yachts. 1100 GPH † at open flow, 973 GPH † at 3.3' head. 1-1/8" hose outlet.

Model No.	Rated Voltage	Hose Size	Wire/Connector	OEM Part #	Part #
S1100	12V	1-1/8" I.D.	29" wire	4511-1	4511-7
S1100 with Stainless Steel strainer	12V	1-1/8" I.D.	29" wire	4511S1	—
S1100	24V	1-1/8" I.D.	29" wire	4512-1	—
Stainless Steel Strainer	—	—	—	4236	—



† Listed GPH is measured at design voltage of 13.6V DC.

Heavy-Duty Bilge Pumps

Integrates the highest quality bearings, brushes, alloys and magnets designed to withstand extreme usage cycles. Pump also employs an exclusive shaft and motor compartment, reducing wear and significantly extending pump life. Advanced resin compositions incorporated into exterior to resist chemicals such as engine oil, aggressive detergents and hose plasticisers. Attwood's Heavy Duty Bilge has unsurpassed durability and efficiency in a compact design to ensure electrical energy is converted to the pump rather than excess heat. This pump is fully submersible.

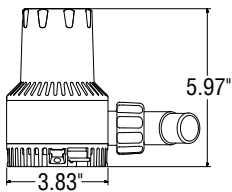
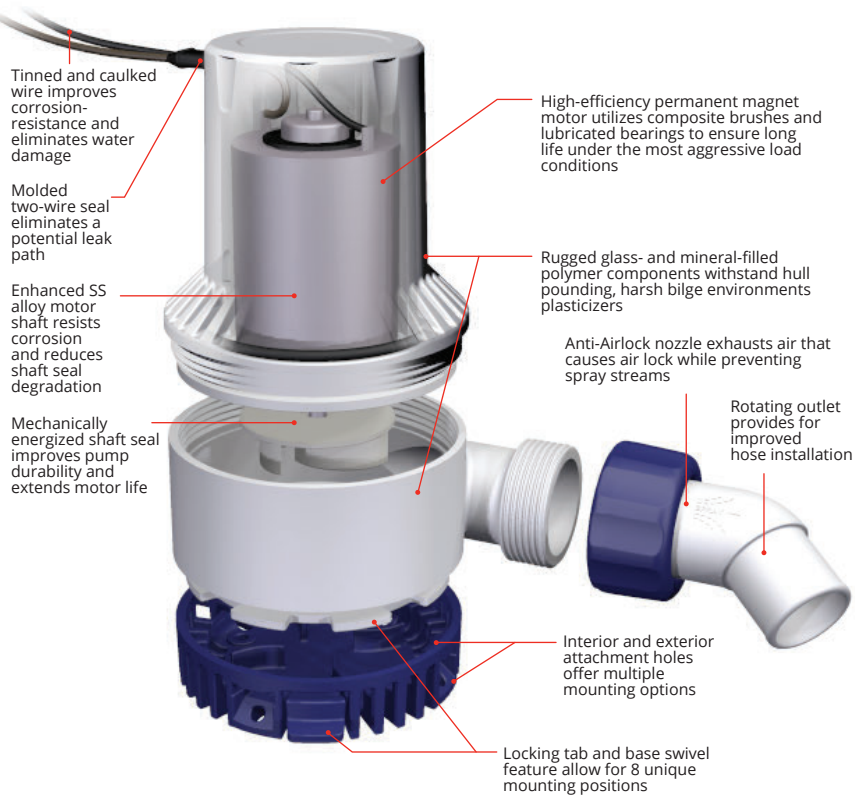

Specifications

Model No.	Rated Voltage	Amp Draw	GPH Output @ Design Voltage 13.6V DC				GPH Output @ Nominal Voltage 12.0V DC				Fuse Size	Hose Size	
			0 ft.	3.3 ft.	6.7 ft.	Max Head	0 ft.	3.3 ft.	6.7 ft.	Max Head			
HD1700	12	5.7	1700	1300	950	12 ft.	5.1	1500	1100	800	11 ft.	10A	1-1/8" I.D.
HD2000	12	6.6	2000	1600	1230	17 ft.	6	1800	1500	1200	16 ft.	12A	1-1/8" I.D.
	24	3.5	2000	1600	1230	17 ft.	2.9	1800	1500	1200	16 ft.	7A	1-1/8" I.D.

HD1700 Pump

The perfect upgrade from 1500 GPH rated pumps, especially older, over-rated designs. Delivers a true 1700 GPH at open flow while drawing less than 6A.

Model No.	Rated Voltage	Wire/ Connector	OEM Part #	Part #
HD1700	12V	36" wire	4730-1	4730-4

HD 1700 Pump with Anti-Airlock nozzle



HD2000 Pump

Attwood's highest capacity bilge pump! Ball-bearing design provides for cooler motor operation and longer life. Delivers over 2000 GPH at open flow while drawing less than 7A.

Model No.	Rated Voltage	Wire/ Connector	OEM Part #	Part #
HD2000	12V	36" wire	4760-1	4760-4
	24V	36" wire	4770-1	4770-4

HD 2000 Pump with Anti-Airlock nozzle





Manual Bilge Pumps NEW

Tsunami Mk2 is the only manual bilge pump that eliminates air-locks

- Patented X-Air™ Impeller ejects trapped air in the pump and pipework.

Tsunami Mk2 is the easiest manual bilge pump to install and service

- Backwards compatible hole pattern and motor cartridges of Tsunami Mk1 bilge and aerator pumps.
- External mounting feet and integrated outlet reduces time and effort.
- Service pump cartridge from hard-to-reach areas using only one hand.

Tsunami Mk2 is the most reliable manual bilge pump in freshwater applications

- 40% better protection against water ingress and electrolysis - vs. Mk1.

Certifications, Standards and Listings

The Tsunami Mk2 Manual Bilge Pumps meet or exceed the following U.S. and international certificates and standards:

Bilge pumps standards

- ABYC H-22
- ISO 8849
- ISO 15083

Marine electrical wiring standards

- ABYC E-11
- ISO 10133
- U.S. Coast Guard Rule, 33CFR-183.425

Ignition protection standards

- ISO 8846 Marine

Approvals

- NMMA "As approved listing"
- CE, RCM, UKCA

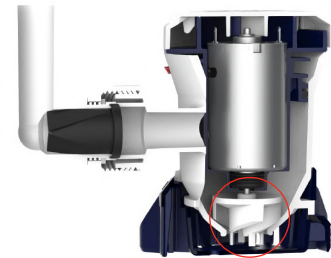
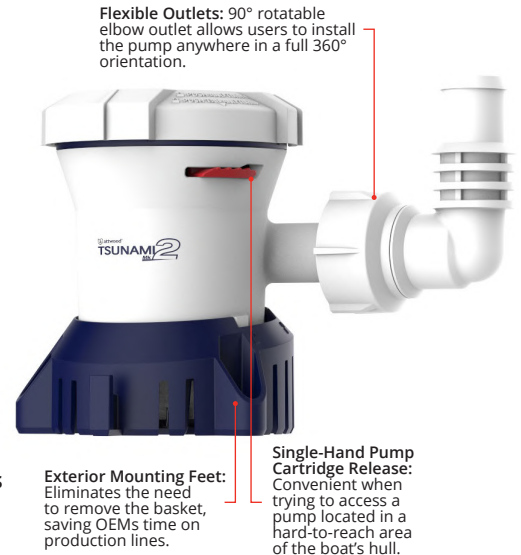

Patented X-Air™ Impeller: Prevents air locking so that the pump will not run dry and burn out.

Model No.	Rated Volts DC	Fuse Size	Outlet Type	Check Valve	Wire Length	OEM Part #	OEM Outlet Straight	OEM Outlet 90°	Part #	Service Kit
T500	12V	3A	3/4" (19mm) & 1" (25mm) Barbs	Y	29" (735mm)	—	—	—	5606-7	AK5605-7
	12V	3A	3/4" (19mm) Barb	N	29" (735mm)	5606B-1	—	—	—	—
	12V	3A	1-3/8" Threaded*	Optional	29" (735mm)	5606-1	AS5605S-1	AS5605E-1	—	AK5605-7



Model No.	Rated Volts DC	Fuse Size	Outlet Type	Check Valve	Wire Length	OEM Part #	OEM Outlet Straight	OEM Outlet 90°	Part #	Service Kit
T800	12V	5A	3/4" (19mm) & 1" (25mm) Barbs	Y	29" (735mm)	—	—	—	5608-7	AK5605-7
	12V	5A	3/4" (19mm) Barb	N	29" (735mm)	5608B-1	—	—	—	—
	12V	5A	1-3/8" Threaded*	Optional	29" (735mm)	5608-1	AS5605S-1	AS5605E-1	—	AK5605-7
T800	24V	2A	3/4" (19mm) & 1" (25mm) Barbs	Y	29" (735mm)	—	—	—	5609-7	AK5605-7
	24V	2A	3/4" (19mm) Barb	N	29" (735mm)	5609B-1	—	—	—	—
	24V	2A	1-3/8" Threaded*	Optional	29" (735mm)	5609-1	AS5605S-1	AS5605E-1	—	AK5605-7



Model No.	Rated Volts DC	Fuse Size	Outlet Type	Check Valve	Wire Length	OEM Part #	OEM Outlet Straight	OEM Outlet 90°	Part #	Service Kit
T1200	12V	6A	3/4" (19mm) & 1" (25mm) Barbs	Y	29" (735mm)	—	—	—	5612-7	AK5612-7
	12V	6A	3/4" (19mm) Barb	N	29" (735mm)	5612B-1	—	—	—	—
	12V	6A	1-3/8" Threaded*	Optional	29" (735mm)	5612-1	AS5612S-1	AS5612E-1	—	AK5612-7
T1200	24V	3A	3/4" (19mm) & 1" (25mm) Barbs	Y	29" (735mm)	—	—	—	5613-7	AK5612-7
	24V	3A	3/4" (19mm) Barb	N	29" (735mm)	5613B-1	—	—	—	—
	24V	3A	1-3/8" Threaded*	Optional	29" (735mm)	5613-1	AS5612S-1	AS5612E-1	—	AK5612-7



* Must be used with appropriate Tsunami outlet.

500 Dimensions

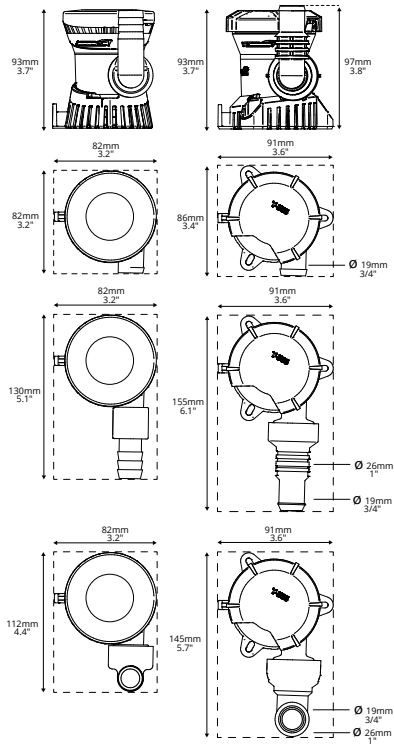

800 Dimensions

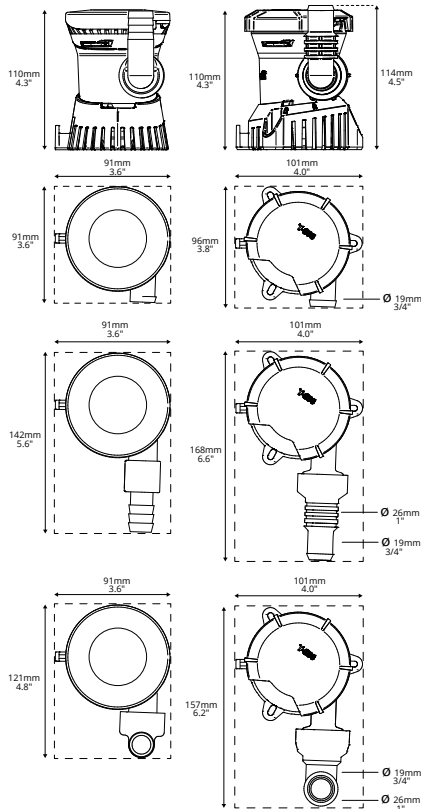

1200 Dimensions

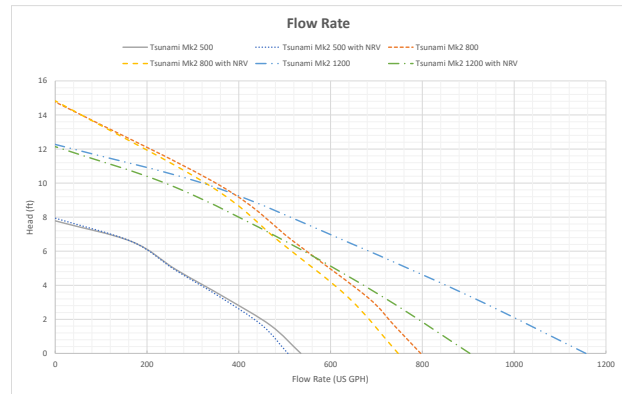
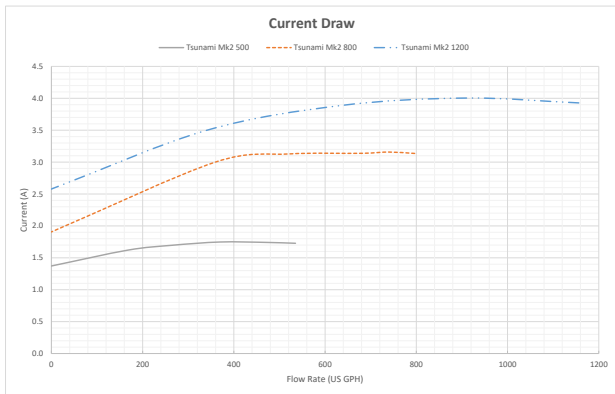
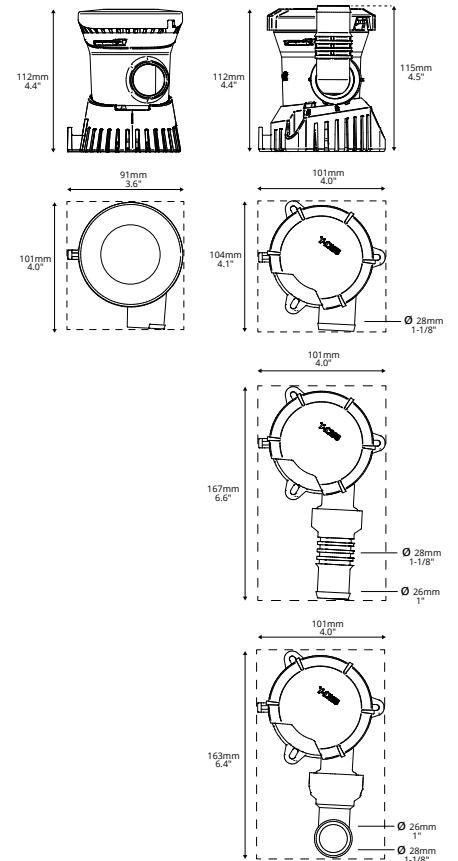

Mounting Pattern Compatibility

Tsunami Mk1 500

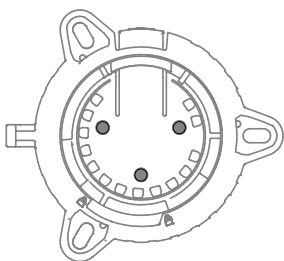

Tsunami Mk1 800 / 1200

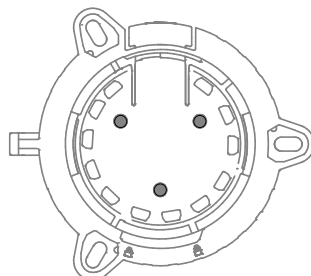

Johnson L Series

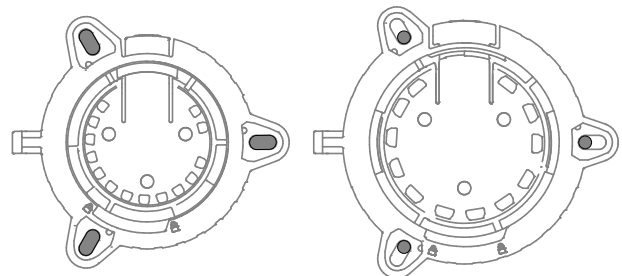

Aerator Pumps

Tsunami Mk1 Aerator Pumps

With their innovative engineering and compact design, Tsunami pumps deliver high output from a small package. We use the most advanced material available, including the best quality bearings and state-of-the-art brushes, alloys and magnets. Our patented shaft seal prevents leaks caused by misalignment and our caulked and tinned wiring eliminates wicking, prevents water damage and resists corrosion.

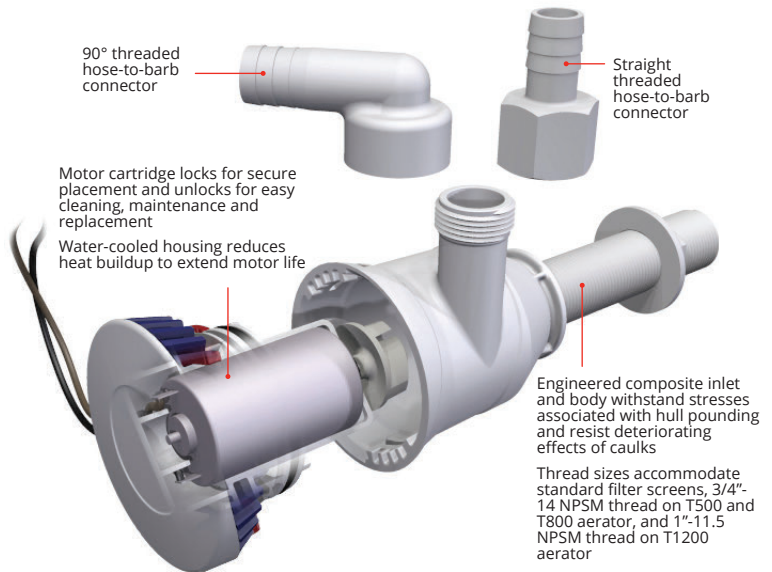

Pump Dimensions

Model	Application	A	B	C	D	E	F	G
T500	Thru-Hull	3-1/2" or 1-1/2"	3" or 1"	3-1/4"	2-7/8"	3-5/8"	3/4-14 NPSM	3/4-14 NPSM
	Seacock	1-1/2"	1"	3-1/4"	2-7/8"	3-5/8"	3/4-14 NPT	3/4-14 NPSM
T800	Thru-Hull	3-1/2" or 1-1/2"	3" or 1"	3-7/8"	3-1/4"	4"	3/4-14 NPSM	3/4-14 NPSM
	Seacock	1-1/2"	1"	3-7/8"	3-1/4"	4"	3/4-14 NPT	3/4-14 NPSM
T1200	Thru-Hull	3-1/2" or 1-1/2"	3" or 1"	4"	3-1/4"	4-7/8"	1-3/8-12 UNF	1-3/8-12 UNF
	Seacock	1-1/2"	1"	4"	3-1/4"	4-7/8"	1-11-1/2 NPT	1-3/8-12 UNF

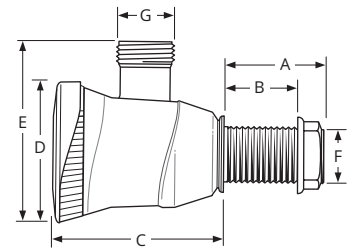

Specifications

Model No.	Rated Voltage	GPH Output @ Design Voltage 13.6V DC						GPH Output @ Nominal Voltage 12.0V DC					
		Amp Draw	0 ft.	3.3 ft.	6.7 ft.	Max Head	Amp Draw	0 ft.	3.3 ft.	6.7 ft.	Max Head	Fuse Size	Hose Size
T500	12	1.8	500	440	260	9 ft.	1.4	450	330	160	8 ft.	3A	3/4" O.D.
T800	12	3	800	670	525	9 ft.	2.5	750	555	370	8 ft.	4A	3/4" O.D.
T1200	12	3.5	1200	840	570	9 ft.	3	1140	790	450	8 ft.	5A	1-1/8" O.D.

Tsunami Aerator Pumps & Accessories

No mounting brackets necessary.

Model No.	Inlet Length & Diameter	Outlet Style & I.D. Diameter	Rated Voltage	Wire/ Connector	OEM Part #	Part #
Tsunami Aerator Pumps						
T500	3-1/2" L x 3/4"	Threaded - 3/4"	12V	29" wire	4640-1	4640-7
	1-1/2" L x 3/4"	Threaded - 3/4"	12V	29" wire	4641-1	—
	7/8" L x 3/4"	Threaded - 3/4"	12V	29" wire used with 3/4" seacock	4643-1	4643-7
T800	3-1/2" L x 3/4"	Threaded - 3/4"	12V	29" wire	4650-1	4650-7
	1-1/2" L x 3/4"	Threaded - 3/4"	12V	29" wire	4651-1	—
T1200	3-1/2" L x 1-1/8"	Threaded - 1-1/8"	12V	29" wire	4660-1	4660-7
	1-1/2" L x 1-1/8"	Threaded - 1-1/8"	12V	29" wire	4661-1	—
	7/8" L x 1"	Threaded - 1-1/8"	12V	29" wire used with 1" seacock	4663-1	—
Tsunami Replacement Motor Cartridges						
T500			12V	29" wire	—	4620-6
T800			12V	29" wire	—	4622-6
T1200			12V	29" wire	—	4624-6



Tsunami Dual Outlet Aerator Pumps

The advantage of the dual outlet is that you can feed multiple applications through a single thru-hull fitting. The Tsunami second outlet is integrated into the pressure chamber, so it looks – and pumps – like part of the aerator. Both of the pump's outlets are engineered for the precise position and angle that will deliver optimum performance.



90° threaded hose-to-barb connector

Straight threaded hose-to-barb connector

Motor cartridge locks for secure placement and unlocks for easy cleaning, maintenance and replacement

Water-cooled housing reduces heat buildup to extend motor life

Thread sizes accommodate standard filter screens, 3/4"-14 NPSM thread on T500 and T800 aerator, and 1"-11.5 NPSM thread on T1200 aerator

Engineered composite inlet and body withstand stresses associated with hull pounding and resist deteriorating effects of caulks

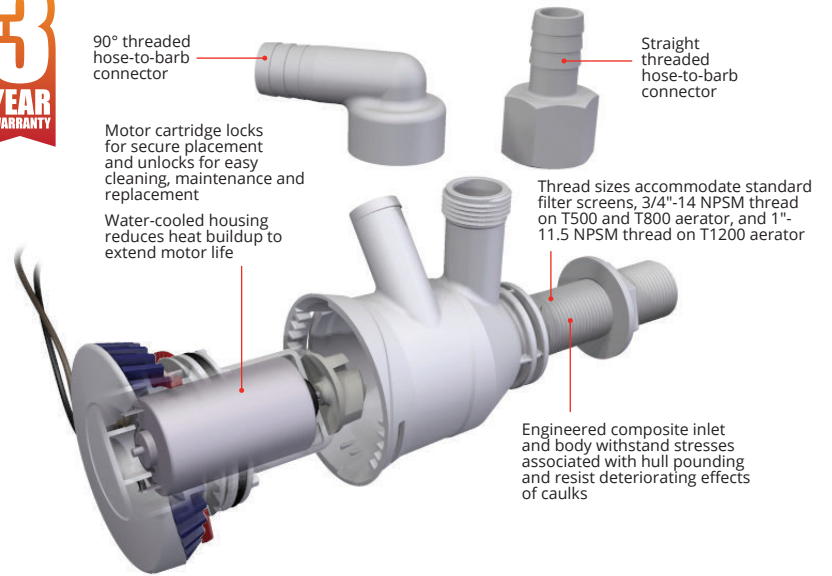
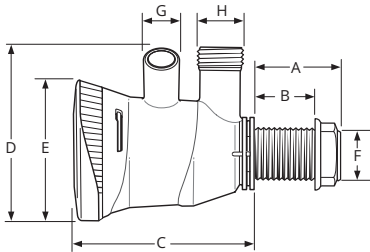

Applications:

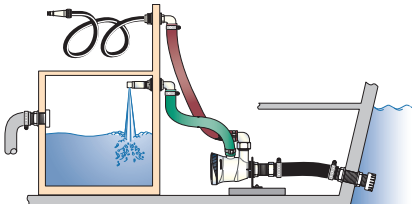

Rinse Hose plus Livewell

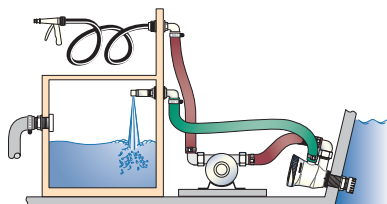

High Pressure Washdown plus Livewell

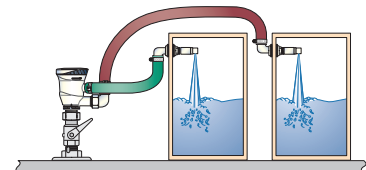

Supply Two Livewells

Pump Dimensions

Part No.	Inlet Length	Inlet Dia.	A	B	C	D	E	F	G	H
4672	3-1/2"	3/4"	3-1/4"	3"	4-1/8"	4-1/4"	4"	3/4-14 NPSM	3/4" Barbed	.554" I.D. 3/4-14 NPSM .620" I.D.
4670	3/4"	3/4"	1-1/4"	7/16"	4-1/8"	4-1/4"	4"	3/4-14 NPT	3/4" Barbed	.554" I.D. 3/4-14 NPSM .620" I.D.

Specifications

Outlet	Amp Draw	GPH Output @ Design Voltage 13.6V DC					GPH Output @ Nominal Voltage 12.0V DC					Fuse Size	
		0 ft.	3.3 ft.	6.7 ft.	Max Head	0 ft.	Amp Draw	0 ft.	3.3 ft.	6.7 ft.	Max Head		
Upper	3.0	750	600	460	13 ft.	880	2.5	670	500	390	11 ft.	770	4A
Lower	3.0	750	620	480	13 ft.	880	2.5	690	550	420	11 ft.	770	4A



Tsunami Dual Outlet Aerator Pumps & Accessories

No mounting brackets necessary.

Model No.	Inlet Length & Diameter	Rated Voltage	Wire/Connector	OEM Part #	Part #
Tsunami Dual Outlet Aerator Pumps					
T800	3-1/2" L x 3/4"	12V	29" wire	4672-1	4672-7
	7/8" L x 3/4"	12V	29" wire, use with 3/4" seacock	4670-1	4670-7
Tsunami Replacement Motor Cartridge					
T800		12V	29" wire	—	4622-6

Bilge & Float Switches

S3 Series Automatic Bilge Switches

Incorporates a proprietary Electronic Sensing technology to detect bilge water levels and trigger pump activation and has been engineered to operate in any bilge water mixture consistently without failure. Your pump won't be exposed to continuous cycling as the S3 switch can easily distinguish splashing bilge water, chemicals, sludge build up or foam, and comes equipped with fully sealed electronics that are completely protected from water or chemical damage. For added convenience, the bilge switch can be mounted on the floor of the bilge, directly to a stringer wall, or alongside the basket of the pump without added components or brackets. The S3 Series switch is also directly compatible with all competitive products and free of moving parts that can jam up, break or wear out over time. Marine ignition protected and RoHS compliant.

5
YEAR
WARRANTY



Description	Max. Pump Amp Draw	Rated Voltage	Wire	OEM Part #	Part #
Switch, White	15A	12V	36" wire	4801-1	4801-7

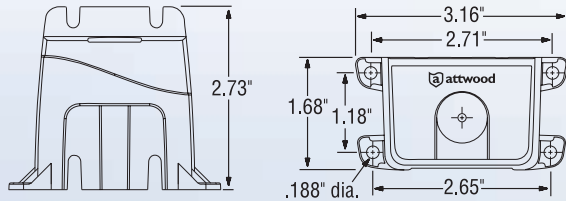

Automatic Float Switches

Converts bilge pumps to fully automatic operation. Maximum amp draw is 12A (at 12V DC) or 6A (at 24V DC). Features a compact, low-profile design that mounts on any surface from horizontal up to a 24° angle. Incorporates a reliable and affordable mechanical switch that actuates pump motor at 2" water level. Wire leads do not flex or hinge with the float as on some competitive models. Integral cover dampens bilge sloshing to reduce pump cycling, and prevents debris interference. Sealed switch mechanism resists moisture, fume-ignition, and electrical shock. Contains no mercury, which is listed as a health hazard and "Persistent Toxic Substance" in over 26 states. Marine ignition protected and RoHS compliant.

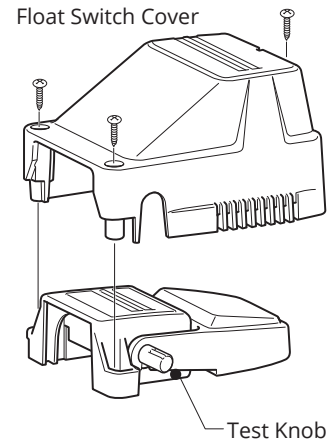

Float Switch with Cover

Description	Rated Voltage	Wire/Connector	OEM Part #	Part #
Float switch with cover	12V and 24V CE rated	36" wire	4201-1	4201-7

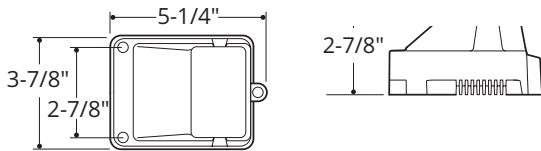

4201

Float Switch

Description	Rated Voltage	Wire/Connector	OEM Part #	Part #
Float switch	12V and 24V CE rated	36" wire	4202-1	4202-7

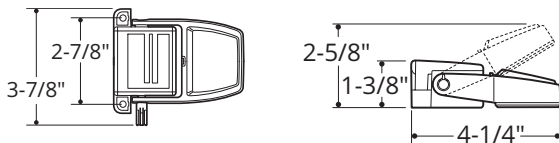

4202

Shower & Washdown Systems

Shower Sump Pump Systems

Attwood's shower sump systems deliver the performance you've been asking for. Choose from standard box or large box sizes. Offering fast water flow into and out of sump. The lid snaps in to allow quick installation (and removal for cleaning) and includes a gasket to seal the sump box against overflow. The sump box even includes an air vent to prevent air locks. Meets or exceeds all applicable standards of the ABYC and USCG.

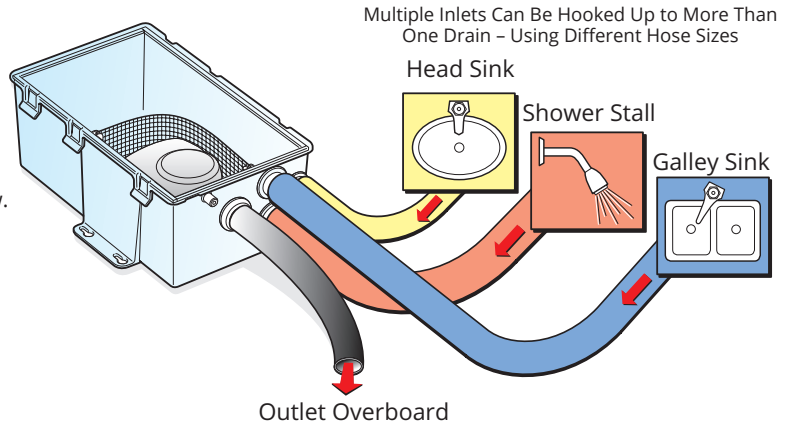

Specifications

Model	Rated Voltage	Fuse Size	Outlet Hose Size
500 GPH	12V	3A	3/4" I.D.
750 GPH	12V	5A	3/4" I.D.
750 GPH	24V	2A	3/4" I.D.

Output Ratings

Model	Amp Draw	GPH Output @ Design Voltage 13.6V DC			GPH Output @ Nominal Voltage 12.0V DC		
		0 ft.	3.3 ft.	6.7 ft.	0 ft.	3.3 ft.	6.7 ft.
500 GPH	1.4	420	360	215	385	290	130
750 GPH	2.5	650	500	385	570	420	290

Performance for 24V version is the same (Uses 2 Amp Fuses)

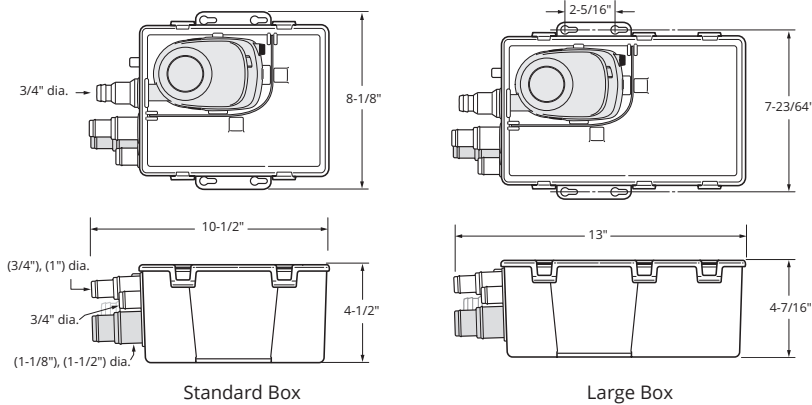

Model No.	Rated Voltage	Wire/ Connector	Box Size	OEM Part #	Part #
500 GPH	12V	22" wire	Standard	4141-1	4141-4
750 GPH	12V	22" wire	Standard	4142-1	—
750 GPH	12V	22" wire	Large	4143-1	4143-4
750 GPH	24V	22" wire	Large	4144-1	—
750 GPH	24V	22" wire	Standard	4145-1	—
Lid	—	—	Standard	001001668	—
Lid	—	—	Large	001001667	—

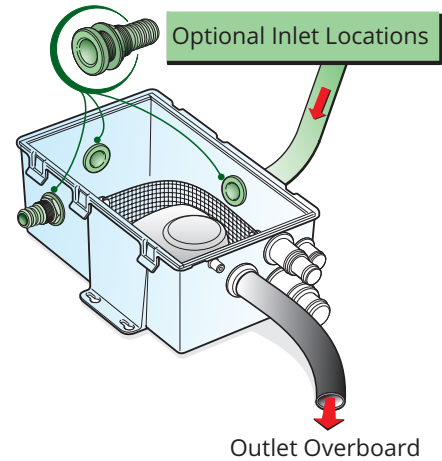

4141



4143

Aft-Deck Shower

Install flush in the transom or under the gunwale. Includes hinged cover and replaceable sprayer head. Fixtures are corrosion-resistant. Housing and cover are made of high-impact, UV resistant, engineering-grade plastic and are pre-drilled for six #8 fasteners. Comes with 6' hose, shut-off, and hot/cold mixing controls. Connects to freshwater system for showering.

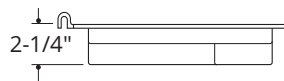
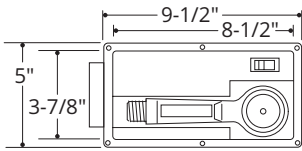

Description	Function	Hose Length	OEM Part #	Part #
Aft-Deck	Hot/cold	6'	4131-1	4131-4



4131

Cold Water Shower

Install flush in the transom or under the gunwale. Includes hinged cover and replaceable sprayer head. Fixtures are corrosion-resistant. Housing and cover are made of high-impact, UV resistant, engineering-grade plastic and are pre-drilled for six #8 fasteners. Hand-held shower sprayer with 6' hose and shut-off. Connects to freshwater system or self-priming wash-down pump for showering after swimming. Built-in on/off switch for pump.

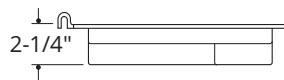
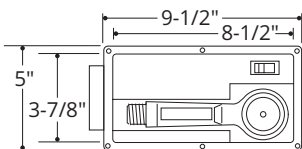

Description	Function	Hose Length	OEM Part #	Part #
Cold Water	On/off switch	6'	4133-1	—



4133

Battery & Hand Operated Pumps

WaterBuster® Portable Pump

This submersible pump is a great way to remove unwanted water from boats, pool covers, aquariums and sump pits. Convenient and safe because it needs no electrical cord — runs up to five hours on three alkaline "D" batteries. Excellent for use as a portable pump-out device for paddle boats, inflatables, duck boats, dingies or kayaks, any craft that lacks a hard-wire, permanent electrical system.

- 6-3/8" high x 5-1/4" diameter
- Pumps up to 200 gallons per hour
- Includes 42" hose with garden hose adapter for adding longer hose
- Lifts water to height of 40"

Note: Not to be used as a permanent bilge pump

Description	GPH Open Flow	GPH 2 ft. Head †	OEM Part #	Part #
Portable Pump	200	125	—	4140-4

† 4 ft. maximum head



4140

Hand-Operated Bilge Pumps

Safely remove unwanted water, or other liquids, from kayaks and other small boats.

Description	OEM Part #	Part #
Kayak Hand Bilge Pump, 18"	—	11595-2
Hand Bilge Pump, 24", 32" Hose	—	11596-2



11595

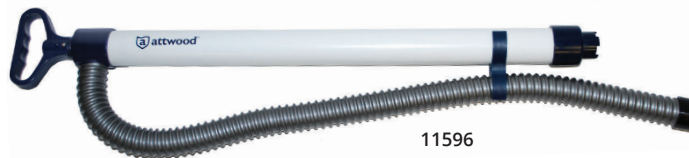

11596

Pump Kits & Accessories

Tsunami Recirq Aerator Kit

The Tsunami Recirq Kit recirculates livewell water to keep it cooler and rich in oxygen. This self-contained system feeds a separate aerator spray head and works even while you are underway and cannot use a thru-hull connection. Add this kit to any tank that already has a freshwater fill system. Or use as a backup pump for a fail-safe system.

Recirq Kit includes:

- (1) 500 GPH Tsunami aerator pump with short inlet, threaded outlet
- (1) 4125-1 aerator spray head
- (1) 4232-1 Stainless Steel strainer
- (2) Plastic hose clamps
- (1) 3/4" diameter x 23" long poly hose
- (1) Straight thread-to-barb connector



4253

Description	OEM Part #	Part #
T-500 Recirq Livewell Aerator Kit	—	4253-7

Bilge Pump Installation Kits

Complete kit to install manual bilge pump with 3/4" I.D. hose outlet.

- (1) 2-way on/off switch with bezel plate
- (1) 3/4" I.D. x 5' corrugated hose
- (1) Thru-hull fitting for 3/4" I.D. hose
- (2) Snap-It hose clamps
- (1) 2-conductor 16-gauge wire, 20' long
- (1) In-line fuse holder with 2A fuse

Caution: Bilge pump switches are not external ignition protected.



4116

Description	Hose Size	OEM Part #	Part #
Complete kit (without pump)	3/4" I.D.	—	4116-5
Complete kit with Tsunami T-500 bilge pump	3/4" I.D.	—	4614-7
6' hose with (2) clamps	3/4" I.D.	—	4199-7
6' hose only	1-1/8" I.D.	—	11551-5

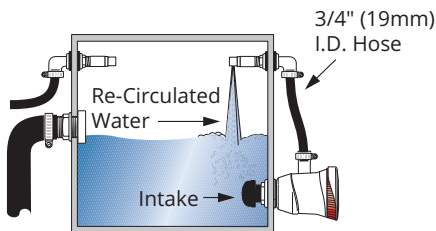

4614

Aerator Remote Mounting Brackets

For mounting the aerator pump to a base, away from the transom.

Description	OEM Part #	Part #
1-1/8" Aerator remote mounting bracket	4121-1	4121-3
3/4" Aerator remote mounting bracket	4122-1	4122-3

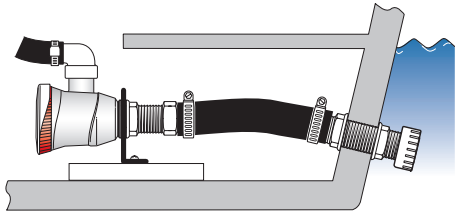

Aerator Spray Heads

For use on livewells that have built-in overflows or recirculating systems.

Adjustable Spray Heads

Mounts on sides of tank. 90° fitting for installation in tight spaces. Rotating head with O-ring adjusts and maintains flow setting. Removable head has an "interference-fit thread design" that will not allow it to vibrate or blow out. Polypropylene construction. Can be installed on tanks with up to 5/8" wall thickness.

Non-Adjustable Spray Heads

Multi-port spray maximizes oxygen level in the livewell. Constructed of ABS plastic. Double Valve Spray Head - Allows aerating options – one end can be used for freshwater fill, the other end with a recirculating pump. Single Valve Spray Head - For output from an aerator pump into the livewell.

Description	Hose I.D.	OEM Part #	Part #
Adjustable Spray Heads			
Aerator spray head	3/4"	4125-1	4125-7
Aerator spray head w/male connector for Flow-Rite™ Qwik-Lok™ Coupler 3	3/4"	4123-1	—
Non-Adjustable Spray Heads			
Aerator spray head, single valve	3/4"	4118A1	4118A5



Check Tees

These check tees replace additional connections for RV and marine hookups, providing a combination check valve and tee that allows water to flow in from the dockside connection without filling the tank. Constructed of ABS plastic.

Combination Barbed Fitting

Inlet and outlet both have combination fittings: Comes with 3/8" barbs that can be removed to accommodate 1/4" NPT fitting. 1/2" NPT fitting for dockside water connection.

Combination Barbed Inlet/Threaded Outlet

Inlet has combination fitting: Comes with 3/8" barbs that can be removed to accommodate 1/4" NPT fitting. Outlet is 1/2" NPSM. 1/2" NPT fitting for dockside water connection.

Description	OEM Part #	Part #
Combination barbed fitting	6115-1	—



Plumbing System Fittings

Snap-It Hose Clamps

Use on bilge pumps and shower sump systems. Corrosion-resistant plastic.

Note: Clamps are intended for water and waste system hoses only.

Description	Hose O.D.	Hose I.D.	OEM Part #	Part #
Snap-It Hose Clamp	7/8" to 1"	3/4"	9185J1	—

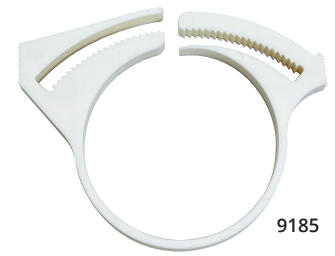

Tees

Three-way 90° fitting. Acetal construction.

Description	Hose I.D.	OEM Part #	Part #
Tee	3/4"	3892-1	—
Tee	1-1/8" to 1-1/4"	3893-1	—



Straight Connectors

Threaded end fits 3888 drain fitting, A-Series aerator pump outlets and Tsunami threaded outlets. Acetal construction.

3899: Barbed end accommodates 3/4" I.D. hose.

3909: Male end accommodates Flow-Rite™ Qwik-Lok™ Coupler.

Description	Use With	OEM Part #	Part #
Thread-to-Barb 3/4"-14 NPSM and 3/4" I.D. hose fitting	500-800 GPH pumps	3899-1	3899-3
Thread-to-Flow-Rite™ Qwik-Lok™ Connector fitting	500-800 GPH pumps	3909-1	—
Thread-to-Barb Straight 1-3/8" - 12 UNF thread & 1-1/8" hose fitting	1200 GPH pumps	3902-1	3902-3

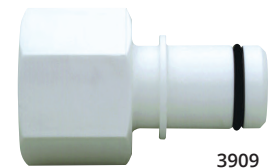

90° Connectors

3890: Threaded female end fits 3888 drain fitting or A-Series aerator pump outlets and Tsunami threaded outlets. Barbed end accommodates 3/4" I.D. hose. Acetal construction.

3900: Threaded end fits A-Series aerator pump outlets and Tsunami threaded outlets. Male end accommodates Flow-Rite™ Qwik-Lok™ Coupler.

3891: Threaded end fits 3889 drain fitting. High-impact plastic. Barbed end accommodates 1-1/8" or 1-1/4" I.D. hose. Acetal construction.

Description	Use With	OEM Part #	Part #
For 3/4"-14 threads and 3/4" I.D. hose	500-800 GPH pumps	3890-1	3890-3
Thread-to-Flow-Rite™ Qwik-Lok™ Connector	500-800 GPH pumps	3900-1	—
For 1-3/8"-12 threads and 1-1/8" or 1-1/4" I.D. hose	1200 GPH pumps	3891-1	—



Stainless Steel Thru-Hulls & Scupper Valve Fittings

Polish your image with these beautiful, durable stainless steel fittings. Each Thru-Hull and Scupper Valve is available with a new silicone gasket and are backed by Attwood's trusted Lifetime Warranty! Why specify plastic parts when these fittings will last the life of the boat?



Rugged Stainless Construction

- Cast from certified Enhanced 316 Stainless Steel alloy for strength and lifetime corrosion-resistance
- We polish all visible areas to a mirror finish, then passivate each part for additional protection
- Thick steel sidewalls withstand continual stress and hose flexing

Faster, Simpler Installation

- A channel under the flange holds a bead of sealant, making it easier to apply a trouble-free seal
- All models have wrench flats or an end notch to hold as a gripping surface. One installer can tighten all connections from inside the hull
- Barbed tail ends provide plenty of room to hold multiple clamps

Stainless Steel Straight Thru-Hulls, Barbed

- Standard Thread model has full-length thread for thick hulls and easy tightening
 - Short Thread is a more compact size. Allows installation near corners and in confined areas.
- Caution: Stainless Steel Scupper Valves are designed for installation above the water line only.

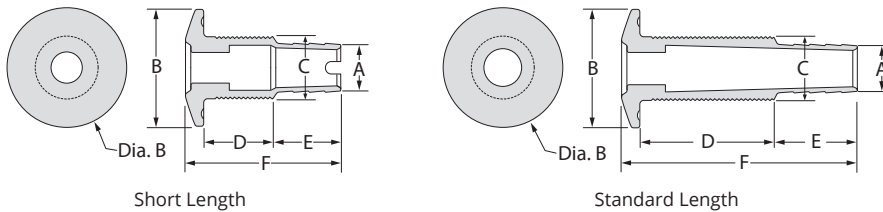

66540G

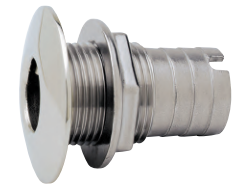

66542



66546G



66548

A Hose Size	B Flange Dia.	C Thread O.D.	D Thread Length	E Barb Length	F Total Length	Install. Hole Saw Size	Thread NPSM	Max Hull Thick.	OEM Part # without Gasket	Part #
Short Length										
5/8" I.D.	1-7/8"	1"	1"	1"	2-1/4"	1-1/8"	3/4"	5/8"	66540-1	66540-3
3/4" I.D.	1-7/8"	1"	1"	1"	2-1/2"	1-1/8"	3/4"	5/8"	66541-1	66541-3
1" I.D.	2-1/4"	1-3/8"	1-1/8"	1"	2-1/2"	1-1/2"	1"	5/8"	66542-1	66542-3
1-1/8" I.D.	2-1/4"	1-3/8"	1-1/4"	1"	2-1/2"	1-1/2"	1"	5/8"	66543-1	66543-3
1-1/4" I.D.	2-1/4"	1-5/8"	1-1/4"	1"	2-5/8"	1-3/4"	1-1/4"	5/8"	66544-1	66544-3
1-1/2" I.D.	3"	1-7/8"	1-1/4"	1-1/2"	3-1/8"	2"	1-1/2"	5/8"	66545-1	66545-3
Standard Length										
5/8" I.D.	1-7/8"	1"	2"	1-1/4"	3-3/4"	1-1/8"	3/4"	1-1/16"	66546-1	66546-3
3/4" I.D.	1-7/8"	1"	2"	1-1/4"	3-3/4"	1-1/8"	3/4"	1-5/8"	66547-1	66547-3
1" I.D.	2-1/4"	1-3/8"	2-1/4"	1-1/4"	3-7/8"	1-1/2"	1"	1-3/4"	66548-1	66548-3
1-1/8" I.D.	2-1/4"	1-3/8"	2-3/8"	1-1/4"	3-7/8"	1-1/4"	1"	1-3/4"	66549-1	66549-3
1-1/4" I.D.	2-1/4"	1-5/8"	2-1/2"	1-1/4"	4-1/4"	1-3/4"	1-1/4"	1-7/8"	66550-1	66550-3
1-1/2" I.D.	3"	1-7/8"	2-1/2"	1-1/4"	4-1/8"	2"	1-1/2"	1-7/8"	66551-1	66551-3
2" I.D.	3"	2-3/8"	2-1/2"	1-3/4"	4-5/8"	2-1/2"	1-1/2"	2"	66552-1	—

Stainless Steel Straight Thru-Hulls, Threaded

- Unique multi-thread design with NPSM and NPT threads
- Offer generous thread length
- Allows for direct connection to seacocks or pipes

Caution: Stainless Steel Thru-Hull Connectors are designed for installation above the water line only.

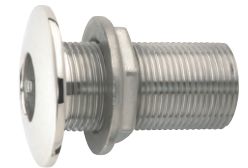
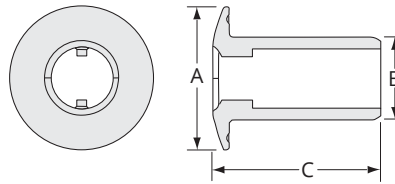

66559



66558G

A Flange Dia.	B Thread O.D.	C Total Length	Installation Hole Saw Size	Threads NPSM	Max Hull Thickness	OEM Part # without Gasket	Part #
1-7/8"	2-1/8"	2-1/2"	1-1/8"	3/4"	1-5/8"	66559-1	—
2-1/4"	2-1/4"	2-5/8"	1-3/8"	1"	1-3/4"	66561-1	—
3"	2-3/8"	2-3/4"	2"	1-1/2"	1-7/8"	66563-1	—

Stainless Steel 90° Thru-Hulls, Barbed

Allows installation in especially tight spaces.

Caution: Stainless Steel Thru-Hull Connectors are designed for installation above the water line only.

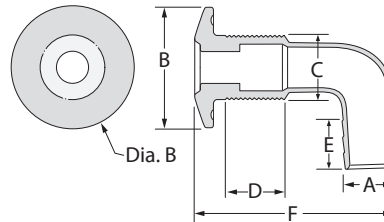

66577

A Hose Size	B Flange Dia.	C Thread O.D.	D Thread Length	E Barb Length	F Total Length	Install. Hole Saw Size	Thread NPSM	Max Hull Thick.	OEM Part # without Gasket	Part #
3/4" I.D.	1-7/8"	1"	1-1/2"	3/4"	3-3/8"	1-1/4"	3/4"	1-1/16"	66577-1	—
1-1/8" I.D.	2-1/4"	1-3/8"	1-7/8"	3/4"	4-3/8"	1-5/8"	1"	1-1/4"	66579-1	—

Stainless Steel Scupper Valves

- The Scupper Flap is tough neoprene rubber with a molded V that fits into the grooved body to reduce backwash
- Fasteners are concealed and corrosion-proof
- Enhanced 316 Stainless Steel Alloy

Caution: Stainless Steel Scupper Valves are designed for installation above the water line only.

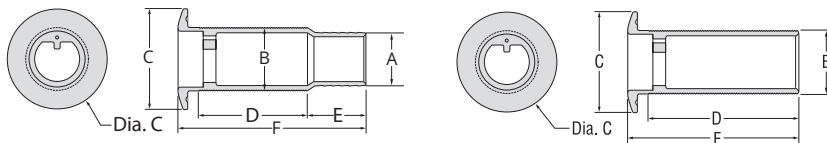

66565



66557G

A Hose Size	B Thread Dia.	C Flange O.D.	D Thread Length	E Barb Length	F Total Length	Install. Hole Saw Size	Thread NPSM	Max Hull Thick.	OEM Part # without Gasket	Part #	
Threaded											
—	1-7/8"	3"	3-1/2"	—	3-7/8"	2"	1-1/2"	3"	66565-1	—	
—	2-23/64"	3-5/8"	2-1/2"	—	2-7/8"	2-1/2"	2"	2"	66567-1	—	
Barbed											
1-1/2"	1-7/8"	3"	3-1/2"	1-1/2"	5-1/2"	2"	1-1/2"	3"	66553-1	66553-3	
2"	2-23/64"	3-5/8"	2-1/2"	1-5/16"	4-1/2"	2-1/2"	2"	2"	66555-1	—	
1-1/2"	3"	1-7/8"	2-1/4"	1-1/2"	4-1/2"	2"	1-1/2"	1-3/4"	66557-1	—	
Valve Accessories									BULK		
Replacement Flappers for 1-1/2"									66553Kit		—
Replacement Flappers for 2"									66555Kit		—

Stainless Steel Narrow Flange Thru-Hulls

- Consistent exterior appearance throughout a range of barb sizes
- Modern styling
- Enhanced 316 Stainless Steel Alloy

Caution: Stainless Steel Thru-Hull Connectors are designed for installation above the water line only.

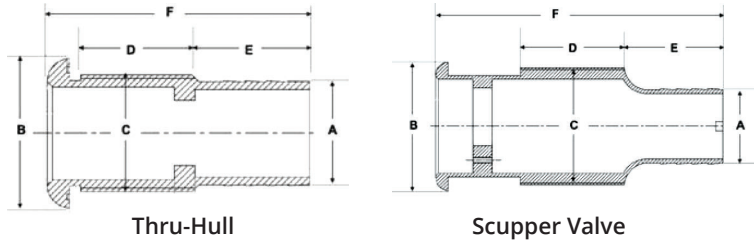

A Hose Size	B Flange Dia.	C Thread O.D.	D Thread Length	E Barb Length	F Total Length	Install. Hole Saw Size	Thread NPSM	Max Hull Thick.	OEM Part # without Gasket	Part #
Thru-Hulls, Standard Length										
5/8" I.D.	1-7/10"	1-3/10"	1-2/5"	1-1/8"	3"	1-5/16"	1"	7/8"	67555-1	—
3/4" I.D.	1-7/10"	1-3/10"	1-3/10"	1-1/4"	3"	1-5/16"	1"	3/4"	67554-1	—
1" I.D.	1-7/10"	1-3/10"	1-2/5"	1-1/8"	3"	1-5/16"	1"	7/8"	67556-1	—
1-1/8" I.D.	1-7/10"	1-3/10"	1-1/4"	1-1/8"	2-7/8"	1-5/16"	1"	3/4"	67557-1	—
1-1/2" I.D.	2-2/5"	1-7/8"	1-1/2"	1-3/5"	3-2/5"	2"	1-1/2"	1"	67551-1	—
2" I.D.	3.13"	2-3/8"	2.93"	2.04"	6.09"	2-7/16"	2"	2.70"	67552-1	—
Thru-Hulls, Long Length										
3/4" I.D.	1-7/10"	1-3/10"	1-1/2"	1-1/8"	4-1/4"	1-5/16"	1"	—	67558-1	—
1-1/8" I.D.	1-7/10"	1-3/10"	1-1/2"	1-1/8"	4-1/4"	1-5/16"	1"	—	67561-1	—
1-1/2" I.D.	2-2/5"	1-7/8"	1-1/2"	1-7/16"	4-15/16"	2"	1-1/2"	—	67562-1	—
Scupper Valve										
1-1/2" I.D.	2-3/5"	1-7/8"	2"	2"	5-3/4"	2-1/8"	1-1/2"	2-3/4"	67553-1	—



67555



67556



67551



67553

Stainless Steel Exhaust Thru-Hulls

- Specifically designed for generator and engine exhaust applications
- Features unique, modern styling that is both elegant and functional
- Stainless steel scupper valve and an integrated stainless drip ring
- Enhanced 316 Stainless Steel Alloy

Caution: Stainless Thru-Hull Connectors are designed for installation above the water line only.

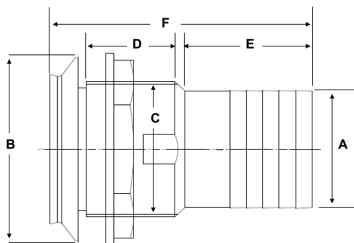

A Hose Size	B Flange Dia.	C Thread O.D.	D Thread Length	E Barb Length	F Total Length	Install. Hole Saw Size	Thread NPSM	Max Hull Thick.	OEM Part # without Gasket	Part #
1-1/2" I.D.	3.18"	2.26"	1.6"	1.97"	4.58"	2.375"	2" - 11-3/4	1.125"	67581-1	—
2" I.D.	3.18"	2.26"	1.6"	2.23"	4.58"	2.375"	2" - 11-3/4	1.125"	67580-1	—
2-1/2" I.D.	4.60"	3.375"	1.8"	2.75"	5.8"	3.625"	3" - 8	1.5"	67583-1	—
3" I.D.	4.60"	3.375"	1.8"	3"	5.8"	3.625"	3" - 8	1.5"	67582-1	—



67581



67582

Stainless Steel Capped Composite Thru-Hulls

Designed for the value conscious customer, these fittings provide the look of a Stainless Steel thru-hull at a fraction of the cost

Corrosion Resistance

Manufactured with high quality stainless steel caps and engineered composite bodies, these thru-hulls are designed to resist degradation as a result of chemical and saltwater exposure.

Consistent Look

To create a uniform look, Attwood has designed its 5/8" thru 1-1/2" barbed thru-hulls with a common exterior surface.

Improved Installation

Always keeping the builder in mind, each fitting incorporates several different types of assembly features that allow for "single operator" installation.

Caution: Stainless Steel Thru-Hull Connectors are designed for installation above the water line only.

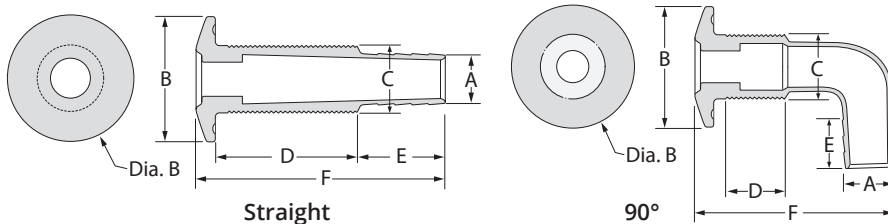

68555



68557



68576

A Hose Size	B Flange Dia.	C Thread O.D.	D Thread Length	E Barb Length	F Total Length	Installation Hole Saw Size	Max Hull Thickness	OEM Part #	Part #
Thru-Hulls, Straight									
5/8" I.D.	1-7/8"	1.27"	1.54"	1"	3.39"	1-3/8"	1.30"	68555-1	—
3/4" I.D.	1-7/8"	1.27"	1.54"	1"	3.36"	1-5/16"	1.30"	68554-1	—
1" I.D.	1-7/8"	1.27"	1.54"	1"	3.39"	1-5/16"	1.30"	68556-1	—
1-1/8" I.D.	1-7/8"	1.27"	1.54"	1.3"	3.36"	1-5/16"	1.30"	68557-1	—
1-1/2" I.D.	2-3/8"	1.5"	1.54"	1.6"	3"	1-1/2"	1.40"	68551-1	—
Thru-Hulls, 90°									
5/8" I.D.	1-7/8"	1.27"	1.54"	0.875"	3.48"	1-5/16"	1.30"	68576-1	—
3/4" I.D.	1-7/8"	1.27"	1.54"	1"	3.48"	1-5/16"	1.30"	68577-1	—
1" I.D.	1-7/8"	1.27"	1.54"	1.125"	3.75"	1-5/16"	1.30"	68578-1	—
1-1/8" I.D.	1-7/8"	1.27"	1.54"	1.5"	3.75"	1-5/16"	1.30"	68579-1	—
1-1/2" I.D.	2-3/8"	1.5"	1.54"	1.5"	4.45"	1-1/2"	1.30"	68581-1	—

Plastic Thru-Hulls & Scupper Valve Fittings

Thru-Hulls

Made of thermoplastic resins.

Caution: Plastic Thru-Hull Connectors are designed for installation above the water line only.

Fits Hose Size	Stem Length	Max Hull Thickness	Flange Diameter	Installation Hole Saw Size	Construction	Color	OEM Part #	Part #
5/8" I.D.	3-1/4"	1-1/4"	1-3/4"	1-1/8"	Polypropylene	White	3872-1	3872-3
Accommodates 7534A (5/8") bailer plug						Black	3872A1	—
3/4" I.D.	3-1/4"	1-1/4"	1-3/4"	1-1/8"	Polypropylene	White	3873-1	3873-3
Accommodates 7534A (5/8") bailer plug						Black	3873A1	—
3/4" I.D.	4"	2"	2"	1-1/16" to 1-1/8"	Acetal	White	3896-1	3896-3
1-1/8" to 1-1/4" I.D.	3-1/4"	1-1/4"	2-1/4"	1-3/8"	Polypropylene	White	3874-1	3874-3
Accommodates 7535A (7/8") bailer plug						Black	3874A1	—
1-1/2" I.D.	3-1/2"	1-1/4"	3"	1-7/8" to 2"	Polypropylene	White	3875-1	3875-3
Accommodates 7535A (7/8") bailer plug						Black	3875A1	—
2" I.D.	3-1/2"	1-1/4"	3"	1-7/8" to 2"	Polypropylene	White	3845-1	—

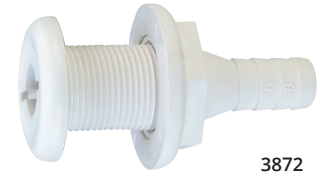

3872

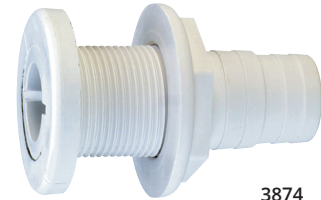

3874



3875



3875B

Thru-Transom Thru-Hull Connector

For installation through the transom. Ideal for overflow use in livewell installations. Can be used with the 3876 Scupper Valve in self-bailing applications, or as an exhaust port for a bilge pump. Polypropylene construction.

Caution: Plastic Thru-Hull Connectors are designed for installation above the water line only.

Fits Hose Size	Stem Length	Max Hull Thickness	Flange Diameter	Installation Hole Saw Size	Color	OEM Part #	Part #
1-1/2" I.D.	5-1/2"	3-1/8"	2-3/4"	2"	White	3875B1	—

Double Ended Thru-Hull Connector

Double-Ended Thru-Hull provides watertight transition through bulkheads or tanks. 5" overall length. Polypropylene construction.

Caution: Plastic Thru-Hull Connectors are designed for installation above the water line only.

Fits Hose Size	Max Hull Thickness	Installation Hole Saw Size	OEM Part #	Part #
3/4" I.D.	1-1/8"	1-1/8"	3878-1	3878-3



3878

90° Thru-Hull Connectors

90° Thru-Hulls are ideal for tight installations, such as livewell overflow drains. Design eliminates hose kinking. Polypropylene construction.

Caution: Plastic Thru-Hull Connectors are designed for installation above the water line only.

Fits Hose Size	Max Hull Thickness	Flange Diameter	Installation Hole Saw Size	Color	OEM Part #	Part #
3/4" I.D.	1"	1-1/2"	1"	White	3877-1	3877-3
Accommodates 7533A (1/2") bailer plug				Black	3880-1	—
1-1/8" to 1-1/4" I.D.	1-7/8"	2-7/16"	1-5/16"	White	3879-1	3879-3
Accommodates 7535A (7/8") bailer plug				Black	3870-1	—



3877

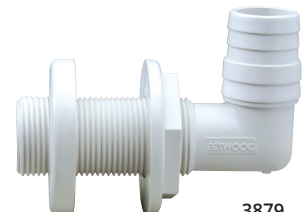

3879

Scupper Valve

Provides a water exit for boats with self-bailing cockpits. Acetal construction. Accommodates 3875B thru-transom thru-hull connector (screw holes must be drilled for installation.) Diameter: 2-7/8". Use as a replacement valve for 3881 Thru-Transom Scupper.

Caution: Plastic Thru-Hull Connectors are designed for installation above the water line only.

Description	OEM Part #	Part #
Valve	3876-1	3876-3



3876

Thru-Transom with Scupper

The rubber flapper opens to drain water out and closes to prevent backwash. Acetal construction. For 1-1/2" I.D. hose.

Caution: Plastic Thru-Hull Connectors are designed for installation above the water line only.

Description	Dimensions	Max Hull Thickness	Installation Hole Saw Size	OEM Part #	Part #
Thru-transom with scupper	6-1/4" L x 2-7/8" dia.	3-1/8"	2"	3881-1	—
Service Part Kit: Includes outer ring, rubber flapper, four SS screws				3881Kit-1	—



3881

Thru-Hull with Strainer

Thru-hull connector with strainer prevents clogging of the aerator pump. Strainer attaches to threads that extend beyond external retaining nut. Acetal construction.

Caution: Do not use strainer as a thru-hull connector nut replacement.

Description	Hose Size	Max Hull Thickness	Installation Hole Saw Size	OEM Part #	Part #
Thru-hull with strainer	3/4" I.D.	1-7/16"	1-1/16" to 1-1/8"	3886-1	3886-3



3886

Drains, Drain Plugs & Tubes

Mesh Strainer/Drain Filter

Durable strainers to prevent debris from clogging baitwell drains and aerator pumps. Two types of construction: formed stainless steel wire mesh molded into black PVC plastic base or acetal plastic.

Caution: Aerator pump must be secured with aerator attachment nut prior to installing strainer.

Description	Thread	Application	OEM Part #	Part #
Stainless Steel mesh	7/8"- 9 UNC2-B	Fits 3877-1 thru-hull	11524-1	11524-3
	3/4"-14 NPSM	Fits 3/4" aerator inlet and 3886-1 thru-hull	4232-1	4232-7
Molded plastic	3/4"-14 NPSM	Fits aerator inlet and 3886-1 thru-hull	3885-1	3885-3



11524



3885

Cockpit Drains

For use with 1-1/2" I.D. hose as part of a self-bailing cockpit system. Features short stem and narrow flange for installing through cockpits. Polypropylene construction.

Description	Stem Length	Max Hull Thickness	Flange Diameter	Installation Hole Saw Size	OEM Part #	Part #
Drain	3-3/4"	1-1/2"	2-1/8"	1-7/8"	3875C1	—
Drain with screen	4-3/32"	1-7/32"	2-1/8"	1-7/8"	3882-1	—



Drain Fittings

These drain fittings can be used with a hose connector to create a drain. Use 3888 with 3899 or 3890 threaded/hose-to-barb connector. Use 3889 with 3891 threaded/hose-to-barb connector. Acetal construction.

Description	Dimensions	Max Hull Thickness	Installation Hole Saw Size	OEM Part #	Part #
3/4" diameter	1-1/2"	1-1/8"	1-1/16" to 1-1/8"	3888-1	—
1-1/8" diameter	1-1/2"	1-1/16"	1-7/16" to 1-1/2"	3889-1	—



Drain Cover

Polished stainless steel drain cover can be used for floor drains, vents, or hidden horn openings. Four holes for #6 fasteners.

Description	OEM Part #	Part #
Stainless Steel, 3-1/4" dia.	66308-1	66308-3



Drain Plug and Receiver Kit

Molded black plastic with threaded receiver. Molded retaining strap. Includes attaching screws and elastomeric gasket for a watertight fit.

Description	OEM Part #	Part #
3/4" dia. one piece plug	17209-1	17211-3



Garboard Drain Plugs

Provides bilge drainage when hauling out. Nut removes with wrench or pliers. Machined, tapered pipe threads ensure watertight plug fit. 3/8" neck depth. Three countersunk holes for #8 fasteners.

Description	Construction	OEM Part #	Part #
1/2" NPT drain	Cast bronze	7555-1	7555-3
Replacement plugs, Pair	Brass	9842-1	9842-3
Replacement plugs, 24 Pair	Brass	—	9842PD1
Replacement plugs, 12 Pair (Saltwater Use)	Stainless Steel	—	9844PD2



Stainless Steel Garboard Drain Plugs

Threaded removable plug. Retention system keeps plug from getting lost. Large 7/8" (27mm) hole for servicing stern drives. High polished #316 stainless steel reduces corrosion.

Description	Construction	OEM Part #	Part #
7/8" diameter	Stainless Steel	7557-1	7557-7
7/8" diameter	Stainless Steel with Gasket	7557G1	—



T-Handle Drain Plugs

For 1" diameter drains. A clockwise turn of the T-handle expands the plug to lock in place; turn counterclockwise to release. Available in brass or stainless steel, with or without chain.

Description	OEM Part #	Part #
Brass Handle		
Without chain	7526A1	7526A7
100 units (w/o chain) in battery box display One UPC sheet for use with all 100 units	—	7526D1
12 units (w/o chain) in PDQ display carton	7526PD1	7526D2
Brass Plated Handle		
Without chain	—	11592-3
Stainless Steel Handle		
Without chain	—	7518A3
12 units (w/o chain) in PDQ display carton	7518PD2	7518PD2



Snap-Handle Drain Plugs

Snap-handle drain plugs for 1" diameter drains. A clockwise turn of the handle tightens the plug in its tube, and the handle flips down to lock. Available in brass or stainless steel, with or without chain.

Description	OEM Part #	Part #
Brass Handle		
Without chain	7524A1	7524A7
With 5" chain	7524B1	—
75 units (w/o chain), battery box display, one UPC sheet for use with all 75 units	—	7524D1
12 units (w/o chain) in PDQ display carton	7524PD2	7524PD2
Brass Plated Handle		
Without chain	—	11591-3
24 units (w/o chain) in PDQ display carton	—	11586-4
Stainless Steel Handle		
Without chain	7520A1	7520A3
12 units (w/o chain) in PDQ display carton	—	7520PD2



Livewell/Bailer Drain Plugs

Cam-action neoprene plugs snap shut to form stopper for livewells / baitwells. Clockwise turn of the handle tightens plug, lever flips down to lock. Ideal for livewell drains. Brass snaps and plates. Note: Not for use with chemicals or fuels.

Description	OEM Part #	Part #
For 7/16" I.D. thru-hull	—	7532A3
For 1/2" I.D. thru-hull	7533A1	7533A7
12 units for 1/2" thru-hull in PDQ display carton	7533PD2	7533PD2
For 5/8" I.D. thru-hull	7534A1	7534A3



Drain Tubes

Drain tubes for 1" diameter drain plugs. Use aluminum drain tubes with aluminum-handle drain plugs; use brass tubes with brass-handle plugs and stainless steel plug handles. Tubes have .032" wall thickness.

Description	Length	OEM Part #	Part #
Brass Drain Tube	1-7/8"	7566AR1	—
	2-3/8"	7566BG1	—
	3"	11446-1	—



In-Line Blowers

Turbo In-Line Blowers

The first vane axial-flow fan bilge blowers designed using aerospace technology to maximize performance. No other bilge blowers in the industry provide such powerful system output at such low power input in a compact size.

- Patented in-line design – provides ventilation for engine compartments, galleys, bilges, and heads
- System airflow exceeds old-style in-line blowers by as much as 25%
- Draws up to 40% fewer amps, making our Turbo blowers up to four times more efficient than competitive blowers
- Marine ignition protected

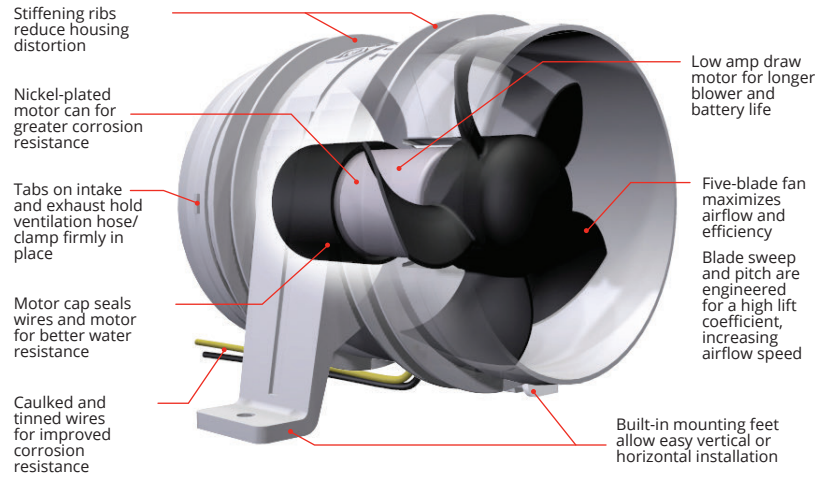

Pump Dimensions

Model No.	A	B	C	D
Turbo 3000	3-5/8"	4-1/2"	5-1/16"	3"
Turbo 4000	4-17/32"	5-1/2"	6-1/16"	4"

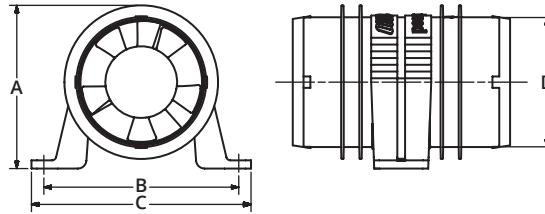

Specifications

Model No.	Rated Voltage	CFM Open Flow	CFM In System*	Current Draw Amps	Fuse Size	Wave Length
Turbo 3000	12V nominal	120	90	2.6	4A	7-1/2"
	13.6V design	145	100	3.1	4A	7-1/2"
Turbo 4000	12V nominal	200	100	2.5	5A	7-1/2"
	13.6V design	230	125	2.9	5A	7-1/2"
	24V nominal	200	100	1.5	3A	7-1/2"
	27.2V design	230	125	2.0	3A	7-1/2"

Turbo 3000 Series

For 3" I.D. ventilation hose. Install with #10 fasteners. Individual carton includes 2 tie straps.

Model No.	Description	OEM Part #	Part #
Turbo 3000	Standard, 12V, White, 1-year Warranty	1731-1	1731-4
	Water-resistant, 12V, White, 3-year Warranty	1733-1	1733-4

Turbo 4000 Series II

Our 4000 Series II blower system matches air flow of existing in-line blowers at a significantly reduced noise level. For added durability, Attwood incorporates an engineered plastic housing that resists deformation during installation and prevents blade to housing interference. For 4" I.D. ventilation hose. Install with #10 fasteners. Individual carton includes two tie straps.

Model No.	Description	OEM Part #	Part #
Turbo 4000	Standard, 12V, White, 1-year Warranty	1747-1	1747-4
	Water-resistant, 12V, White, 3-year Warranty	1749-1	1749-4
	Water-resistant, 24V, White, 3-year Warranty	1751-1	—



Note- In system = 3 ft. of duct with one 90° bend, a collector box and louvered vent on discharge side of blower at 13.6V DC

Vents & Collector Boxes

Attwood hull-mounted vents are designed to install by fastening as a complete unit from either inside or outside the hull. Ventilation hose (not included) twists into the bottom of the box to form a raised water barrier. Plastic vents are corrosion-resistant and will not discolor. All collector boxes and vents are designed for intake or exhaust and meet ABYC H-2 cross sectional area requirements.

Stainless Steel Louvered Vent

All-welded #304 Stainless Steel construction with polished finish. Install with #8 fasteners. Requires collector box 1487A for 3" system, or 1487B for 4" system.

For use with Collector Box(es)	Dimensions	OEM Part #	Part #
1487A, 1487B	3-1/4" x 10-3/8"	1488-1	1488-5

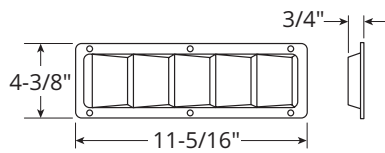

1488

Collector Boxes

Collector boxes for use with 1488 stainless steel vent. Available with cut-out for two 3" I.D. wire-supported hoses or one 4" I.D. wire-supported hose. Corrosion-resistant plastic.

Description	Depth	Installation Hole Saw Size	For Use with Vent(s)	OEM Part #	Part #
For two 3" I.D. hoses	5-9/16"	3-5/8" x 10-3/4"	1488	1487A1	—



1487A

Narrow Stainless Steel Louvered Vents

Suitable for installation on any flat or most contoured hulls. Constructed of all-welded #304 Stainless Steel with a polished finish. Vents for use with 3" I.D. ventilation systems, and require a 1343 collector box. Install with #6 fasteners.

For use with Collector Box	A Depth	Open Hole Size	OEM Part #	Part #
1343	9/16"	2-1/16" x 15-15/16"	1493-1	1493-5
1343	1/16"	2-1/16" x 15-15/16"	1499-1	1499-5

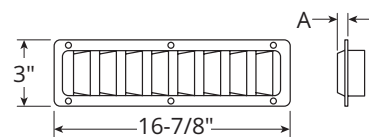

1493



1499

Collector Box

For use with narrow stainless steel vents (1493 or 1499), with two 3" I.D. wire-supported ventilation hoses. Corrosion-resistant plastic.

Description	Depth	Installation Hole Saw Size	For Use with Vent(s)	OEM Part #	Part #
For two 3" I.D. hoses	4-1/16"	2-7/16" x 16-3/16"	1493, 1499	1343-1	—



1343

Venturi Vents

Clean, contemporary, louver design. Corrosion-resistant, paintable ABS plastic. For 3" or 4" I.D. ventilation system. Requires 1341 collector box for 3" system, or 1342 for 4" system. Install with #8 fasteners. Sized for installation even on highly-contoured decks.

For use with Collector Box	Description	Open Hole Size	OEM Part #	Part #
1341, 1342	Black	2" x 15-3/8"	1494A1	1494A5
	White	2" x 15-3/8"	1494F1	—

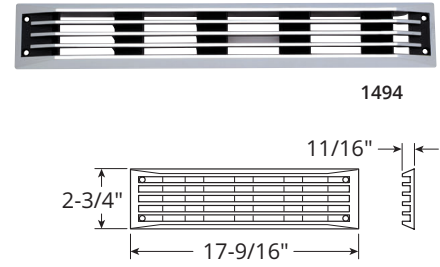

Flush Louvered Vents

Canted louvers deflect rain and spray and help conceal the collector box. Installs flush to hull. Drain slots to prevent water accumulation. Black vent is ABS plastic, white vent is ASA plastic. Both are paintable. Install with #8 fasteners. Requires 1341 collector box for 3" system, or 1342 for 4" system.

For use with Collector Box	Description	Open Hole Size	OEM Part #	Part #
1341, 1342	Chrome	2" x 15-1/4"	1426-1	1426-5
	Black	2" x 15-1/4"	1423-1	1423-5
	White	2" x 15-1/4"	1425-1	1425-5

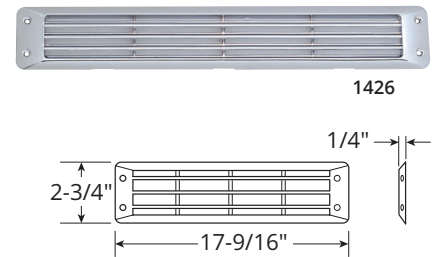

Collector Boxes

For use with Venturi, Flush Louvered or Trimline Vents. Corrosion-resistant plastic.

Description	Depth	Installation Hole Saw Size	For Use with Vent(s)	OEM Part #	Part #
For two 3" I.D. hoses	3-7/8"	2-1/16" x 15-9/16"	1494, 1423, 1424, 1425, 1426, 1496A	1341-1	—
For one 4" I.D. hose	5"	2-1/8" x 15-5/8"	1494, 1423, 1424, 1496A	1342-1	—

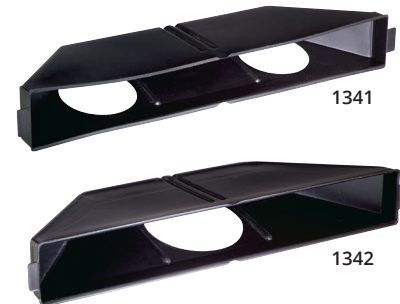

Plastic Louvered Vents

Constructed of paintable, corrosion-resistant ABS plastic with no sharp edges. For 3" I.D. ventilation system with 1345 collector box. Install with #8 fasteners.

For use with Collector Box	Description	Open Hole Size	OEM Part #	Part #
1345	Chrome Plated	2-1/4" x 16"	1495B1	1495B5
	Black	2-1/4" x 16"	1495A1	—
	Off-White	2-1/4" x 16"	1495-1	—

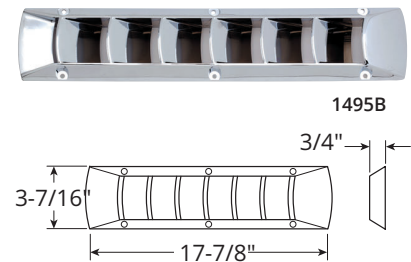

Collector Box

For use with plastic louvered vent, with two 3" I.D. wire-supported ventilation hoses. Box fastens to vent with screws or pop rivets, then vent fastens to the deck. Corrosion-resistant plastic.

Description	Depth	Installation Hole Saw Size	For Use with Vent(s)	OEM Part #	Part #
For two 3" I.D. hoses	4"	2-7/16" x 16-1/4"	1495	1345-1	—



Modular Vents

Modular construction to accommodate any ventilation opening size by interlocking two or more center sections. End sections interlock to the center section for a finished appearance. For 4" I.D. ventilation systems using one or more 1348 collector boxes. End sections have two holes for #8 fasteners.

Description	Color	Open Hole Size	OEM Part #	Part #
Center Sections	White	2-1/2" x 17-3/4"	1438F1	—
End Sections	White	2-1/2" x 17-3/4"	1439F1	—

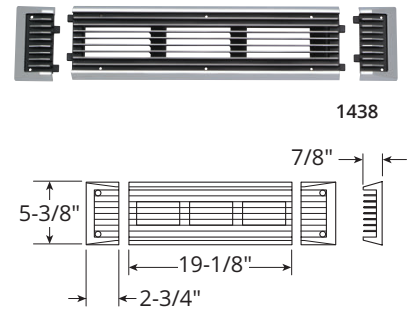

Collector Box

For use with modular vents, with 4" I.D. wire-supported ventilation hose. Corrosion-resistant plastic.

Description	Depth	Installation Hole Saw Size	For Use with Vent(s)	OEM Part #	Part #
For two 4" I.D. hoses	5"	2-3/4" x 18"	1438, 1439	1348-1	—



Cowl Ventilator

For use with 3" I.D. wire-supported ventilation hose. Flexible hose flange is screwed onto hose, then vent snaps onto the flange. Vent constructed of chrome-plated zinc. Flange is non-corrosive plastic. Installs with #8 fasteners.

Description	Installation Hole Size	OEM Part #	Part #
5-5/16" W x 6" L x 2-1/4" H (neck extends 1" below deck)	3-1/4" x 3-1/2"	1364A1	1364A3



Twist-On Hose Flange

For use with 3" I.D. wire-supported ventilation hose. Hose installs from top side by turning the flange into the hose spiral, passing the hose through the deck hole, then mounting ventilator. No hose clamps needed. Corrosion-resistant plastic. Four holes for required #10 fasteners.

Description	Installation Hole Size	OEM Part #	Part #
Twist-On Hose Flange, Black	3.5"	1405-1	1405-3



Storage Vent

Use to vent lockers and storage areas. Provides over six square inches of ventilation opening. Will not accept a ventilation hose. Corrosion-resistant plastic. Two holes for required #6 fasteners.

Description	Height	Neck	Flange Dia.	Installation Hole Size	OEM Part #	Part #
Black	1-1/16"	5/8"	3-3/16"	3-1/16" to 3-1/8"	1353-1	—



Clamshell Vent

Provides a seal and splash protection for vent holes, wire and hose openings. Sizes to fit most common applications. Durable 300 series stainless steel construction. Three holes for required #6 fasteners.

Specifications

Vent Width	Size	Max Hole Size	Hose/Wire Max Size	Fasteners Size
1-3/16"	1-9/16" L x 1/2" H	1"	7/16"	#6
2-3/16"	2-1/4" L x 9/16" H	1-1/2"	9/16"	#6

Description	Dimensions	OEM Part #	Part #
Stainless Steel	1-3/16"	66399-1	66399-3
	2-3/16"	66400-1	66400-3



LIGHTING

Sidelights



45

Attwood Sidelights are designed with top quality materials, providing efficient light output, style, and durability.

All-Round Lights & Bases



54

Attwood offers a wide selection of durable, stowaway, pole-mounted lights. Choose the style of light head, lens and pole to fit a base suited to your installation location.

Anchor/Masthead Lights



65

Innovative, robust, and easy to use, our anchor/masthead lights are designed to achieve 360* visibility, while drawing a fraction of the power of traditional incandescent lights.

LIGHTING

Transom Lights

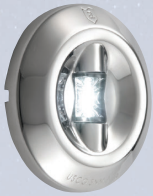

66

For pleasure crafts up to 164 ft. (50 m) in length, transom lights provide reliability and efficiency to illuminate the waters below.

LED Lights



67

Attwood LED navigational lights offer premium materials, robust construction, durability, and sleek design. Built to stand the test of time, with 50,000+ hours of use.

Light Accessories

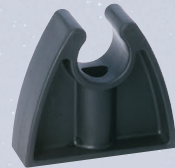

73

Protect your lights with Attwood's replacement parts that are easy to install and maintain.



Navigation Overview

Lighting the Way

Types of Navigation Lights

This section is divided into four basic types of navigation lights, differentiated by lens color, beam angle (horizontal cut-off angle), and location on the boat. All lights are for 12V DC applications only. Styles may vary, but the color, cut-off angle, and location must always comply with the following standards:

Sidelights



Color: Red (port) and/or Green (starboard).

Cut-off: From dead ahead to 112.5° aft on either side of center line (225° total horiz. arc).

Mounting: As far fore as possible.

All-Round Lights



For boats less than 12 m (39.4 ft.). The white all-round light may be used in lieu of a masthead or transom light.

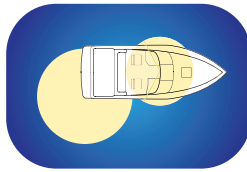

Color: White.

Cut-off: Unbroken arc of 360° on the horizon.

Mounting: As near to the fore and aft centerline as possible

Anchor/Masthead Lights



Color: White.

Cut-off: Unbroken arc from dead ahead to 112.5° aft on either side of center line (225° total horizontal arc), plus 135° dead astern

Mounting: Placed over the fore and aft centerline.

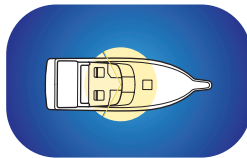

Transom Lights



Color: White.

Cut-off: Unbroken horizontal arc of 67.5° each side dead astern (135° total horizontal arc).

Mounting: As far aft as possible.

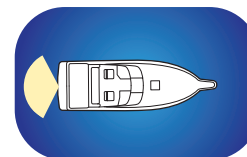

Certifications, Codes, and Standards

This section provides you with some general information on the selection and installation of navigation lights for pleasure boats of 20 m (65.6 ft.) or less. For details refer to: ABYC A-16, 72 COLREGS, Inland Navigation Rules, U.S. Code of Federal Regulations Title 33 Part IP, or international regulations. The following Attwood navigation lights are NMMA listed and meet 72 COLREGS as noted.



This symbol indicates Attwood navigation lighting products that have been certified according to the latest U.S. Coast Guard regulations.

Model No.	NMMA No.	Meets 72 COLREGS	Meets ISO 19009:2015
3900 Series	91508	YES	NO
5100 Series	91511	YES	NO
5300 Series	91512	YES	NO
5600 Series	2528266	YES	NO
5900 Series	91518	YES	NO
5940 Series	91515	YES	NO
6356D	91420	YES	NO
66382	91425	YES	NO
7100 Series	91520	YES	NO
7200 Series	2456711	YES	NO
7400 Series	2456711	YES	NO
LED Lights			
2500 Series	2515284	YES	NO
NV1002 SERIES (2NM)	2593399	YES	YES
NV1001 SERIES (1NM)	2597456	YES	YES
NV1012 SERIES (2NM)	2593400	YES	YES
NV1011 SERIES (1NM)	2597457	YES	YES
NV2002 SERIES (2NM)	2593401	YES	YES
NV2001 SERIES (1NM)	2597458	YES	YES
NV2012 SERIES (2NM)	2593402	YES	YES
NV2011 SERIES (1NM)	2597459	YES	YES
NV3012 SERIES (2NM)	2593409	YES	YES
NV3011 SERIES (1NM)	2597462	YES	YES
NV4012 SERIES (2NM)	2593410	YES	YES
NV4011 SERIES (1NM)	2597463	YES	YES
NV5012 SERIES (2NM)	2593411	YES	YES
NV5011 SERIES (1NM)	2597464	YES	YES
NV0002P (2NM)	2593407	YES	YES
NV0001P (1NM)	2597460	YES	YES
NV0002S (2NM)	2593408	YES	YES
NV0001S (1NM)	2597461	YES	YES
NV6LC1 SERIES (2NM)	2593403	YES	YES
NV6LC2 SERIES (2NM)	2593404	YES	YES
NV6SP1 SERIES (2NM)	2593405	YES	YES
NV6SP2 SERIES (2NM)	2593406	YES	YES
5530 Series	2459732	YES	NO
5540 Series	2459733	YES	NO
5550 Series	2459733	YES	NO
5580 Series	2501760	YES	NO
7800 Series	2459859	YES	NO
6556 Series	2459860	YES	NO

Boats at Anchor

When anchored in other than designated areas, any boat under 50 m (164 ft.) must have a 360° white light in view (a single all-round light, a masthead and transom light, or other means).

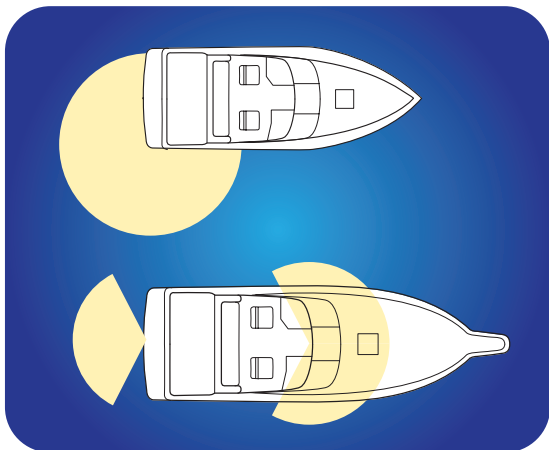

Vertical Separation of Lights

Pole length and location determines light separation. On boats under 12 m (39.4 ft.), the all-round or masthead light must be located a minimum of one meter (39-3/8") above the red-green sidelights. One meter must be the height separation measured from bulb filament centers.

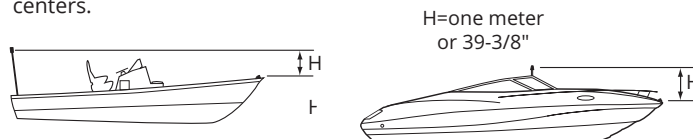

On boats of 12 to 20 m (39.4 to 65.6 ft), the masthead light must be at least 2.5 m (8.2 ft) above the gunwale.

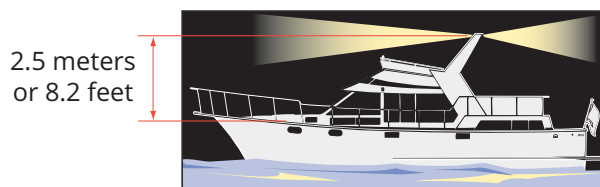

Boats Underway

This section outlines the navigation lighting required according to current U.S. Coast Guard and 72 COLREGS (International Waters) regulations. When underway, the required navigation lights are:

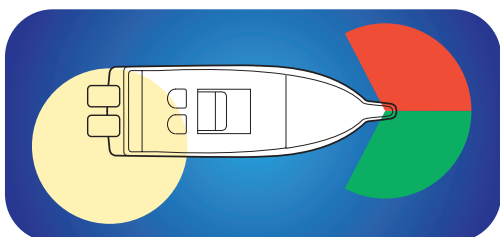

Power-driven boats less than 12 m (39.4 ft.) with max. speed over 7 knots:

- Sidelight pair or combined—1 mile
- All-Round Light—2 mile or Masthead Light—2 mile with Transom Light—2 mile.

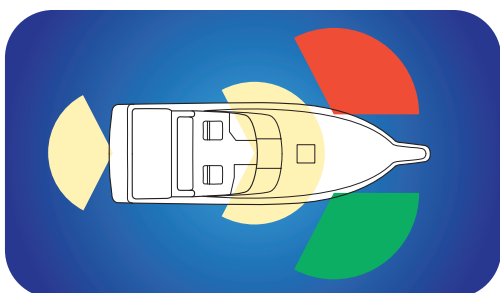

Power-driven boats 12 to 20 m (39.4 to 65.6 ft.):

- Sidelight pair or combined—2 mile
- Masthead Light—3 mile and Transom Light—2 mile.
- All-Round Light may not be used.

Sailboats Under Motor Power:

When under power, sailboats are considered power boats and must operate with power boat lights as previously outlined.

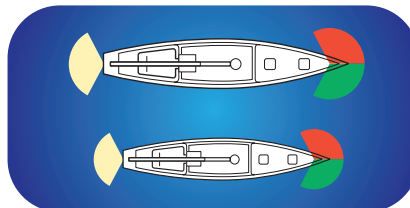

Sailboats less than 7 m (23 ft.) under sail:

- Sidelight pair or combined—1 mile
- Transom Light—2 mile
- Flashlight or lighted lantern.

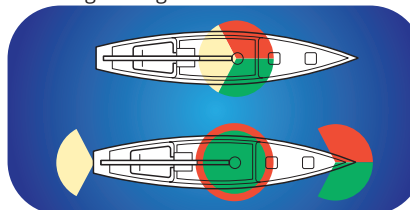

Sailboats 7 to 20 m (23 to 65.6 ft.) under sail:

Three different light configurations may be acceptable:

1. Sidelights & Transom Light.
2. A Sidelight & Transom Light combined in one light (a Tri-Color Light) mounted at or near top of mast.
3. Sidelights & Transom Light, or two All-Round Lights, mounted at or near the top of the mast, the upper light being red and the lower green.

Small, Oar-Driven Boats:

- Sidelight pair or combined—1 mile
- Transom Light—2 mile
- Flashlight or lighted lantern.
- Various other light requirements are outlined in the standards regarding towing, vessels aground, and other special conditions
- Consult the Inland Navigation Rules, 72 COLREGS, or USCG for details.

Why Attwood LED?

A New Level of Efficiency

Through the use of proprietary optical design techniques, we've optimized our lens design to harness nearly 90% of all light being generated by the LED. In doing so, our line of LED series navigational lights exceed U.S. Coast Guard requirements with the fewest and lowest watt LEDs of any navigational light manufactured today. Less energy used by navigational lighting means more energy available for powering your boat and enjoying time on the water.

Engineered to Last

As the emerging leader in marine lighting design, Attwood understands the demands of the marine environment. Completely sealed LED units resist water intrusion, electrostatic discharge (during assembly), vibration and ultraviolet light (UV) radiation. Reverse polarity protection has been added to eliminate potential mis-wiring damage during installation. Our LED navigational lighting also features high-quality, electro-polished stainless steel covers designed to resist corrosion in even the most extreme saltwater environments. The result? Style and durability. Most importantly, Attwood lights are built to stand the test of time. Rated for 50,000+ hours of use, you can count on Attwood products to light your way for years to come.

LED Light Engine

Positioned and sealed inside a lens assembly, the "light engine" serves as the equivalent of an LED (Light Emitting Diode). It can be easily customized to meet the needs of a builder in terms of attachment scheme and overall dimensions.



Ready for the Global Market

- EN/ISO 19009:2015
- ABYC A-16
- 1972 COLREGS
- RCD 2013/53/EU
- USG 33 CFR

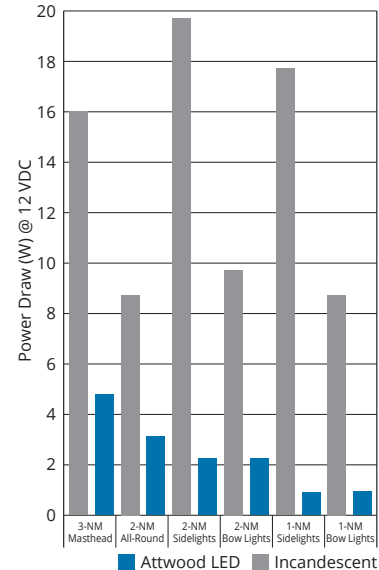
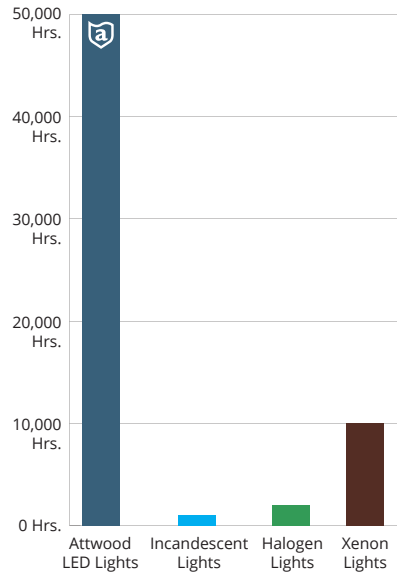

Choice of Electrical Connectors

Attwood lights feature several wire attachment styles to adapt to your boat's wiring harness. Standard wire on all lights are tinned and caulked.

Special connectors are available on special order by contacting your Attwood representative. Minimum order quantity is 250.

Brown - Positive, Black - Negative, Brown & White - Manual Override



Deck Mounted Sidelights

LIGHTARMOR™

LED Navigation Lights: 1-Mile/2-Mile

LightArmor Navigation Lights have all the characteristics that signifies the premium LightArmor brand: top-quality materials, robust construction, durability, and sleek design

- Meets today's global regulatory requirements, including EN/ISO 19009:2015
- Proprietary modular LED light engine technology
- Design flexibility and ease of installation

Deck Mount Lights



1-Mile Lights For use on boats up to 39.4 ft (12 m) in length.

Description	OEM Part #	Part #
Stainless Steel		
1-NM, Oval, Bi-Color	NV1001SS-1	—
1-NM, Oval, Red/Green, Pair Sidelights	NV1011SS-1	—
1-NM, Round, Bi-Color	NV2001SS-1	—
1-NM, Round, Red/Green, Pair Sidelights	NV2011SS-1	—
Black Composite		
1-NM, Oval, Bi-Color	NV1001PB-1	—
1-NM, Oval, Red/Green, Pair Sidelights	NV1011PB-1	—
1-NM, Round, Bi-Color	NV2001PB-1	—
1-NM, Round, Red/Green, Pair Sidelights	NV2011PB-1	—

2-Mile Lights For use on boats up to 65.6 ft (20 m) in length.

Description	OEM Part #	Part #
Stainless Steel		
2-NM, Oval, Bi-Color	NV1002SS-1	—
2-NM, Oval, Red/Green, Pair Sidelights	NV1012SS-1	—
2-NM, Round, Bi-Color	NV2002SS-1	NV2002SS-7
2-NM, Round, Red/Green, Pair Sidelights	NV2012SS-1	NV2012SSR-7† / NV2012SSG-7†
Black Composite		
2-NM, Oval, Bi-Color	NV1002PB-1	—
2-NM, Oval, Red/Green, Pair Sidelights	NV1012PB-1	—
2-NM, Round, Bi-Color	NV2002PB-1	NV2002PB-7
2-NM, Round, Red/Green, Pair Sidelights	NV2012PB-1	NV2012PBG-7† / NV2012PBR-7†

Vertical Mount Lights

1-Mile Lights For use on boats up to 39.4 ft (12 m) in length.

Description	OEM Part #	Part #
Stainless Steel		
1-NM, Round, Red/Green Pair	NV3011SS-1	—

2-Mile Lights For use on boats up to 65.6 ft (20 m) in length.

Description	OEM Part #	Part #
Stainless Steel		
2-NM, Round, Red/Green Pair	NV3012SS-1	NV3012SSG-7† / NV3012SSR-7†
2-NM, Elliptical, Red/Green Pair	NV4012SS-1	NV4012SSG-7† / NV4012SSR-7†
2-NM, Oval, Red/Green Pair	NV5012SS-1	—
Black Composite		
2-NM, Oval, Red/Green Pair	NV5012PB-1	—

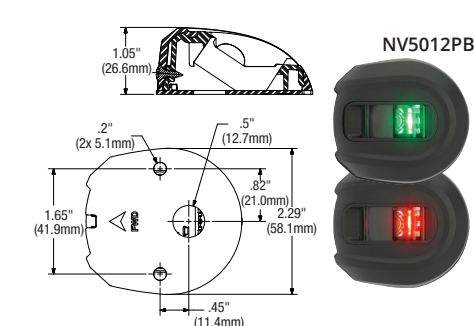
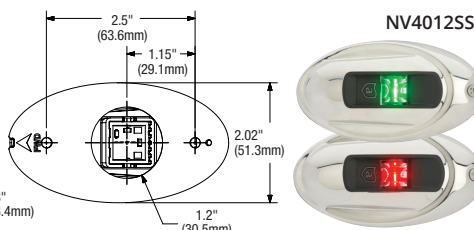
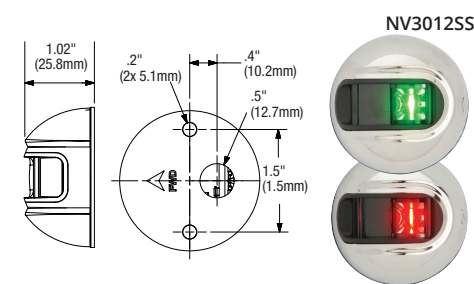
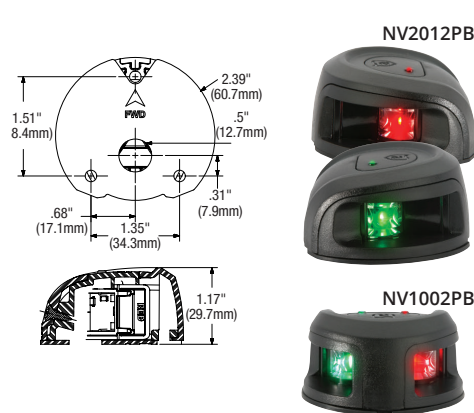
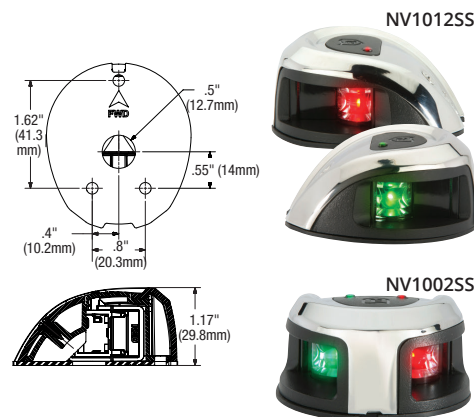

† Red/Green Sidelights packaged separately for aftermarket.

FULSAR 5040 Series 1-Mile Sidelights

Bayonet lock design secures lens and cover to base. Includes a 9W (#906) wedge base lamp and 7" wire leads for connection to 12V DC power supply. Installs directly to deck with two #10 fasteners. Cover and lens conceal installation fasteners and seal water out of lamp and hull. For use on boats up to 39.4 ft. (12 m). 1-mile, 225° light visibility.

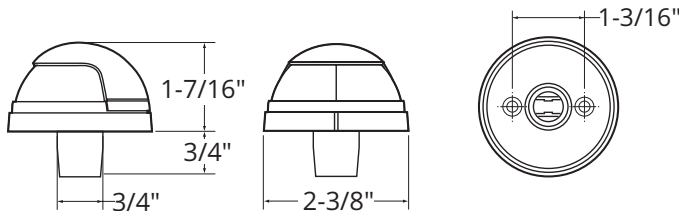
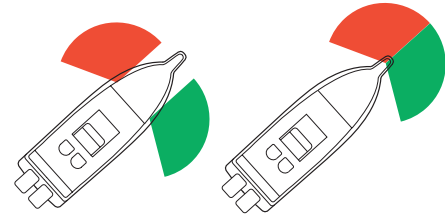

Bi-Color Combination, Deck Mount

Description	OEM Part #	Part #
Black	—	5045-7



Red/Green Pair, Deck Mount

Each light provides 1-mile, 112.5° light visibility. Includes a 9W (#906) wedge base lamp.

Description	OEM Part #	Part #
Black	5040-1	5040R7 [†] / 5040G7 [†]



Red/Green Pair, Raised Base

Ideal for use where light must be elevated for visibility above rails and carpeting. Each light provides 1-mile, 112.5° light visibility. For use on boats up to 39.4 ft. (12 m). Includes a 9W (#906) wedge base lamp.

Description	OEM Part #	Part #
Black	—	5080R7 [†] / 5080G7 [†]

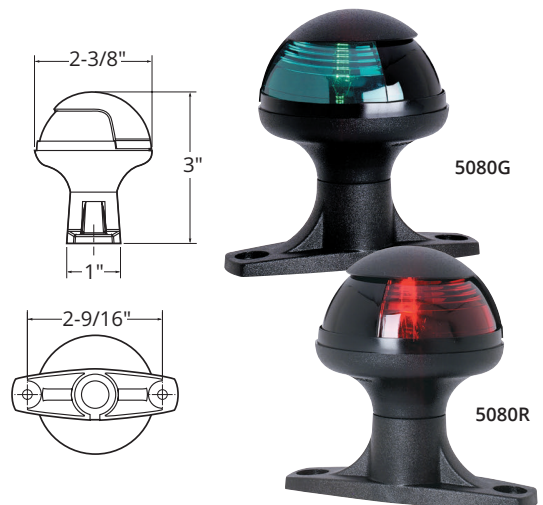

[†] Red/Green Sidelights packaged separately for aftermarket.

Stainless Steel 3800 Series 2-Mile Sidelights

Attwood's 2-Mile Stainless Steel Sidelights are made with a rugged 316 stainless steel cover for outstanding resistance to impact and corrosion. For use on boats up to 65.6 ft. (20 m).

- Smooth contour prevent lines from snagging on housing
- A single external stainless steel lock screw attaches cover to base, permits easy disassembly for servicing
- Stainless steel electrical contacts will not corrode
- Cover design and integral gasket seal out water and make installation and maintenance simple
- Includes efficient, high-output 10W bayonet lamp
- Tinned 7" wire leads make it easier to make a permanent, corrosion-resistant connection

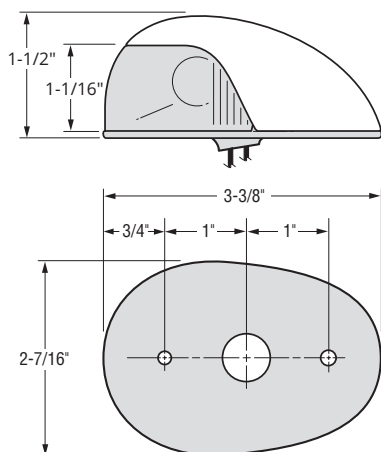
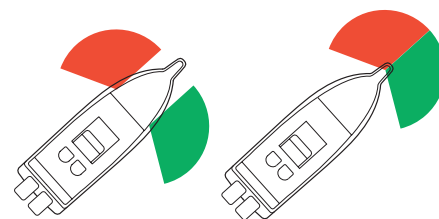

Stainless steel cover and electrical contacts for corrosion resistance and long life

Locking screw for easy assembly and maintenance

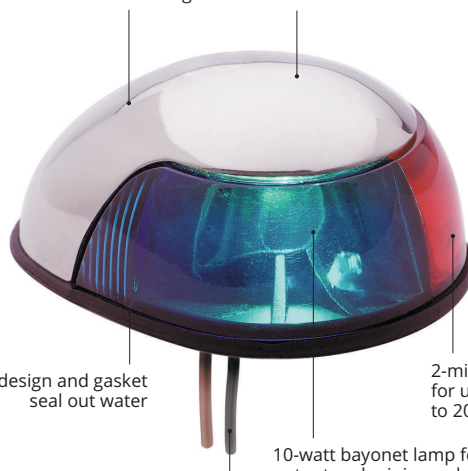

Lens design and gasket seal out water

2-mile light output for use on boats up to 20 meters (65.6 ft.)

Tinned-copper wire leads for easy installation and corrosion resistance

10-watt bayonet lamp for high output and minimum heat

Bi-Color Combination, Deck Mount

2-mile, 225° light visibility.



Description	Rated Voltage	OEM Part #	Part #
Stainless Steel	12V	3810-1	3810-7



3810

Red/Green Pair, Deck Mount

Each light provides 2-mile, 112.5° light visibility.



Description	Rated Voltage	OEM Part #	Part #
Stainless Steel	12V	3820-1	3820R7 [†] / 3820G7 [†]



3820G

3820R

[†] Red/Green Sidelights packaged separately for aftermarket.

Vertical Mount 3800 Series 2-Mile Sidelights

Visibility, Style, and Durability

- Clean, contoured shape blends into hull making the light less noticeable and providing an integrated look with the boat
- Choice of cover colors includes: black, white, or 316 stainless steel
- Rugged stainless steel internal components for corrosion-free performance
- 2-mile output for boats to 20 m (65.6 ft.)
- Tinned 7" wire leads make a permanent, corrosion-resistant connection

Contoured Styling

Matches the 3800 Series 2-Mile Horizontal Mount Sidelights. Provides builders with a family styling for navigation lights between different model offerings.

Durable Construction

The one-piece lens and full-perimeter gasket design make the light virtually waterproof when properly installed. Durable plastic or stainless steel helmet provides rugged protection to the lens and lamp. Internal electrical contacts are stainless steel, so corrosion is not a problem—even in saltwater.

Simple Installation, Small Footprint

Just remove one screw to detach the helmet, and install the base directly to vertical surfaces. Small size makes it simple to install in confined areas. Typical Installation requires: (3) #10 stainless steel screws of length suitable for deck material.

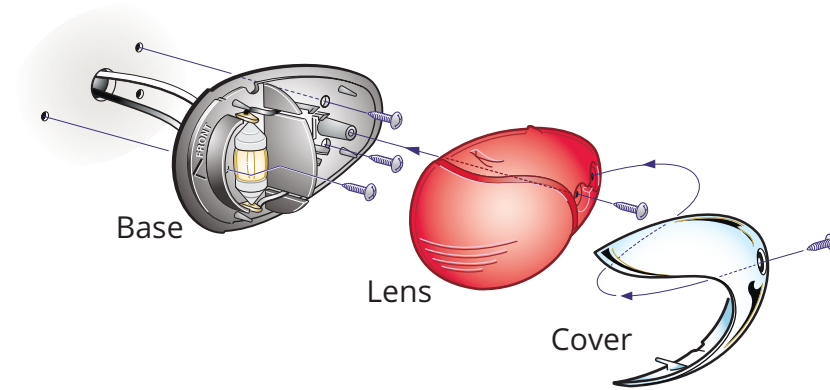
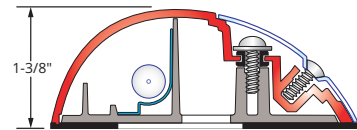
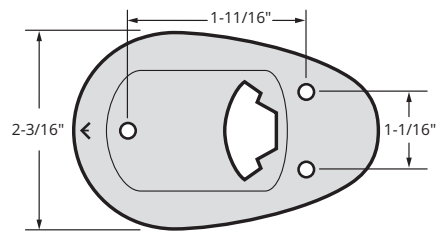
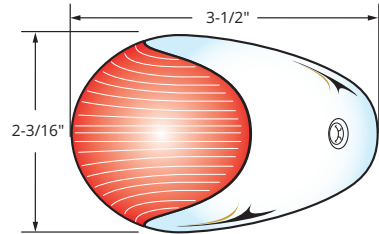
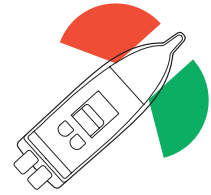

3830-1
(12 red, (12) green in pack)



3838R7 / 3838G7

Red/Green Sidelights, Pair

Each light provides 2-mile, 112.5° light visibility.



Description	Rated Voltage	OEM Part #	Part #
Black Plastic	12V	3830-1	—
Stainless Steel	12V	3838-1	3838R7† / 3838G7†

† Red/Green Sidelights packaged separately for aftermarket.

Stainless Steel 66000 Series 1-Mile Sidelights

Constructed of corrosion-resistant 304 stainless steel, these lights provide 1-mile visibility for power boats up to 39.4 ft. (12 m). Lights include rubber gasket lens seal for enhanced internal corrosion resistance. Includes one 7.5W lamp. For connection to 12V DC power supply.

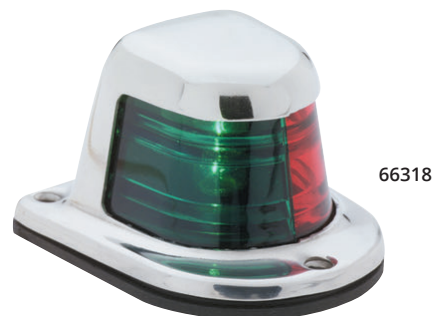
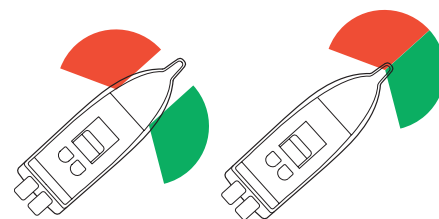
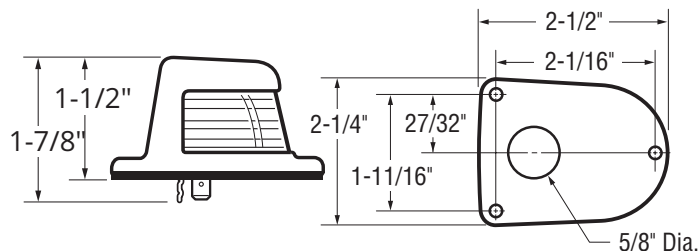

66318

Red/Green Pair, Deck Mount

Installs with three #6 mounting fasteners (not included). Each light provides 1-mile, 112.5° light visibility.

Description	Socket	OEM Part #	Part #
Stainless Steel	7" wire lead	—	66319R7 [†] / 66319G7 [†]



66319R

Bi-Color Combination, Deck Mount

Installs with three #6 mounting fasteners (not included). Provides 1-mile, 225° light visibility.

Description	OEM Part #	Part #
Stainless Steel	—	66318-7

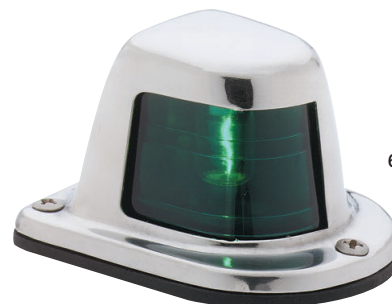

66319G

Zamak 6300 Series 1-Mile Sidelights

These die-cast ZAMAK sidelights with Perma-Plate® finish provide 1-mile visibility for power boats up to 39.4 ft. (12 m). Mounts on decks or gunwales with external screws. Includes 7.5W lamp and 7" hard wire leads for 12V DC electrical connection.

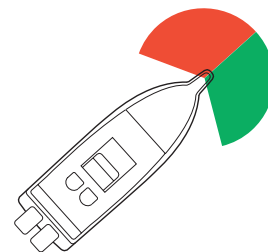

Bi-Color Combination, Deck Mount

Housing completely encases socket. Installs with two #8 fasteners (not included). Provides 1-mile, 225° light visibility.

Description	OEM Part #	Part #
Chrome-Plated ZAMAK	—	6375D6



6375D6

[†] Red/Green Sidelights packaged separately for aftermarket.

Pole-Mounted Plug-In Sidelights

LIGHTARMOR™ LED Bi-Color Navigation Pole Lights

LightArmor Stowaway Pole Lights have all the characteristics that signifies the premium LightArmor brand: top-quality materials, robust construction, durability, and sleek design. Available with task light option.

- Meets today's global regulatory requirements, including EN/ISO 19009:2015
- Proprietary modular LED light engine technology
- 2-mile visibility
- Design flexibility and ease of installation

NOTE: locking collar design is compatible only with LightArmor Plug-In Bases

Bi-Color Pole Lights

Series	Use with Light Base
NV6LC1, NV6SP1	910R2, 901V2, 910T2, 2520*, 911339*, 911370*,

Bi-Color Pole Lights with Task Light

Series	Use with Light Base
NV6LC2, NV6SP2	910R3, 901V3, 910T3, 2530*

* When locking collar is removed.

Description	Pole Length	OEM Part #	Part #
2-Pin, Locking Collar Pole	10" Straight	NV6LC1-10-1	—
	12" Straight	NV6LC1-12-1	—
	14" Straight	NV6LC1-14-1	NV6LC1-14-7
	16" Straight	NV6LC1-16-1	—
	10" Angled	—	NV6LC1-10A7
	14" Angled	—	NV6LC1-14A7
2-Pin, Standard Pole	10" Straight	NV6SP1-10-1	—
	12" Straight	NV6SP1-12-1	—
	14" Straight	NV6SP1-14-1	—
	16" Straight	NV6SP1-16-1	—
3-Pin, Locking with Task	10" Straight	NV6LC2-10-1	NV6LC2-10-7
	14" Straight	NV6LC2-14-1	NV6LC2-14-7
3-Pin, Standard with Task	10" Straight	NV6SP2-10-1	—
	14" Straight	NV6SP2-14-1	—

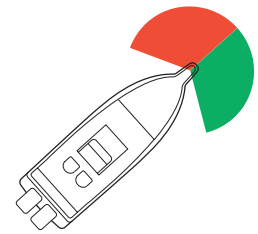

LIGHTARMOR™
Plug-In Bases
See pages 59-61



LIGHTARMOR™ LED Bi-Color Fast Action Navigation Lights

Premium LED lights with a flexible, impact-resistant composite pole make these perfect for anglers and hunters to maneuver through low-hanging obstacles. The subtle, glare-free black matte finish complements many of today's boat designs.

- ISO 19009:2015 Certified
- Impact-resistant polycarbonate lens
- Water resistant
- Corrosion/UV resistant
- LED light engines last for 50,000 hours
- 5-year warranty

Description	Pole Length	OEM Part #	Part #
2-Pin, Locking Collar Pole	10"	NV6LC1-10BP1	—
	12"	NV6LC1-12BP1	—
	14"	NV6LC1-14BP1	NV6LC1-14BP7
3-Pin, Locking Collar Pole	14"	NV6LC2-14BP1	NV6LC2-14BP7



PULSAR 5090 Series 1-Mile Sidelights

Attwood offers a variety of durable, stowaway, combination pole-mounted sidelights for bow mounting. Each features an anodized aluminum pole that raises the light head for visibility above trolling motors, anchors, or other equipment on the bow. When not in use, lights can be removed from base and stowed, so they won't interfere with fishing or anchoring.

Incandescent Bi-Color Stowaway

1-mile, 225° light visibility for boats up to 39.4 ft. (12 m). Includes 9W wedge base lamp.

Series	Use with Light Base		
5091, 5092	910R2, 901V2, 910T2, 2520‡, 911339*, 911370*		
‡When locking collar is removed.			
Description	Pole Length	OEM Part #	Part #
2-Pin Locking-Collar Pole	10" Straight	5092-10T1	5092-10-7
	12" Straight	5092-12T1	—
	12" Straight, Black	5092-12TB1	—
	14" Straight	5092-14T1	5092-14-7
	16" Straight	5092-16T1	—
	20" Straight	5092-20T1	—
2-Pin Standard Pole	10" Angled	5091-10-1	5091-10-7
	12" Angled	5091-12-1	—
	14" Angled	5091-14-1	5091-14-7



Incandescent Bi-Color Stowaway with Task Light

Based on the same great design of the original Pulsar™ Bi-Color Pole Light, the Task Light also gives you a narrow beam work light. It features a durable rubber “push-on” switch and a micro bulb. Attwood's Task Light output is ten times brighter than competitive models, giving today's fishermen the tools they need for serious nighttime fishing.

Series	Use with Light Base		
5095	910R3, 901V3, 910T3, 2530*		
* When locking collar is removed.			
Description	Pole Length	OEM Part #	Part #
3-Pin Locking-Collar Pole	10" Straight	5095-10T1	5095-10-7
3-Pin Standard Pole	10" Straight	5098-10-1	—



2500 Series Horn & Light Base

Ideal solution for today's fishing boat market. Combining both horn and light base components into one integrated module, Attwood's assembly is compact, robust, and easy to install. The acoustic technology provides a louder, more effective, and higher quality sounding product than current industry offerings. Attwood's patent pending water management system efficiently controls water inrush and eliminates the need for a sound reducing cloth at the horn mouth.

Exceptional Sound Quality

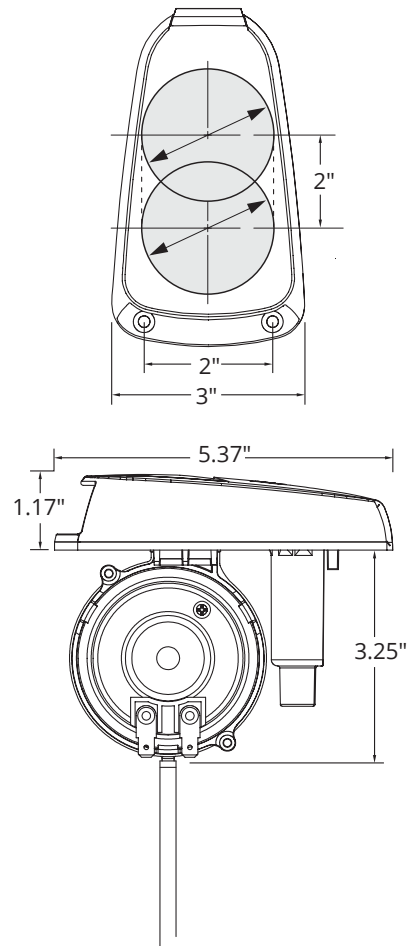
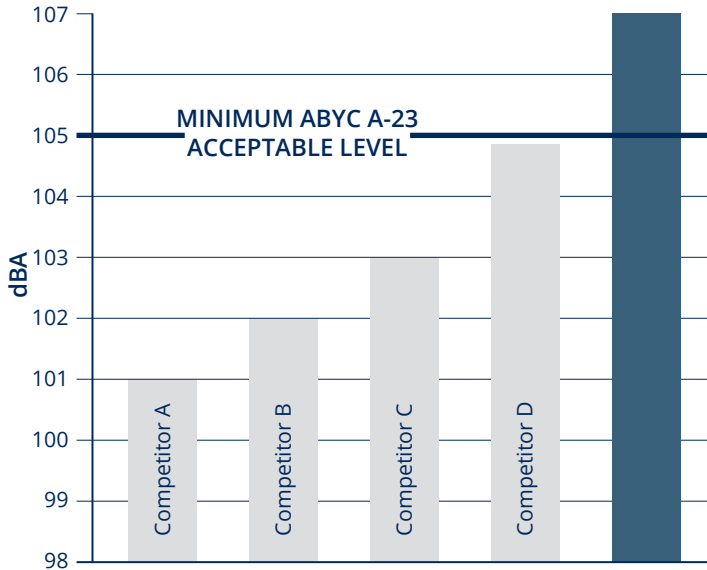

Durable

- Stainless mesh won't tear or puncture like cloth fabric.
- Water management system prevents common horn failures.
- Rubber base cover is flexible to avoid damage if kicked or stepped on.
- Withstands 2500 lb. standing load.
- Horn uses a make/break disc diaphragm to produce a quality tone (The main competitor uses a piezoelectric horn to produce a buzzer sound).

2500 Series Horn & Light Base with Suggested Attwood Pole Lights

Description	Pole Length	OEM Part #	Part #
Horn & Light Base			
2-Wire	—	2520-1	—
3-Wire	—	2530-1	—
Suggested Attwood Pole Lights			
2-Pin, Standard Pole	10" Straight	NV6SP1-10-1	—
	12" Straight	NV6SP1-12-1	—
	14" Straight	NV6SP1-14-1	—
	16" Straight	NV6SP1-16-1	—
3-Pin, Standard with Task	10" Straight	NV6SP2-10-1	—
	14" Straight	NV6SP2-14-1	—



All-Round Plug-In Lights Overview

Attwood offers a selection of durable, stowaway, pole-mounted lights. Plug-in pole lights are available in socket styles to fit most Attwood's 2- and 3-pin bases, and competitive brands of bases when the 2- or 3-pin locking-collar pole is specified.

Pole Light Selection

Simply choose the style of light head and lens you need and select the pole style to fit your existing base. Or select a matching base best suited to your installation location. Black pole option available upon request.



Locking-Collar Pole with Universal Fit

Locking-collar poles offer universal fit allowing customers to use them with a wide variety of Attwood 2- and 3-pin straight or angled bases. They also work as replacements in competitive bases, including Perko® brand bases.

Perko® is a registered trademark of Perko, Inc.

Standard Pole

Standard pole is used on Attwood all-round, masthead, transom, and bi-color pole lights. Fits all Attwood standard (non-locking-collar) 2- and 3-pin contact bases.

2-Mile All-Round Lights

Attwood all-round lights offer 2-mile, 360° visibility and are suitable on boats up to 39.4 ft. (12 m). Power vessels less than 39.4 ft. may show a single all-round light in lieu of a separate masthead and stern light. Attwood all-round lights are available in a variety of head, pole, and base styles to fit most boats and installation locations. On boats under 12 m, the all-round light is the most important navigation light because it can be seen by others from any direction.

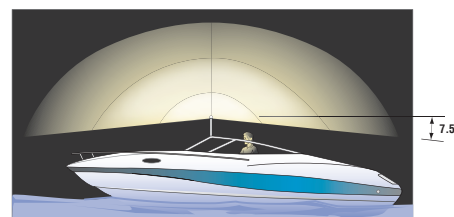

- LED Anti-Glare
- Anti-Glare Lights
- Frosted Globe Lights

Attwood offers a choice of all-round lights — Anti-Glare and Frosted Globe. Select the head, pole, and, base style that best suit your installation location and eliminate driver glare.

Traditional and LED Anti-Glare Lights

Attwood's Anti-Glare All-Round light goes beyond current regulations to reduce the danger of on-board glare. The precision lens focuses the light beam to the horizon where it's needed—360° without diffusion—keeping it out of the driver's field of view. It allows the operator to see while being sure the boat is seen. The bottom aperture eliminates glare by cutting off the light beam at 7.5° below horizontal, so it's out of the driver's view. Above horizontal, the lens shines a continuous arc of light—

allowing improved visibility even when the boat is pitching in rolling seas. The Articulating Anti-Glare Light makes it even easier to eliminate glare. The patented articulating head adjusts from 15° fore to 15° aft to fit all base angles and typical deck installations.

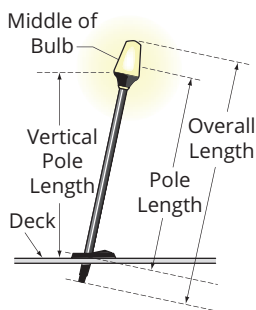

Frosted Globe Lights

Attwood's standard Frosted Globe All-Round light is also available. Offering 360° visibility.

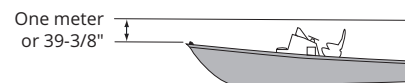

One-Meter Regulation

All-round light must be a minimum of one meter (39-3/8") above the red/green sidelights on boats under 12 m (39.4 ft.). One meter must be the height separation measured from bulb filament centers.

Note: Frosted globe pole lights may be used with straight and angled bases. Unarticulated anti-glare pole lights must be selected to match the appropriate straight or angled base.



All-Round Plug-In Lights

LIGHTARMOR™ LED Fast Action All-Round Navigation Lights

Premium LED lights with a flexible, impact-resistant composite pole make these perfect for anglers and hunters to maneuver through low-hanging obstacles. The subtle, glare-free black matte finish complements many of today's boat designs.

- ISO 19009:2015 Certified
- Impact-resistant polycarbonate lens
- Water resistant
- Corrosion/UV resistant
- Light head adjusts 15° fore to 15° aft
- LED light engines last for 50,000 hours
- 5-year warranty



Threaded Locking Collar fits securely with LightArmor Plug-In Light Bases

2 NM
USCG

Description	Pole Length	OEM Part #	Part #
All-Round Light	24"	5530-24BP1	5530-24BP7
	30"	5530-30BP1	—
	36"	5530-36BP1	5530-36BP7
	42"	5530-42BP1	5530-42BP7
	48"	5530-48BP1	—
	54"	5530-54BP1	5530-54BP7
	60"	5530-60BP1	—

LIGHTARMOR™ LED All-Round Articulating Light

USCG certified. Provides 2-mile 360° visibility for boats up to 39.4 ft (12m)

- LightArmor™ All-Round navigation engine
- 30% lighter than earlier Attwood all-round lights
- Exclusive condensation management increases visibility
- Exclusive anti-glare engine preserves night vision
- Shock-, corrosion-, and water-proof electronics
- Durable, anodized aluminum pole
- Articulating head for use in all applications
- Strong locking-collar secures light in harsh marine conditions
- Standard 2-pin
- Compatible with Attwood and popular bases
- Operating range = 10.5V DC - 14.4V DC
- Over 50,000 hour life
- 5-year warranty



2 NM
USCG

Series	Use with Light Base
5530	910R2, 901V2, 910T2, 2520‡, 911339‡, 911370‡

Description	Pole Length	OEM Part #	Part #
2-Pin Locking-Collar Pole	12"	5530-12T1	—
	24"	—	5530-24A7
	36"	—	5530-36A7
	42"	5530-42T1	5530-42A7
	48"	5530-48T1	5530-48A7
	54"	5530-54T1	5530-54A7
	54", Black	5530-54TB1	—
	60"	5530-60T1	5530-60A7
	66"	5530-66T1	—

‡When locking collar is removed.

LIGHTARMOR™ LED All-Round All-Round Folding Pole Light

USCG certified. Provide 2-mile, 360° visibility for boats up to 39.4 ft. (12 m)

- LightArmor™ All-Round navigation engine
- 30% lighter than earlier Attwood all-round lights
- Exclusive condensation management increases visibility
- Exclusive anti-glare engine preserves night vision
- Shock-, corrosion-, and water-proof electronics
- Durable, anodized aluminum pole
- Standard 2-pin
- Compatible with Attwood and popular bases
- Operating range = 10.5V DC - 14.4V DC
- Over 50,000 hour life
- 5-year warranty

Series	Use with Light Base
5540, 5570	910R2, 901V2, 910T2, 2520‡, 911339‡, 911370‡

‡When locking collar is removed.

Description	Pole Length	OEM Part #	Part #
2-Pin Locking-Collar Pole	54"	5540-54T1	5540-54A7
	60"	5540-60T1	—
	72"	5540-72T1	—
	84"	5540-84T1	—
2-Pin Standard Pole	60"	5570-60-1	—
	72"	5570-72-1	—



Incandescent All-Round Articulating Anti-Glare Light

Attwood's Anti-Glare lights are a great improvement over conventional all-round lights. They focus light at the horizon and above, not in the driver's eyes.

The bottom aperture reduces glare at 7.5° below horizontal. Above horizontal, the lens shines a continuous arc of light in rolling seas. The patented articulating head adjusts from 15° forward to 15° aft. Simply align the lens to the horizon and tighten the adjustment screw. Makes the boat more visible to taller craft such as freighters and commercial vessels.

The All-Round Articulating Anti-Glare Light simplifies inventory for builders and retailers, since one light fits most angles and installations. The locking-collar pole allows installation in 95% of existing bases — Attwood models as well as competitive bases such as Perko® brand, which simplifies installation for consumers.

Perko® is a registered trademark of Perko, Inc.

Series	Use with Light Base
5330	910R2, 901V2, 910T2, 2520* 911339*, 911370*

* When locking-collar is removed.

Description	Pole Length	OEM Part #	Part #
2-Pin Locking-Collar Pole	42"	5330-42T1	5330-42-7
	48"	—	5330-48-7
	54"	5330-54T1	—
	60"	5330-60T1	—
	72"	5330-72T1	—



Incandescent All-Round Folding Pole Light

All-round lights must be at least one meter above sidelights, which requires a longer pole light that is difficult to store for some boats. Attwood's All-Round Folding Pole light solves this problem. It has all the features of the patented Articulating Anti-Glare Light, plus one great advantage — the removable pole folds in half for easy storage.

The mid-point hinge is a corrosion-resistant, glass-filled composite. Wiring is sheathed at the hinge for trouble-free operation.

Series	Use with Light Base
5340	910R2, 901V2, 910T2, 2520* 911339*, 911370*

* When locking-collar is removed.

Description	Pole Length	OEM Part #	Part #
2-Pin Locking-Collar Pole	42"	5340-42T1	—
	48"	5340-48T1	—
	54"	5340-54T1	5340-54-7
	60"	5340-60T1	—
	72"	5340-72T1	—
	84"	5340-84T1	—



Incandescent All-Round Anti-Glare Light, Straight Pole

Anti-glare lens focuses light beam to reduce glare in driver's eyes. Straight Pole with locking-collar is adaptable to most 90° competitive bases. 9W wedge-base lamp is commonly available in auto, marine, and convenience stores.

Series	Use with Light Base
5320	910R2, 901V2, 910T2, 2520‡, 911339‡, 911370‡

‡When locking collar is removed.

Description	Pole Length	OEM Part #	Part #
2-Pin Locking-Collar Pole	20"	5320-20T1	—
	42"	5320-42T1	—
	48"	5320-48T1	—
	54"	5320-54T1	—
	54", Black	5320-54TB1	—
	60"	5320-60T1	—
	60", Black	5320-60TB1	—
	72"	5320-72T1	—



5320

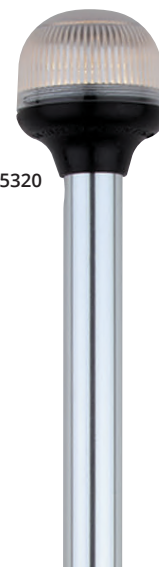

Incandescent All-Round Anti-Glare Light, Angled Pole

Angled (12°) pole model features either a locking-collar or a standard Attwood 2-pin pole. Poles are constructed of 3/4" diameter aluminum. Lens threads off for easy lamp replacement. Includes commonly available 9W wedge-base lamp.

Series	Use with Light Base
5300, 5310	910R2, 901V2, 910T2, 2520‡, 911339‡, 911370‡

‡When locking collar is removed.

Description	Pole Length	OEM Part #	Part #
2-Pin Locking-Collar Pole	66"	5310-66T1	—
2-Pin Standard Pole	60"	5300-60-1	—
	72"	5300-72-1	—



5310, 5300

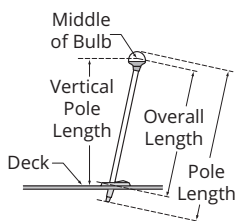

Incandescent All-Round Frosted Globe Light

Provides 2-mile, 360° illumination for boats up to 65.6 ft. (20 m). Includes 9W wedge-base lamp.

Series	Use with Light Base
5100, 5110	910R2, 901V2, 910T2, 2520‡, 911339‡, 911370‡

‡When locking collar is removed.

Description	Pole Length	OEM Part #	Part #
2-Pin Locking-Collar Pole	24"	—	5110-24-7
	30"	—	5110-30-7
	36"	—	5110-36-7
	42"	—	5110-42-7
	48"	—	5110-48-7
	54"	—	5110-54-7
2-Pin Standard Pole	24"	5100-24-1	—
	36"	5100-36-1	—
	48"	5100-48-1	—
	54"	5100-54-1	—



Incandescent Telescoping Pole Light

Stores easily in less space than a conventional All-Around light and can be removed quickly from any Attwood pole light base. Aluminum pole telescopes from 26" to 42". Provides 2-mile, 360° illumination for boats up to 65.6 ft. (20 m). Includes 12W lamp.

Description	Pole Length	OEM Part #	Part #
Telescoping Pole Lights	26" - 42"	—	5610-48-7



Incandescent Stowaway Light with Plug-In Base

Swivel cover on base protects the socket when light is stowed. Base extends just 3" below deck. 4" L x 1-5/8" W x 1-3/8" dia. Provides 2-mile, 360° illumination for boats up to 65.6 ft. (20 m). Includes 911339 base and 9W wedge-base lamp. Three countersunk holes for #10 fasteners.

Description	Pole Length	OEM Part #	Part #
2-Pin Standard Pole with 911339 Base	24"	—	7100A7
	30"	—	7100B7
	36"	—	7100C7



All-Round Plug-In Bases

LIGHTARMOR™ Plug-In Bases

LightArmor™ Plug-In Light Bases are designed for premium performance, durability, and attractive styling that helps them stand out. This combination of intelligent design and engineering make them worthy of the Light Armor name.

They're a Sure Fit

The threaded design feature fits perfectly with the threaded locking collar now offered across the entire line of Attwood pole lights. This unique system ensures a tight and secure fit that prevents annoying rattling while underway or trailering.

Plenty of Style Choices

The upgraded styling and appearance comes in three popular shapes and a range of material finishes, including Composite, 316 Stainless Steel, and Stainless Steel Overmold, that are sure to appeal to everyone.

Other Key Features

- Unique cover design ensures that the cover stays in place
- Low-profile prevents water from pooling on the top surface
- 2-and 3-pin options



910V Series: Rectangle

LIGHTARMOR™
PLUG-IN BASES

910R Series: Round

910T Series: Teardrop

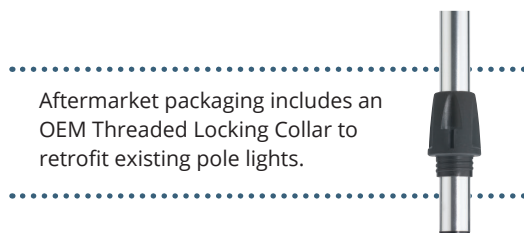

Aftermarket packaging includes an OEM Threaded Locking Collar to retrofit existing pole lights.

LIGHTARMOR™ 910V Series Rectangle Base

Classic rectangle design is available in Black Composite and 316 Stainless Steel.

Light Base	Use with Pole Light	
910V2	LED Anti-Glare: 5530 and 5540 Series Bi-Color: NV6LC1, 5092, and 5091 Series Frosted Globe: 5110 Series Anti-Glare: 5310, 5320, 5330, and 5340 Series	
910V3	Bi-Color: NV6LC2 and 5095 Series	
Description	OEM Part #	Part #
2-Pin Light Base		
Black Composite Cover	910V2PB-1	910V2PB-7
316 Stainless Steel	910V2SS-1	910V2SS-7
3-Pin Light Base		
Black Composite Cover	910V3PB-1	910V3PB-7
316 Stainless Steel	910V3SS-1	910V3SS-7



910V2PB

910V2SS

LIGHTARMOR™ 910R Series Round Base

Round base is available in Black Composite, and 306 Stainless Steel Overmold (black and white).

Light Base	Use with Pole Light	
910R2	LED Anti-Glare: 5530 and 5540 Series Bi-Color: NV6LC1, 5092, and 5091 Series Frosted Globe: 5110 Series Anti-Glare: 5310, 5320, 5330, and 5340 Series	
910R3	Bi-Color: NV6LC2 and 5095 Series	
Description	OEM Part #	Part #
2-Pin Light Base		
Black Composite Cover	910R2PB-1	910R2PB-7
Overmold 306 Stainless Steel Black Cover	910R2PSB-1	910R2PSB-7
Overmold 306 Stainless Steel White Cover	910R2PSW-1	—
3-Pin Light Base		
Black Composite Cover	910R3PB-1	910R3PB-7
Overmold 306 Stainless Steel Black Cover	910R3PSB-1	910R3PSB-7



LIGHTARMOR™ 910T Series Teardrop Base

Elegant teardrop base is available in Black Composite, and 306 Stainless Steel Overmold (black and white).

Light Base	Use with Pole Light	
910T2	LED Anti-Glare: 5530 and 5540 Series Bi-Color: NV6LC1, 5092, and 5091 Series Frosted Globe: 5110 Series Anti-Glare: 5310, 5320, 5330, and 5340 Series	
910T3	Bi-Color: NV6LC2 and 5095 Series	
Description	OEM Part #	Part #
2-Pin Light Base		
Black Composite Cover	910T2PB-1	910T2PB-7
Overmold 306 Stainless Steel Black Cover	910T2PSB-1	910T2PSB-7
Overmold 306 Stainless Steel White Cover	910T2PSW-1	—
3-Pin Light Base		
Black Composite Cover	910T3PB-1	910T3PB-7
Overmold 306 Stainless Steel Black Cover	910T3PSB-1	910T3PSB-7
Overmold 306 Stainless Steel White Cover	910T3PSW-1	—



Square 2-Pin Base for Straight Poles

2-pin base for traditional-style Attwood pole lights, constructed of nylon. Hinged cover snaps closed to keep dirt and water out when light is stowed. Socket is keyed to prevent incorrect insertion of pole lights. Four countersunk holes for installation of fasteners. Includes 7-1/2" hard wire leads for connection to 12V DC power supply.

- Dimensions: 2-1/4" x 1-3/4". 1-1/4" diameter installation hole size.
- Contacts are nickel-plated to resist corrosion and multi-crimped for durability.
- Wire leads are tinned for corrosion-resistance.

Light Base	Use with Pole Light	
911370	LED Anti-Glare: 5570 Series Bi-Color: 5091 Series Frosted Globe: 5100 Series Anti-Glare: 5300 Series	
Description	OEM Part #	Part #
2-Pin, Black	911370-1	—



Vertical Mount with Pin Contacts for Straight Poles

Can be mounted on flat windshield frame and includes a "V" adapter for mounting on angled windshield frame. Also for use as a transom mount in open utility boats. Black plastic with hinged lid that closes to keep dirt and water out when stowed away. Two holes for #8 screws. Includes 7-1/2" hard wire leads for connection to 12V DC power supply.

- Dimensions: 4-1/4" x 1-1/2" x 1-1/8"
- Contacts are nickel-plated to resist corrosion and multi-crimped for durability.
- Wire leads are tinned for corrosion-resistance.

Light Base	Use with Pole Light
911370	LED Anti-Glare: 5570 Series Bi-Color: 5091 Series Frosted Globe: 5100 Series Anti-Glare: 5300 Series
Description	OEM Part # Part #
2-Pin, Black	911490-1 —



Oval 2-Pin Base for Angled Pole

This resilient 2-pin base is used for angled pole lights with locking-collars. Ideal for installation in close quarters, such as narrow gunwales or deck areas. Narrow base has a soft rubber cover with a gasket to seal the socket.

- Contacts are nickel-plated to resist corrosion and multi-crimped for durability.
- Wire leads are tinned for corrosion-resistance.

Light Base	Use with Pole Light
91022	Frosted Globe: 5110 Series Anti-Glare: 5310, 5330 and 5340 Series LED Anti-Glare: 5530 and 5540 Series Bi-Color: 5091 Series
Description	OEM Part # Part #
2-Pin, Black	91022-1 91022-7

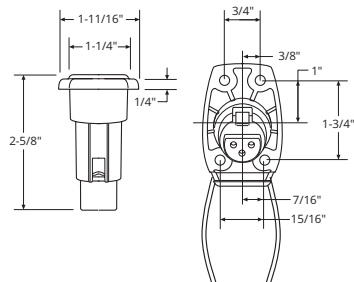

Rectangle 2-Pin Base for 12° Angled Pole

Swivel cover protects the socket when light is stowed away. Socket is keyed to prevent incorrect insertion of pole light. Three countersunk holes for installation fasteners. Includes 7-1/2" hard wire leads for connection to 12V DC power supply.

- Dimensions: 4" x 1-5/8". 1-3/8" dia. installation hole size.
- Contacts are nickel-plated to resist corrosion and multi-crimped for durability.
- Wire leads are tinned for corrosion-resistance.

Light Base	Use with Pole Light
911339	Frosted Globe: 5110 Series Anti-Glare: 5300 Series Bi-Color: 5091 Series
Description	OEM Part # Part #
2-Pin, ZAMAK	911339-1 911339-7



All-Round Fold-Down Lights

All Attwood All-Round Fold-Down Navigation Lights include a durable, easy-to-use, easy-to-install, LightArmor™ Fold-Down Base.

- Robust design provides easy, single-handed cam-lock operation
- Built to last in harsh marine environments

LIGHTARMOR™ LED All-Round Fold Down Navigation Lights

- USCG certified
- Provides 2-mile, 360°, illumination for boats up to 39.4 ft. (12m)
- Operating range = 10.5V DC - 14.4V DC
- LightArmor™ All-Round navigation light engine
- 30% lighter light engine than earlier Attwood all-round lights
- Exclusive condensation management increases visibility
- Exclusive anti-glare engine preserves night vision
- Shock-, corrosion- and water-proof electronics
- Durable, anodized aluminum pole
- Articulating head for use in all applications
- Includes new LightArmor Fold-Down Base
- Over 50,000 hour life

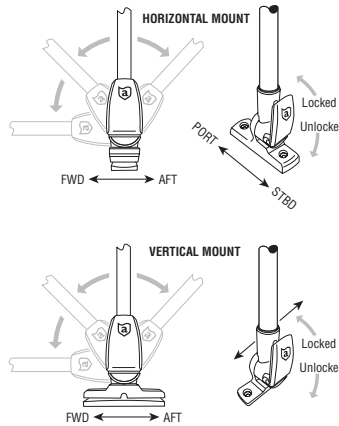
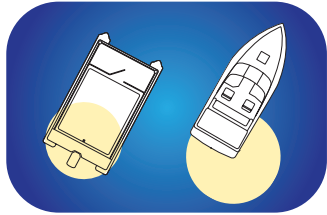

2 NM
USCG

LED Articulating Anti-Glare

Draws 20% less power than traditional all-round lights
5550 Series



Description	Pole Length	OEM Part #	Part #
LED ANTI-GLARE LIGHTS			
ZAMAK base-Horizontal Mount	12" Aluminum Pole	5550-12Z1	—
	24" Aluminum Pole	5550-24Z1	—
	30" Aluminum Pole	5550-30Z1	—
	36" Aluminum Pole	5550-36Z1	—
Stainless steel base-Horizontal Mount	12" Aluminum Pole	5550-S12-1	—
	18" Aluminum Pole	5550-S18-1	—
	24" Aluminum Pole	5550-S24-1	—
	30" Aluminum Pole	5550-S30-1	—
	36" Aluminum Pole	5550-S36-1	—
Composite base; Black-Horizontal Mount	12" Aluminum Pole	5550-P12-1	—
	20" Aluminum Pole	5550-P20-1	—
	24" Aluminum Pole	5550-P24-1	—
Composite base; Black-Horizontal Mount with Adaptor	12" Aluminum Pole	—	5557-P12A7▣
	12" Plastic; Black Pole	—	5558-P12A7▣
	20" Aluminum Pole	—	5550-PA20-7▣
Composite base; Black Vertical Mount	12" Aluminum Pole	5551-P12-1	—
Composite base; Black-Vertical Mount with Adaptor	20" Aluminum Pole	—	5551-PA20-7▣
ALL-ROUND ADAPTOR			
Rail Mount Adaptor, Black Composite		913670-1	—
Rail Mount Adaptor, Stainless Steel		913671-1	—

▣ All Aftermarket Packaged lights include Rail Mount Adaptor

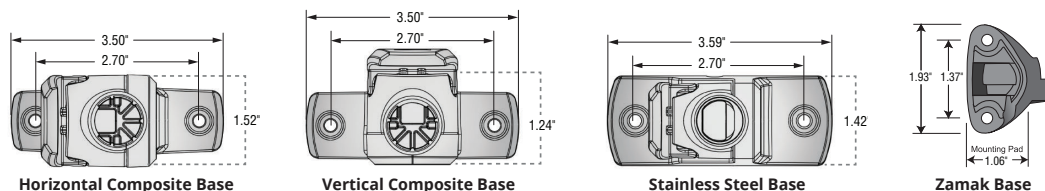

Horizontal Composite Base

Vertical Composite Base

Stainless Steel Base

Zamak Base

Incandescent All-Round Fold-Down Lights

- Provides 2-mile, 360°, illumination for boats up to 39.4 ft. (12m)
- Incandescent All-Round navigation light engine
- Shock-, corrosion-and water-proof electronics
- Durable, anodized aluminum pole
- Anti-glare lens preserves night vision
- USCG certified
- Assembled with Attwood's new LightArmor bases
- Black composite cam-lock base
- Stainless steel cam-lock base
- Zamak knob-style base

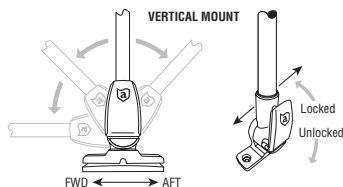
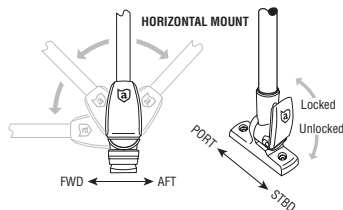
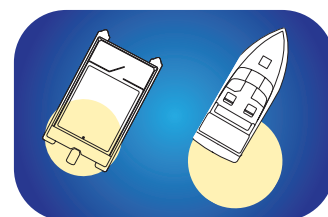

ZAMAK Base

Stainless Steel Base

Black Composite Base

Description	Pole Length	OEM Part #	Part #
ANTI-GLARE LIGHTS			
ZAMAK Base-Horizontal Mount	24" Aluminum	5350-24Z1	—
	30" Aluminum	5350-30Z1	—
	36" Aluminum	5350-36Z1	—
Composite Base; Black-Horizontal Mount with Adaptor	12" Aluminum	—	5350-PA12-7 [Ⓜ]
	12" Black Plastic	—	5358-P12-7 [Ⓜ]
	20" Aluminum	—	5350-PA20-7 [Ⓜ]
Composite Base; Black-Vertical Mount	12" Aluminum	5351-P12-1	—
ANTI-GLARE LIGHTS			
Rail Mount Adaptor, Black Composite		913670-1	—
Rail Mount Adaptor, Stainless Steel		913671-1	—

[Ⓜ] All Aftermarket Packaged lights include Rail Mount Adaptor



Articulating Anti-Glare
Include 9W wedge base lamp
5350 Series



913671



913670

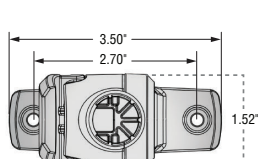

Horizontal Composite Base

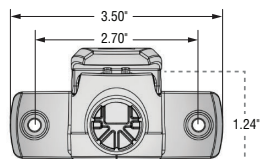

Vertical Composite Base

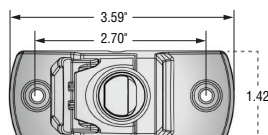

Stainless Steel Base

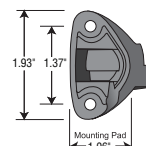

Zamak Base

All-Round Fixed Base Lights

Incandescent All-Round Fixed Base Pole Lights

Two-mile, 360° light visibility for use on boats up to 39.4 ft. (12 m). Fixed base for use on pontoons, hard tops, and radar arches. 2-1/2" long x 1" wide. Installs with (2) required #10 fasteners. Includes 9W wedge base lamp.

Description	Pole Length	OEM Part #	Part #
Frosted Globe Style	8" aluminum	—	5122-08-7



Frosted Globe

LIGHTARMOR™ LED Waketower All-Round Light

Compact size designed for installation on a wakeboard tower, radar arch, hard top, poling platform, tuna tower, or other fixed structure. Direct LED replacement for Attwood's incandescent 5940 series. For pleasure craft up to 39.4 ft (12 m).

- Two-mile, 360° visibility
- Fully sealed electronics
- Tab release

Description	OEM Part #	Part #
6" Wire Leads	5580-1	5580A7
12" Wire Leads, No Sleeve	5582-1	—
16' Wire Leads	5581-1	—
Replacement Base	5580-03	—



5580



5580-03

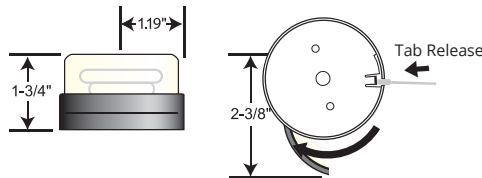

Incandescent All-Round Deck Mounted Lights

7-inch leads for connection to 12V DC power supply. Bayonet lock secures lens and cover to base and provides easy lamp replacement. Includes a 9W wedge base lamp. Installs directly to deck with two required #10 fasteners.

Raised Base

3-inch high raised base is ideal for mounting above obstructions, such as rails and hardware. Notch in rear of mounting base provides passage for wire leads.

Deck Mount

Light mounts flush, making it ideal for installation atop the tow piece on ski or wakeboard boat towers.

Description	OEM Part #	Part #
3" Raised Base, Black	5980-1	—
Deck Mount, Black	5940-1	5940-7



5980



5940

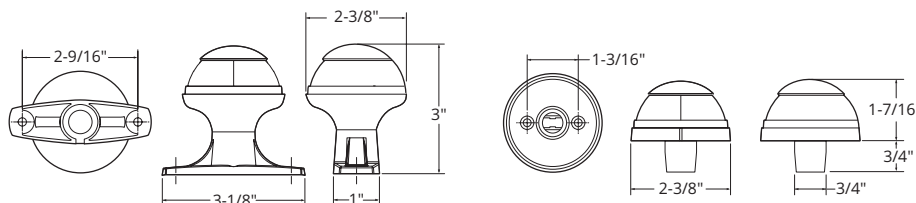

Anchor/Masthead Lights

LIGHTARMOR™ LED Anchor/Masthead Lights

Attwood is proud to introduce one of the most innovative navigational lighting products available today. Achieving 3NM of 360° visibility, while drawing a fraction of the power of traditional incandescent lights, Attwood's 3NM LightArmor™ LED Masthead/Anchor light is one of the first of its kind. Constructed of corrosion resistant composites with stainless steel accents, this product was designed for harsh coastal marine environment.

- USCG certified for boats up to 65' (20m)
- Provides 3-mile, 360° illumination
- Light Armor Anchor/Masthead navigation light engine
- Shock-, corrosion-and water-proof electronics
- Durable, anodized aluminum pole
- Includes new LightArmor Fold-Down Base
 - Cam-lock bases include integrated wire-management
 - Easy, single-handed cam-lock operation
 - Stainless steel
- Over 50,000 hour life
- 5-year warranty

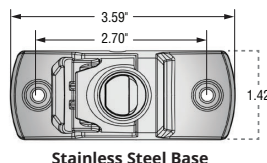

Stainless Steel Base



Description	Rated Voltage	Pole Length	OEM Part #	Part #
Stainless Steel - Horizontal Mount	12V	12" Aluminum	7812-S-1	7812-S-7
	12V	24" Aluminum	7824-S-1	—
	12V	36" Aluminum	7836-S-1	—
	12V	42" Aluminum	7842-S-1	—
ZAMAK - Horizontal Mount	12V	12" Aluminum	7812Z1	—



7812

LIGHTARMOR™
Stainless Steel Horizontal Base

Incandescent Anchor/Masthead Lights

Three-mile, 360° light visibility for use on boats up to 65.6 ft. (20 m). Assembly includes new LightArmor™ bases.

- Robust and easy to use
- Freshwater and saltwater compatible
- Simple, one-piece lens is sealed from water
- Concealed, protected wiring at the base
- Uses two festoon-style 8W lamps
- Typical installation requires (2) #10 stainless steel screws of length suitable for deck or rail material
- Will collapse and not break if accidentally hit

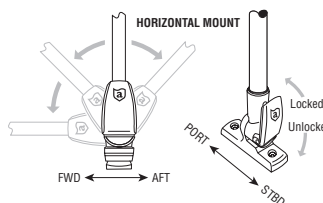

ZAMAK Base

Black Composite Base

Description	Base	Rated Voltage	Pole Length	OEM Part #	Part #
Horizontal Mounted with rail adaptor	Composite; Black	12V	12" aluminum	—	7201-P-7
		12V	20" aluminum	—	7202-P-7
Rail Mount Adaptor for Fold-Down light base	Composite; Black	—	—	913670-1	—
	Stainless Steel	—	—	913671-1	—

913671



913670



For base dimensions see page 62

Transom Lights

LED 3-Mile Transom Light

For pleasure craft up to 164 ft. (50m) in length. Creating 135 degrees of light at 3-mile of visibility. A truly unique design, Attwood's transom light includes a luxurious electropolished stainless cover that is both durable and great looking. Easy-to-install surface mount design utilizes a snap feature to eliminate exposed fasteners. 3" diameter.

- One of the thinnest lights available – 1/2" height
- Compatible with both Attwood and Perko® mounting holes

Description	OEM Part #	Part #
Stainless Steel	6556-1	6556-7

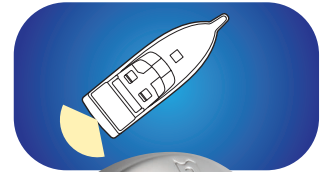

6556



LED Portable Lighting

For nighttime operation of small boats and tenders without 12V electrical systems. These lights are not intended to meet U.S. Coast Guard regulations. Not for use on boats that can exceed speeds of seven knots.

LED Portable Navigation Light Kit

Be seen and be safe with these compact and portable LED navigation lights. All new portable navigation lights are more durable, easier to use, and include Attwood's strongest mounting and pole configurations. Ideal for personal water craft, camping, and hunting. Kit includes red/green LED bow light, white LED stern light, quick-release mounts, pole, and hardware.

- Water-resistant bow and stern navigation lights
- Attwood's most durable, portable LED navigation light engines
- Sealed electronics, built to last in harsh conditions
- Sealed, shock-proof composite housing
- Shatter-proof polycarbonate lens
- 150+ hour run-time on three AAA batteries (not included)
- New telescoping and threaded poles
- New heavy-duty C-clamp and kayak pad mounting options



Description	Finish	Pole Style	Mounting Style	OEM Part #	Part #
Clamp-On	Marine Gray	Threaded	C-Clamp	—	14190-7
	Real Tree® Max-5 Camouflage	Threaded	C-Clamp	—	14191-7
	Marine Gray	Telescoping	C-Clamp	—	14194-7
	Real Tree® Max-5 Camouflage	Telescoping	C-Clamp	—	14195-7
Deck Mount	Marine Gray	Telescoping	Optional screw-down or adhesive pad	—	14192-7
	Real Tree® Max-5 Camouflage	Telescoping	Optional screw-down or adhesive pad	—	14193-7
All-Craft Navigation	Marine Gray	Threaded	C-Clamp, screw-down and adhesive pad	—	14196-7
	Real Tree® Max-5 Camouflage	Threaded	C-Clamp, screw-down and adhesive pad	—	14197-7

LED Multi-Function Sport Light

Durable, water-resistant, multi-purpose light can be used as a bright 300 fixture lumen flood light or 50 lumen red beam for improved night vision. Also has a UV mode for charging fishing lures and line. Ideal for fishing, boating, hunting, camping and more. Features four mounting options and 360° rotation. Includes an adapter for use with Attwood rod holder mount. Requires six AA batteries (not included).

Description	OEM Part #	Part #
Multi-Purpose Light, marine gray	—	14185XFS-7
Multi-Purpose Light, camouflage	—	14187XFS-7



LED Docking Lights

LED Docking Lights

- Light draws a fraction of the power while producing a brighter output. 5 watts at 12V DC each. Transmits light in a much broader pattern as opposed to a narrow beam generated by today's competitors.
- At less than 1" thick, the lights are designed to be mounted directly to the surface of the hull with only a small hole for wiring. Requires (3) #8 stainless steel Phillips Head screws (not included).
- Attwood LED technology keeps the light cool to the touch.
- Backed by a 5-year warranty, Attwood's LED docking lights are designed with the most extreme conditions in mind. Attwood uses only the highest grade stainless and aluminum components to ensure the product will be resistant to corrosion.
- To ensure the light is watertight, all electrical components are fully sealed.
- Attwood's simple one-piece cover allows for the ultimate in customization.
- 4-inch lead wires

Attwood LED Docking Light vs. Halogen Current Draw (Amps)

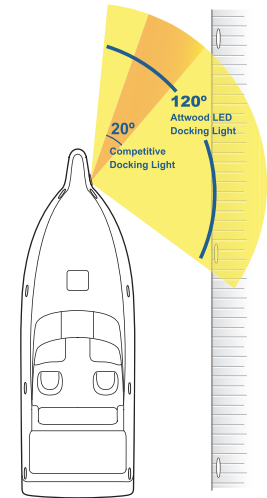
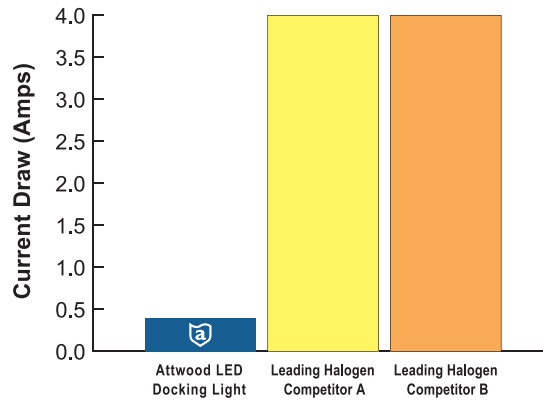

6521SS



6522SS

6523BK

Description	Dimensions	OEM	
		Part #	Part #
Stainless Steel Bezel, White LED, Pair	4-1/8" H x 8-1/8" W x 3/4" D	6521SS1	—
Stainless Steel Bezel, White LED, Pair	1.2" H x 4.5" W x 2.8" D	6522SS1	6522SS7
Black Powder Coat Bezel, White LED, Pair	1.2" H x 4.5" W x 2.8" D	6523BK1	6523BK7

LED Underwater Lights

LIGHTARMOR™ LED Underwater Lights

Introducing LightArmor™ Underwater Lights from Attwood, a new line of premium surface-mount LED lights that are engineered to be the brightest and most durable lights in the industry. Like all LightArmor™ products, they're technically advanced, built to perform in the harshest marine environments, and backed by an industry-leading 5-year warranty.

- 12V and 24V DC systems
- Intelligently engineered for strength and durability
- Exclusive Heat-Sync Cooling System with Active Overheat Protection
- Resistant to corrosion, chemicals, and UV damage
- Extreme impact-resistant lens
- 3 ft. sheathed wire
- Reverse polarity protection
- Fully-sealed waterproof electronics
- Simple installation with minimal mounting hardware
- Low-profile design
- Electro-polished 316 stainless steel cover (Optional for OEM)
- CE certified



Three popular sizes - 4", 5", 6"

Three vibrant colors - Sapphire Blue, Intense White, Tactical Green

Two performance levels - High Performance (HP), Extreme High Performance (HPX)

Note: All Light Armor Underwater lights MUST BE MOUNTED UNDER WATER LINE. Only work underwater.

Outshining the Competition.

LIGHTARMOR™ Underwater Lights are the brightest on the market.

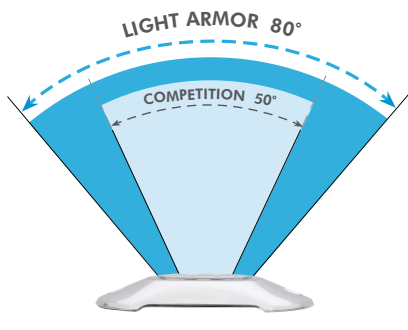

Projection Intensity vs. Competitor

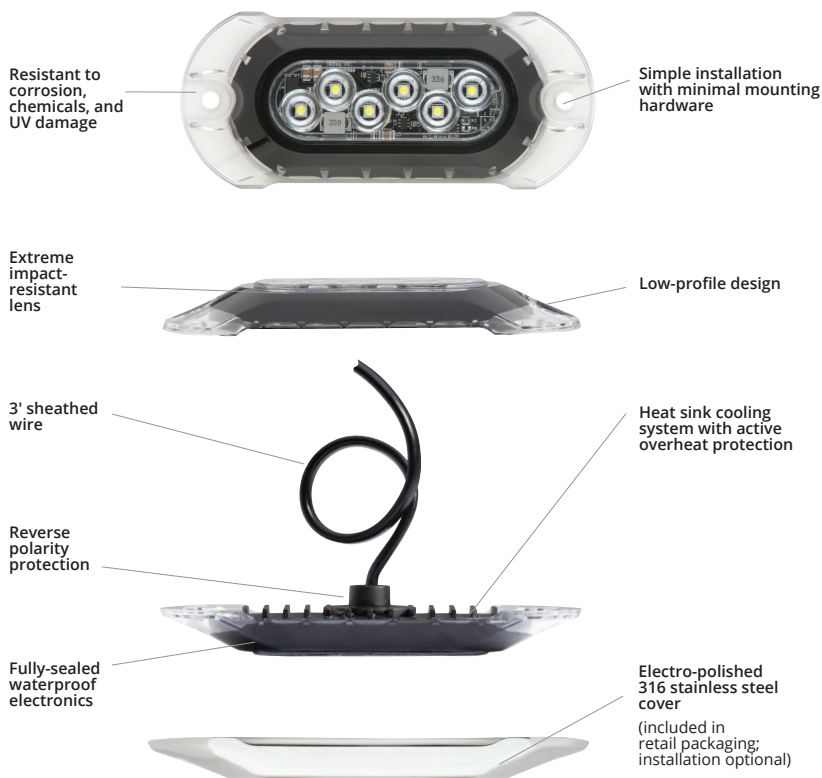

LIGHTARMOR™ LED Underwater Lights

NOTE: Bulk packaging **does not** include covers and aftermarket packaging does include covers.



Sapphire Blue
65UW03B



Tactical Green
65UW03G



Intense White
65UW03W

Description	Color	Fixture Lumens*	Current Draw at 13.6V	Current Draw at 24V	OEM Part #	Part #
High Performance (HP)						
4.0 HP - 4" length, 3 LED	Sapphire Blue	800	0.32	0.16	65UW03B-1	65UW03B-7
	Tactical Green		0.36	0.18	65UW03G-1	65UW03G-7
	Intense White		0.64	0.32	65UW03W-1	65UW03W-7
5.0 HP - 5" length, 6 LED	Sapphire Blue	1,350	0.66	0.33	65UW06B-1	65UW06B-7
	Tactical Green		0.71	0.36	65UW06G-1	65UW06G-7
	Intense White		1.26	0.63	65UW06W-1	65UW06W-7
6.0 HP - 6" length, 12 LED	Sapphire Blue	1,650	1.32	0.66	65UW12B-1	65UW12B-7
	Intense White		2.52	1.26	65UW12W-1	65UW12W-7
Extreme High Performance (HPX)						
4.0 HPX - 4" length, 3 LED	Sapphire Blue	1,350	0.64	0.32	—	66UW03B-7
5.0 HPX - 5" length, 6 LED	Sapphire Blue	2,750	1.30	0.65	66UW06B-1	66UW06B-7
	Tactical Green		1.40	0.70	66UW06G-1	—
	Intense White		2.46	1.23	66UW06W-1	—
6.0 HPX - 6" length, 12 LED	Sapphire Blue	5,000	2.59	1.30	66UW12B-1	66UW12B-7
	Intense White		4.50	2.25	66UW12W-1	66UW12W-7
Optional Covers - For OEM only (Aftermarket packaged product includes 316 Stainless Steel Cover)						
4.0 HP/HPX Cover	Stainless Steel				65UW03CVSS-1	—
5.0 HP/HPX Cover	Stainless Steel				65UW06CVSS-1	—
6.0 HP/HPX Cover	Stainless Steel				65UW12CVSS-1	—

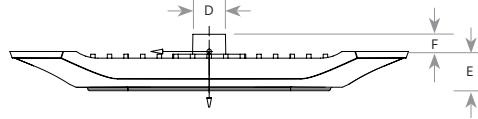
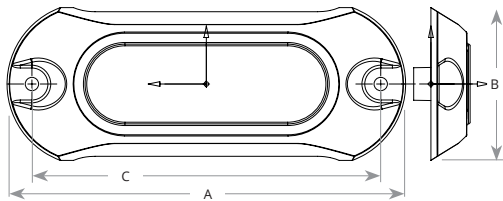

Dimensions

Model	Length (A)	Width (B)	Distance Between Mounting Holes (C)	Diameter of Wiring Hold (D)	Installed Product Height (E)	Wire Colar Depth (F)
4.0 HP	4.00"	2.15"	3.25"	.56"	.56"	.30"
4.0 HPX	4.00"	2.15"	3.25"	.56"	.56"	.30"
5.0 HP	5.00"	2.15"	4.25"	.56"	.56"	.30"
5.0 HPX	5.00"	2.15"	4.25"	.56"	.56"	.30"
6.0 HP	6.00"	2.35"	5.25"	.56"	.56"	.30"
6.0 HPX	6.00"	2.35"	5.25"	.56"	.56"	.30"

LED Underwater Lights, 3-Inch Series

Lights are 3/4" wide and are perfect for surface mounting on rails, transoms, and swim platforms. These LED lights exceed the output of comparable halogen lights, while using 20% of the power. Lights stay cool to the touch and eliminate the burn hazard that halogen lighting can present. Fully potted electronics and stainless steel housing allow for interior and exterior mounting – even underwater! Rated for 50,000+ hours of life.

- 1.5 watts at 12V DC



6343

Description	LED Color	OEM Part #	Part #
Horizontal Mount	White	—	6343SS7
Vertical Mount	White	6344SS1	—

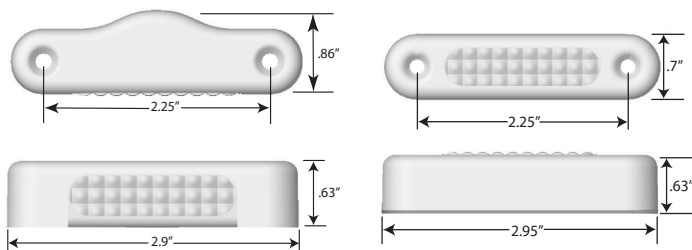

LED Utility Lights

LED Round Interior / Exterior Lights

These LED lights exceed the output of comparable halogen lights while using 20% of the power. Lights stay cool to the touch and eliminate the burn hazard that halogen lighting can present. Fully potted electronics and stainless steel housing allow for interior and exterior mounting. Rated for 50,000+ hours of life. Additional LED colors and bezel finishes are available upon request. For 12V DC systems

- Easy installation with minimal intrusion

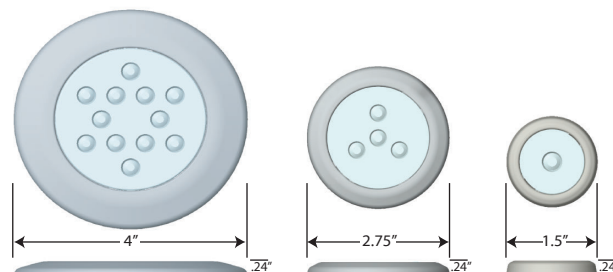

6340SS



6341SS



6320B



6320W



6342

Description	LED Color	OEM Part #	Part #
4" Round Interior Light, 3 Watts @ 12V DC			
Stainless Steel Bezel	White	6340SS1	6340SS7
	Warm White + Red	6348SS1	—
2.75" Round Interior Light, 1.8 Watts @ 12V DC			
Stainless Steel Bezel White	White	—	6341SS7
	Warm White	6346SS1	—
Black Plastic Bezel	White	6320B1	—
	Amber	6321B1	—
White Plastic Bezel	White	6320W1	6320W7
	Blue	6323W1	6323W7
1.5" Round Courtesy Light, 1.1 Watts @ 12V DC			
Stainless Steel Bezel	White	6342SS1	6342SS7

LED Mini Courtesy Lights

Attwood's 1" Mini LED Courtesy Lights offer excellent performance in an affordable package. Designed to be installed with just a hole saw, the Mini's rubber grommet eliminates fasteners and allows for quick and easy installation. Comes with fully sealed electronics; performs in almost any interior or exterior application.

- Compact
- Water-and shock-resistant
- 50,000 hours of life

Description	Color	OEM Part #	Part #
Rubber Grommet, Black	White	6317-1	—
	Blue	6319-1	—



6317

LED Micro Lights

Industry leading light output in an extremely compact package. With electropolished stainless steel covers and fully sealed electronics. Attwood Micro Lights perform through the harshest conditions. Can be used in rod storage boxes without risk of water damage, under hardtops, or even mounted to rails.

- .66 watts at 12V DC

Description	Color	OEM Part #	Part #
Stainless Steel Bezel, Vertical Mount	White	6350W1	6350W7
	Blue	6350B1	6350B7
Stainless Steel Bezel, Horizontal Mount	White	6351W1	—
	Blue	6351B1	—
	Green	6351G1	—



6350



6351

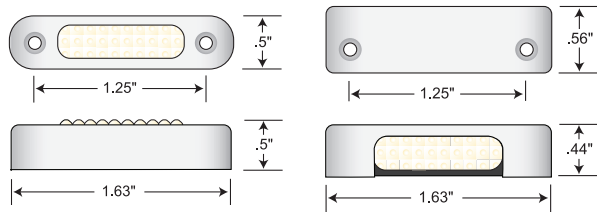

LED Utility Lights

These versatile, surface-mount LED Utility Lights put bright light where you need it.

- Water-resistant
- 12V DC
- Less than 1 Amp draw

Description	OEM Part #	Part #
4", 6 white LED's	—	6355W7
6", 12 white LED's	—	6354W7
8", 18 white LED's	—	6353W7



6353W7



6354W7

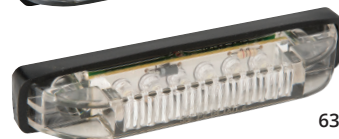

6355W7

Lighting Accessories & Replacements

QUASAR Quick-Connect Snap-On Bases

This ingenious base makes Quasar sidelights even easier to install and maintain! Base is 1/4" high, designed for contoured decks. Base attaches to the deck with screws, then the Quasar light simply snaps on or off.

Description	Description	OEM Part #	Part #
Snap-on base, 1/4" high	Black	3300-1	—

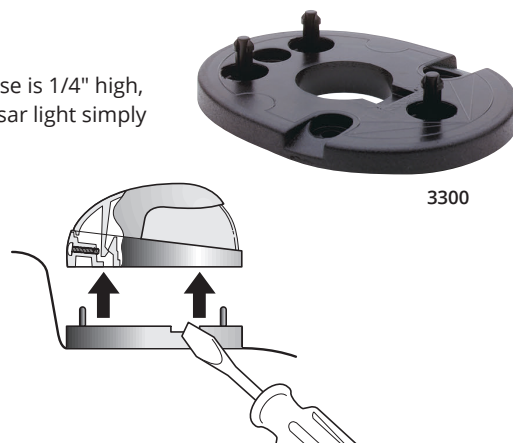
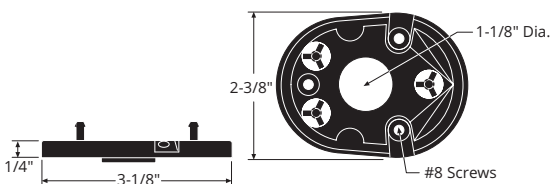

3300

Pole Light Storage Clips

New design holds larger (3/4") diameter anti-glare pole lights. Resilient plastic clip holds standard 3/4" diameter poles. Ideal for storing and protecting plug-in pole lights when mounted in engine wells or lockers. Installs with one #8 fastener.

Dimensions	Description	OEM Part #	Part #
2" L x 1-1/2" H	Black	7571-1	7571L7



7571

FUEL

Portable Fuel Tanks



76

Attwood fuel tanks are tested to meet EPA, CARB, and ABYC requirements. The tanks have industry leading fuel flow performance and are designed and manufactured for safety and durability.

Portable Fuel Components



81

Tank to engine solutions providing uncompromising reliability and durability. These unique components set the standard in performance, safety, and value.

Fuel Tanks & Hose Fittings



82

Attwood offers a variety of fuel tank and hose fittings that are suitable for use with leaded, unleaded, ethanol blended and alcohol-blended fuels.

Integrated Fuel Components



87

Attwood's integrated fuel components are designed for an industry-leading combination of safety, ease of use, and refueling performance. Engineered and tested for optimal vessel performance.

Fuel Accessories



93

Reliable portable and integrated fuel system solutions for your fuel needs.

Portable Fuel Components, International



96

International portable fuel components are manufactured using advanced technology, producing high-quality products.

Integrated Fuel Components, International



98

International integrated fuel components are uniquely designed and engineered for extreme strength for your boat's fuel system.



Portable Fuel Systems Overview

EPA Certified / CARB Approved

Your Comprehensive Tank-to-Engine Solution

As a result of EPA regulations to reduce evaporative emissions, portable fuel systems are now manufactured to prevent fuel vapor from escaping into the atmosphere. These EPA compliant systems are sealed and unable to vent as in the past, causing pressure build up in the tank that rarely occurred prior to these regulations.

In addition, each component within the system adds potential restriction to fuel flow. As fuel restriction levels rise, engine performance is affected. In some cases, complete failure can occur.

Attwood's EPA Certified Portable Fuel System components are designed specifically to handle the problems caused by pressure build-up and fuel restriction inherent in today's closed EPA compliant systems.

With Attwood's systems, your engine will perform properly and valuable fuel will stay in the tank where it belongs. Attwood's systems were developed, with leading engine manufacturers, to ensure optimum, reliable performance on the water. That's the performance you'd expect from the industry leader in marine fuel systems and accessories.

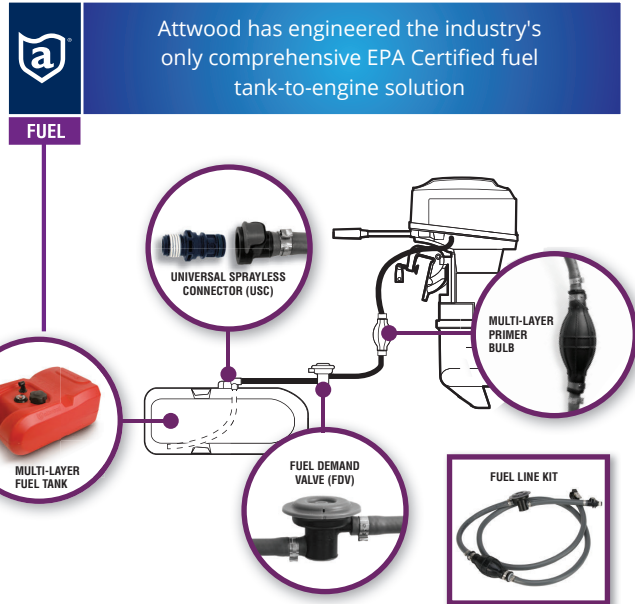

EPA Certified Portable Fuel Tanks

Attwood fuel tanks are tested to meet EPA and CARB requirements and ABYC standards for portable marine tanks. The tanks have industry leading fuel flow performance and are designed and manufactured for safety and durability in harsh marine conditions.

- Proven automotive-grade multi-layer construction withstands the pressure build-up associated with closed systems
- Engineered for harsh conditions, temperature extremes and abuse
- Injection molded interfaces eliminate leaks
- Automatic vacuum valve in cap eliminates the need for manual vent
- Compatible with 1/4" NPT fuel fittings
- Built-in 5% ullage for fuel expansion

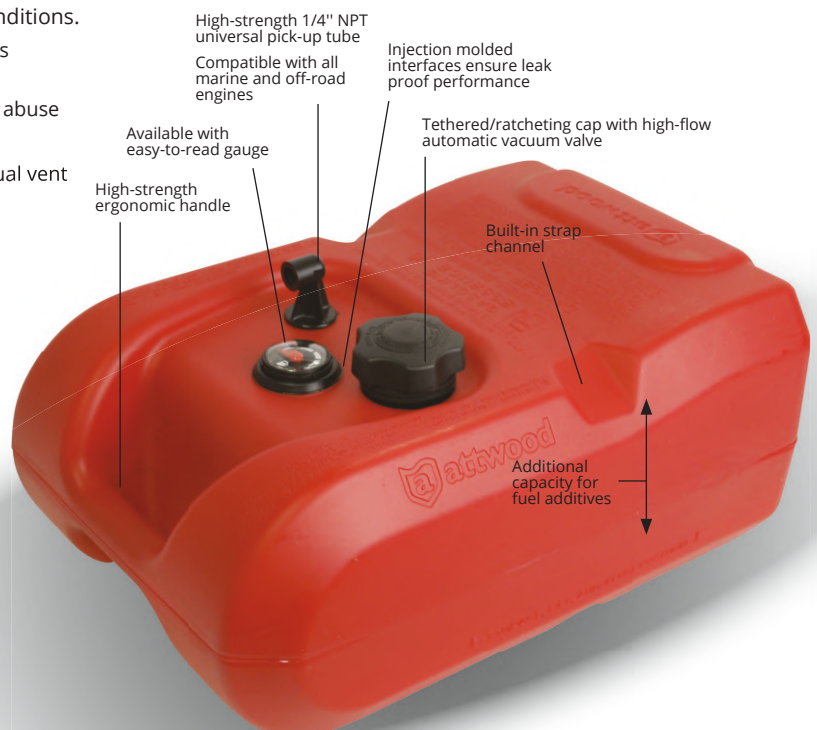
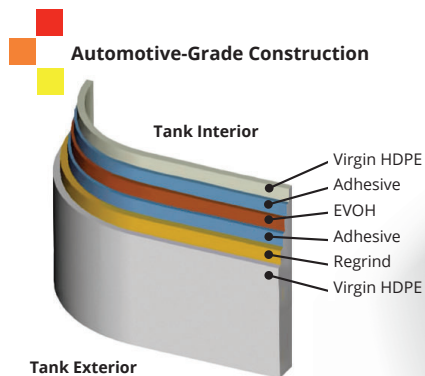

Portable Fuel Tanks

EPA Certified / CARB Approved

EPA Certified multi-layer tank with industry leading fuel flow performance. Designed around the EPA and California Air Resources Board (CARB) regulations. Features an ergonomic design, an optional gauge and a tethered self sealing cap with audible click.

- Automatic Vacuum Valve ensures proper fuel flow and eliminates the need for manual vent and operator adjustment
- Low-permeation tank virtually eliminates fuel evaporation and fuel loss
- Compatible with 1/4" NPT fuel fittings
- Ethanol and alcohol compatible
- EPA & CARB Certified



3-Gallon Fuel Tanks

EPA/CARB COMPLIANT 3-gallon fuel tank is perfect for use with small outboards.

Description	Dimensions			Part #
	Length	Width	Height	
3-gallon, without gauge	16.6"	11.45"	7.3"	8803LP2
3-gallon, with gauge	16.6"	11.45"	7.3"	8803LPG2
3-gallon, without gauge, single-pack	16.6"	11.45"	7.3"	8803LP2S
3-gallon, with gauge, single-pack	16.6"	11.45"	7.3"	8803LPG2S

6-Gallon Fuel Tanks

EPA/CARB COMPLIANT 6-gallon fuel tank adapts to virtually any outboard engine.

Description	Dimensions			Part #
	Length	Width	Height	
6-gallon, without gauge	19.82"	13.50"	9.16"	8806LP2
6-gallon, with gauge	19.82"	13.50"	9.16"	8806LPG2
6-gallon, without gauge, single-pack	19.82"	13.50"	9.16"	8806LP2S
6-gallon, with gauge, single-pack	19.82"	13.50"	9.16"	8806LPG2S

12-Gallon Fuel Tanks

EPA/CARB COMPLIANT 12-gallon fuel tank is ideal for pontoon boats where more fuel capacity is needed.

Description	Dimensions			Part #
	Length	Width	Height	
12-gallon, without gauge	22.75"	14.25"	14.47"	8812LP2
12-gallon, with gauge	22.75"	14.25"	14.47"	8812LPG2
12-gallon, low-profile, without gauge*	24.00"	18.00"	11.61"	8812LLP2
12-gallon, low-profile, with gauge*	24.00"	18.00"	11.61"	8812LLPG2



Attwood fuel tank gauges are easy-to-read, accurate and durable.



8803LP



8803LPG



8806LP



8806LPG



8812LP



8812LPG



8812LLPG

Portable Fuel Components

EPA Certified / CARB Approved

Primer Bulbs

EPA Certified / CARB Approved

Attwood's multi-layer primer bulbs provide the absolute best combination of performance, reliability, safety and compliance to ensure your experience on the water is easier and safer to enjoy. Our exclusive three-layer design resists collapsing and hardening and ensures high output in temperatures ranging from 18°F to 122°F. Includes high-efficiency check valves with Viton O-rings for improved sealing. Assembled with the same components as Mercury and Quicksilver.



- Exclusive three-layer construction provides the best spring-back during priming and excellent resistance to collapse during high-flow engine operation
- Premium materials give the absolute best combination of performance and reliability:
 - No cracking/hardening over time
 - Low permeation for EPA/CARB compliance
 - Excellent priming in extreme cold and hot environments
 - Zero chance of material delamination as seen by some competitor's products
- New high-performance check valve O-rings provide 30% improved priming while keeping optimized flow during engine use (20 to 35% better than spring-loaded designs)
- EPA and CARB certified

Description	OEM Part #	Part #
3/8" I.D. Hose	—	93038LP7
5/16" I.D. Hose	—	93516LP7
1/4" I.D. Hose	—	93014LP7

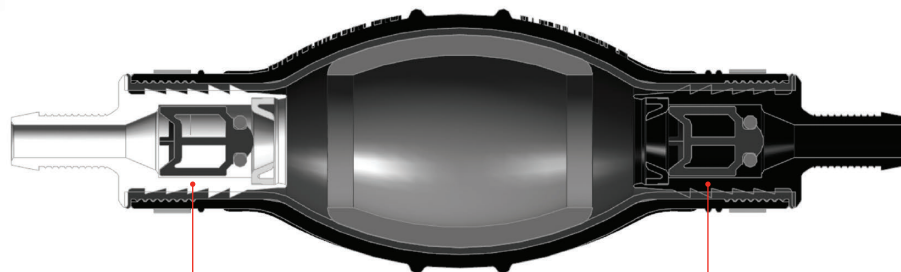
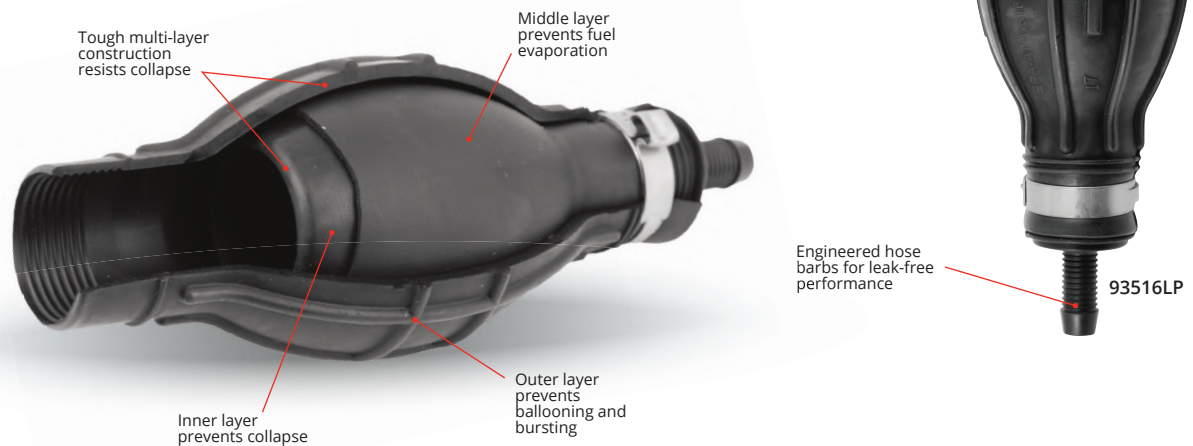

New, high-performance check valves with O-Rings provide 30% faster priming during start-up and high flow when running (20 to 35% better than spring-loaded designs)

Fuel Demand Valve EPA Certified / CARB Approved

Attwood's exclusive Fuel Demand Valve eliminates engine flooding and spillage by preventing pressurized fuel from reaching the engine. The valve ensures that fuel is supplied to the engine only when demanded during start up or engine operation. Designed in partnership with OEM engine manufacturers, Attwood's Fuel Demand Valve is compatible with all OEM engine brands.

- Prevents engine flooding and fuel spillage due to pressurized fuel
- Allows only the amount of fuel requested by the engine and prevents a pressurized "slug" of fuel from reaching engine
- Made of high-strength composite material designed to withstand the harsh marine environment
- Compatible with 3/8" and 5/16" fuel hose
- Installs between the fuel tank and the primer bulb
- Low vacuum restriction helps ensure proper engine function during startup and engine operation (less than 2kPa at 125 liters/hour)
- Built-in manual override
- Compatible with Ethanol blended fuels



Specifications

Operating Temp	Storage Temp	Operating Input Pressure	Flow Performance	Hose Size	Manual Override
-20 °C to 80 °C (-4 °F to 176 °F)	-40 °C to 80 °C (-40 °F to 176 °F)	138 kPa (20 psi) protected for 276 kPa (40 psi) psi pressure spike	125 L/H (33 GPH) at <2 kPa (10" gasoline)	8 mm - 10 mm (5/16" - 3/8")	Yes

Description	OEM Part #	Part #
In-Line Fuel Demand Valve	8M0044687	9300FDV7

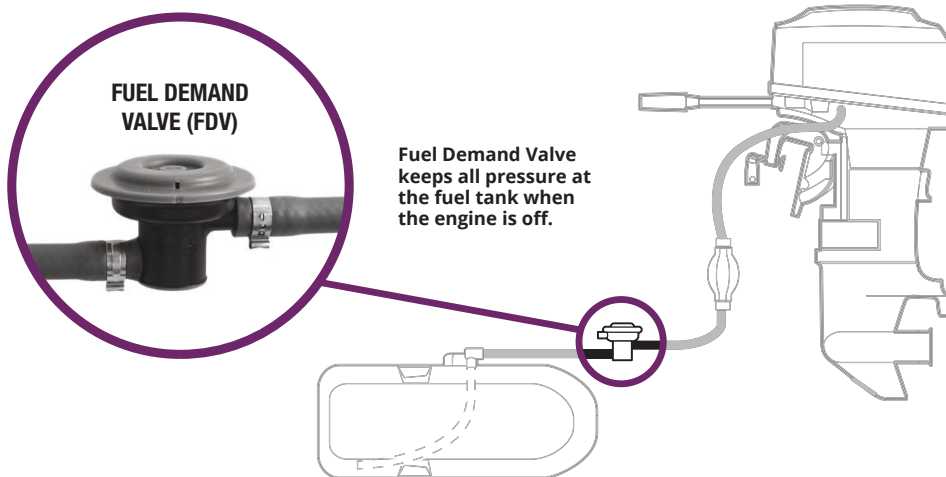

Universal Sprayless Connector (USC) EPA Certified / CARB Approved

The Universal Sprayless Connector is a safe way to eliminate the spraying of fuel when connecting and disconnecting pressurized fuel hoses during fueling or maintenance.

- Attwood's Universal Sprayless Connector replaces traditional tank fittings and eliminates spray when connecting or disconnecting fuel fittings
- High strength body engineered to withstand the harsh marine environment
- Female hose and Male hose fittings compatible with 3/8" and 5/16" fuel lines
- Male tank fitting has pre-applied fuel-grade thread sealant to prevent fuel leaks and fits all standard 1/4" NPT fittings
- Male and female connectors include check valves that automatically close upon disconnecting
- High fuel flow fitting (less than .25kPa restriction at 50 liters/hour)
- Compatible with Ethanol blended fuels
- Compatible with all OEM brand engines

Description	OEM Part #	Part #
Male and Female w/Thread Sealant	—	8838US6
Hose Female, 5/16"-3/8"	001008200	8838HF6
Tank Male, 1/4" NPT w/Thread Sealant	001008199	8838TM6
Hose Male, 5/16"-3/8"	001011094	8838HM6

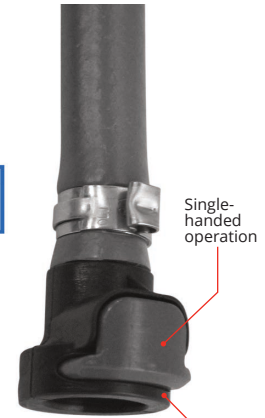

Single-handed operation



PRE-APPLIED FUEL-COMPATIBLE THREAD SEALANT

Tank fitting included with all EPA kits

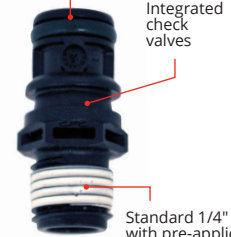

Integrated check valves
Standard 1/4" NPT with pre-applied thread sealant



8838HF6



8838TM6



8838US6



8838HM6

Fuel Line Kits EPA Certified / CARB Approved

Attwood's low-permeation Fuel Line Kits set the standard in performance, safety and value. They include Attwood's award-winning Universal Sprayless Connector (hose and tank fittings with thread sealant), multi-layer low-permeation Primer Bulb and low-permeation fuel line. Fuel Demand Valve is optional.



- Multi-Layer Primer Bulb with new High-Performance Check Valve & O-Ring: Provides 30% faster priming during start-up and 20-35% higher running flow than competitive designs
- Ethanol Resistant Fuel Line: Eliminates inner-layer delamination seen by others
- Fuel Demand Valve (if equipped): Prevents engine flooding by restricting pressurized fuel from reaching the engine
- Universal Sprayless Tank Fitting: Enables a safe, gas-free experience at every connection

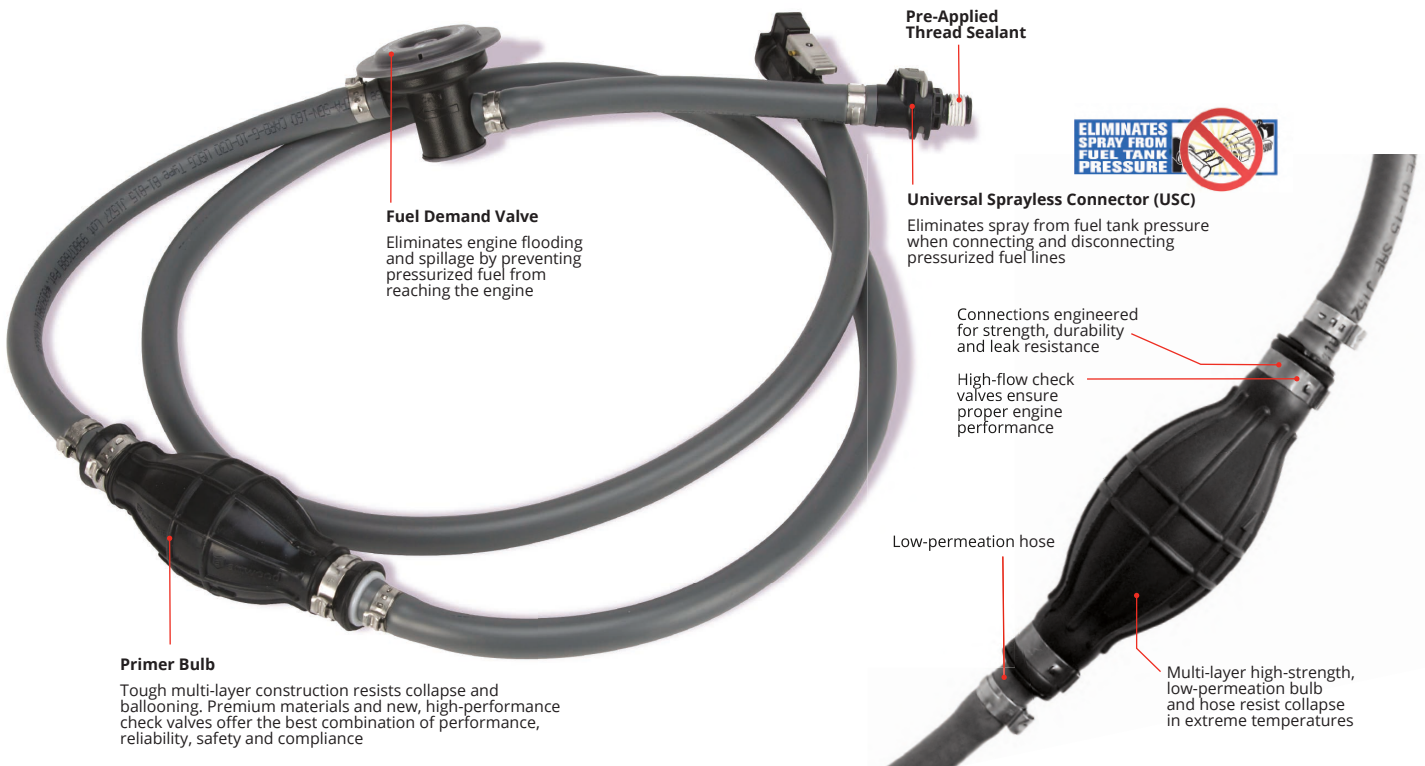

End Fitting									
Engine	Length	Diameter	Includes Tank Fitting	Includes Hose Fitting Tank End	Includes Hose Fitting Engine End	Primer Bulb	Fuel Demand Valve	Part #	
Universal Brand Engines and Tanks									
Universal	6'	5/16"	None	None	None	Multi-layer / Low-Permeation	No	951606ULP7	
Universal	6'	3/8"	8838TM6	8838HF6	None	Multi-layer / Low-Permeation	No	93806UUS7	
Universal	6'	3/8"	8838TM6	8838HF6	None	Multi-layer / Low-Permeation	Yes	93806UUSD7	
Universal	12'	3/8"	8838TM6	8838HF6	None	Multi-layer / Low-Permeation	No	93812UUS7	
Universal	12'	3/8"	8838TM6	8838HF6	None	Multi-layer / Low-Permeation	Yes	93812UUSD7	
Universal	6'	3/8"	None	None	None	Multi-layer / Low-Permeation	No	93806ULP7	
Universal	6'	3/8"	None	None	None	Multi-layer / Low-Permeation	Yes	93806UFDV7	
Universal	12'	3/8"	None	None	None	Multi-layer / Low-Permeation	No	93812ULP7	
Mercury Brand Engines and Tanks									
Mercury	6'	3/8"	8838TM6	8838HF6	8896LP6	Multi-layer / Low-Permeation	No	93806MUS7	
Mercury	6'	3/8"	8838TM6	8838HF6	8896LP6	Multi-layer / Low-Permeation	Yes	93806MUSD7	
Mercury Pre-1998	6'	3/8"	8838TM6	8838HF6	8893-6	Multi-layer / Low-Permeation	No	93806AUS7	
Johnson Brand Engines and Tanks									
Johnson / Evinrude	6'	3/8"	8838TM6	8838HF6	8889LP6	Multi-layer / Low-Permeation	No	93806EUS7	
Johnson / Evinrude	6'	3/8"	8838TM6	8838HF6	8889LP6	Multi-layer / Low-Permeation	Yes	93806EUSD7	
Johnson / Evinrude	6'	3/8"	None	8889LP6	8889LP6	Multi-layer / Low-Permeation	No	93806ELP7	
Yamaha Brand Engines and Tanks									
Yamaha	6'	3/8"	None	8896LP6	8896LP6	Multi-layer / Low-Permeation	No	93806YLP7	
Yamaha	6'	3/8"	8838TM6	8838HF6	8896LP6	Multi-layer / Low-Permeation	No	93806YUS7	
Honda Brand Engines and Tanks									
Honda	6'	3/8"	8838TM6	8838HF6	8900-6	Multi-layer / Low-Permeation	No	93806HUS7	

Fuel Tank & Hose Fittings

Atwood fuel tank fittings and hose fittings are suitable for use with leaded, unleaded, ethanol blended and alcohol-blended fuels. Unless otherwise specified, threaded fittings have 1/4" male NPT threads; barbed fittings fit 3/8" I.D. hose. Clamps are not included. Use thread sealant on all threads.



Fitting	Description	Material Construction	Mates to	Notes	Part #
Mercury/Mariner					
1/4" NPT Thread	Tank Male	Brass	8890LP6	Mercury Tank Fitting	8873-6
3/8" Barb	Hose Female	Acetal	8873-6	Mercury Tank Fitting	8890LP6
3/8" Barb	Hose Female	Acetal		Mercury Engine End	8896LP6
1/4" NPT Thread	Twist-lock Tank Female	Nylon	14532-6	w/90° Elbow, 2-Piece	8882-6
1/4" NPT Thread	Twist-lock Tank Female	Die-cast Zinc	14532-6	w/90° Elbow, 1-Piece	14530-6
3/8" Barb	Twist-lock Hose Male	Die-cast Zinc	8882-6, 14530-6		14532-6
Johnson/Envinrude/OMC					
1/4" NPT Thread	Tank Male	Brass	8889LP6, 88FHE516-6		8883-6
5/16" Barb	Hose Female	Acetal	8883-6	Tank or Engine End	88FHE516-6
3/8" Barb	Hose Female	Acetal	8883-6	Tank or Engine End	8889LP6
Yamaha					
1/4" NPT Thread	Tank Male	Brass	8896LP6, 88FHY516-6		8897-6
5/16" Barb	Hose Female	Acetal	8897-6	Tank or Engine End	88FHY516-6
3/8" Barb	Hose Female	Acetal	8897-6	Tank or Engine End	8896LP6
Honda					
1/4" NPT Thread	Tank Male	Chrome-plated Brass	8902-6	90HP+ (Large Bore)	8901-6
3/8" Barb	Hose Female	Chrome-plated Brass	8901-6	90HP+ (Large Bore)	8902-6
3/8" Barb	Hose Female	Acetal		Engine End	8900-6
Chrysler					
1/4" NPT Thread	Tank Male	Chrome-plated Brass	8884-6		14509-6
3/8" Barb	Hose Female	Chrome-plated Brass	14509-6		8884-6
Suzuki					
1/4" NPT Thread	Tank Male	Chrome-plated Brass	88FTS014-6	Under 75HP (Small Bore)	14509-6
3/8" Barb	Hose Female	Chrome-plated Brass	14509-6	Under 75HP (Small Bore)	88FTS014-6
Universal					
1/4" NPT x 1/4" NPTF	90° Elbow	Brass			8887-6
1/4" NPT x 5/16" Barb	Male Thread, Hose Barb	Brass			88FBM101-6
1/4" NPT x 3/8" Barb	Male Thread, Hose Barb	Brass			14540-6
3/8" NPT x 3/8" Barb	Male Thread, Hose Barb	Aluminum			88FBMA102-6
1/4" NPT x 3/8" Barb	Male Thread, Anti-Siphon Valve	Aluminum			88FAS014-6
3/8" NPT x 3/8" Barb	Male Thread, Anti-Siphon Valve	Aluminum			88FAS038-6
3/8" Hose Mender	In-line Fuel Splice Kit	Brass		Includes (2) Stainless Steel Hose Clamps	11822-6
5/16" Hose Mender	In-line Fuel Splice Kit	Brass		Includes (2) Stainless Steel Hose Clamps	11823-6
1/4" Hose Mender	In-line Fuel Splice Kit	Brass		Includes (2) Stainless Steel Hose Clamps	11824-6

Fuel Tank Shut Off Valve

Description	OEM Part #	Part #
Brass: 1/4" NPT x 1/4" NPTF	—	88FV200-6



88FV200



Mercury



8838US6

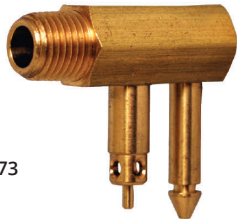

8873



8890LP



8896LP

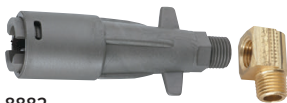

8882



14530

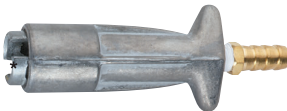

14534



14532

Johnson

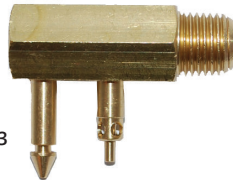

8883



88FHE516

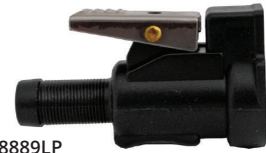

8889LP

Yamaha

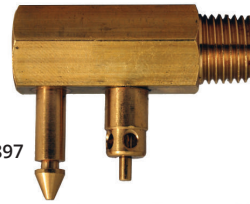

8897

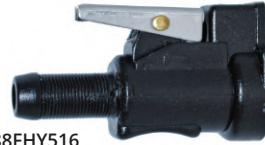

88FHY516

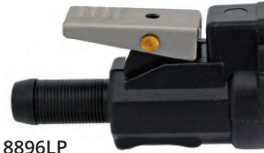

8896LP

Honda



8901

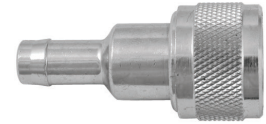

8902



8900

Chrysler



14509



8884

Suzuki



14509



88FTS014

Universal



8887



88FBM101



14540



88FBMA102



88FAS014



88FAS038



11822



11823

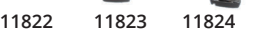

11824

Always use thread sealant when assembling threaded fittings.

VAPORTEC

Integrated Fuel Systems Overview

EPA Certified / CARB Approved

Carbon Canister Fuel Systems

The VaporTec fuel pressure management system ensures that a boat's fuel system constantly maintains proper vapor pressure in all situations. This eliminates any unintended excess pressure which can seriously damage a boat or engine.

Carbon canister systems utilize an engineered charcoal canister to reduce hydrocarbons entering the atmosphere. Other

components of a carbon canister system are designed to ensure the tank fills to the proper level every time without spit-back or well-back. All Attwood carbon canister systems are designed to ensure liquid fuel or water does not reach the canister and are compatible with Jerry Can and marine nozzle refueling.

Direct Fill Carbon Canister Fuel System

- Single 1 psi overpressure relief safety valve built into the caps
- Automatic nozzle shutoff 4-10 gpm
- Anti-backout feature prevents accidental removal
- Reduced number of system components
- Direct Fill system is well-suited for applications such as pontoon "transom" designs

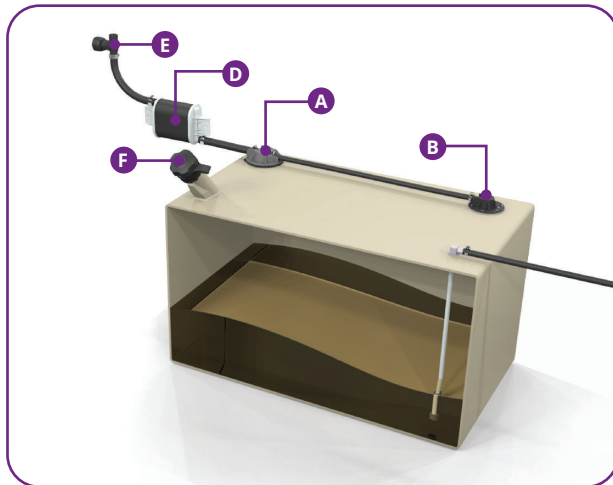

- A** Fill Limit Vent Valve
- B** Grade Valve
- C** Inlet Control Valve
- D** Carbon Canister

Remote Fill Carbon Canister Fuel System

- Dual 1 psi overpressure relief safety valves built into the deck fill caps
- Automatic nozzle shutoff 4-18 gpm

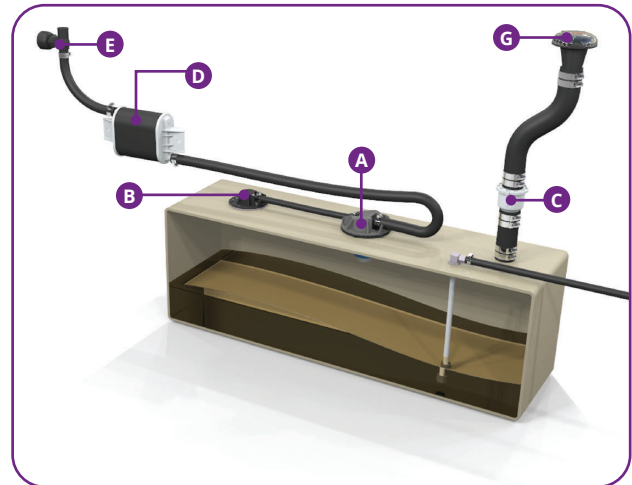

- E** P-Trap
- F** Direct Fill Unit
- G** Deck Fill Unit

Pressure Relief Fuel Systems

The VaporTec fuel pressure management system ensures that a boat's fuel system constantly maintains proper vapor pressure in all situations. This eliminates any unintended excess pressure which can seriously damage a boat or engine.

Pressure relief systems are designed with automatic diurnal emission control and overpressure relief safety valves built into the cap of the fill. The overpressure relief safety valves are

engineered to release pressure above 1 psi. The high-flow vacuum valves allow fresh air to enter the fuel tank to replace the fuel being consumed by the engine. Other components of a pressure relief system are designed to ensure the tank fills to the proper level every time without spit-back or well-back. All Attwood pressure relief systems are designed to ensure water does not enter the fuel tank and are compatible with Jerry Can and marine nozzle refueling.

Direct Fill Pressure Relief Fuel System

- Dual 1 psi diurnal emission control and overpressure relief safety valves built into the cap
- Dual high-flow vacuum valves ensure maximum make-up air flow with minimum vacuum restriction
- Automatic nozzle shutoff 4-10 gpm
- Anti-backout feature prevents accidental removal
- Reduced number of system components
- Direct Fill system is well-suited for applications such as pontoon "transom" designs

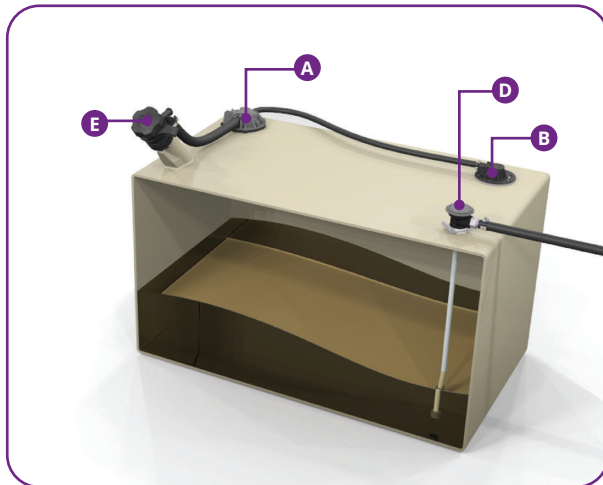

- A** Fill Limit Vent Valve
- B** Grade Valve
- C** Inlet Control Valve

Remote Fill Pressure Relief Fuel System

- Dual 1 psi diurnal emission control and overpressure relief safety valves built into the cap
- Triple high-flow vacuum valves ensure maximum make-up air flow (compatible with high HP applications)
- Automatic nozzle shutoff 4-18 gpm

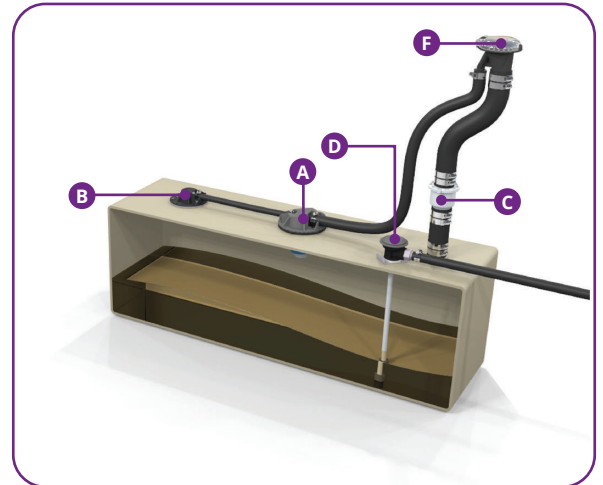



- D** Fuel Demand Valve
- E** Direct Fill Unit (Includes Inlet Control Valve)
- F** Deck Fill Unit

Diurinal Fuel System Components

EPA Certified / CARB Approved



		Carbon Canister Direct Fill	Carbon Canister Remote Fill	Pressure Relief Direct Fill	Pressure Relief Remote Fill
Carbon Canister Deck Fills			See Page 87		
Carbon Canister Direct Fill		See Page 88			
Pressure Relief Deck Fills					See Page 90
Pressure Relief Direct Fill				See Page 91	
Inlet Control Valve			See Page 92		See Page 92
Fill Limit Vent Valve		See Page 92	See Page 92	See Page 92	See Page 92
Grade Valve		See Page 92	See Page 92	See Page 92	See Page 92
Carbon Canister		See Page 89	See Page 89		
Integrated Fuel Demand Valve				See Page 90	See Page 90
P-Trap		See Page 88	See Page 88		

Fuel Systems Components

EPA Certified

Deck Fills for Carbon Canister Systems

EPA Certified

- Essential component of VaporTec and SecureStop
- Dual 1 psi overpressure relief safety valves built into the cap
- Automatic nozzle shutoff 4-18 gpm
- Hinged audible click cap meets EPA requirements
- Meets CARB 13 CCR 2235 and ISO 13331 nozzle mating and retention standards
- Designed and tested to prevent water from entering the fuel system
- Compatible with Ethanol blended fuels
- Fits 1-1/2" fill hose



Y1 Flat cap

Scalloped cap

Description	Body	Cap Material	Cap Design	OEM Part #	Part #
Deck Fill for Carbon Canister	Straight	Black Plastic	Scalloped	99DFCCSB1	99DFCCSB1S
		White Plastic	Scalloped	99DFCCSW1	—
		Chrome	Scalloped	99DFCCSZ1	99DFCCSZ1S
		Stainless Steel	Scalloped	99DFCCSS1	99DFCCS1S
		Stainless Steel	Y1 Flat	99DFCCSSY1-1	—
	Angled	Black Plastic	Scalloped	99DFCCAB1	99DFCCAB1S
		White Plastic	Scalloped	99DFCCAW1	—
		Chrome	Scalloped	99DFCCAZ1	99DFCCAZ1S
		Stainless Steel	Scalloped	99DFCCAS1	99DFCCAS1S
		Stainless Steel	Y1 Flat	99DFCCASY1-1	—



99DFCCSSY1-1



99DFCCAB1



99DFCCAW1

Low Profile Deck Fills for Carbon Canister Systems

EPA Certified

- Essential component of VaporTec and SecureStop
- Stainless steel construction
- Exclusive overpressure relief valve that is protected by a waterproof screen to eliminate the possibility of water entering the system
- 4-18 gpm refueling when used in an Attwood fuel system
- Flip-up tethered cap for ease of use
- Red dots indicate visual closure for EPA standards
- ISO 10088 and CE compliant
- Compatible with Ethanol blended fuels
- Fits 1-1/2" fill hose

Description	Body	OEM Part #	Part #
Low Profile Deck Fill for Carbon Canister	Straight	99DFCCLPSS1	—
	Angled	99DFCCLPAS1	—



99DFCCLPSS1



99DFCCLPAS1

Direct Fill for Carbon Canister Systems EPA Certified

- Essential component of VaporTec and SecureStop
- Single 1 psi overpressure relief safety valve built into cap
- Anti-backout feature prevents accidental removal
- Automatic nozzle shutoff 4-10 gpm
- Reduced number of components in the system
- Includes ratcheting tethered cap
- Compatible with Attwood's carbon canister architecture
- Meets CARB 13 CCR 2235 and ISO 13331 nozzle mating and retention standards
- Compatible with Ethanol blended fuels
- Fits 1-1/2" fill hose

Description	OEM Part #	Part #
Carbon Canister Direct Fill	99TDF100-1	—



90° P-Trap Fuel Tank Vents

These vents help prevent water from entering the fuel tank, yet allow air to vent freely, during normal sea conditions and washdowns. This eliminates the need for an anti-siphon loop in the vent hose. For 5/8" I.D. hose. Meets ABYC standard. The arrows in this cross-section show the baffled route that water would have to travel in order to reach the fuel vent hose. Compatible with Ethanol blended fuels.

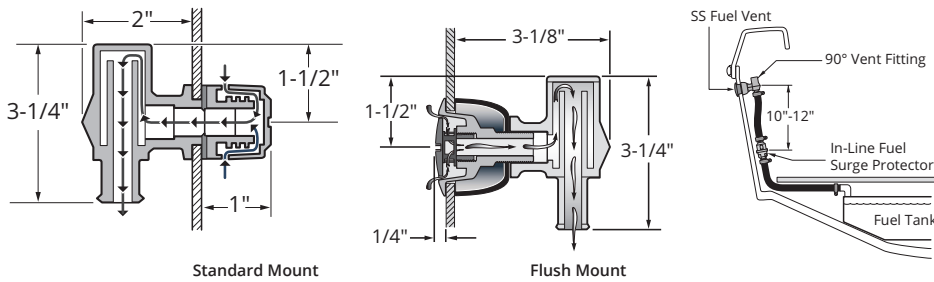

Description	Maximum Hull Thickness	Installation Hole Size	Style	OEM Part #	Part #
Standard Mount - 5/8" I.D. Hose	9/16"	3/4"	Black with black vent head	1670-1	1670-3
			Black with stainless steel trim cover	66419-1	66419-3
Replacement covers for Standard Mount	—	—	For 1670	911526-1	—
			For 66419	911528-1	—
Flush Mount - 5/8" I.D. Hose	1"	1-3/8"	Black with stainless steel vent head	1674-1	1674-6
Replacement Spacer for Flush Mount	1/4" - 1/2"	—	For 1674	911507-1	—
	1/2" - 3/4"	—	For 1674	911508-1	—

Carbon Canisters

EPA Certified / CARB Approved

- Fits 5/8" vent hose
- Can be mounted in any orientation using brackets provided
- Compatible with Ethanol blended fuels
- Low permeation shell reduces overall system emissions
- Carbon Canister for Engine Compartment models feature a pre-installed composite heat-shield for easy installation

Description	EPA Rating		CARB Rating		L x W x H	OEM Part #	Part #
	Trailerable Vessel Capacity	Non-Trailerable Vessel Capacity	Trailerable Vessel Capacity	Non-Trailerable Vessel Capacity			
Sub Compact							
Brackets OEM Installed	28 Gal.	44 Gal.	22.4 Gal.	44 Gal.	11.6" x 5.04" x 4.01"	99CC035-1	—
Carbon Canister for Engine Compartment	28 Gal.	44 Gal.	22.4 Gal.	44 Gal.	11.68" x 4.08" x 5.68"	99CC035HSA1	—
Compact							
Brackets OEM Installed	70 Gal.	110 Gal.	56 Gal.	110 Gal.	Refer to Horizontal/Vertical	99CC045-1	99CC045-1S
Brackets Pre-installed Horizontal Orientation	70 Gal.	110 Gal.	56 Gal.	110 Gal.	11.6" x 5.04" x 4.01"	99CC045H1	—
Brackets Pre-installed Vertical Orientation	70 Gal.	110 Gal.	56 Gal.	110 Gal.	10.48" x 3.05" x 5.50"	99CC045V1	—
Carbon Canister for Engine Compartment	70 Gal.	110 Gal.	56 Gal.	110 Gal.	11.68" x 4.08" x 5.68"	99CC045HSA1	—
Standard							
Brackets OEM Installed	220 Gal.	350 Gal.	176 Gal.	350 Gal.	Refer to Horizontal/Vertical	99CC085-1	99CC085-1S
Brackets Pre-installed Horizontal Orientation	220 Gal.	350 Gal.	176 Gal.	350 Gal.	17.22" x 5.04" x 4.01"	99CC085H1	—
Carbon Canister for Engine Compartment	220 Gal.	350 Gal.	176 Gal.	350 Gal.	17.74" x 4.08" x 5.68"	99CC085HSA1	99CC085HSA1S
Large Vessel							
Brackets OEM Installed	420 Gal.	660 Gal.	*N/A	*N/A	Refer to Horizontal/Vertical	99CC150-1	99CC150-1S

* CARB allows use of 2 canisters assembled in series to match/exceed needed capacity. Contact Attwood Customer Service for more information.



Deck Fills for Pressure Relief Systems

EPA Certified / CARB Approved

- Essential component of VaporTec and SecureStop
- Dual 1 psi diurnal emission control overpressure relief safety valves
- Triple high-flow vacuum valves ensure maximum make-up air flow with minimum vacuum restriction
- Designed and tested to prevent water from entering the fuel system
- Automatic nozzle shutoff 4–18 gpm
- Hinged audible click cap meets EPA requirements
- Meets CARB 13 CCR 2235 and ISO 13331 nozzle mating and retention standards
- Designed and tested to prevent water from entering the fuel system
- Compatible with Ethanol blended fuels
- Fits 1-1/2" fill hose and 5/8" vent hose



Y1 Flat cap



Scalloped cap



99DFPVSZ1



99DFPVASY1-1

Description	Body	Cap Material	Cap Design	OEM Part #	Part #
Deckfill for Pressure Relief System	Straight	Black Plastic	Scalloped	99DFPVSZ1	99DFPVSZ1
		Chrome	Scalloped	99DFPVSZ1	—
		Stainless Steel	Scalloped	99DFPVSZ1	99DFPVSZ1
		Stainless Steel	Y1 Flat	99DFPVSZ1-1	—
	Angled	Black Plastic	Scalloped	99DFPVSZ1	99DFPVSZ1
		Chrome	Scalloped	99DFPVSZ1	—
		Stainless Steel	Scalloped	99DFPVSZ1	99DFPVSZ1
		Stainless Steel	Y1 Flat	99DFPVSZ1-1	—

Fuel Demand Valve

The integrated fuel demand valve, used in conjunction with integrated fuel systems eliminates pressurized fuel from reaching fuel distribution lines and your engine and ensures that fuel is provided to the engine on demand rather than as a result of pressure in the tank. Additional features include:

- Compatible with Ethanol blended fuels
- Eliminates the need for rigid fuel distribution lines in pressure relief systems (per ABYC H-24.15.9)

Specifications

Operating Temp	Storage Temp	Operating Input Pressure	Flow Performance	Manual Override
-20° C to 80° C (-4° F to 176° F)	-40° C to 80° C (-40° F to 176° F)	138 kPa (20 psi) protected for 276 kPa (40 psi) psi pressure spike	200 L/H (53 GPH) at <2 kPa*	Yes

*Flow performance of 99IFDV00-1 with 1/2" Pick up tube and 99DVB02-1 Barb. Other factors such as fuel lift height, anti-siphon valve, fuel hose diameter and length and fuel filter will effect overall flow performance to engine.

Description	OEM Part #	Part #
Integrated Fuel Demand Valve (IFDV)	99IFDV00-1	—
Base for Aluminum Tank	99DVA02-1	—
Pick-Up Tube Barb with O-Ring 3/8"	99DVB01-1	—
Pick-Up Tube Barb with O-Ring 1/2"	99DVB02-1	—
IFDV Installation Clip	99DVC01-1	—
IFDV Plug Cap with Seal	99DVP03-1	—
Heat Shield	99IFDVHS1	—
Single Flange Base for Plastic Tank	99DVP05-1	—



99IFDV00

Direct Fill for Pressure Relief Systems EPA Certified / CARB Approved

- Essential component of VaporTec and SecureStop
- Dual high-flow vacuum valves ensure maximum make-up air flow with minimum vacuum restriction
- Dual 1 psi diurnal emission control and overpressure relief safety valves
- Anti-backout feature prevents accidental removal
- Automatic nozzle shutoff 4-10 gpm
- Reduced number of components in the system
- Includes ratcheting tethered cap
- Performs automatic shut-off function when used with an Attwood system
- EPA and CARB certified
- Meets CARB 13 CCR 2235 and ISO 13331 nozzle mating and retention standards
- Compatible with Ethanol blended fuels
- Fits 1-1/2" fill hose and 5/8" vent hose

Description	OEM Part #	Part #
Pressure Relief Direct Fill	99TDFPV100-1	—
Replacement Cap	99TDFPV110-1	—

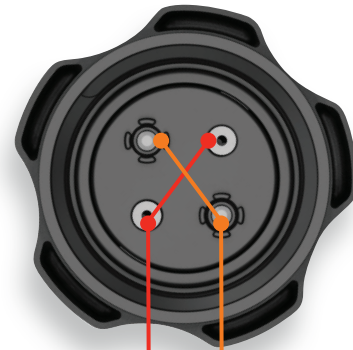

Dual 1 psi diurnal emission control and overpressure relief safety valves

Dual high-flow vacuum valves ensure maximum make-up air flow



Exclusive nozzle retention feature

Ratcheting tether cap

Low-profile vent input from tank

Low profile neck reduces interference from engine cowl

Anti-back out feature

High-strength composite body

Built-in ICV

Inlet Control Valve

EPA Certified

- Essential component of VaporTec and SecureStop
- Built-in overpressure relief compatibility
- Guaranteed 18 gallons per minute fuel flow during filling
- Compatible with 1-1/2" fill hose
- Compatible with Ethanol blended fuels
- Can be oriented between 0°–90° in line with fuel flow

Description	OEM Part #	Part #
Inlet Control Valve	99ICV000-1	—
ICV Heat Shield	99ICV000HS2	—



99ICV000

Fill Limit Vent Valves

- Essential component of VaporTec and SecureStop
- Sets the full level of fuel in the tank
- Prevents liquid fuel from reaching the carbon canister or vent system during vessel operation, trailering and storage
- Compatible with Ethanol blended fuels and plastic and aluminum tanks
- Passes all USCG CFR 33 and ABYC H-24 fire test requirements and CARB and EPA requirements
- Integrated high-performance gasket included
- Assembly Guide aligns the FLVV and gasket with tank for faster installation

Description	Shut-off Height	OEM Part #	Part #
Fill Limit Vent Valve with GRV Communication	0.8"	99FLB080-1	—
	1.00"	99FLB100-1	—
	1.40"	99FLB140-1	—
	1.70"	99FLB170-1	—
	2.30"	99FLB230-1	—
Fill Limit Vent Valve without GRV Communication	3.30"	99FLB330-1	—
	1.40"	99FLA140-1	—
	1.70"	99FLA170-1	—
	2.30"	99FLA230-1	—
	3.30"	99FLA330-1	—



99FLB230

Grade Valve

- Essential component of VaporTec and SecureStop
- When used in conjunction with a fill limit vent valve, allows proper venting when the fuel tank is in unusual angles
- Prevents liquid fuel reaching the carbon canister and vent system during vessel operation, trailering and storage
- Integrated impact protection feature
- Compatible with Ethanol blended fuels
- Passes all USCG CFR 33 and ABYC H-24 fire test requirements

Description	OEM Part #	Part #
Grade Valve	99GVP000-1	—
Grade Valve Tank Gasket	99GVG000-1	—



99GVG000

Accessories

For Portable and Integrated Fuel Systems



12822

Motor Well Boot

Motor well boot provides organized, covered pass-thru for control cables, wires, or fuel lines. Split side allows for installation without disconnecting controls. Includes tie for secure fit. Black rubber, UV-resistant construction with polypropylene attachment gasket ring.

Description	OEM Part #	Part #
For 4"-diameter opening	—	12820-5



11526

Fuel Tank Strap Sets

1"-wide white nylon web strap with zinc-plated carbon steel snap and quick-release buckle. Includes metal foot-man securing loops and screws.

Description	OEM Part #	Part #
48" long for 3-6 gallon tanks	—	11526-3
72" long for 12-gallon tanks	—	11512-3



14582

14580

Filter Funnel

Fine mesh screen filters out most foreign matter. Lightweight floating polyethylene plastic.

Description	OEM Part #	Part #
Short rigid, with handle	14582-1	—
Long flexible, with handle	14580-1	—



88TC06

Portable Fuel Tank Cap with Tether EPA Certified

High-flow valve exceeds OEM engine fuel flow requirements. Ratchets to ensure proper seal. For 0-350 HP engines. Compatible with 8803LP/8806LP/8812LP/8812LLP Series portable fuel tanks.

Description	OEM Part #	Part #
Standard 2-1/4" Neck	—	88TC06-7

SpillBuster™

Eliminate messy and potentially dangerous spills with this versatile spout that easily attaches to your oil and fluid bottles. On/off valve controls liquid flow. SpillBuster fits 1-quart, 1-gallon, and most 5-quart bottles. Removable cap seals shut.

Description	OEM Part #	Part #
SpillBuster spout	—	14584D1



14584D1

Fuel/Water Separator Assembly & Filter

With Double Seal. Universal 3/8" (.85cm) ports.

Universal Fuel/Water Separator (11840)

- Fits all 2 cycle engines. 10 Micron Filter and bracket included.
- Replaces Mercury 35-60494A4. Includes 2 brass plugs.

Fuel/Water Separator (11841)

- 10 Micron Replacement for: Mercury 35-60494-1, Aqua Power 6031, GLM 24940, Sierra 18-78250, SMI 15494, Valmar 52113, Marpac 7-0872

Description	OEM Part #	Part #
Universal Fuel/Water Separator	—	11840-7
Fuel/Water Separator	—	11841-4



Outboard Fuel Filter

Disposable high-flow in-line fuel filters work with most outboard motors. Protects carbureted engines by trapping pollutants. Clear body allows visual inspection. High strength, impact resistant, and shatter resistant construction. Best to replace during winterize or spring start-up for optimum results.

Description	OEM Part #	Part #
Outboard Fuel Filter for 3/8" lines	—	12562-6
Universal In-Line Fuel Filter (1/4", 5/16", 3/8")	—	11820-7



12562



11820

Fuel/Oil Mixing Bottle

Allows the addition of the exact amount of oil required for a 2 cycle engine. Oil level marks are in gallons and litres. Determines ratios for 100:1, 50:1, 24:1 and 10:1 mixes. Wide mouth, quart size bottle.

Description	OEM Part #	Part #
Oil to Gas Mixing Container	—	11873-1



11873

Hydro-Stabilizer

Gives outboards and sterndrives a performance boost, improving both stability and handling. The Hydro-Stabilizer out-performs ordinary flat hydrofoils by reducing drag when the hull goes on plane. Installs on a large variety of motor styles and sizes and includes stainless steel bolts and lock nuts. Wings constructed of black molded plastic. The Hydro-Stabilizer quickly puts the boat on plane and helps pull skiers out of the hole faster. Even at lower RPMs, it keeps the boat on plane. The wings provide a smoother, more stable ride and reduces prop cavitation in turns.

Description	OEM Part #	Part #
For outboards and stern drives 50 horsepower and above	—	9400-7
For outboards under 50 horsepower	—	9401-7

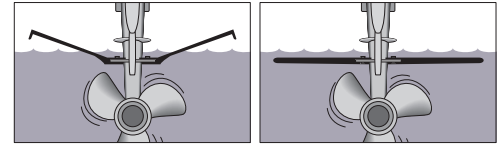

Hydro-Stabilizer

Ordinary Hydrofoil



9400



11664

Outboard Motor Safety Cable

Prevents loss of small outboard engines. Clear vinyl-coated, heavy-duty steel cable. Has a loop on one end, and includes a snap hook on the other end. 3/32" diameter, 50" long.

Description	OEM Part #	Part #
3/32" dia. x 50" long	—	11664-3



11891

Gear Lube Pump

For use with 32 oz. gear lube bottles. The pump fits any outboard or sterndrive to provide universal fit. Includes one Yamaha® adapter.

Description	OEM Part #	Part #
Gear Lube Pump	—	11891D7

Universal Motor Flushers

Quickly flushes away salt, sand, silt, and alkali to prevent clogging and corrosion. The flusher attaches easily to an ordinary garden hose. Self-adjusting clamping yoke fits most domestic or imported I/O's and outboards. Molded cups deliver fresh water from a garden hose to flush the cooling system through side intakes on the lower unit. Note: Do not use full flow from hose.

Description	OEM Part #	Part #
Round with plastic body	—	9372-2
Round with metal body	—	16205-2
Rectangular motor flusher with metal body	—	16207-2
Universal dual water feed with metal body	—	16208-7



9372

16205

16207

16208

Portable Fuel Components—International (Not for use in the U.S.)

Fuel Line Kits

For use with portable fuel tanks and popular outboard engines. Made to the highest quality standards.



Engine & Tanks	End Fitting					Primer Bulb	Fuel Demand Valve	Part #
	Length	Dia	Tank Fitting	Fits Attwood Tank Fitting	Engine Fitting			
Universal	6'	3/8"	None	N/A	None	Standard	No	93806UI7
Mercury	6'	3/8"	8890LP6	8873-6	8894LP6	Standard	No	93806MI7
Johnson / Evinrude	6'	3/8"	8889LP6	8883-6	8889LP6	Standard	No	93806EI7
Yamaha	6'	3/8"	8896LP6	8897-6	8896LP6	Standard	No	93806YI7

Primer Bulbs

For easy replacement on any portable fuel line. Alcohol resistant, suitable for use with leaded and non-leaded fuels. Double check valve for quick priming and unrestricted flow. Non-corrosive, galvanized hose clamps. Strong and durable.



Description	OEM Part #	Part #
3/8" I.D Hose—International	—	9303817
5/16" I.D Hose—International	—	9351617



Integrated Fuel Components—International (Not for use in the U.S.)

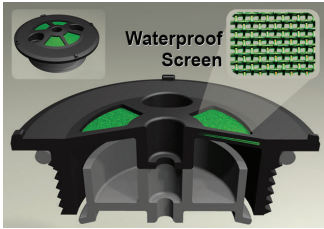

Vented Deck Fills

Attwood's plastic vented deck fills incorporate an industry first patent-pending waterproof screen that eliminates the possibility of water entering a boat's fuel system, while also allowing your boat's engine to breathe freely. These deck fills exceed the ISO 10088 standard for minimum required venting area and meet all ABYC and US Coast Guard safety standards for marine fuel systems. Attwood's unique design includes an integral tank vent with flame arrestor and anti-surge technology.



Features:

- Integrated patent-pending waterproof screen eliminates the possibility of water entering your boat's fuel system
- Attwood's unique design includes an integral tank vent with flame arrestor and anti-surge technology, preventing fuel from escaping into the environment
- Engineered body designed for extreme strength
- Choose from oval or round, straight or angled configurations
- Round caps available in plastic, chrome or stainless steel to fit virtually any application and budget
- Stainless steel beaded chain to prevent loss of round Gasoline, Diesel and Water caps
- ISO symbols for Gasoline, Diesel, Water and Waste are located on top of the cap
- Deck plate key is included with gasoline fill
- Fits standard 1-1/2" fuel fill hose and 5/8" vent hose
- Requires (4) #8 screws

Description	Material	Imprint	Cap Design	OEM Part #	Part #		
Oval Vented Deck Fills							
Straight	Black Plastic	Gasoline	Scalloped	99210GB1	—		
Angled	Black Plastic	Gasoline	Scalloped	99211GB1	—		
Round Vented Deck Fills							
Straight	Black Plastic	Gasoline	Scalloped	99200GB1	—		
	Stainless Steel	Gasoline	Scalloped	99200GS1	—		
		Diesel	Scalloped	99200DS1	—		
Chrome	Water	Scalloped	99200WS1	—			
		Gasoline	Scalloped	99200GZ1	—		
Angled	Black Plastic	Gasoline	Scalloped	99200WZ1	—		
				99201GB1	—		
	Stainless Steel	Gasoline	Scalloped	99201GS1	—		
				Diesel	Scalloped	99201DS1	—
				Water	Scalloped	99201WS1	—
Chrome	Gasoline	Scalloped	99201GZ1	—			
			Water	Scalloped	99201WZ1	—	
Round Waste Deck Fills							
Straight	Stainless Steel	Waste	Scalloped	99202WS1	—		
	Chrome-plated Zinc	Waste	Scalloped	99202WZ1	—		
Angled	Stainless Steel	Waste	Scalloped	99202AWS1	—		
				Waste	Y1	99202AWSY1-1	—

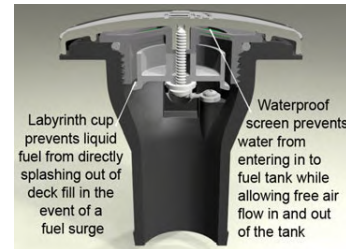

99210GB



99200GS



Y1 Flat cap



Scalloped cap

1-1/2" Deck Fills, Enhanced 316 Stainless Steel Alloy

For 1-1/2" I.D. hose. Deck fills available with imprint to specify GASOLINE, DIESEL, WATER, or WASTE. Highly-polished finish. Flush cap is slotted for separate key and features an O-ring that seals the cap watertight. Cap is attached by a stainless steel beaded chain. 3-1/4" long fill neck. Key sold separately. 66126 waste model has internal threads for pump-out nozzle. Use for vessels with built-in holding tanks. Note: Requires a bonding wire to prevent sparking when nozzle is inserted on gas and diesel models per USCG and ABYC H-24 requirements.



Specifications

Part #	Fill Neck Length	Installation Hole Size	Flange Size	Hose Size	Fastener Size
66406, 66407, 66408	3-1/4"	1-7/8"	3"	1-1/2" I.D.	#10
66126	3-1/4"	2-1/4"	3-1/2"	1-1/2" I.D.	#10

Description	OEM Part #	Part #
"Gasoline" imprint with Red Color Code (Not for use with EPA Certified systems)	66446C1	66406-5
"Water" imprint with Blue Color Code	66408C1	—
"Waste" imprint with Black Color Code	66126C1	—
Replacement key	66060-1	—
Replacement cap and chain†	—	66074-3
Replacement cap and chain only for 66126	—	66061-3



66446C



2" Deck Fills, Enhanced 316 Stainless Steel Alloy

For 2" I.D. hose. These deck fills are both imprinted and color-coded to specify either GASOLINE or DIESEL. Highly-polished finish. Flush cap is slotted for separate key and features an O-ring that seals the cap watertight. Cap is attached by a stainless steel, beaded chain. Long neck accommodates thick deck laminations. Key sold separately. Note: Requires a bonding wire to prevent sparking when nozzle is inserted on gasoline and diesel models per USCG and ABYC H-24 requirements.



Specifications

Fill Neck Length	Installation Hole Size	Flange Size	Hose Size	Fastener Size
3-1/4"	2-1/4"	3-1/2"	2" I.D.	#10

Description	OEM Part #	Part #
"Gasoline" imprint with Red Color Code (Not for use with EPA Certified systems)	66411C1	—
"Diesel" imprint with Green Color Code	66412C1	—
Replacement key	66060-1	—
Replacement cap and chain	—	66061-3



66411

† Replacement for 66406, 66407, 66408 and 66408C1 only

Fuel Vents

Enhanced 316 Stainless Steel Alloy Flush-Mount Fuel Vents

On the exterior, they have a smooth edge over the competition. Unlike some others, there is no protruding cap to cause damage — or be damaged by — hull bumps and scrapes. Cap unscrews with hex head wrench for easy cleaning of filter and pressure testing of entire fuel system. These vents now include two silicone gaskets.



Description	Hose Size	Maximum Hull Thickness	Installation Hole Size	OEM Part #	Part #
Straight Vent	5/8" I.D.	7/8"	1-3/8"	66031-1	66031-3
90° Vent	5/8" I.D.	7/8"	1-3/8"	66032-1	66032-3

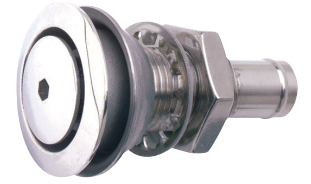

66031



66032

Enhanced 316 Stainless Steel Alloy Fuel Vents

Stainless steel vents with spark-proof screen holes.

Description	Hose Size	Maximum Hull Thickness	Installation Hole Size	OEM Part #	Part #
Straight Vent	5/8" I.D.	1/2"	7/8"	66004-1	—
90° Vent	5/8" I.D.	1/2"	7/8"	66023-1	—

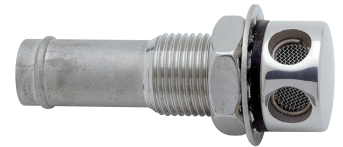

66004

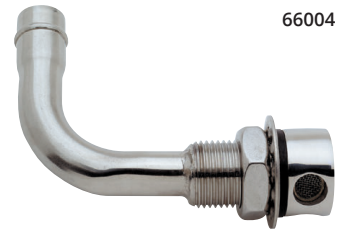

66023

Polypropylene Fuel Vents

Patented splash-resistant, corrosion-resistant polypropylene.

Description	Color	Hose Size	Maximum Hull Thickness	Installation Hole Size	OEM Part #	Part #
Straight Vent	Black	5/8" I.D.	7/8"	3/4"	1607-1	1607-3



1607

MARINE ACCESSORIES

Anchoring & Mooring Equipment



Attwood offers a wide selection of cast anchors, popular penetrating anchors, made in the U.S.A SoftSide fenders, and all the related accessories for a secure anchorage or mooring.

Marine Ropes & Cordage



Complete line of marine rope and cordage designed with the industries most recognized material and constructed for strength, flexibility, and durability.

Fishing Rod Holders & Accessories



Attwood's comprehensive selection has you covered for with all types of adjustable rod holders and interchangeable mounts.

Marine Maintenance Products



Ensure proper storage and cleaning of your vessel with Attwood maintenance products.



MARINE ACCESSORIES

Interior & Boating Accessories



123

Attwood offers a variety of boating accessories to fit all your boating needs.

Electrical Accessories



129

Attwood battery boxes are designed to better preserve your battery and protect those onboard. All battery boxes meet ABYC standard E-10 and U.S. Coast Guard specifications.

Paddlesports & Accessories



137

Designed with an optimum blend of quality construction and on-the-water performance, Attwood offers a wide selection of paddles, hardware, and storage accessories.

Trailing Parts & Accessories



144

Attwood offers a complete range of trailing equipment and accessories, for replacement and original equipment installation.



Anchoring & Mooring Equipment

Mushroom Anchors

Mushroom anchors are an economical solution for light-weight boats. The wide-area mushroom cup provides sufficient holding power in mud and weed bottoms.

- Gray cast iron
- Large, steel eye
- Available coated with aluminum-painted finish or black PVC-coated finish

Description		OEM Part #	Part #
Aluminum - Painted	8 lbs.	9941-1	—
	10 lbs.	9942-1	—
	15 lbs.	9943-1	—
Black PVC-coated	8 lbs.	9941B1	—
	10 lbs.	9942B1	—
	15 lbs.	9943B1	—



Navy Anchors

Navy anchors combine weight with flukes to dig in and hold firmly in sand and mud. The reverse action of the shank allows quick retrieval of a fouled anchor. High-quality, gray iron casting available with aluminum-painted or black PVC-coated finish.

Description		OEM Part #	Part #
Aluminum - Painted	10 lbs.	9933-1	—
	15 lbs.	9934-1	—
	20 lbs.	9935-1	—
Black PVC-coated	10 lbs.	9933B1	—
	15 lbs.	9934B1	—
	20 lbs.	9935B1	—



River Anchors

River anchors catch and hold river bottoms where mud, rocks, stumps, and brush are present. Flukes act like a grappling hook to snag rocks or other objects. Gray, cast iron with a large, steel eye and black PVC-coated or aluminum-painted finish.

Description		OEM Part #	Part #
Aluminum - Painted	8 lbs.	9944-1	—
	15 lbs.	9948-1	—
	18 lbs.	9946-1	—
Black PVC-coated	8 lbs.	9944B1	—
	12 lbs.	9945B1	—
	15 lbs.	9948B1	—
	18 lbs.	9946B1	—



Note- All OEM Packed anchors include ID label with UPC number/bar code.

Penetrating Fluke Anchors

Penetrating fluke anchors dig into mud, sand, or gravel and stow flat. Pivoting flukes rotate downward into bottom. Excellent weight-to-holding power ratio compared to cast anchors. All Attwood penetrating anchors are manufactured of hot dip galvanized steel for corrosion resistance and strength. The assembly is arc-welded steel that maintains consistent fluke-to-shank angles, ensuring quick penetration and a firm hold.

Solid Shank Penetrating Anchors

Solid shank for durability and strength.

Specifications

Part No.	A	B	C	D
9955-1	22.25"	18.38"	12.20"	10.0"
9956-1	28.18"	21.0"	14.50"	11.0"
9957-1	32.0"	24.0"	16.50"	12.0"

Size	OEM Part #	Part #
#8	9955-1	—
#13	9956-1	—
#18	9957-1	—

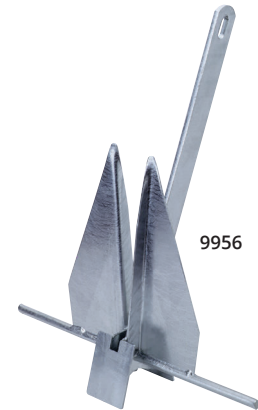
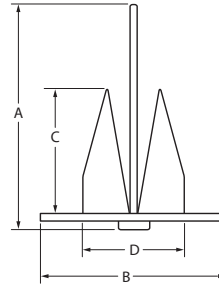

Slip-Ring Penetrating Anchors

Feature a slip-ring shank for easy retrieval of a snagged anchor.

Specifications

Part No.	A	B	C	D
9960-1	13.85"	11.50"	8.75"	8.0"
9961-1	16.35"	13.25"	8.88"	8.88"
9962-1	19.85"	14.25"	9.50"	10.0"
9963-1	21.85"	21.0"	12.0"	12.0"

Size	OEM Part #	Part #
#5	9960-1	—
#7	9961-1	—
#10	9962-1	—
#13	9963-1	—

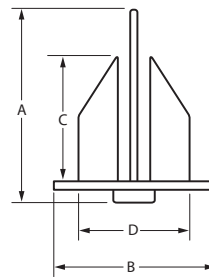

Grapnel Folding Anchors

Ideal four-fluke anchor for personal watercraft (PWC), small craft, and dinghies. Heavily galvanized, malleable iron. Folds up easily for storage. Lockable in opened or closed position.

Size	OEM Part #	Part #
3 lbs.	11964-1	—
5 lbs.	11966-1	—
7.5 lbs.	11968-1	—



Grapnel Anchor System

3.5 lb. anchor will hold your PWC, canoe, dinghy, kayak, or float tube in mud, sand, gravel, and rock. Includes 25 ft. of rope, marker buoy, giant snap hook, anchor, and durable, nylon storage case that protects your boat from scratches.

Description	OEM Part #	Part #
Grapnel Anchor System	—	11969-4



Note- All OEM Packed anchors include ID label with UPC number/bar code.

Anchor Chains and Shackle

For use on penetrating anchors. Anchor lead chain holds down anchor shanks, in order to keep anchor flat. Increases holding strength, especially in strong currents, high winds, and coastal waters. Protects line from chafing on sharp rocks. These anchor chains include a welded, oversized link on each end for easy installation and anchor attachment.

Description	Dimensions	OEM Part #	Part #
Hot dip galvanized with 2 shackles	1/4" x 4'	—	13753-7



13753-7

Lift 'n Lock Anchor Control

Easy-to-use anchor lift and pulley system supports anchors up to 20 pounds with 1/2 inch diameter line (sold separately).

Deluxe Anchor Control

- High-impact, reinforced nylon
- Stainless steel shafts
- Easy pull-up, lock, and release

Standard Anchor Control

- Economical zinc-plated, steel anchor lift
- Nylon pulley system
- Steel sheave controls anchor from any position

Description	OEM Part #	Part #
Deluxe—Anchor Lift 'n Lock	—	13702-4
Standard—Anchor Lift 'n Lock	—	13700-7



13702



13700

Anchor Lift System

This convenient system drops the anchor at the turn of a button and stores it in the anchor mount housing when not in use. Constructed of heavy-gauge steel with a durable powder coated finish and mounts on the bow or stern corners of most boats. Features self-lubricating nylon wheels. Capacity for 100 ft. of 3/16 inch line. (Anchor Line and Pulley System sold separately).

Description	OEM Part #	Part #
Anchor Lift System	—	13710-4
3/16" x 100' Braided line for lift system	—	117553-7



117553



13710

Anchor Buoy

One-piece, heavy-duty construction uses premium marine-grade vinyl for softness, pliability, and superior durability. Built-in UV inhibitors help maintain high-visibility, fluorescent orange color. MicroGuard® technology further protects from rotting, mold, and mildew.

Description	OEM Part #	Part #
Buoy, 9"	—	9350-4



9350

Anchor Ring & Rope

Assists in anchor retrieval. Designed to lift anchor systems up to 80 lbs. where 10 feet or more of anchor chain is used. Lifting capacity based on anchor buoy size. Buoy sold separately.

Description	OEM Part #	Part #
Anchor Ring with rope	—	9351-2



9351

Note- All OEM Packed Chains/Shackles include ID label with UPC number/bar code

Softside Fenders

Attwood SoftSide fenders come with a lifetime guarantee against chalking, splitting, marring, deflating, and crushing. All SoftSide fenders are made in the U.S.A. and resistant to UV and fading. Soft to the touch and easy on hulls, consumers trust the Attwood name in fenders.

SoftSide Oval Mooring Fenders

Molded from a lightweight polymeric material that is soft to the touch, and easy on hulls, and resistant to UV, chalking, splitting, and crushing. Double-molded eye ends for extra strength. Seamless one-piece construction. Oval shape and ribbed sides resist rolling against hull.

- Sold in a display carton for easy display
- Guaranteed for life against splitting or bursting

Description	Color	OEM Part #	Part #
4"-dia. x 16" L	White	—	9354D1
	Blue	—	9354BD1
5"-dia. x 22" L	White	—	9355D1
	Blue	—	9355BD1
6"-dia. x 24" L	White	—	9356D1
	Blue	—	9356BD1
8"-dia. x 28" L	White	—	9358-1
	Blue	—	9358B1



Pontoon Fender

Description	Dimensions	Mounting Pattern	OEM Part #	Part #
Pontoon Fender	8 1/2" x 16 1/2" x 10"	Strap	—	93536-1



Pontoon Fender
93536

SoftSide Dock Fenders

Molded from a lightweight polymeric material that is soft to the touch, easy on hulls, and resistant to UV, chalking, splitting, and crushing. Seamless one-piece construction.

- Sold in a PDQ display carton for easy retail display
- Guaranteed for life
- Made in the U.S.A.

Description	Dimensions		Mounting Pattern	OEM Part #	Part #
Corner Dock Fender	11-3/4" x 11-3/4" x 4-1/2"	Fits 90° angle	(4) 5/16" holes	—	93531-1
Straight-Edge Dock Fender	18" x 3-1/2" x 4-1/2"		(3) 5/16" holes	—	93532-1
Slide-On Post Dock Fender	7" diam. x 15" height	Fits up to 2-3/8" O.D. Post	(4) 5/16" holes	—	93533-1
Round Corner Dock Fender	7" diam. x 15" height	Fits 90° angle"	(6) 5/16" holes	—	93534-1
Long-Edge Dock Fender	45" x 8-1/2" x 6"		(4) 5/16" holes	—	93537-1

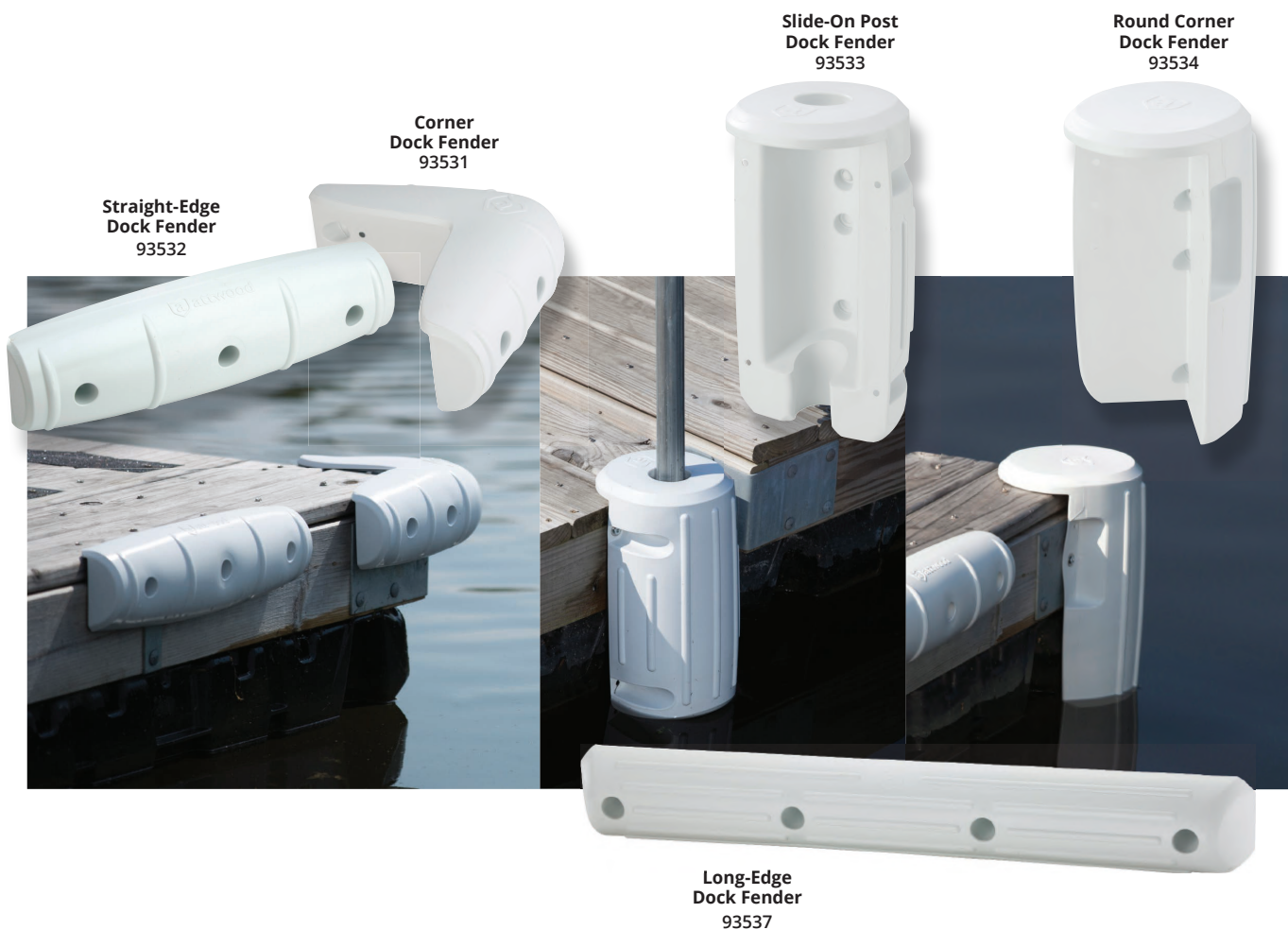

Fold-Down Dock Cleats

Ideal for small boats and watercraft. Cleats simply fold-down when not in use and flip back up when it comes time to tie off. Low-profile, fold-down design keeps cleat clear of dock traffic. Marine-grade aluminum protected with corrosion-resistant finish. Easy to install on all dock types with (2) standard 3/8 inch carriage bolts (not included).

Description	Color	OEM Part #	Part #
6" Fold-Down Cleat	White	—	12048-4
8" Fold-Down Cleat	White	—	12049-4



12048

Mooring Fender Lock Kit

Quickly and easily install or move fenders when mooring. Simply tie fender line onto key and insert key into lock. Includes (2) flush-mount stainless steel mounting plates and (2) stainless steel keys. Fasten with (2) #10 fasteners. Accepts up to 1/2 inch rope.

Description	OEM Part #	Part #
2" W x 1" H, Set	—	11575-3



11575

Boat Hook

Telescoping adjustment collar has molded ribbing – easy to grip and twist for length adjustment, even when wet. High-quality 6061-T6 aluminum tubing with marine finish and rubber vinyl grips. Hook includes non-marring polyethylene tips.

Description	OEM Part #	Part #
Extends 3-1/2' to 5-1/2'	—	11150-5
Extends 3-1/2' to 8'	—	11180-5



11180

Zig-Zag Fender Hanger

No need for knots in your fender lines. Keeps fenders in place with a simple system. Put line over rail and weave it through the zig-zag teeth.

Description	OEM Part #	Part #
Pair w/ 4' fender Lines	—	11952-7



11952

Marine Ropes & Cordage

Attwood offers a complete line of anchor and mooring products with the premium performance and quality that boaters have come to expect. Our rope products are packaged to look great, while meeting the sustainability and functional requirements demanded by our retail customers.

Rope Materials

Nylon

Nylon is recognized in the marine industry for its inherent strength, durability, and versatility. Its elasticity allows it to manage the sudden shock loads that would break ropes constructed from other materials, making it a leading choice for anchor and dock lines. Nylon is also abrasion resistant and will last much longer than natural fiber ropes.

Made from multifilament fibers that are light and heat stabilized, nylon rope is also resistant to rot, oils, gasoline, grease, marine growth, and most chemicals.

Benefits

- Strength
- Elasticity enables stretching and reduced breakage
- Resistant to UV light, rot, abrasion, mildew, oils, gasoline, and marine growth
- High wet strength

Polypropylene

Polypropylene offers high strength-to-weight performance and is available in many construction methods using monofilament fibers, which are smooth and velvety, and multifilament fibers. Both fiber types are UV stabilized to provide resistance against fading and degradation. Waterproof polypropylene ropes float and are also resistant to rot, oils, gasoline, and most chemicals.

Benefits

- Economical and versatile
- Resistant to UV light, rot, abrasion, mildew, oils, gasoline, and marine growth
- Floatable

Attwood Rope Construction Types



Twisted

- Splicable
- Economical construction
- The most common construction type for general purpose rope



Solid Braided

- Resists rotating underload
- Strong, soft, and light-weight construction
- Ideal for use in pulleys, guides, and blocks
- Resists unraveling when cut

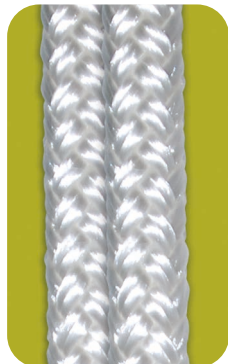

Double Braided

- Braid over braid construction (two ropes combined into one rope)
- Splicable
- Does not hockle, kink, or rotate underload
- Excellent shock absorption and elasticity



Diamond Braided

- High quality construction
- Tight interlacing of yarns
- Stiffer than solid braided rope



Hollow Braided

- Diamond braid construction with hollow center
- Easiest type construction to splice

Anchor Lines

Attwood offers anchor lines in different materials and construction types. Our twisted nylon construction is strong, hangs straight, and resists kinking. It can also be spliced, making it a favorite for the seasoned boater. Solid braided nylon lines are stable round cords that will not flatten out and will maintain a soft hand and flexibility throughout its life. We also offer a complete line of polypropylene anchor lines that are sure to meet the needs of any boater.

Premium Nylon Anchor Line

Available with Snap Hook or Thimble

Description	Thickness	Length	Color	OEM Part #	Part #
Twisted nylon line with hook	3/8"	50 ft.	White	—	11707-7
Twisted nylon line with thimble	3/8"	100 ft.	White	—	11734-1
		150 ft.	White	—	11708-1
		200 ft.	White	—	11716-1
		100 ft.	White	—	11709-1



11707



11709

Solid Braided MFP Anchor Line

Available with Spring Hook or Thimble

Description	Thickness	Length	Color	OEM Part #	Part #
MFP line with spring hook	3/8"	50 ft.	White	—	11723-7
			Red	—	11736-7
			Blue	—	11741-7
			Black	—	11742-7
MFP line with thimble	3/8"	100 ft.	White	—	11724-1



11723



11724

Hollow Braided Polypropylene Anchor Line

Available with Snap Hook or Thimble

Description	Thickness	Length	Color	OEM Part #	Part #
Polypropylene with snap hook	1/4"	50 ft.	White	—	11714-2
Polypropylene with spring hook	3/8"	50 ft.	Blue/White	—	11725-2
	1/4"	100 ft.	Blue/White	—	11722-2



11714



11725

Dock Lines

Attwood has a selection of dock lines to meet all boater needs for securing their boat to a dock or to other boats when rafting. Whether in nylon or polypropylene, we have dock lines in the most popular sizes and styles. Our nylon dock lines are the strongest and most durable lines available, plus they are resistant to the degradation effects of UV rays.

Our polypropylene dock lines are floatable. All Attwood dock lines are pre-spliced at one end.



3-Strand Twisted Nylon



Double Braided Nylon



Braided MFP



Hollow Braided Polypropylene



Premium 3-Strand Twisted Nylon Dock Line

Thickness	Length	Color	OEM Part #	Part #
3/8"	10 ft.	White	—	11711-7
	15 ft.	White	—	11705-7
1/2"	15 ft.	White	—	11706-7
	20 ft.	White	—	11733-7
	25 ft.	White	—	11715-7



11711

Premium Double Braided Nylon Dock Line

Thickness	Length	Color	OEM Part #	Part #
3/8"	15 ft.	Gold/White	—	11701-7
		White	—	117601-7
		Blue	—	117603-7
		Black	—	117604-7
20 ft.	Gold/White	—	—	117563-7
		White	—	117605-7
		Blue	—	117607-7
		Black	—	117608-7
25 ft.	Gold/White	—	—	117564-7
		White	—	117680-7
		Black	—	117681-7

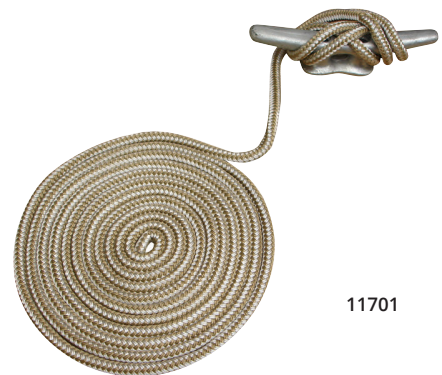

11701

Premium Double Braided Nylon Dock Line

Thickness	Length	Color	OEM Part #	Part #
1/2"	15 ft.	Gold/White	—	117565-7
		White	—	117614-7
	20 ft.	Gold/White	—	117566-7
		Black	—	117617-7
	25 ft.	Gold/White	—	117567-7
		Black	—	117621-7
30 ft.	Gold/White	—	117684-7	
	35 ft.	Gold/White	—	117525-7

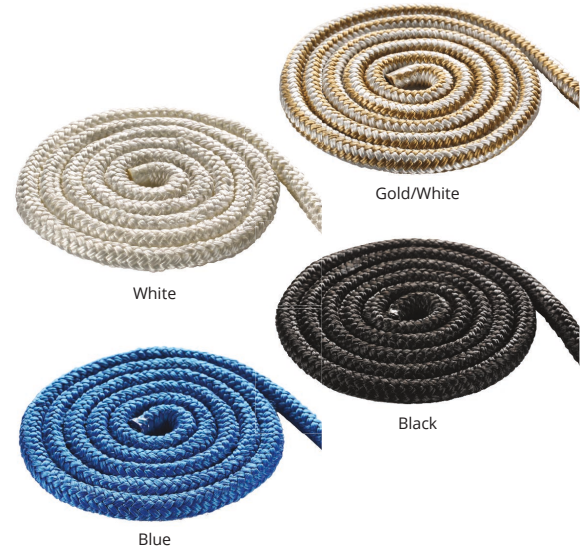

Braided MFP Dock Line

Description	Thickness	Length	Color	OEM Part #	Part #
Double Braided	3/8"	15 ft.	Blue	—	11702-7
			Black	—	11703-7
Solid Braided	3/8"	15 ft.	White	—	11737-7
			Red	—	11749-7
			Blue	—	11750-7
			Black	—	11752-7

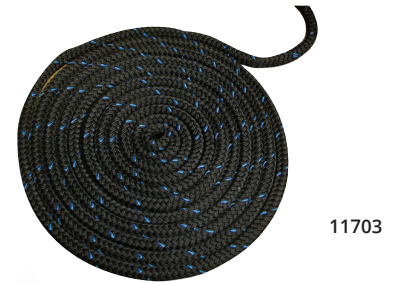

Mooring Snubber Kit

This flexible snubber stretches to absorb shock and protect boats, cleats, and lines from the strain of wind and water. The resilience of the snubber can be adjusted to conditions by increasing or decreasing the amount of line wrapped around it. Includes snubber and 20 ft. of solid braided multifilament polypropylene dock line.

Description	Thickness	Length	Color	OEM Part #	Part #
Mooring Snubber Kit	3/8"	20 ft.	Blue	—	11730-7



Hollow Braided Polypropylene Dock Line

- 15 ft. of hollow, braided polypropylene dock line
- All our polypropylene dock lines are floatable and pre-sliced at one end

Description	Thickness	Length	Color	OEM Part #	Part #
	3/8"	15 ft.	Blue/White	—	11728-2





11729

Expandable Dock Mooring Line

- Absorbs shock by stretching from 4 ft. to 5.5 ft.
- Convenient and easy to use -- eliminates excess lines
- Perfect for multiple boat tie ups
- Hollow-braid polyethylene line and shock cord construction

Length	Color	OEM Part #	Part #
4 ft.	Black	—	11729D5



11732

Launch Line

- Solid braid MFP line includes spring hook and handy foam grip
- Easy to handle floatable line that dries quickly
- UV Resistant
- Helps assist or steer your boat when launching or loading

Thickness	Length	Color	OEM Part #	Part #
5/16"	30 ft.	Blue	—	11732-7

Fender Lines

Attwood Fender Lines are constructed of double braided or 3-strand twisted nylon for strength, flexibility, and durability. These premium lines feature a professionally spliced eye and are available in a range of diameters, lengths, and colors. Our Fender Lines will not be damaged by oil, grease, gasoline, mildew, or most chemicals.

Double Braided Fender Lines

Description	Thickness	Length	Color	OEM Part #	Part #
Double Braided Nylon, pair	1/4"	5 ft.	White	—	11843-7
		6 ft.	White	—	11971-7



11843

Utility Ropes

We have just the unique rope product and accessory that are always practical and valuable for the many uses around the boat, marina and home.



11704

Braided Polypropylene Utility Line

- Multi color offering
- 75 foot offering comes in PDQ retail display of four ropes
- 25 foot offering comes in PDQ retail display of three ropes

Thickness	Length	Color	OEM Part #	Part #
3/8"	25 ft.	Multi	—	11704-2



11710

11713

Hollow Braided Polypropylene Utility Line

Thickness	Length	Color	OEM Part #	Part #
5/16"	50 ft.	Blue	—	11713-2
1/4"	40 ft.	Yellow	—	11710-2
	50 ft.	Yellow	—	11720-2
	100 ft.	Blue	—	11721-2



11700

Diamond Braided Polypropylene Utility Line

- Great for miscellaneous uses around the boat, home, and marina
- Neon multi-color offering

Thickness	Length	Color	OEM Part #	Part #
1/8"	45 ft.	Neon Multi	—	11700-2



11717

Camouflage Cord Utility Line

- Diamond Braided MFP Camo Cord
- Great for hunting, fishing, boating, and camping
- 75 foot offering comes in PDQ retail display of four ropes

Thickness	Length	Color	OEM Part #	Part #
1/8"	50 ft.	Camo	—	11717-2
	100 ft.	Camo	—	11718-2
1/4"	50 ft.	Camo	—	11719-2



11726

Twisted Nylon Utility Line

Thickness	Length	Color	OEM Part #	Part #
1/4"	50 ft.	White	—	11726-2



117553

Solid Braided Nylon Rope

Thickness	Length	Color	OEM Part #	Part #
3/16"	100 ft.	White	—	117553-7



117561

Diamond Braided Nylon Rope

Thickness	Length	Color	OEM Part #	Part #
1/4"	50 ft.	White	—	117561-2



11739

Winch Ropes

Durable winch ropes available in braided nylon and twisted polypropylene. For winches rated up to 1,200 lbs.

Thickness	Length	Material	Color	OEM Part #	Part #
3/8"	20 ft.	Twisted Polypropylene	Black	—	11739-2



11712

Marine Bungee Cord Pack

Ideal for boat covers and general use.

- High tensile strength steel hooks with protective coating
- Contains: (8) 24" White, (6) 30" Blue, (2) 42" Yellow and (2) Adjustable Hooks for customizing length

Description	Length	Color	OEM Part #	Part #
18 Piece Assortment	Multi	Multi	—	11712-7



11753

Flat Bungee Set

5-piece set includes 12", 15", 25", 35" and 45" premium flat bungees with plastic encapsulated hooks. Individual colors.

Description	Length	Color	OEM Part #	Part #
5-Piece Assortment	Multi	Multi	—	11753-7

Marine Rope Accessories

Rope Wraps

Wrap around and hold your ropes, cords, hoses, and more.

Description	OEM Part #	Part #
Three (3) 1" x 12" straps, with sewn in hook-and-loop fasteners	—	11792-6



11792

Fishing Rod Holders & Accessories

Make Attwood your fishing source

Now, more than ever, Attwood is your best source for adjustable rod holders and interchangeable mounts. We think you'll agree — Attwood's comprehensive selection has you covered for all types of rod holders!



5010



5009

Pro Series Rod Holders

Designed for use with bait casting and spinning reels. Heavy-duty, deep-tooth gear lock securely holds rod holder in mounting base.

Mount	Color	OEM Part #	Part #
Combo	Black	—	5010-4

Heavy-Duty Adjustable Rod Holders

Designed for use with bait casting and spinning reels. Features an ergonomic design and easy-to-find rapid-release latch. The large, easy-grip lock-nut offers an easy 180° vertical adjustment range for a variety of rod tip height settings.

Mount	Color	OEM Part #	Part #
Combo	Black	—	5009-4
	White	—	5009W4
Flush	Black	—	5014-4



RH-4646

2-In-1 Non-Adjustable Rod Holders

Features fixed vertical angle to optimize rod positioning. Smaller size is perfect for medium and light action gear. Rod throat opening fits most standard and ultra-light rods up to 1-3/16 inches diameter. Locking ring fits spinning reel handle shanks up to 7/16 inch diameter. Available as a double-pack.

Mount	Color	Pk Qty	OEM Part #	Part #
Side	Black	2-pack	—	RH-4646

Note - 2-In-1 OEM Packed Rod Holders include ID label with UPC number/bar code



5016
Heavy Duty
Rod Holder
Extension

5012
Heavy Duty
Rail Mount

5012/5011
Heavy Duty
Combo Mount
& Rail Mount



Heavy-Duty Rod Holder Extensions

For use with all Attwood mounts including combo mount, Attwood standard side mounts, and other leading rod holder mounts. Complete with all necessary hardware to mount to round or square 7/8 inch to 1-1/4 inch diameter rail.

Description	Color	OEM Part #	Part #
Extension	Black	—	5016-3



Heavy-Duty Rail Mount

For use with the Heavy-Duty Combo Mount. Complete with all necessary hardware to mount to rails from 3/4 inch to 1-1/4 inch width.

Description	Color	OEM Part #	Part #
Rail Mount	Black	—	5012-7



Heavy-Duty Combo Mounts

The combo rod holder mount allows for mounting in multiple configurations. This new design offers an improved fit with positive lock for secure rod holder mounting. Can be mounted on side or top of gunwale. Compatible with all Attwood and other leading rod holder mounting patterns.

Description	Color	OEM Part #	Part #
Combo Mount	Black	—	5011-7



5022

Flush Mounts

Mounts flush to gunwale or deck. Easy-open cover conceals fasteners and elastomeric liner seals water out. When closed the low profile, smooth, contoured design avoids snagging lines.

Description	Color	OEM Part #	Part #
Flush Mount	Black	—	5022-7



5030-4

Heavy-Duty Clamp-On Rod Holder Mount

Heavy-duty adaptor clamp easily mounts rod holder to gunwale or transom. Ideal for aluminum fishing boats and pontoons. Works together with Attwood's Heavy-Duty Combo Mount and other Attwood fishing accessories. Mounting hardware included.

Description	OEM Part #	Part #
Gunwale/Transom Rod Holder Clamp	—	5030-4



Clamp-On Rod Holder

Versatile Clamp-On Rod Holder features wide adjustability and a universal clamp design that allows easy mounting to gunwales, transoms, and rails. Constructed of powder coated steel for durability and long life.

Description	Color	OEM Part #	Part #
Clamp-On Rod Holder	Black	—	5031D1



Mini Rigger Kit

A complete package to start downrigger fishing. Attwood's Mini Rigger Kit bring controlled-depth trolling capabilities to boats of all size. Kit includes Heavy-Duty Combo Mount for multiple mounting configurations, heavy-duty and easy to use professional line release, swivel head pulley to respond to line movements, 100 ft. of stainless steel line, 4 lb. cannonball weight, and an easy grip handle.

Description	OEM Part #	Part #
Mini Rigger with Harness	—	9709-7



Lure Rack

The lure rack holds up to 25 lures, plus a fillet knife and pliers. Has slots for fillet knives.

Description	OEM Part #	Part #
Lure Rack	—	11848-4

Sure-Grip Steel Rod Holders & Mounting Bases

Attwood's line of Sure-Grip Steel Rod Holders are the perfect complement to our molded Pro-Series and Heavy-Duty Adjustable rod holders. They are designed for drift fishing, pan fishing, crappie, and more. Make Attwood your single source for all types of rod holders! The 3/8 inch diameter coated steel rod is tough, strong, and corrosion-resistant. UV-resistant plastic coating protects the rod butt and handle. Stainless steel exposed stem and wing nut offer years of corrosion-resistant use. Attwood Sure-Grip mounting bases fit a variety of mounting surfaces including rails. Constructed of extruded aluminum.

Sure-Grip Mounting Bases

Base	Fits	OEM Part #	Part #
Side mount base, fits	gunwale or rail	—	5070-3
Flush base, fits	2" flat surfaces	—	5071-3
Flat rail base, fits	square rail	—	5072-7
Clamp-on rail base, fits	round rail up to 7/8"-dia.	—	5074-3

Sure-Grip Stainless Steel Rod Holders

Angle	Stem Length	Use for	Includes	OEM Part #	Part #
5° Angle	4" w/ Wing Nut	horizontal rod position	5071 mounting base	—	5060-3
5° Angle	8" w/ Wing Nut	horizontal rod position with added clearance	5071 mounting base	—	5061-3
25° Angle	4" w/ Wing Nut	drifting or trolling	5071 mounting base	—	5062-3
			pair of rod holders and 5071 mounting bases	—	—
45° Angle	4" w/ Wing Nut	trolling	5071 mounting base	—	5063-3



5070



5071



5072



5074



5060



5061



5062



5063

Stainless Steel Flush Mount Rod Holders

Attwood Stainless Steel Rod Holders answer the need for the finest in finish, function, and durability. The holders are available in 30°, 15°, and 0° configurations in standard 2 inch diameter. All Stainless Steel Rod Holders have these outstanding features, including optional custom-casting or electrolytic etching of your logo in the flange. Contact your Attwood representative for details.

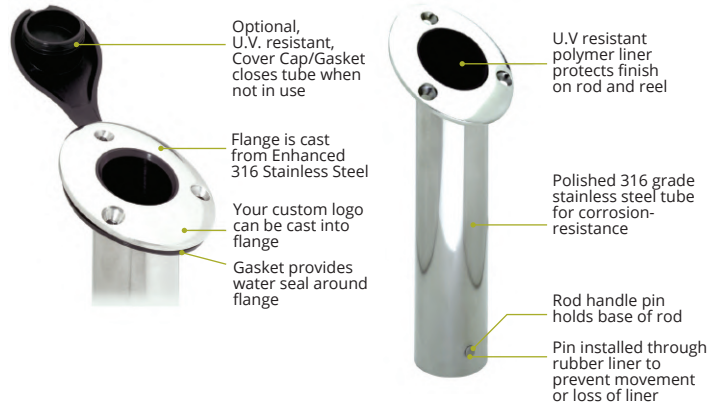

Closed End Rod Holders

• 2" Diameter x 9" Length

Description	Flange Shape	End Type	Gasket Color	OEM Part #	Part #
30°	Round	Closed	Black	66470-1	66470-7
0°	Round	Closed	Black	66471-1	66471-7



Standard Series Rod Holders

• 2" Diameter x 7-1/2" Length

Description	Flange Shape	End Type	Gasket Color	OEM Part #	Part #
30°	Oval	Open	Black	66362-1	66362-7 ▽
			White	66362W1	66362W7 ▽
15°	Oval	Open	Black	66363-1	66363-7 ▽
			White	66363W1	66363W7 ▽
0°	Oval	Open	Black	66364-1	66364-7 ▽
			White	66364W1	66364W7 ▽

▽ Includes Cap Gasket

Standard Series Cap Gasket

Description	Flange Shape	End Type	Gasket Color	OEM Part #	Part #
30°	Oval	Open	Black	1478-1	—
			White	1478W1	—
15°	Oval	Open	Black	1477-1	—
0°	Oval	Open	Black	1476-1	—

Standard Series



Hybrid Rod Holder

10 inch long ABS plastic tube with stainless steel cap.

Description	OEM Part #	Part #
30° angle	6450-1	—
0° angle	6451-1	6451-7



Plastic Rod Holders

Durable ABS plastic construction. No liner needed. Holder is angled at 30° for proper rod tip tension. Installation hole size: 2-1/2 inch diameter. Flange has three holes for 1/4 inch screws. Accommodates standard rod grip sizes under 1-1/2 inch diameter.

Description	Color	OEM Part #	Part #
Open	Black	—	12701-5
Open, 8 pc Display	White	—	12703D1
Closed end	Black	12704-1	—



Stainless Steel Clamp-On Rod Holder

304 stainless steel with black composite liner. Can be used on vertical or horizontal rails. Adjustable for rails 7/8 inch to 1 inch diameter. 9 inch length, 1-3/4 inch inside diameter tube.

OEM Part #	Part #
—	66970-7



Rod Storage

PVC Rod Holder Storage

Durable white PVC tube side mounts with molded out area to accommodate standard rod grip sizes up to 1-3/4 inches. 9 inches long.

OEM Part #	Part #
—	12708-2



Boat Deck Rod Holder Set

Mounts rod and reel combo to deck of the boat. Prevents rod and reel from bouncing out of boat while traveling. Holds up to five rods.

- Set includes: (1) 10 inch (25 cm) strap for the handle end of the rods, (1) 6 inch (15 cm) strap for the tips and stainless steel mounting hardware.

Description	OEM Part #	Part #
Deck Rod Holder Set	—	12760-7



Vertical Mount Rod Holder

- Mounts vertically in application to hold 5-6 rods horizontally
- Molded rubber inserts secure rod butt and tip
- Holds in a crisscross manner, allowing storage of more rods in a smaller space

Description	OEM Part #	Part #
Vertical Mount, Rod Holder Set	—	12761-7



Rod Storage Holder

Holds up to three fishing rods. Closed-cell foam insert protects rod. Mounts vertically or horizontally. 8-3/4 inches L x 2-1/2 inches W.

Description	OEM Part #	Part #
Black ABS frame, black foam	—	12750-6



Fishing Nets

Fold-N-Stow Fishing Nets

Fold down for convenient and compact storage or extend for added reach with Attwood's line of Fold-N-Stow Fishing Nets. A flip of the handle opens and locks the net into place. Easily pull back the trigger and the net collapses down into a stowable size. Constructed of durable, knot-free netting.

Size	Ideal for	Fully Extended	OEM Part #	Part #
Small	Trout Fishing	24" L x 12.5" W x 10" D	—	12772-2
Medium	Variety of Applications	47" L x 16" W x 16" D	—	12773-2
Large	Heavy Duty Applications	81" L x 27" W x 27" D	—	12774-2

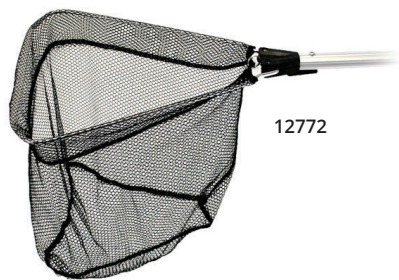

12772

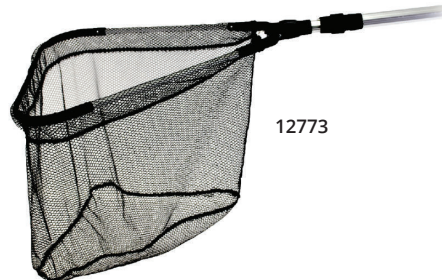

12773



12774

Marine Maintenance Products

SpillBuster™ Spout

Eliminate messy and potentially dangerous spills with this versatile spout that easily attaches to your oil and fluid bottles. On/off valve controls liquid flow. SpillBuster fits 1-quart, 1-gallon, and most 5-quart bottles. Removable cap seals shut.

OEM Part #	Part #
—	14584D1



14584D1

Deluxe Deck Brush Kit

Kit includes:

- Soft brush with squeegee end for gentle, scratch-free cleaning
- Telescoping aluminum pole with flow-through design has water on/off switch and comfortable foam grips
- Nylon boat hook attachment

OEM Part #	Part #
—	11807-2



11807



Spiral Watering Hose

- 3/4 inch end fittings
- Easy to store. No tangles, always kink-free.
- Weatherproof
- 3/8" I.D. x 25' Long

OEM Part #	Part #
—	11871-7



11871

Prop Wrench Kit

- Offers multiple sockets to fit from 17/32 inch to 1-1/4 inch, allowing consumers to service multiple props.
- Built of durable composite.
- Wrench with up to 1-1/16 inch prop nuts

OEM Part #	Part #
—	11370-7

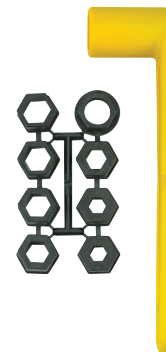

11370

Interior & Boating Accessories

Soft Grip Steering Wheel

Ideal steering wheel for bass boats, sport boats, and runabouts. Patented design provides a comfortable, and firm grip. Contemporary styling with soft, black PVC outer rim and high-impact, one-piece plastic inner core. Resists UV rays to prevent fading. Soft Grip is non-magnetic so it will not interfere with compass readings. 3-3/8 inches deep dish. Fits all standard 3/4 inch tapered shafts and conforms to ABYC P-22 and ISO 8848.

- 8315 NMMA "As Approved": 090071; CE Certificate WATT004

Description	Center Cap	OEM Part #	Part #
13"-diameter rim	Black plastic	—	8315-4



8315
with cap

Tiller Line Clamp

Two screws lock plates together to hold tiller lines in place. Die-cast ZAMAK with chrome finish.

Description	OEM Part #	Part #
For 3/16" to 1/4" dia. line	—	8043-3



8043

Standard Glove Box

Plastic box and door are light-weight, yet sturdy. Door opens and closes easily on a stainless steel hinge pin and locks with a marine locking latch.

Door Dimensions	Inside Dimensions	Installation Hole Size
13-3/4" L x 5-1/2" H	11-3/4" L x 4" H x 6-5/8" D	12" L x 4-1/4" H

Description	OEM Part #	Part #
Black	2638-1	—



2638

Letter & Number Kit

- 3 inch, waterproof vinyl, pressure-sensitive labels
- Resists fuel, fading, and scratches
- Kit contains: Four of each letter and number, plus twelve dashes totaling 148 pieces
- Meets USCG guidelines

Description	OEM Part #	Part #
White, 148 pieces	—	14141-7
Black, 148 pieces	—	14142-7



14142

Rope Ladder

White, five-step boarding ladder. Sturdy 11-3/4 inch blow molded steps. Textured step surface for sure footing. Steps connected by a nylon rope with top loop that quickly secures to cleat or railing.

Description	OEM Part #	Part #
Rope Ladder	—	11865-4



11865

Boat Horns & Safety Products

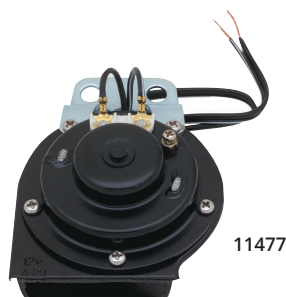

11477

Hidden Horn Kit

Mounts below deck, behind dash, or behind console. Meets ABYC standards for boats up to 16.4 ft. (5 meters), and USCG standards for boats up to 39.4 ft. (12 meters). Heavy-duty marine construction. For 12V DC systems only.

- 3" L x 3 1/4" W x 1 3/4" D

OEM Part #	Part #
—	11477-3



11478

Drop-In Hidden Horn

Low profile drop-in horn with grills. Design allows easy installation. Easily retrofitted. Comes with black and white cover. 12V DC. ABYC compliant with A-16 standards.

- Includes black and white cover

OEM Part #	Part #
—	11478-7



118091

Air Horn

Perfect for boating, sporting events, camping, and bicycles.

Description	OEM Part #	Part #
8 oz.	—	118092-7
8 oz. Refill Pack	—	118089-7



2460

Bellow Signal Horn

Lung-powered horn does not use CO2, Freon, or batteries. Designed for personal protection and safety on land and on water. Meets U.S. Coast Guard Rule 33 (Annex III) and Federal/EPA regulations.

- 8" H x 3 1/2" W

OEM Part #	Part #
2460-1	2460-7

Portable Spot Light

Compact 5-watt LED spot light can be stored most anywhere on the boat. Light output is 400 fixture lumens with 50,000 hours of life. Tough thermoplastic construction in safety yellow/black. Includes a 12V "cigarette-style" adaptor plug with fuse.

Description	OEM Part #	Part #
Compact Spot Light w/10' power cord	—	11794-7



11794

Boater Safety Accessories



11830

Bailer Safety Kit

Kit Includes: waterproof emergency flashlight, bailer with easy-grip handle, 50 ft. marine rope with float, Pealess flat safety whistle with lanyard, and seamless "O" Ring.

Description	OEM Part #	Part #
5-Piece Kit	—	11830-2

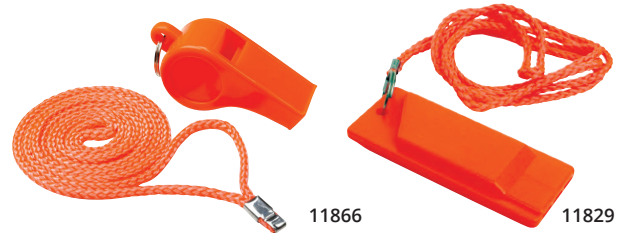

11866

11829

Whistles—Ball & Flat

- A perfect signal whistle for attaching to life vests
- Lanyard included

Description	Dimensions	OEM Part #	Part #
Plastic Ball Type	2-1/4" x 3/4"	—	11866-6
Plastic Flat Type	1-7/64" x 2-51/64" x 5/16"	—	11829-6



11875

Floating Key Buoy

- Water resistant
- Cover snaps tight for storage of small items
- Distinctive orange top for easy visibility

Description	OEM Part #	Part #
Floating Key Buoy	—	11875-7



11889

Key Floats

Prevent loss of keys when dropped overboard. Three colors: orange, white and blue, with Attwood logo.

Description	OEM Part #	Part #
PDQ Carton, 24-Piece	—	11889D1

Telescoping Paddle

- Compact for easy storage
- Telescopes to 42" (1.06m) or 54" (1.37m)
- High impact plastic blade with corrosion-resistant aluminum pole

Description	OEM Part #	Part #
Paddle, telescoping - 3.5'	—	11828-1
Paddle, telescoping - 4.5'	—	11826-1



11826-1

Mirrors

Note: In some states and provinces, ski mirrors of a certain size/dimension, and/or an onboard observer may be required. Check local requirements.

Wide View Ski Mirror

For installation on windshields 1/2 inch to 1 inch thick (or thinner with customer's own spacer). Provides extra-wide mirror for safe visibility. Molded plastic frame, polished convex mirror, and adjustable base (up-and-down or side-to-side, then secures in desired location). Includes Allen wrench.

Description	OEM Part #	Part #
11-3/4" W x 4" H, Adjustable	—	13065-4



13065

Chrome Ski Mirror

Universal mount installs on dash or windshield. Shatterproof, 180° convex mirror eliminates blind spots. Mirror is compact and constructed of lightweight, chrome plated ZAMAK. Mirror adjusts to any position up-and-down or side-to-side, then secures in desired location.

Description	Dimensions	Max. Windshield Thickness	OEM Part #	Part #
Perma-Plate®, Adjustable	7-5/16" W x 2-1/2" H	3/4"	—	9083-7
Chrome-plated, Adjustable	7" W x 3-1/4" H	1"	—	13055-4



9083



13055

Clamp-On Ski Mirror

Universal mount fits up to 1/2 inch thick window frames and adjusts easily to meet most boat applications. Curved mirror provides a wide field of view. Soft touch mounting clamps protect windows and frames. Zinc plated hardware and powder coated shaft assembly.

Max. Windshield Thickness	OEM Part #	Part #
1/2"	—	13066-7



13066

Drink Holders



11786B



11786W

LED Stainless Steel Drink Holders

Convenient and stylish LED drink holder makes it easy to see in low-light conditions. The vibrant 35 Lumen interior light ring comes in blue and white to complement all boat interiors. 12 VDC.

Dimensions	LED Color	OEM Part #	Part #
3.2" D x 3.6"-dia.	Blue	11786B-1	11786B-7
3.2" D x 3.6"-dia.	White	11786W-1	11786W-7



11631

Molded Plastic Gimbaled Drink Holders

Self-leveling drink holders with slot for coffee cup handle. For boats, cars, and RVs. Molded plastic. Includes gimbaled surface-mounting bracket. Self-draining.

Description	Color	OEM Part #	Part #
4" H x 4-3/8" W	White	—	11631-4
	Black	—	11635-4



Recessed Drink Holders

Available in sizes for a variety of cans, bottles, and glasses. Each has holes for self-draining.

Size	Dimensions	Color	OEM Part #	Part #
Regular	1-7/8" D x 3"-dia.	Black	11787-1	—
Deep	2-7/8" D x 3"-dia.	Black	11788-1	—
Large	3-1/8" D x 3-3/4"-dia.	Black	11789-1	—
Large	3-1/8" D x 3-3/4"-dia.	White	—	11789WD1
Large	3-1/8" D x 3-3/4"-dia.	Stainless Steel	11845-1	—



Formed Wire Gimbaled Drink Holders

Formed, chrome-plated steel drink holders are ideal for boats, cars, and RVs. Includes a gimbaled surface-mounting bracket that keeps drinks level to prevent spills. Includes mounting screws.

Description	OEM Part #	Part #
Standard, ideal for 12-ounce cans	—	11670-4
Large, with slot for mug handle, includes cooler	—	11672-4

Fold-Up Drink Holders

Two easy-to-use, fold-up designs. Holds coffee mugs with a handle, 12-ounce cans, or drink insulators. Mount quickly and easily on boats or RVs. On dual-ring models, flip the small ring up to hold small drinks; for large drinks, flip the small ring down and use the large ring. When not in use, flip ring(s) down and close the cover for convenient storage. 7/8 inch closed depth. Four holes for #10 screws.

Description		Color	OEM Part #	Part #
Dual Ring	Polycarbonate construction 4-5/8" H x 4-9/16" W x 4-3/4" D	Black	—	2445-7
		White	2449-1	2449-7
Single Rigid Ring	Molded ABS plastic 3-7/8" H x 3-3/4" W	Black	—	11654-3

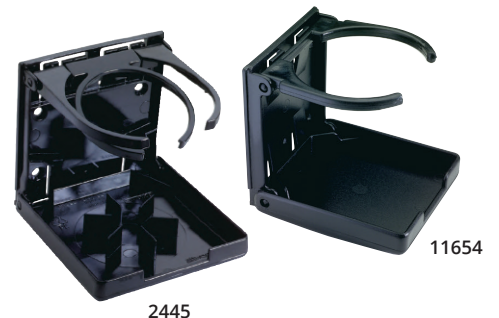

Storage Caddies

Storage caddies keep your boat organized. Easy-to-mount suction cups stay secure, even in rough conditions. Caddies can be mounted in back or on the bottom and can be permanently attached with screws. Non-corrosive white plastic.



Cockpit Caddy

Great organizer for fishing gear and personal items. Has slots for fillet knife, pliers, and over 22 lures.

OEM Part #	Part #
—	11849-2



Cruiser Caddy

Large storage space holds personal items and a beverage. Has slots for three lures and space for handled mug.

OEM Part #	Part #
—	11851-2



Safety Orange Boater's Box

Keep your maps, electronics, and other equipment safe while on the water.

- Perfect for use on the boat, at the dock, at home, or in the field
- The lift out tray is great for organizing small items and the flip-up lid provides easy access to your stored items
- Flip latch provides a secure method to keep your belongings safe

OEM Part #	Part #
—	11834-1



Cooler Mounting Kit

- Cooler corners stay put with straps to prevent injury or boat and cooler damage
- Quick disconnect strap design
- Corrosion resistant
- Fastens with #8 screws

Description	OEM Part #	Part #
Cooler Mounting Kit	—	14137-7



Dry Case Personal Storage

Heavy duty case protects personal gear and electronics. Waterproof up to 80 ft. Strong locking clasp and hinges. Includes carrying lanyard.

Size	Dimensions	OEM Part #	Part #
Large	7-1/4" x 4-3/4" x 1-5/8"	—	11896-1

Heavy-Duty Dry Bags

Heavy-duty, 500 denier PVC fabric construction in safety yellow with black accented components. Strong over-molded carry handle and lower draw straps for maximum compression.

Size	OEM Part #	Part #
40 Liter	—	11894-2
20 Liter	—	11897-2



11894

Electrical Accessories

PowerGuard Pro Battery Boxes **NEW**

Experience the difference of PowerGuard PRO Series Battery Protection

- Upward facing vents let gases out while reducing water in-take by 94% - vs. PowerGuard 27 Series.
- Polypropylene Composite material is impervious to acid leak and other external factors.
- Engineered spill channels direct water away from the battery.

With PowerGuard PRO, your battery is always within reach

- Folding entry panels provide easy access to the battery terminals without the need to remove the mounting strap.
- Versatile bidirectional design allows contact from any angle.
- Ergonomic handles provide more comfort when transporting the battery.

PowerGuard PRO takes security seriously

- Reinforced mounting hardware ensures the battery and box stay anchored.
- Spacer blocks are removeable to fit both Group 24 and 27 batteries.
- Snap locking lid gives confidence that the battery will remain secure.

POWER GUARD^{PRO}



Battery Box Description	Dimensions with Lid Installed		Color/Style	OEM Part #	Part #
	Internal Dimensions (L x W x H)	Outside Dimensions (L x W x H)			
PowerGuard Pro	13-1/8" x 7" x 11"	21" x 11-1/4" x 11-1/2"	Black, vented	9070-1	9070-7*
Accessories					
Mounting Hardware—Includes: PRO Mounting Strap, Stainless Steel Mounting Feet, Stainless Steel Mounting Screws				9015-1	9015-3
Battery Spacers				9016-1	9016-3

* Retail pack comes with two battery spacers

** Max battery height without terminals is 9-5/16"

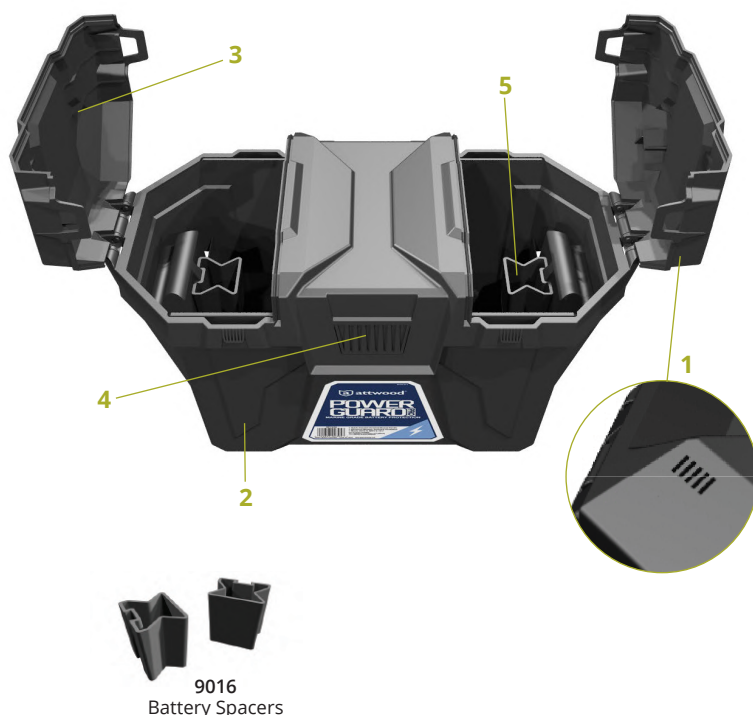

- 1 Water Resistant Ventilation:** Top facing ventilation minimizes water in-take through engineered spill channels, directing rain/ splash away from batteries.
 - 2 Polypropylene Composite:** Polypropylene composite provides vital durability needed to support heavy lead battery cells, while resisting any run-off and UV discoloration.
 - 3 Folding Terminal Entry Panels:** Easily run terminal connected wires through folding terminal access panels, without the need to remove mounting strap.
 - 4 Snap-Lock Lid Design:** Locking lid provides peace of mind that lid will remain secure even under the most extreme of conditions.
 - 5 Free-Play Reduction Blocks:** Free-Play Reduction Blocks help ensure that 24 series battery cells are kept secure within the box, reducing damage to box and battery alike.
- **Reinforced Mounting Hardware:** Mounting hardware consists of durable steel mounting feet and reinforced buckled strap to ensure box doesn't shift under heavy wave conditions.
 - **Bi-Directional Design:** Terminal Access Panels are positioned on either side of the box, allowing for maximum battery access.
 - **Ergonomically Designed Handles:** Ergonomic handles allow for easy transportation on and off vessels, trailers, and more.

PowerGuard Battery Boxes

Meet ABYC standard E-10 and U.S. Coast Guard Specification Number 183.420 as an OEM-installed battery hold-down system. Polypropylene construction for total acid resistance. Hold-down straps resist 350 lbs. of force, nearly four times the USCG requirement. Drop tested in temperatures ranging from -20°F to +120°F. Mounting hardware included.



9082

PowerGuard U1 Battery Box

For smaller batteries like Series 16 and those used in jet skis, power lawn, and garden equipment. Vented black battery box (5-7/8 inch maximum battery block height, 7-7/8 inch maximum battery height with terminals).



9065

PowerGuard 24 Battery Box

Vented and non-vented battery box for standard size, Series 24 batteries (8-3/16 inch maximum battery block height, 10-1/8 inch maximum battery height with terminals). Note: 9069 cover is non-vented and is not for marine use.

- Four cable openings, enlarged to .55 inch-diameter
- Larger handles with rolled edges
- Instructions molded inside cover



9084

PowerGuard 29/31 Battery Box

Vented black battery box for larger applications (7-15/16 inch maximum battery block height, 9-3/4 inch maximum battery height with terminals).



9067

PowerGuard 27 Battery Box

Vented black battery box for Series 27 batteries (8-1/2 inch maximum battery block height, 10-1/2 inch maximum battery height with terminals).

- Four cable openings, enlarged to .55 inch-diameter
- Larger handles with rolled edges
- Instructions molded inside cover



9076

Power Box, F27 Series

- LED battery level indicator with one-touch test button
- Heavy duty non-corrosive black plastic box
- Hold-down strap included
- 12V DC accessory adapter port with 10A fuse built-in
- External terminals

Battery Box Description	Battery Series	Dimensions with Lid Installed		Strap Length	Color/Style	OEM Part #
		Inside Dim. (L x W x H)	Outside Dim. (L x W x H)			
PowerGuard U1 Battery Box	U1	10-5/8" x 7" x 10-1/8"	11" x 7-1/2" x 8-3/4"	40"	Black, vented	9082-1
PowerGuard 24 Battery Box	24/24M/24F	10-5/8" x 7" x 10-1/8"	14" x 9-5/8" x 10-5/8"	40"	Black, vented	9065-1
					Black, non-vented	9069-1
PowerGuard 27	27/27F/27M	13-1/16" x 6-15/16" x 10-1/2"	16-7/8" x 9-5/8" x 10-7/8"	40"	Black, vented	9067-1
PowerGuard 29/31 Battery Box	29/31	15-7/16" x 6-15/16" x 9-3/4"	18-3/4" x 9-1/4" x 10-1/4"	38"	Black, vented	9084-1
Power Box	27F	—	—	44"	Black	9076-1

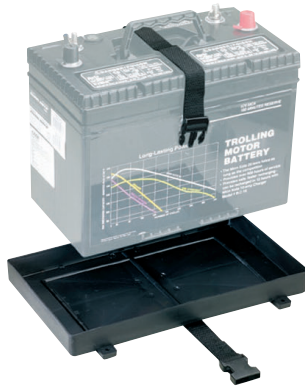

9092

Battery Tray with Straps

A simple-to-install battery holder that fits into limited spaces. For batteries up to 10-1/2 inches in height. Provide simple installation for changing or replacing batteries. The polypropylene hold-down strap has a positive locking, quick-disconnect buckle. Molded base mounts with four #10 panhead fasteners.

Battery Series	Inside Dimensions	OEM Part #	Part #
24/24M	7" L x 11" W	—	9092-5
27/27M	12-3/8" L x 7-1/8" W	—	9093-5
29/31	12-7/8" L x 7" W	9099-1	9099-5



9096

Heavy-Duty Battery Trays

Made of non-corrosive black plastic. Includes adjustable height crossbar and stainless steel retaining bolts. Meets ABYC Standard E-10 and U.S. Coast Guard requirements. Install with #10 fasteners.

Battery Series	Inside Dimensions	OEM Part #	Part #
24/24M	10-7/16" L x 6-7/8" W	9096-1	9096-5
27/27M	12" L x 6-7/8" W	9095-1	9095-5
29/31	13-1/16" L x 6-7/8" W	9094-1	9094-5



9097

Heavy-Duty Adjustable Battery Trays

Made of heavy-duty, non-corrosive, black plastic, this tray extends up to 9.5 inches, making it ideal for taller batteries. Includes adjustable-height crossbar and (2) retaining bolts. Contains no metal parts to corrode and no webbing straps to fade. Ergonomic nuts and bolts easily secure batteries. Meets ABYC Standard E-10 and USCG requirements.

- Rust-proof tray adjusts from 7-9.5 inches for taller batteries
- Made in the USA

Battery Series	Inside Dimensions	OEM Part #	Part #
24/24M/24F	10-5/8" x 6-3/4"	9097-1	9097-5
27/27M/27F	12-1/8" x 6-3/4"	9098-1	9098-5



9091

Low Profile Adjustable Battery Trays

Heavy-duty, non-corrosive black plastic. Includes adjustable-height crossbar and two retaining bolts. Meets ABYC Standard E-10 and U.S. Coast Guard requirements. Patented design. Install with #10 fasteners.

Battery Series	Inside Dimensions	OEM Part #	Part #
24/24M	10-5/8" x 7-1/4" x 8-1/2"	9090-1	9090-5
27/27M	12-5/8" x 7-1/4" x 8-1/2"	9091-1	9091-5

Battery Box Hold-Down Straps and Hardware

Straps are woven polypropylene with firm-grip buckles and are completely resistant to battery acid. Kit includes (4) #8, 3/4 inch screws and two footman clamps.

Description	Fits Battery Box(es)	OEM Part #	Part #
40" strap kit	9065, 9065A, 9067, 9082, 9069	9013-1	9013-3
40" strap only	9065, 9065A, 9067, 9082, 9069	9014-1	9014-3
54" strap kit	9084	—	9013A3
54" strap only	9084	9014A1	9014A3
Mounting hardware	—	9006-1	—



9013



11900

Battery Maintenance Charger

Fully-automatic on-board charger provides a 1.5 amp maintenance charge. Designed to maintain 12 volt batteries. Water-resistant with safety features, such as short circuit connection and reverse polarity protection. LED status indicators.

Specifications	OEM Part #	Part #
1.5A, 12V, 1 bank operation	—	11900-4



11901

Battery Charger

Dual rated 12V and 6V battery charger can be used for all of your marine, automotive, RV, and sport applications. The charger is compact and perfect for your bench, garage, or shop use. LED indicators let you know that your battery is fully charged. Overcharge, short circuit, and reverse polarity protection provide years of worry-free use.

Description	OEM Part #	Part #
12V/6V, 6A/2A Battery Charger	—	11901-4



14215

Polarized/Wing Nut Battery Terminals

Lead terminals with wing nuts and cadmium-plated bolts. Clamps are stamped with negative (-) or positive (+) sign.

Description	OEM Part #	Part #
Negative and positive, set	—	14215-6



14258

Battery Clips

Quick-connect battery clips for 12V electrical accessories. 10A rated, copper-plated construction with red and black handle grips. For use with wire up to 10-gauge.

Description	OEM Part #	Part #
Set	—	14258-6
Individual, Black	14258B1	—
Individual, Red	14258R1	—

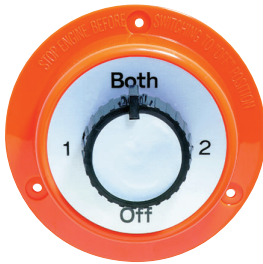

14230

4-Way Battery Selector Switch

Single-pole, triple-throw switch permits four connection modes: battery one, battery two, two batteries in parallel, or both off. Rated for 300A continuous at 6V DC and 150A continuous at 12V DC. For 6V to 32V DC systems. Includes alternator field circuit disconnect to prevent surges. Selector has positive click positions. Bakelite housing with copper washers, brass terminals, and brass nuts. Install with #10 screws.

Description	OEM Part #	Part #
5-1/2" dia. x 2-3/4" deep	—	14230-3

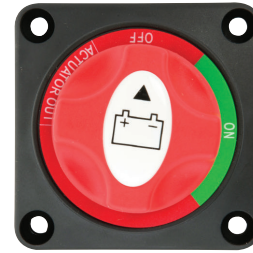

14233

Battery Switch

Compact and heavy-duty battery switch with removable control knob to deter theft. 12-50V DC / 200A continuous / 300A intermittent / on-off-separate.

For use with one battery.

- Ergonomic grips
- Removable walls for easy installation and access

Description	OEM Part #	Part #
12-50V DC, on/off	—	14233-7



14234

Dual Battery Selector Switch

Compact and heavy-duty battery switch with removable control knob to deter theft. 12V DC—Off/1/1+2/2 12V DC / 220A continuous / 400A 5 min intermittent / off. For use with up to two batteries.

- Ergonomic grips
- Removable walls for easy installation and access

Description	OEM Part #	Part #
12V DC, off/1/1+2/2	—	14234-7

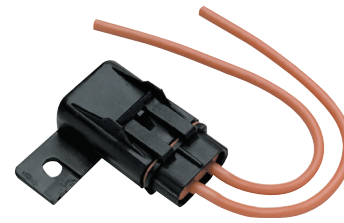

14348

ATO/ATC Fuse Holder

Watertight, extra heavy-duty, and weatherproof. For use with fuses up to 30A. 12-gauge wire leads for easy hook-ups. Fuse not included.

Description	Wire Size	OEM Part #	Part #
30A	12-gauge	—	14348-6

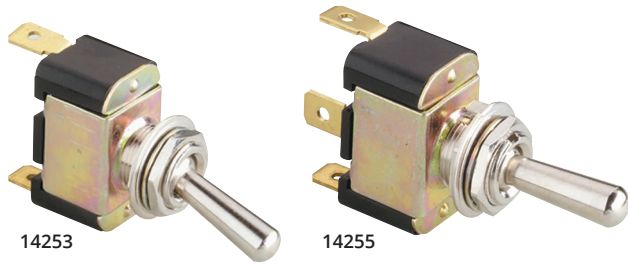

Toggle Switches

These metal toggle switches have 1/4 inch spade terminals. Rated for 10A, 12V DC only. Plastic body and housing with metal toggle and ring. Not external ignition protected.

On/Off Switches: Single-pole, single-throw contact. For lights, bilge pumps, or blowers.

On/Off/On Switches: For bilge pump, speed selector, or light that requires two power settings. Single-pole, double-throw contacts.

Installation Hole Size	Overall Dimensions	Depth Behind Panel	Max. Panel Thickness
3/8"-dia.	1-1/8" L x 5/8" W"	1-3/8"	1/4"

Description	OEM Part #	Part #
On/Off switch	—	14253-3
On/Off/On switch	—	14255-3



Boat Kill Switch Key Set

- Includes seven keys to fit Johnson, Evinrude, Mercury, Yamaha, Suzuki, Tohatsu and Honda kill switches
- Swivel snap hook prevents tangles
- Rust resistant stainless steel crimps
- Corrosion proof

Description	OEM Part #	Part #
Kill switch keys and lanyard	—	7591-6

Battery Adapter

Brass and plastic accessory plug for use directly with the battery. 150 watts. Comes with 3 ft. of wire, 12A, 12V.

Description	OEM Part #	Part #
Battery Adapter, 12 volt	—	11861-6



Push/Pull Switches

These switches have large easy-to-pull handles. They are commonly used for operating lights. 3/4 inch-diameter chrome-plated knob with brass case. Includes screw terminals for connection without a wire lug. For 12V DC only. Not external ignition protected.

Two-position Switch, Off/On: For operating one set of lights or another accessory.

Three-position Switch, Off/On/On: For operating running lights and anchor lights separately.

Installation Hole Size	Overall Dimensions	Depth Behind Panel	Max. Panel Thickness
3/8"-dia.	3-1/8" L x 1-1/4" W	1-1/2"	1"
3/8"-dia.	3-1/4" L x 1-1/2" W	2"	1"

Description	OEM Part #	Part #
Two-position	7563-1	7563-6
Three-position	7594-1	7594-3

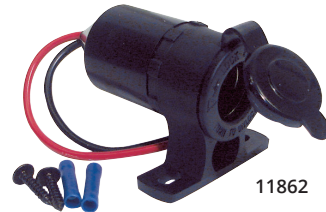

12V Marine Outlet

Marine quality 12V outlet is designed for replacing or adding outlets in your boat, RV or camper.

Description	OEM Part #	Part #
Surface Mount, 12V, Outlet	—	11862-6



14258

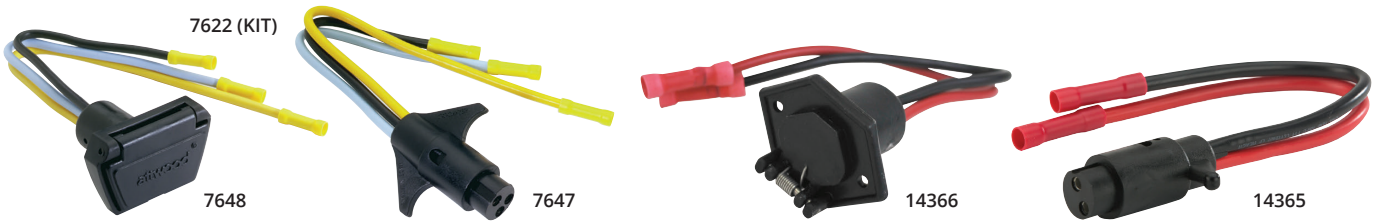

Heavy-Duty Trolling Motor Connectors

Use these connectors for quick, convenient connections between an electric trolling motor and a power source. 6 inch long wire harnesses with butt connectors.

Female Receptacle has weather cover and small face plate for flat surface mount. Two holes for #8 fasteners.

Male Plug has wing-tabs for easy installation and removal.

Plate Dimensions	Depth Behind Panel	Installation Hole Size
2-9/16" W x 1-3/4" H	2-1/4"	1-1/8"-dia.

Description	Wire Size	Volts	OEM Part #	Part #
Female receptacle, boat side	3-Wire 10-gauge	12/24V	—	7648-7
	2-Wire 8-gauge	12V	—	14366-6
Male plug, motor side	3-Wire 10-gauge	12/24V	—	7647-7
	2-Wire 8-gauge	12V	—	14365-6
Male/Female Kit	3-Wire 10-gauge	12/24V	—	7622-7



Medium-Duty Trolling Motor Connectors

Use these molded rubber connectors for quick easy connections between an electric trolling motor and the power source. 5 inch long harness with butt connectors. Receptacle (14350) includes weather cover and small face plate for flat surface mount. 10-gauge wire. For 12V DC only. Two holes for #8 fasteners.

Plate Dimensions	Depth Behind Panel	Installation Hole Size
2-1/2" W x 1-3/4" H	2-3/4"	1-1/8"-dia.

Description	Wire Size	OEM Part #	Part #
Female receptacle, boat side	10-gauge	—	14350-3
Male plug, motor side	10-gauge	—	14352-3

Trolling Motor Quick Connect

Safe and easy quick disconnect system. For use where a plug and socket cannot be used. Heavy-duty, 10-gauge connector, 22 inches long. Replaces battery clips.

Description	Wire Size	OEM Part #	Part #
2-Connector Kit	10-gauge	—	14367-6

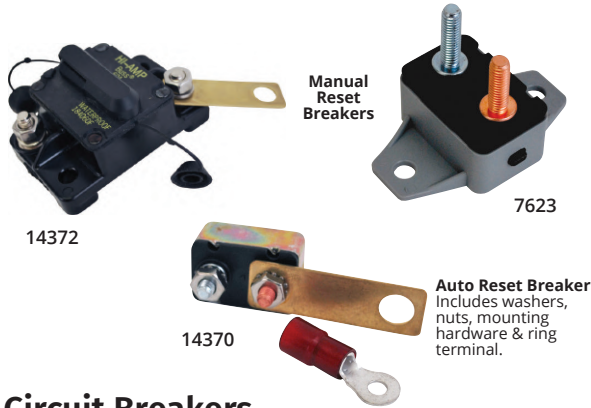

Circuit Breakers

A circuit breaker is an automatically operated electrical switch designed to protect an electrical circuit such as your trolling motor, or anything else electrical in your boat, from damage caused by overload or a short circuit.

Description	OEM Part #	Part #
60A Manual Reset with Ring Terminals	—	14372-7
50A Manual Reset	—	7623-7
Auto Reset with Ring Terminals	—	14371-6
40A Auto Reset with Ring Terminals	—	14370-6

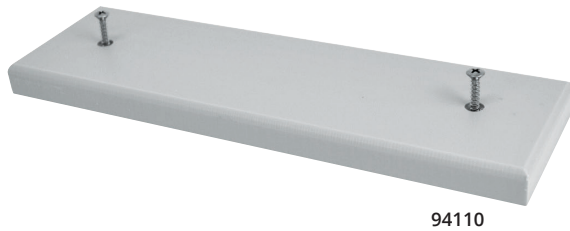

94110

Transducer Mounting Plate

- Mounts easily with only two screws
- Easy to adjust, add, or replace transducers.
- Marine-grade polymer plate will not warp, corrode, or be affected by UV rays.

Description	OEM Part #	Part #
Transducer mounting plate and hardware	—	94110-5



14361

Copper Wire

Stranded copper core is flexible for easy installation and allows the most current for quick starting. PVC insulation in the wire is resistant to cracking, abrasion, weather, oil, and acids.

Description	OEM Part #	Part #
8-ga. Red/Black, 20', set	—	14361-5



94100

Quick-Release Trolling Motor Mate Mounting Plate

For use with MinnKota® wireless trolling motors: AutoPilot, Grip Glide, Powerdrive, Terrova, RipTide ST and RipTide SP models

- Unique design eliminates tarp damage
- Easy on / easy off mounting - removes in seconds
- Exclusive locking feature
- Marine grade powder coat finish

Description	Part #	OEM Part #
Motor mate mounting plate and hardware	94100-4	—

Paddlesports & Accessories

Canoe Paddles

Aluminum Paddles

Heavy aluminum and rugged plastic construction. Ergonomic grip design. Poly-protective shaft grip.

Wooden Paddles

Economical and lightweight. Palm grip. Varnish finish.

Description	OEM Part #	Part #
Aluminum Paddles		
4 ft. Length	11764-1	—
4 ft. Length (Camouflage Green Blade)	11759-1	—
5 ft. Length	11765-1	—
Wooden Paddles		
2-1/2 ft. Length	11760-1	—
4 ft. Length	11761-1	—
5 ft. Length	11762-1	—



Stand-Up Paddle Board (SUP) Paddle

Paddle easily adjusts from 55 inches to 82 inches allowing families to share a SUP board. Constructed of heavy-gauge aluminum and engineered plastic components. Durable aluminum shaft with cupped 10° blade for increased efficiency and performance. Glass-filled ABS blade construction for long-term durability.

- Blade color – white
- Black, polypropylene grip
- Designed and engineered in the USA

Description	OEM Part #	Part #
SUP Paddle	—	11772-1

Kayak Paddles

Straight-Blade Paddles

Heavy aluminum and rugged plastic construction. Two-piece breakdown design is ideal for storage and compact transport. Drip rings included. Soft foam grips.

Asymmetrical Paddles

Asymmetrical spoon blade paddles are designed to increase efficiency of stroke performance and reduce noise and blade flutter in the water. Made from heavy-duty aluminum and engineered plastic construction. Two-piece breakdown design with multiple angle positions that allow for customization for each paddler.



Description	OEM Part #	Part #
Straight Kayak Paddles		
7 ft. Length	11763-1	—
Asymmetrical Kayak Paddles		
7 ft. Length	11768-2	—
7-1/2 ft. Length	11766-1	—

Vibrant Asymmetrical Paddles

Unique blade shape increases stroke efficiency and minimizes flutter in the water. The combination of performance and vibrant colors create an expressive kayaking experience. Paddle angles can be adjusted when attached together for a more customized stroke based on skill level for both left and right-hand users.

- Graphics and vibrant color on each blade
- Tested for performance and durability
- Stay dry with pre-attached drip rings

Description	Color	OEM Part #	Part #
7 ft. Length	Orange-Red & White-Gray	—	11756-2
7-1/2 ft. Length	White-Koi Blue & Key Lime	—	11757-2
Adjustable, 7 ft.-7-1/2 ft.	Black	—	11758-2





11826-1

Telescoping Paddle

- Compact for easy storage
- Telescopes to 42" (1.06m) or 54" (1.37m)
- High impact plastic blade with corrosion-resistant aluminum pole

Description	OEM Part #	Part #
Telescoping - 3.5'	—	11828-1
Telescoping - 4.5'	—	11826-1



11909

11912

Paddle Lanyards

Use the Standard Lanyard's sturdy clip or the Premium's velcro strap to secure your paddle and prevent dropping it overboard. Coiled bungee cord allows for advanced paddling with easy stowage.

Description	OEM Part #	Part #
Standard	—	11909-7
Gear Accessory Leash, 36"	—	11912-5

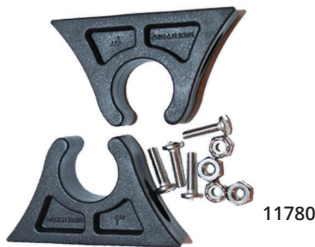

11780

Paddle Clips

Secures paddles for freeing up both hands or resting from paddling. Fits 1 inch diameter shafts.

Description	OEM Part #	Part #
1" diameter	—	11780-6



11944

Kayak Handle Replacement Set

Tough but comfortable, designed kayak carry handles for replacement on most kayak types and brands. The contoured grip makes carrying your kayak easier and more comfortable. Easy installation. Durable, black plastic and strong, braided rope.

Description	OEM Part #	Part #
Package of two	—	11944-7



9146

Oarlock Shanks

Made from heavy-gauge steel with a bright zinc finish. Adjustable and very easy to install; no holes to drill, clamp-on easily. One pair.

Description	OEM Part #	Part #
1/2" Shank, Pair	—	9146-6



9149

Oarlock Sockets

These heavy-duty sockets are made of heavy gauge steel designed to provide years of rugged use. The unique angle design allows for secure attachment to the boat that can outlast most original equipment sockets. One pair.

Description	OEM Part #	Part #
1/2" Socket, Pair	—	9149-6



11808

Rescue Line Throw Bag

50 ft. of 3/8 inch floating polypropylene line for water rescues. High visibility red bag with wide, yellow reflective strip for improved visibility in low light conditions.

Description	OEM Part #	Part #
50 ft.	—	11808-2



11776

Kayak Skirt

Keep water out of the kayak with this universal-fit spray skirt made with polyurethane-coated 210 Denier nylon. Dual-side adjustability and PVC-sealed seams. Mesh bag included.

- Universal (up to 40" long and 22" wide opening)

Description	OEM Part #	Part #
Kayak Skirt	—	11776-5



11778

Sit-On-Top Kayak Seat

Attwood's adjustable kayak seat provides a padded seat cushion and ample back support. Universal sizing for all sit-on-top kayaks. Four adjustable straps for a custom fit. Quick-drying, UV-resistant fabric with corrosion-resistant hardware. Durable nylon covering with additional storage bag on back of seat.

Description	OEM Part #	Part #
Foldable, clip-on kayak seat - Black	—	11778-2



11595

11596

Hand-Operated Bilge Pumps

Safely remove unwanted water, and other liquids from kayaks and other small boats.

Description	OEM Part #	Part #
Kayak Hand Bilge Pump, 18"	—	11595-2
Hand Bilge Pump, 25", 32" Hose	—	11596-2



11775

Kayak Cockpit Cover

Universal-fit cover made with 210 Denier nylon. Has a 3/16 inch shock cord border and black, polypropylene clips.

- Universal (up to 40" long and 22" wide opening)

Description	OEM Part #	Part #
Kayak Cockpit Cover	—	11775-5



12794

Deck Plates

Allow addition of storage options to your canoe, kayak, or small boat. Screw out design. High-impact ABS plastic is durable, rugged, and weather-resistant.

Description	Color	Fastener Quantity	OEM Part #	Part #
4"-dia.	White	#8 fasteners (6)	12790-1	12790-3
	Black	#8 fasteners (6)	12791-1	—
6"-dia.	White	#8 fasteners (6)	12792-1	—
8"-dia.	White	#8 fasteners (6)	12794-1	—

Paddlesports Hardware

Pad Eyes

All pad eyes are pre-drilled with two mounting holes.

- (2) #10 fasteners included

Description	A (Dia)	B (Long)	C	D	OEM Part #	Part #
Cast Stainless Steel	3/8"	1-7/8"	1-3/8"	1/2"	66105-1	—
Chromed bronze	5/16"	1-7/8"	1-3/8"	1/2"	12988-1	—



12988-1

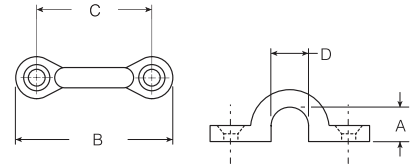

11783

Nylon Cleats

Ideal for tying off an anchor or for temporary docking. Includes (2) strong 4 inch lightweight cleats. Pre-drilled for #12 screws.

Description	OEM Part #	Part #
Nylon Cleats, set	—	11783-7



11950

11926

Zig-Zag Cleats

Makes a great primary cleat on kayaks, canoes, fishing boats and pontoons. Also good as a utility cleat on docks, piers, trailers, and more. 4 inch model handles rope up to 1/2 inch diameter. 3 inch and 3-1/2 inch models handle rope up to 3/8 inch diameter. One pair.

Description	OEM Part #	Part #
Zinc Plated, Pair	3"	—
	4"	—
Black Nylon, Pair	3-1/2"	—
		11950-6
		11951-6
		11926-7

Paddlesports Transportation & Storage

Canoe Car-Top Carrier Kit

Simple, convenient kits for carrying canoes and small boats on car roof. Includes four supporting foam blocks that snap on boat's gunwale and help prevent scratches on car top. Two straps with adjusting buckles and clips. Includes 20 ft. of polypropylene rope and S-hooks to secure bow and stern to bumpers. Straps are sturdy poly web with vinyl-coated clips.

Description	OEM Part #	Part #
Car-Top Universal Canoe Carrier Kit	—	11437-7



11437

Kayak Car-Top Carrier Kit

Simple, convenient kits for carrying kayaks on car roof. Includes two supporting foam blocks to support kayak and help prevent scratches on car top. Two straps with adjusting buckles and clips. Straps are sturdy poly web with vinyl-coated clips.

Description	OEM Part #	Part #
Car-Top Kayak Carrier Kit	—	11438-7



11438

Kayak Roof Rack – J Style

Easy to install kayak carrier mounts securely and safely to most standard and aftermarket roof rack cross bars. J-style design allows for easy loading and unloading of kayaks. Durable powder-coated steel construction holds up to 120 lbs. Foam rubber protection pads and detailed instructions included.

Description	OEM Part #	Part #
Kayak Roof Rack Carrier Kit	—	11441-4



11441

Kayak/Canoe Cart

Haul your kayak easier than ever with Attwood's new Kayak/Canoe Cart, now with premium wheels! Enhanced large diameter wheels cannot deflate, simplifying transport over uneven terrain. Cart easily disassembles to fit into most kayak hitches. Holds up to 100 lb. loads.

Description	OEM Part #	Part #
Kayak & Canoe Cart	—	11930-4



11930

Kayak Hoist System

Complete hoist system for kayaks, canoes, bikes, ladders, and more. Hooks and locking mechanisms safely hold up to 120 lbs. Easy lifting pulley system and 2 inch wide webbing hang straps. Includes all mounting hardware.

Description	OEM Part #	Part #
Kayak Hoist System	—	11953-4



11953



Trailer Parts & Accessories



14060

Submersible Trailer Light Kit

Complete kit includes a pair of 8-function stop/tail/turn lights, wiring harness, and license plate bracket. Applicable to trailers under 80 inches wide. Ideal for utility, snowmobile, camping, motorcycle, and boat trailers. Design conforms to applicable US FMVSS and Canadian CMVSS safety standards.

Description	OEM Part #	Part #
Submersible Kit	—	14060-7



14063

Low-Profile Submersible Trailer Light Kit

Low profile for trailers over 80 inches wide. The complete kit includes (2) multi-function lamps, wiring harness, license plate bracket, and mounting hardware. Ideal replacement lights for most boat trailers. Conforms to applicable U.S. FMVSS and Canadian CMVSS safety standards.

Description	OEM Part #	Part #
Low-Profile Submersible Trailer Light Kit	—	14063-7

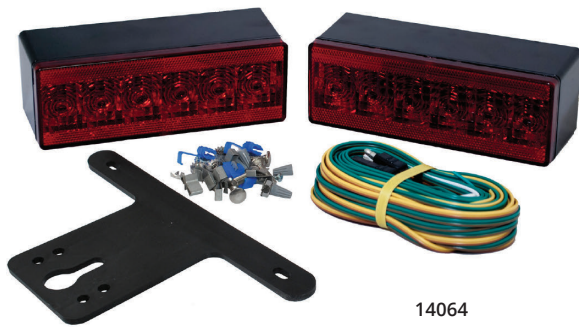

14064

LED Low-Profile Trailer Light Kit

Complete kit includes (2) multi-functional (stop/tail/turn) submersible low-profile LED trailer lights, license plate bracket, wiring harness, and installation hardware. Ideal replacement or upgrade for most trailers. Conforms to applicable U.S. FMVSS and Canadian CFMVSS standards.

Description	OEM Part #	Part #
Low-profile LED Light Kit	—	14064-7



14065

Submersible LED Trailer Light Kit

Complete kit includes (2) multi-functional (stop/tail/turn) submersible LED trailer lights, license plate bracket, wiring harness, and installation hardware. For use with trailers under 80 inches wide. Conforms to applicable U.S. FMVSS and Canadian CFMVSS standards.

Description	OEM Part #	Part #
Submersible LED Light Kit	—	14065-7



14066

Trailer Guide Lights

Trailer guide lights aid in backing and maneuvering trailers at boat ramps and in tight areas. Waterproof, bright red, LED lights make it easy to identify trailer angle and position, even in low light conditions. Mount to trailer frame or guidepost with corrosion-resistant aluminum and steel mounting. Mounting hardware not included.

Description	OEM Part #	Part #
Trailer Guide Light Assembly 27" L x 1/4" dia.	—	14066-7

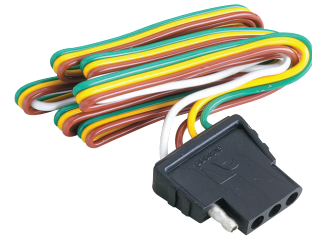

14017

Trailer Wiring Harness/Connectors

The most popular 4-way flat wiring harness kit for vehicles and trailers. Copper-stranded, color-coded wire and plastic molded terminals with four-prong trailer plug or vehicle socket. Both ends have 18 inch plug wire and 48 inch socket wire.

Description	OEM Part #	Part #
18" plug and 48" socket	—	7663-5



7621

Complete Trailer Wiring Kit

Kit Includes: (1) Receptacle and harness, 4 ft. (1.2 m), (1) plug and harness, 25 ft. (7.6 m), (4) blue quick connectors and (8) trailer wire attachment clips.

Description	OEM Part #	Part #
Complete Wiring Kit	—	7621-7



14133

Trailer Light Circuit Testers

The light indicators on this inline circuit tester show which circuit (tail lights, ground, left-or-right signal) is having problems.

Description	OEM Part #	Part #
Circuit Tester, Inline	—	14133-6

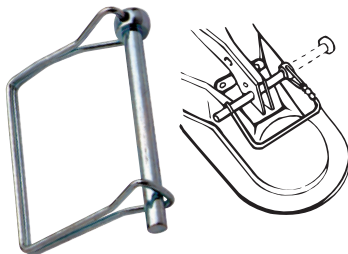

11029

Coupler Locking Pin

Quick connect and disconnect, to keep coupler from accidentally disengaging. Fits 2 inch and 3 inch couplers. Pin fits through coupler release handle to provide security and safety.

Description	OEM Part #	Part #
Solid zinc-plated steel, 2-1/4" W x 1-5/8" L	—	11029-6



12044

Coupler Security Lock

For maintenance-free trailer security. While this lock is in place, coupler cannot be used. Solid brass with rust-proof stainless steel shackle pin. Includes two keys.

Description	Shank Length	Dia	OEM Part #	Part #
Coupler Security Lock	5/8"	1/4"	—	12044-6



11011

Trailer Safety Chain with Spring Clips

Connects the trailer tongue to the trailer hitch on the towing vehicle for security and safety. Meets SAE specifications. Welded, solid steel with bright zinc-plated finish and hooks at both ends. Two chains required per trailer.

Description	Specifications	OEM Part #	Part #
Class II	51" L x 1/4" dia.	—	11011-7



11127

11126

Fold-Up Trailer Jacks

Fits 3 inch x 5 inch tongue. Swings up and out of the way. Corrosion-resistant, zinc-plated steel tubing. Swing-up jack has a convenient sidewind handle and a tough 6 inch diameter polypropylene wheel.

Description	Travel Lift	Lift	OEM Part #	Part #
1000 lbs. capacity, single wheel	10"	24"	—	11127-4
1500 lbs. capacity, dual wheel	12"	26"	—	11126-4



11130

Trailer Tongue Lift Handle

Convenient handle for maneuvering trailer tongue. Mounts easily to most trailer couplers.

Description	OEM Part #	Part #
Lift Handle	—	11130-7



6260

Non-Skid Pads

Precision 6 inch x 12 inch die-cut pads are simple to install on trailers, boats, and docking for additional safety. Rugged anti-slip surface is 100-grade coarse grit. A proven adhesive ensures long-lasting performance.

Description	OEM Part #	Part #
Non-Skid Pads, pair	—	6260-4



11401

Pontoon Storage Blocks

Great for fall and winter pontoon storage. Stable design keeps pontoon hull dry and off the ground. High-density, engineered composite protects pontoon surface. Conveniently stack together when not in use. Each block holds 4,000 lb. capacity. Lightweight and easy to use. Will not absorb moisture.

Description	OEM Part #	Part #
Pontoon Storage Blocks Set of 4	—	11401-4

Trailer Winches

Many Factors Affect The Capacity Of A Winch In Pulling A Boat. As A Rule Of Thumb, Winches May Be Used To Trailer Boats Up To Two Times The Winch Capacity. For Example, A 1200-Lb. Capacity Winch May Be Used To Load Boats Up To 2,400-Lbs.

Caution: Attwood Winches Are Not Intended For Use As Hoists; For Lifting, Supporting, Or Transporting People; Nor For Lifting Loads Over People.



Dual Drive Winch—2,000 pound

Dual drive enhances the pulling capacity by distributing the load equally to two sets of gears. Eliminates frame torque. 2,000-lb. load capacity with 4.1:1 gear ratio. Three-position pawl provides forward, neutral, and reverse operations. Black EDC finish. Molded, textured roller grip. Includes 2 in x 20 ft. nylon web strap with zinc-plated snap hook.

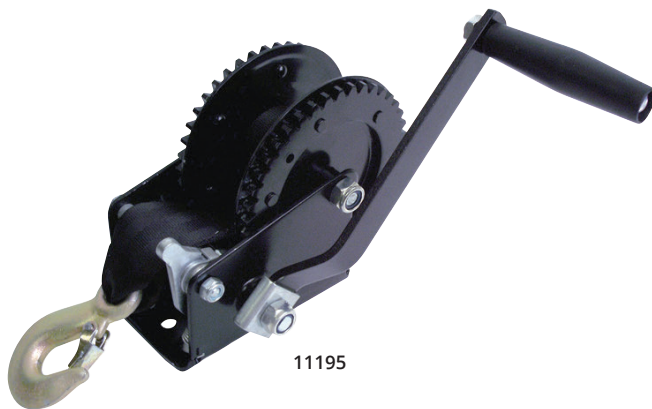

11195

Single Drive Winch—1,200 pound

Solid gear construction with precise gear tooth engagement. 1,200-lb. load capacity with 4.1:1 gear ratio. Three position pawl provides forward, neutral, and reverse operations. Black EDC finish. Molded, textured roller grip. Includes 20 ft. nylon web strap with zinc-plated snap hook.

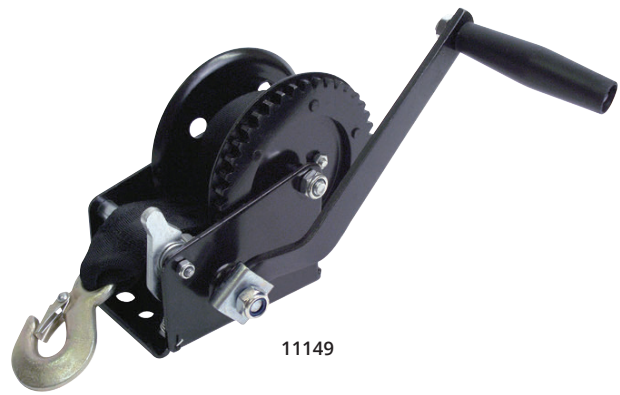

11149

Description	Type	Gear Ratio	OEM Part #	Part #
2000 lb. with 2" W x 20' L nylon strap	Dual	4.1:1	—	11195-4
1200 lb. with 2" W x 20' L nylon strap	Single	4.1:1	—	11149-4



Trailer Winch Straps

Winch straps, cables, and ropes are available to fit most winches, loads, and applications. A complete selection of winch products to meet every customer need and a variety of price points.

Selecting a winch strap, rope, or cable: NMMA, SAE, and BIA Standards require the minimum breaking strength of winch cable, rope, strap, and hook be at least 1.5 times the rated straightline pull of the winch. For example, if a winch rope has a breaking strength of 1,500 lbs., it can only be used on winches rated up to 1,000 lbs. All Attwood winch cables, ropes, and straps are rated for the winch on which they can be installed. Winch ropes, strap, and cable should have a minimum of four (4) complete wraps around the winch drum in the most extended position for launching or retrieving the boat.

You can depend on Attwood winch straps. They're easy to install and prevent tangling on winch drum. Built to be strong and durable. UV-resistant webbing with a special, heavy-duty, forged steel, snap hook. The extra-long throat is designed for easier attachment to bow eyes on boats. Two strap-end styles are available for easy, secure attachment to the winch drum. Rated for winches up to 2,000 lbs.

Webbing: Polyester webbing is one of the finest web strap materials available. Polyester does not stretch and offers excellent resistance to ultraviolet degradation from sunlight.

Strap-End Styles: Two styles available (1) Cut-End, and (2) Sewn-Loop End.

Hook: Heavy-duty, forged, zinc-plated steel snap hook. Spring-loaded closure for secure attachment. Extra-long throat for easy attachment.



11147-7

Description	Length	OEM Part #	Part #
Sewn-loop end	20 ft.	—	11147-7



11739

Poly Winch Ropes

Twisted polypropylene 3/8 inch diameter winch rope is economical, versatile, and easily spliced. Resistant to rot and mildew and is UV stabilized. For winches rated up to 1,200 lbs., not intended for other uses

Description	Color	OEM Part #	Part #
3/8" x 20' Long	Black	—	11739-2

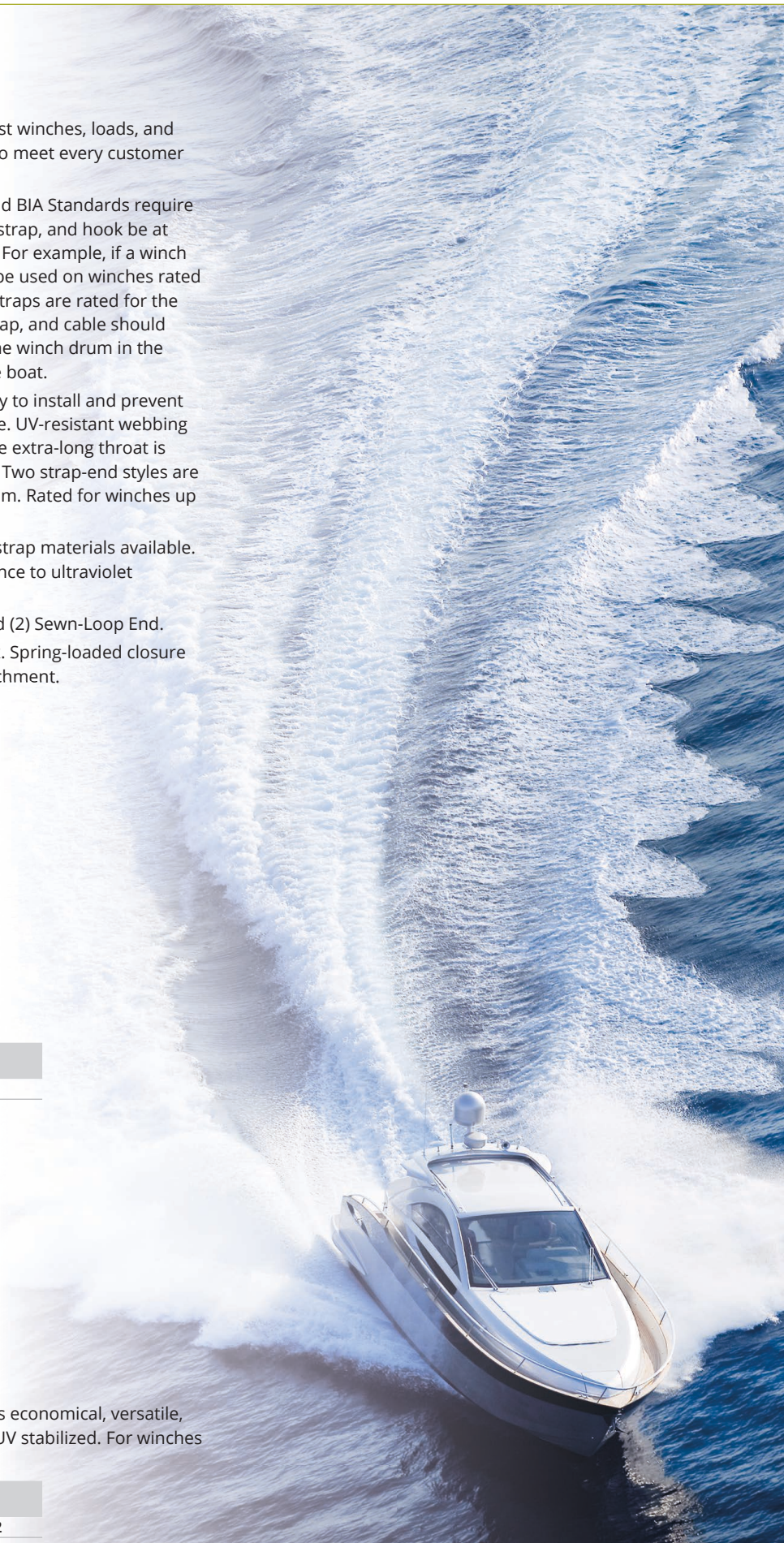

Bow Stops & Rollers

Road-ready bow stops, rollers, and roller brackets provide protective support for your boat's hull while it's on the trailer, and allow easier launching, centering, and retrieval of the boat. This assortment includes rollers, bow stops, and steel roller brackets. Rollers and bow stops are available in polymer or rubber.

Rubber Rollers	Polymer Rollers
Non-marring prime rubber compound	Will not mark or discolor your boat
Economically priced	Resist cuts and abrasions
Original equipment replacements for most trailers	Have superior durability to outlast ordinary rollers



Bow Rollers, Polymer

Non-marring, resilient bow protection. Smooth finish helps boat roll easily into place. Impervious to sunlight, chemicals, and fuels.

Description	Dimensions	Hole I.D.	OEM Part #	Part #
Bow Roller	3" O.D. x 3" L	1/2"	11881-1	—
Bow Roller	4" O.D. x 4" L	1/2"	11880-1	—
Bow Roller w/ Bells	3-1/2" O.D. x 4" L	1/2"	11857-1	—



Spool/Keel Rollers, Polymer

Smooth, non-marring, resilient protection. Impervious to sunlight, chemicals & fuels. Fits 1/2 inch diameter shafts.

Dimensions	Outside Diameter	OEM Part #	Part #
Spool/Keel Roller	4"	11315-1	—
	5"	11317-1	—
Keel Roller	8"	11319-1	—



Bow Stops, Rubber

Molded rubber stops. Each is pre-drilled with 3/8 inch or 1/2 inch diameter hole.

Dimensions	Hole I.D.	OEM Part #	Part #
2" x 2"	3/8"	11200-1	—
3" x 3"	1/2"	11201-1	—
4" x 4"	1/2"	11202-1	—



Bow Rollers, Rubber

Durable protective molded rubber bow rollers.

Description	Outside Diameter	Shaft Diameter	OEM Part #	Part #
3" length	3"	1/2"	11205-1	—
4" length	3-1/2"	1/2"	11209-1	—



Spool/Keel Rollers, Light-Duty Rubber

Durable and protective. Molded rubber with nylon inserts. 3 inch outside diameter.

Dimensions	Shaft Diameter	OEM Part #	Part #
4" length	5/8"	11210-1	—
5-1/4" length	5/8"	11211-1	—



11210

Keel Rollers, Heavy-Duty Rubber

These durable, protective rollers are for heavy-duty use. Molded rubber over a steel tube with nylon end inserts. The gradual inward taper and "V" cut eases loading and launching of heavier boats. Plastic inserts are included to protect from mounting hardware damage.

Dimensions	Shaft Diameter	OEM Part #	Part #
8" length	5/8"	11215-1	—
10" length	5/8"	11216-1	—
12" length	5/8"	11217-1	—

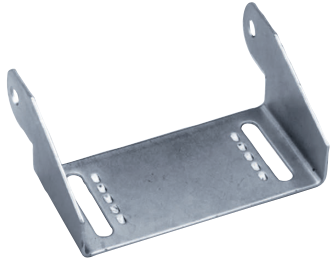

11252

Roller Panel Brackets

Cross-member panel brackets are available for a variety of roller sizes. Long mounting slot allows adjustment. Brackets are pre-drilled with 5/8 inch-diameter holes for roller mount. Zinc-plated or galvanized steel.

Width Between Holes	Slots Size	Width Between Slots	OEM Part #	Part #
4-1/4"	2-1/2"	2-3/8"	11252-1	—
8-1/4"	3"	5-1/2"	11254-1	—



11220

Roller Panel Spool/Keel Bracket Roller Assemblies

Complete spool/keel bracket and roller assembly. Mounts to trailer cross roller assemblies. Formed, zinc-plated steel panel bracket with 1/2 inch-wide slot for adjustment.

Description	Included Parts	OEM Part #	Part #
Spool/keel	11210 roller and 11252 bracket	—	11220-3



11230

Adjusting Rollers, Rubber

For use with automatic adjusting roller systems. Molded rubber. Smooth surface has steel insert; ribbed surface has nylon insert.

- 4-1/4" L x 4-3/8" dia.

Description	Shaft Diameter	OEM Part #	Part #
Smooth	3/4"	11230-1	—



11363

Bunk Brackets

For mounting bunks. Slotted for vertical adjustments. Mounts with 1/2 inch (1.27 cm) bolt. 11-gauge galvanized steel.

Length	Width	OEM #	Part #
8"	2"	11363-1	—
10"	2"	11364-1	—



11360

Swivel Bolster Brackets

Heavy 11-gauge galvanized steel that is slotted for vertical adjustment. Non slip dimples for secure hold. 3.5 inch wide angle bracket pivots for angled or flat mounting of 2 inch x 6 inch bunk or bolster boards. Complete with nut and bolt for angle bracket. Mounts with 1/2 inch bolt.

Size	Assembled	OEM #	Part #
8"	9"	11360-1	—
10"	11"	11361-1	—
12"	13"	11362-1	—

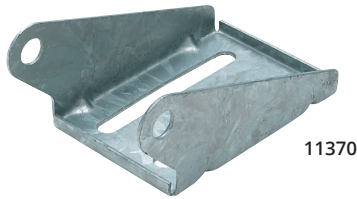

11370

Keel Mounting Bracket

One piece roller bracket with 5 inch slot for vertical adjustment. Mounts with 1/2 inch bolt and is designed to be used with a 5/8 inch roller shaft.

Size	Slot Center	OEM Part #	Part #
5"	2-3/4"	11370-1	—
10"	8-3/16"	11371-1	—
12"	10-1/8"	11372-1	—



11282

Roller Shaft Sets

Roller shafts and matching pal nuts secure shaft in place on roller. Shaft and nuts are solid zinc-plated steel.

Description	Length	Roller Size	OEM Part #	Part #
5/8" dia.	6-3/8"	5-1/4"	—	11282-3
	9-1/4"	8"	—	11283-3
	11-1/4"	10"	—	11284-3
	13-1/2"	12"	—	11285-3



11368

Pal Nuts

5/8 inch zinc plated pal nuts to be used with 5/8 inch roller shafts.

Description	OEM Part #	Part #
Set of 8	—	11368-3



11246

Trailer Bunk Padding

12 ft. long roll of durable, weather-resistant polypropylene marine carpet material. Easy to cut and custom fit. Protects hull; eases loading and launching. Charcoal color; acrylic backing grips surface of trailer bunk boards or cradle. No excessive fuzz, static-free. Made for minimal water retention.

Description	OEM Part #	Part #
8" wide	—	11246-1
12" wide	—	11247-1

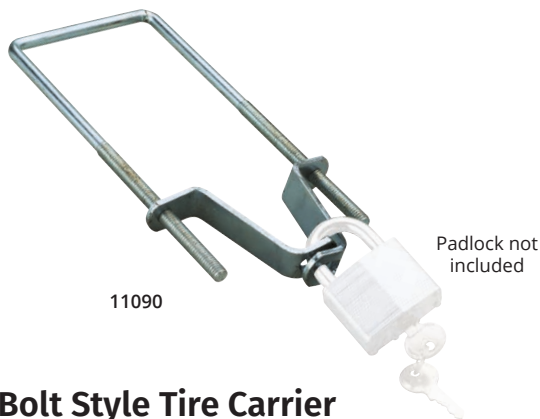

11090

Padlock not included

U-Bolt Style Tire Carrier

Square-bend U-bolt with bracket mounts tire on tongue or trailer frame. The frame must be between 2 inch x 2 inch square to 3-1/2 inch x 4 inch rectangular in size. Fits 4- or 5-lug hole rims. Extra-long 8-1/2 inch shaft fits 8 inch to 15 inch tires.

Description	OEM Part #	Part #
Zinc-plated steel	—	11090-3

Transom Savers

We've got you covered

A lifted outboard puts hundreds of foot-pounds of pressure on the transom, especially during trailering.

Protect your boat and engine

- Support the cantilevered weight of the motor
- Stabilize engine and steering mechanism when trailering

The Attwood Difference

- Tough components — You'll get long life from our adjustable toggles with replaceable rubber pads
- Innovation — Our shock absorbing spring-loaded transom saver, is designed to reduce damaging effects of road shock. Works great for motors with hydraulic trim/tilt

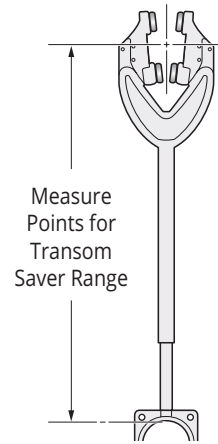

Composite Head



Heavy-Duty Head



Roller Bracket



Trailer Mount Bracket

All Aftermarket parts include both the Roller and Trailer Mount brackets

Description	Head Type	Mounting Bracket	OEM Part #	Part #
Adjustable Transom Savers				
23"-35"	Composite	Roller	400-R	—
		Trailer Mount	400-B	—
		Roller/Trailer Mount	—	SP-400-RB
Heavy Duty Transom Savers				
24"-36"	Heavy Duty	Roller	4000-ADJ	—
		Trailer Mount	4000-ADJ-B	—
		Roller/Trailer Mount	—	SP-4000-ADJ-RB
32"-44"	Heavy Duty	Roller	424-ADJ	—
		Roller/Trailer Mount	—	SP-424-ADJ-RB
44"-56"	Heavy Duty	Roller	436-ADJ	—
		Roller/Trailer Mount	—	SP-436-ADJ-RB
Shock Absorbing Transom Savers				
27"-36"	Heavy Duty	Roller/Trailer Mount	—	SP-421-RB
31"-40"	Heavy Duty	Roller/Trailer Mount	—	SP-429-RB
Replacement Parts				
Bolt on Bracket for Attwood Transom Savers			—	SP-402
Replacement Rubber Shocks for Heavy-Duty Head			—	SP-410
Replacement Toggle for Heavy-Duty Head			—	SP-416



SP-400-RB



SP-4000-ADJ-RB



SP-421-RB

Shock Absorbing Spring

Adjustable Transom Saver

Innovative design fits most trailers. Unique angle adjustment (patent pending) from 0 inch to 36 inch with 12 inch increments. Heavy-duty rubber pads and steel construction. Corrosion-resistant, black finish.

Description	Head Type	Mounting Bracket	OEM Part #	Part #
36"-60"	Heavy Duty	Trailer Mount	460-ADJ	—



Lock N' Stow

- Locks outboard motor in forward position while trailering, greatly reducing the damaging effects of road shock
- Doesn't tie engine's lower-unit to trailer, eliminating excessive pressure on hydraulic seals and scuff marks
- Small compact mount can be easily stored in just about any boat compartment
- Constructed of black powder-coated steel with stainless steel pins

Fits:	OEM Part #	Part #
OMC, Bombardier 1989 to present, 100HP and up	—	10309
Mercury engines 200 OptiMax, 255 OptiMax, 225HP EFI, 250HP EFI	—	10107
Mercury engines 135 OptiMax, 150 OptiMax 175 OptiMax, 75HP-200HP EFI	—	10108



Tie-Down Straps

Quick-Release Transom Tie-Down Straps

When properly secured to transom eyes and trailer, transom straps reduce vertical and lateral movement to safely secure the boat to the trailer. They also reduce bouncing of the boat on the trailer pads or rollers. Available in 2 inch width for larger trailerable boats and 1 inch width for lighter boats.

Webbing: Strong webbing. Resists rot, oils, gasoline, and most chemicals.

Buckle: Quick-Release (Over-Center) buckle. Strong and secure, yet easy to use. Quicktightening. Cinch tight and secure by depressing buckle handle. Release by lifting the buckle handle.

Hook: Vinyl-Coated S-Hook to prevent scratching boat or trailer finish. Corrosion-resistant. Heavy-gauge.

Special Features: Protective pad behind buckle to prevent marring and scratches on gel coat and painted surfaces. Hook-N-Loop closure secures the buckle handle in the locked position.

Description	Width	Length	OEM Part #	Part #
One pair	2"	4 ft.	—	15232-7



Quick-Release Gunwale Straps

Gunwale straps secure the entire aft section of the boat over the gunwale to the trailer and restrict vertical movement while on the road.

Webbing: Strong webbing. Resists rot, oils, gasoline, and most chemicals.

Buckle: Quick-Release (Over-Center) buckle. Strong and secure, yet easy to use. Quick tightening. Cinch tight and secure by depressing buckle handle. Release by lifting the buckle handle.

Hook: J-Hook with snap-closure for secure, easy attachment. Electrostatic Discharge Coating (EDC) finish to prevent corrosion. Heavy gauge.

Description	Length	OEM Part #	Part #
2" Wide	13 ft.	—	15221-7



HARDWARE

Cleats



156

Attwood provides a variety of durable and attractive cleat options to fit all your docking needs. Select from various finishes that are in tune with styling of today's boats.

Lift Rings, Hawse Pipes & Bow Eyes



161

Lift rings provide heavy duty strength for boats lifted by davits, cranes, or shore stations. Attwood hawse pipes reduce deck and rope chafing when attaching dock lines to cleats. Bow eyes can function as a ski tow when transom-mounted.

Hooks



163

Links, carabines, and hooks are fundamental in boating, providing security and multi-use functionality.

Water Ski Hardware

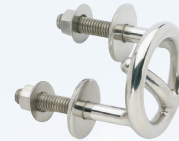

164

Attwood water ski hardware is ideal for PWCs, I/Os, and inboard ski boats. Constructed of 304 stainless steel for corrosion resistance, smoothed and highly polished for a clean design.



HARDWARE

Bimini Style Convertible Top Accessories



166

For a complete support system, our bimini top fittings offer substantial protection and security.

Hinges



167

Attwood hinges provide the support and stability needed for a smooth operation of your vessel.

Hatch & Door Hardware



169

Secure locking closures stabilize gates, lids, doors, compartments, and hatches to prevent inward swinging.

Hand Rails & Handles



171

Streamlined, strong, and shaped to fit on runabouts, fishing boats, jet boats, and RVs.

Gas Springs & Mounting Brackets



172

Attwood offers a wide selection of gas springs, made with bio-degradable no hazard to water grade oil, making them the marine industry's most environmentally friendly gas springs.

Cleats



Neat Cleat

The Neat Cleat design offers what you've been asking for — a retractable cleat with a thin profile that installs easily on narrow gunwales.

- Beautiful, strong and durable – each stanchion is a 7/8" rod of solid Enhanced 316 Stainless Steel alloy
- Cleats stay up when pulled
- Backed by a lifetime warranty against corrosion

Installation is simple and quick – just drill twice with an appropriate size hole saw. Drainage chargers (included) capture moisture and send it to the bilge via pitot tubing (not included). Attwood recommends using only stainless steel fasteners for stainless steel hardware.

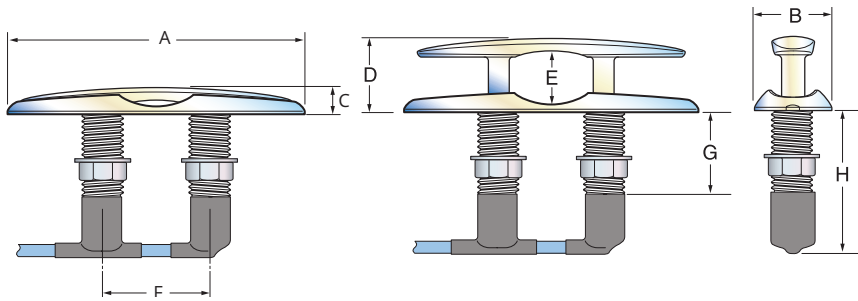
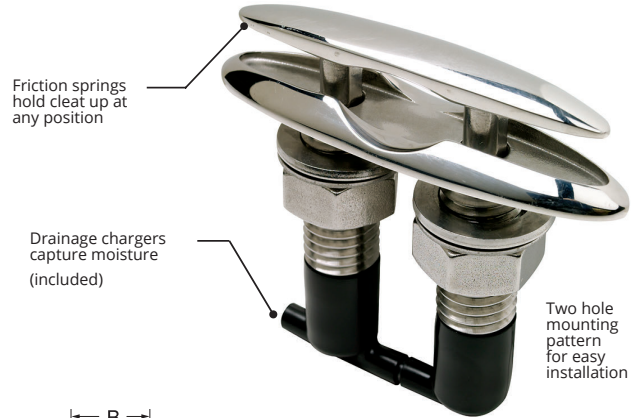

A	B	C	D	E	F	G	H	Installation			
Total Length	Total Width	Above Deck Lowered	Above Deck Raised	Line Opening	Between Stanchions	Thread Length	Install. Depth	Hole Saw Size	Max. Hull Thickness	OEM Part #	Part #
4-1/2"	1-5/16"	1/2"	1-5/8"	1-1/4"	1-3/4"	1-3/4"	3-1/8"	1"	1"	66515-1	66515-7
6"	1-1/2"	1/2"	1-5/8"	1-1/4"	2-1/4"	1-3/4"	3-1/8"	1"	1"	66517-1	66517-7
8"	1-15/16"	3/4"	2"	1-3/8"	2-13/16"	2-1/4"	3-3/4"	1"	1-1/2"	66519-1	—
10"	2-7/16"	13/16"	2-5/8"	1-5/8"	3-1/2"	2-7/8"	5-1/4"	1"	1-1/2"	66538-1	—

Neat Cleat Accessories

Description	OEM Part #	Part #
Backing Plates		
For 4-1/2" Neat Cleat	66529-1	—
For 6" Neat Cleat or Combo Cleat	66531-1	—
For 8" Neat Cleat or Combo Cleat	66533-1	—
Spacers		
For 6" Neat Cleat or Combo Cleat	66617-1	—

For our Stainless Steel Thru-Hulls and Scuppers see Pages 28-30.



Flush Cleats

This cleat recesses flush to the deck for a clean, contemporary look at an affordable price. Two mounting styles include an exclusive stud-mounted cleat (patented). Water-resistant cleat recesses into cast body, and is captured with lubricated seals. Durable, enhanced cast 316 Stainless Steel construction and simple design assures long-life and dependable operation.

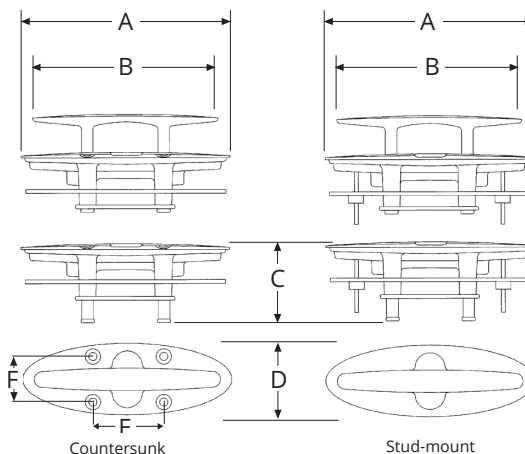

66510



66512

Easy Installation

- Includes backing plate
- Enhanced 316 Stainless Steel Alloy

Description	A	B	C	D	E	F	Fastener Quantity	OEM Part #	Part #
Countersunk*									
4-1/2" Cleat	5-1/4"	4-1/2"	3-1/8"	2"	1-5/8"	1-7/16"	(4) #10	66510-1	66510-7
6" Cleat	7"	6"	3-1/3"	2"	1-7/8"	1-21/32"	(4) 1/4"	66514-1	66514-7
8" Cleat	8-1/2"	7-3/4"	3-7/8"	2-13/16"	3-1/2"	2-1/8"	(4) 1/4"	66522-1	—
Stud-Mount*									
4-1/2" Cleat	5-1/4"	4-1/2"	3-1/8"	2"	—	—	—	66512-1	—
6" Cleat	7"	6"	3-1/3"	2-3/8"	—	—	—	66516-1	66516-7
8" Cleat	8-1/2"	7-3/4"	3-7/8"	2-13/16"	—	—	—	66524-1	—

* Countersunk models: Fasteners not included. Stud mount: Fasteners are included.



Folding Cleat

This Enhanced 316 Stainless Steel construction folding cleat locks down to the flush position when not in use, or easily flips up and locks in place when needed. Contemporary look for an economical price. Available with (flush-mount) and without (stud mount) visible holes for mounting.



66586



66588

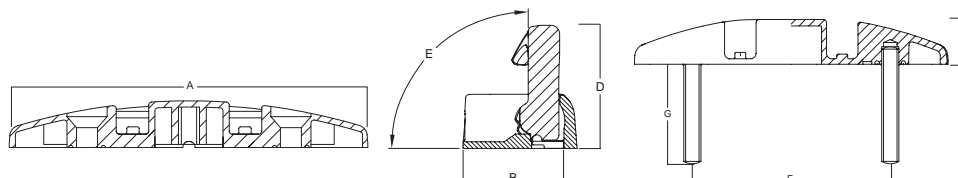

Description	A	B	C	D	E	F	G	Fasteners Included	OEM Part #	Part #
Flush Mount										
4-1/2" Cleat	4-3/5"	1-1/10"	3/5"	1-1/2"	90°	2-5/8"	—	No	66586-1	—
Stud Mount										
4-1/2" Cleat	4-3/5"	1-1/10"	3/5"	1-1/2"	90°	2-5/8"	1-11/16"	Yes	66588-1	—
6" Cleat	5-7/10"	1-3/5"	4/5"	1-17/20"	90°	3-3/5"	1-4/5"	Yes	66589-1	—

Whitley Cleats

The innovative Whitley Cleat is an Attwood exclusive! The unique, offset design is inspired by contemporary Euro styles. Yet, for all its good looks, this sturdy cleat exceeds ABYC strength standards!

- Polished stainless finish provides an attractive, premium appearance for the finest boats
- Alloy is certified Enhanced 316 Stainless Steel. Acid and rinsing baths remove surface contaminants and produce a mirror-finish hydrous oxide film. Backed by a Lifetime Warranty against corrosion
- Stud mounting leaves no exposed fasteners to collect water or dirt
- Stainless steel locking nuts and washers are supplied to fit the concealed stainless steel studs

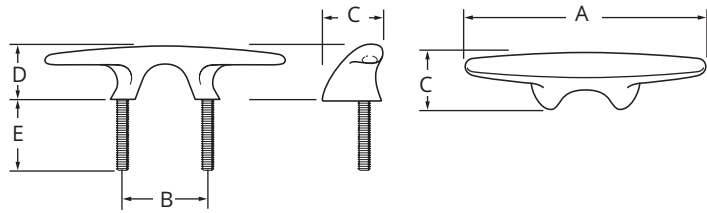

Description	A	B	C	D	E	Stud Size	OEM Part #	Part #
6-1/2" long	6-1/2"	2-13/16"	1-1/2"	1-1/2"	2"	5/16" x 18	66062-1	—
8-1/2" long	8-1/2"	2-15/16"	2"	1-7/8"	2-1/2"	3/8" x 16	66063-1	—
10-1/2" long	10-1/2"	3-3/16"	2-15/16"	2-3/16"	3"	7/16" x 14	66064-1	—



Contemporary Cleats

These beautiful cleats have a modern look and are priced to compete. The clean lines and well-defined surfaces are in tune with styling of today's boats. Thick stanchions offer hearty appearance and performance. Enhanced 316 Stainless Steel alloy. Guaranteed for life. Stainless locking nuts and washers included.

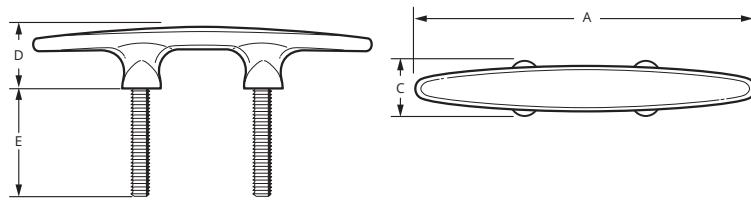

Description	A	B	C	D	E	Stud Size	OEM Part #	Part #
6" long	6"	2-1/4"	1"	1-3/16"	2"	5/16" x 18	66054-1	—
8" long	8"	2-13/16"	1-15/16"	1-3/8"	2-1/2"	7/16" x 14	66055-1	—
10" long	10"	3-5/8"	1-11/16"	1-13/16"	3"	7/16" x 14	66056-1	—



66054

Stud Mount Herreshoff Cleat

This cleat features the classic look of a traditional Herreshoff design plus all the advantages of a stud mount installation. Enhanced 316 Stainless Steel alloy. Guaranteed for life. Stainless locking nuts and washers included.

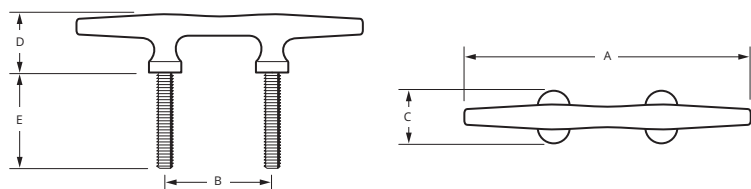

Description	A	B	C	D	E	Stud Size	OEM Part #	Part #
4" long	4"	1-3/16"	9/16"	1"	1-1/4"	1/4" x 20	66334-1	—
6" long	6"	2-1/4"	7/8"	1-1/4"	1-3/4"	1/4" x 20	66335-1	—
8" long	8"	2-7/8"	1-3/16"	1-1/2"	2"	5/16" x 18	66336-1	—



66336

Herreshoff Cleats

Classic Herreshoff style cleat provides traditional styling, easy line tie-off, and corrosion resistance. Made of Enhanced 316 Stainless Steel alloy. Four holes for required fasteners.

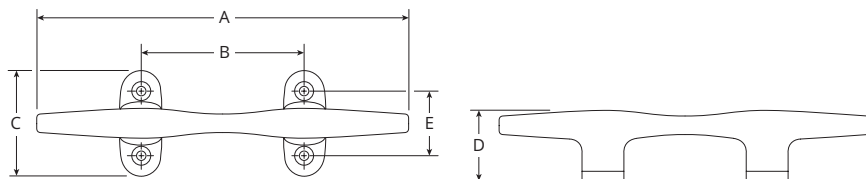

66398

Description	A	B	C	D	E	Fastener Quantity	OEM Part #	Part #
5" long	5"	2-9/64"	1-1/2"	1-1/8"	1"	(4) #10	66398-1	—
6" long	6"	2-1/4"	1-7/8"	1-1/4"	1-9/64"	(4) 1/4"	66009-1	66009L6
8" long	8"	2-27/32"	2-3/16"	1-1/2"	1-11/32"	(4) 1/4"	66010-1	66010L3
10" long	10"	3-3/4"	2-11/16"	1-7/8"	11-1/16"	(4) 5/16"	66011-1	66011-3
12" long	12"	3-7/8"	2-3/4"	2-3/16"	1-15/16"	(4) 5/16"	66012-1	—

Heavy-Duty Herreshoff Cleats

This heavy-duty Herreshoff is a wider, taller, and heavier version of the standard Herreshoff cleat. Made of Enhanced 316 Stainless Steel alloy. Four holes for required fasteners.

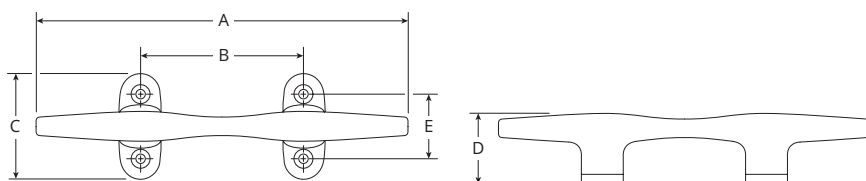

66110

Description	A	B	C	D	E	Fastener Quantity	OEM Part #	Part #
8" long	8"	2-9/64"	1-1/2"	1-1/8"	1"	(4) #10	66110-1	66110-3
10" long	10"	2-1/4"	1-7/8"	1-1/4"	1-9/64"	(4) 1/4"	66111-1	66111-3
12" long	12"	2-27/32"	2-3/16"	1-1/2"	1-11/32"	(4) 1/4"	66112-1	—

Fender Cleat

Stainless steel. Easily secure fenders to your boat with a simple lift of this retractable cleat. Durable, enhanced cast 316 Stainless Steel construction and simple design assures long life and dependable operation. Small 3-1/2" design.

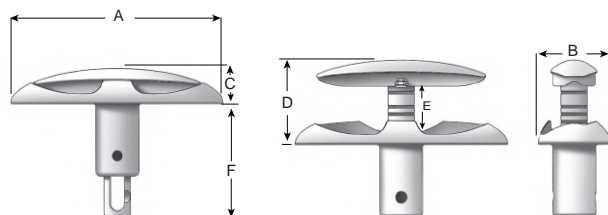

66502



A	B	C	D	E	F	Hole Distance	OEM Part #	Part #
Total Length	Total Width	Above Deck Lowered	Above Deck Raised	Max. Line Opening	Install. Depth			
3-1/2"	1-3/16"	9/16"	1-3/8"	3/4"	1-7/8"	1-11/16"	66502-1	—

(Not for use for mooring, towing or lifting.)

Chrome-Plated Zinc Cleats

These studded cleats have a modern look and are priced to compete. The clean lines and well-defined surfaces are in tune with styling of today's boats. Thick stanchions offer hearty appearance and performance.

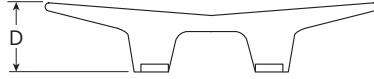
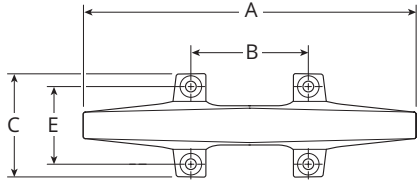

12022

Description	A	B	C	D	E	Fastener Quantity	OEM Part #	Part #
4-1/2" long	4-1/2"	1-11/16"	1-5/8"	1-1/16"	1-3/16"	(4) #8	6244-1	6244-6, pair
6" long	6"	2-7/32"	2-3/32"	1-11/32"	1-1/2"	(4) #10	6245-1	12009-3 6245-6, pair

Cast Aluminum Cleats

Cast aluminum cleats, available in 4 popular sizes. Ideal for small boats and docks. Two holes for required fasteners.

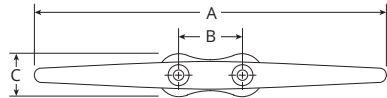

12120

Description	A	B	C	D	Fastener Quantity	OEM Part #	Part #
4-1/2" long, closed base	4-1/2"	2-7/32"	3/4"	1-1/2"	(2) 1/4"	12120-1	12121-3
6" long, closed base	6"	1-3/8"	7/8"	1-13/32"	(2) 1/4"	12124-1	12125-3
8" long, open base	8"	1-1/2"	1-1/16"	1-3/4"	(2) 1/4"	12126-1	12127-3

Cast Iron Cleats

Cast iron dock cleat with galvanized finish, available in 2 popular sizes. Two holes for required fasteners.

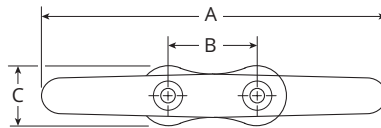
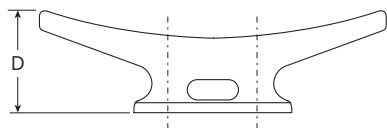

12100

Description	A	B	C	D	Fastener Quantity	OEM Part #	Part #
6" long	6"	1-3/8"	7/8"	1-3/16"	(2) 1/4"	—	12100L3
8" long	8"	1-7/8"	1-1/8"	1-5/8"	(2) 3/8"	12102-1	12102L3

Nylon Cleats

Corrosion-resistant light weight cleats. Two holes for required fasteners.

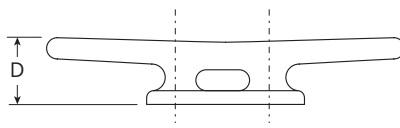
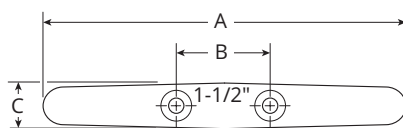

12110

Description	A	B	C	D	Fastener Quantity	OEM Part #	Part #
5" long	5-1/16"	1-29/64"	23/32"	1-1/64"	(2) #12	12110-1	12111L3
6-1/2" long	6-13/32"	1-21/32"	13/16"	1-7/32"	(2) #12	12112-1	12113L3
8" long	7-15/16"	1-51/64"	15/16"	1-3/8"	(2) 1/4"	12114-1	12115L3

Lift Rings



Stainless Steel Lift Ring

Attwood's stern-mounted lift ring provides heavy-duty strength for boats lifted by davits, cranes or shore stations. Lifts a maximum vertical load of 12,000 lbs. Installs with 1/2" countersunk stainless steel screws and washers, which must be through-bolted with locking washers or locking nuts.

Warning: Lift rings are designed to lift a boat only when fastened to the boat structure. The maximum lifting load figures listed were determined by applying a test load in the direction of the eye shank axis, with the shank fixed in an immovable testing device. Listed lifting loads are for reference only.

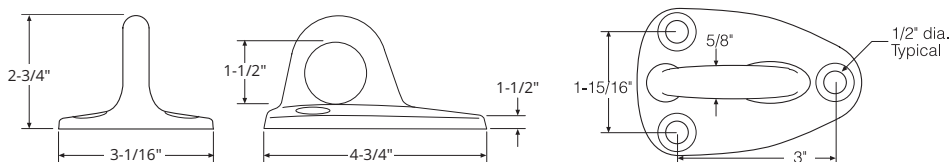

66120

Description	OEM Part #	Part #
Stainless steel lift ring	66120-1	—

Large Flush Lift Ring, Brass

Large lifting ring allows a full grip. Provides strength for lifting large and heavy hatch covers. Flush appearance, neatly recessed for safety. Chrome-plated brass. Pre-drilled with four holes for #6 fasteners.

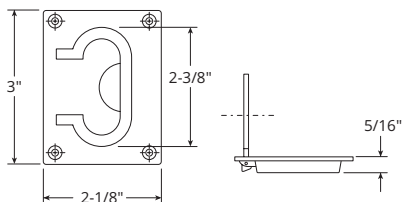

3325

Description	Flange Size	Handle Size	Fastener Quantity	OEM Part #	Part #
Brass	3" L x 2-1/4" W	2" L x 3/4" I.D. ring	(4) #6	—	3325-3

Hawse Pipes & Bow Eyes



Enhanced 316 Stainless Steel alloy Hawse Pipes reduce deck and rope chafing when attaching dock lines to cleats mounted inside the cockpit. Available in a variety of shapes and sizes for different installation locations.

Double-Sided Oval Hawse Pipe

Enhanced 316 Stainless Steel alloy Hawse Pipe. Two-piece construction provides a finished appearance for cock-pit and gunwale installation. For 1-1/2" minimum deck thickness.

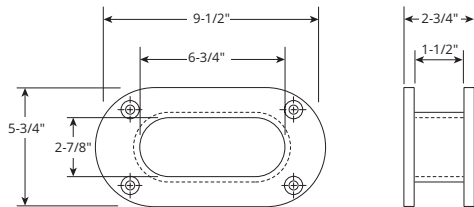

66224

Description	Fastener Quantity	OEM Part #	Part #
Opening Size: 6-3/4" L x 2-7/8" W	(4) #10	66224-1	—

Oval Hawse Pipes

Our most popular-sized Hawse Pipes. Available in two opening and flange sizes to fit your installation. Four holes for required #10 fasteners. Enhanced 316 Stainless Steel alloy.

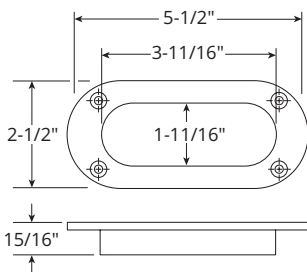

66223

Description	Fastener Quantity	OEM Part #	Part #
Opening Size: 3-11/16" L x 1-11/16" W	(4) #10	66223-1	66223-3

Rope/Deck Pipe

Use as an access lid to anchor chain and rope storage lockers. Cover is hinged and spring-loaded to stay shut without rattling. Cover can be locked in open position. Enhanced 316 Stainless Steel alloy.

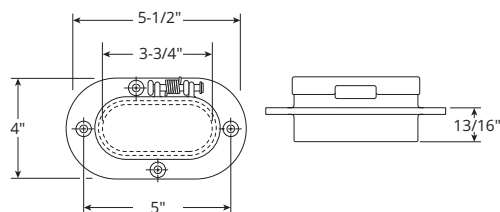

66008

Description	Installation Hole Size	Fastener Quantity	OEM Part #	Part #
Opening Size: 3-3/4" x 2-3/8"	4-1/8" long x 2-3/4" oval	(4) #10	66008-1	—

Bow Eyes, Stainless Steel

Bow eyes have twin shanks to prevent twisting. These rugged bow eyes, when transom-mounted can function as a ski tow.

Not to be used for lifting.

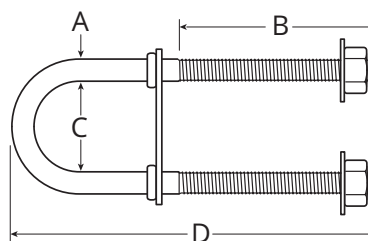

A	B	C	D	Face Plate Dimensions	Pull Strength (lbs.)	OEM Part #	Part #
With Plated Nuts and Washers							
5/16"-dia.	3/8"-16 x 2-7/16"	1-1/16"	4-3/8"	2-1/2" x 9/16"	6,000	3396-1	3396-3
7/16"-dia.	1/2"-13 x 3-1/4"	1-9/16"	5-5/8"	2-3/4" x 3/4"	12,000	3392-1	3392-3
With Stainless Steel Nuts and Washers							
5/16"-dia.	3/8"-16 x 2-7/16"	1-1/16"	4-3/8"	2-1/2" x 9/16"	6,000	66263-1	—
7/16"-dia.	1/2"-13 x 3-1/4"	1-9/16"	5-5/8"	2-3/4" x 3/4"	12,000	66261-1	66261L3
7/16"-dia.	1/2"-13 x 3-1/4"	1-9/16"	5-5/8"	3-1/2" x 1-3/4"	12,000	66262-1	—

Hooks

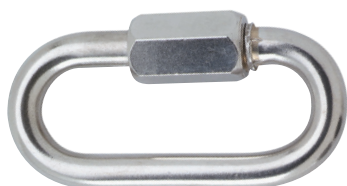

12891

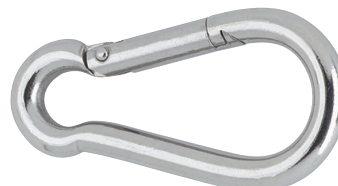

12415

Chain Link

For easy connection of anchor rope thimbles to anchor chain. Available in rugged stainless steel or zinc-plated steel construction material.

Description	Diameter	Length	Maximum Safe Load ∇	OEM Part #	Part #
Stainless Steel	5/16"	2-7/8"	3,000 lbs.	—	12891L3
Zinc-Plated Steel	7/32"	2-1/4"	1,000 lbs.	—	12355-3
	5/16"	3"	2,000 lbs.	—	12357-3

Marine Carabiner

Spring-loaded closure.

Description	Length	Ring Diameter	Maximum Safe Load ∇	OEM Part #	Part #
Stainless Steel	2-1/2"	1/4"	350 lbs.	12412-1	—
	3-1/8"	5/16"	575 lbs.	—	12415L3
Zinc-Plated Steel	2-1/2"	1/4"	300 lbs.	—	12303-3
	3-1/2"	3/8"	600 lbs.	—	12305-3
	3-1/8"	5/16"	700 lbs.	—	7651-3



7653

7640

Utility Snap Hook

Zinc-plated steel with spring-loaded closures.

Description	Length	Ring Diameter	Maximum Safe Load ∇	OEM Part #	Part #
Light-duty	4"	1/4"	500 lbs.	—	7653L3
Heavy-duty	4"	5/8"	2,500 lbs.	—	7640-3



9146

Clamp-On Oarlocks

Zinc-plated steel resists rust. Oarlock fastens securely to oar with one adjustable bolt, no drilling required.

Description	OEM Part #	Part #
Shank 1/2"-dia. x 2"	—	9146-3

∇ Maximum safe load is approximately half of maximum load or break strength. Do not exceed maximum safe load. Do not use in applications where life or limb is at risk.

Water Ski Hardware

Flush Mount Ski Tow

This Enhanced 316 Stainless Steel alloy Ski Tow mounts flush to the transom and has no exposed fasteners. Offers a clean look and prevents snags. The elliptical hook accepts up to 5/8" tow line, but rises only 1/2" outward and blends perfectly with the circular body. Easy to install by drilling one 2-1/8" diameter hole with a hole saw. The wide flange covers a bead of sealant and large aluminum backing plate provides solid holding. Backing plate and stainless locking nuts included. Exceeds American Water Ski Association standards for strength. Patented. Backed by a limited lifetime warranty against corrosion.

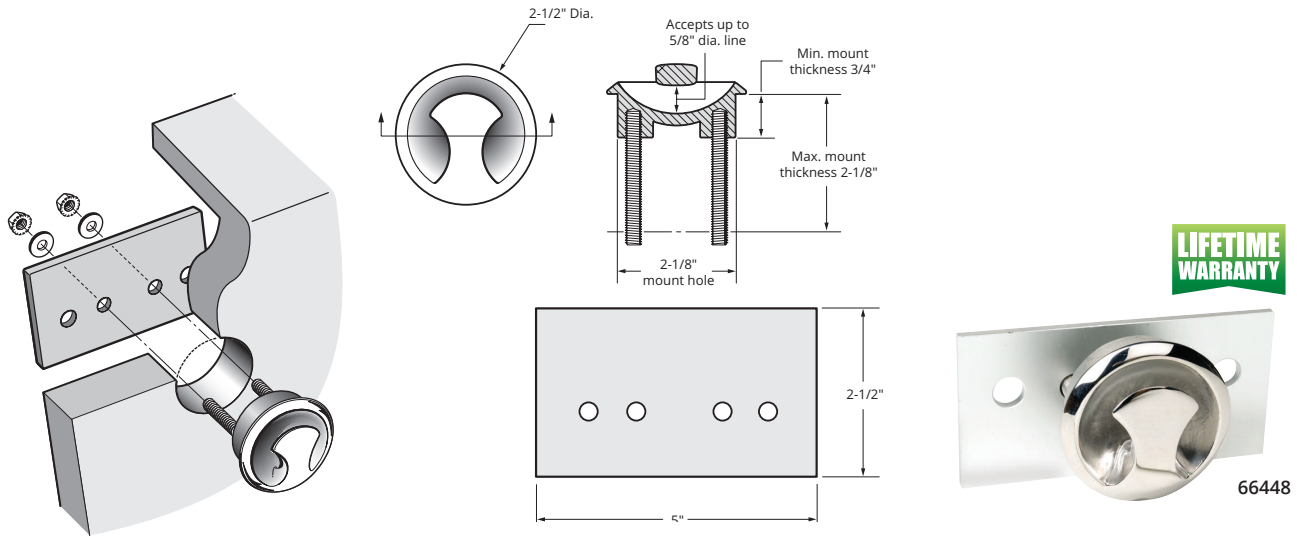

Description	OEM Part #	Part #
Stainless Ski Tow with 2-1/2" x 5" backing plate	66448-1	—

Ski Tows

Constructed of 304 Stainless Steel for corrosion-resistance, these tows are ideal for PWC's, I/O's, and inboard ski boats. All welded seams are smoothed and the surface has a highly polished finish. Stainless steel mounting washers and nuts included. A wide, welded-on mounting ring meets the hull so no exterior mounting plate is needed. Exceeds American Water Ski Association standards.

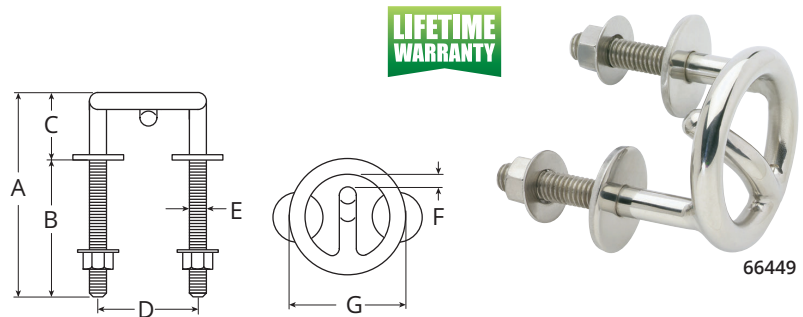

Ring Diameter	A	B	C	D	E	F	G	OEM Part #	Part #
2-1/2", short shank	2-7/8"	1-1/2"	1-5/16"	2-1/8"	3/8"	3/8"	2-1/2"	66449-1	—

Ski Pylons

The Attwood Difference

- Our heavy duty tow products will pull you anywhere you want to go
- We offer a wide range of configurations for swivel heads, posts, and bases
- Our towing products offer advanced features for durability and quality performance
- The Pro-Swivel has a 360° rotational head with a nylon bushing for smooth slalom pulling

DO NOT use Ski Pylons to pull any recreational equipment that is tied to the tow rope such as water tubes, aquaplanes, wakeboards, etc.



Description	Post Dia.	Post Height	Post Base	Arm Dia.	Arm Length	Arm Base	OEM Part #	Part #
Fixed Height								
Stainless Steel	1-1/4"	36"	2' x 4" Below Deck	1"	33"-56"	Perm. Thru Deck	9436-S	—
	1-1/4"	43"	2' x 4" Below Deck	1"	33"-56"	Perm. Thru Deck	9433-S	—
	2"	45"	6" Dia. SS	1"	33"-56"	Rem. Clev. Pin	923-009	—
	1-1/2"	23"	2' x 4" SS Base	1"	33"-56"	Rem. Clev. Pin	922-ADJ-S	—
		29"	3/4" Pin Base	1"	33"-56"	Rem. Clev. Pin	903-008-T-S	—
		45"	6" Dia. SS	1"	33"-56"	Rem. Clev. Pin	903-009-S	—
Adjustable Height								
Stainless Steel	2"	34"-58"	6" Dia. SS	1"	33"-56"	Rem. Clev. Pin	923-009-ADJ	SP-923-009-ADJ
	1"	28"-33"	Nylon Flush Mount	1"	33"-56"	Nylon Flush Mount	96008	SP-96008
		35"-52"	Nylon Flush Mount	1"	33"-56"	Nylon Flush Mount	—	SP-96009

Ski Pylon Replacement Parts

Description	OEM Part #	Part #
Threaded Base, Polished Stainless Steel, 6" Diameter	—	952
Deck Clevis, Set	—	SP-910



Stainless Steel Base
952



Deck Clevis Set
SP-910

Bimini Style Convertible Top Accessories

Deck Hinges

These deck hinges feature a flat base for deck mounting and have two holes for #10 fasteners. Enhanced 316 Stainless Steel alloy for corrosion-resistant support system of bimini tops. Stainless steel pin is springloaded for easy top removal.



66104

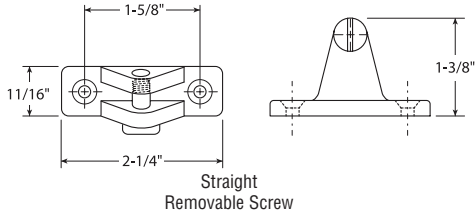

Description	Base Dimensions	Fastens to Bimini Bow Top Cap with:	OEM Part #	Part #
Straight base	2-1/4" x 11/16"	1/4"-20 removable screw	66104-1	—

Tethered 1/4" Spring-Loaded Clevis Pin

For use with Attwood deck or rail mounted bimini top hinge fittings that use removable 1/4" spring-loaded clevis pins. This handy 1/4" spring-loaded clevis pin with lanyard allows the pin to be tethered to prevent loss of the pin when removed from the bimini top deck or rail hinge fitting.

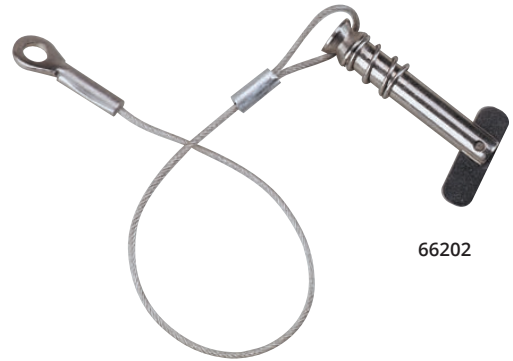

66202

Description	Use With Attwood Deck or Rail Hinge	OEM Part #	Part #
Removeable tethered 1/4" Spring-loaded clevis pin	66160, 66200 66220, 66383	—	66202-3

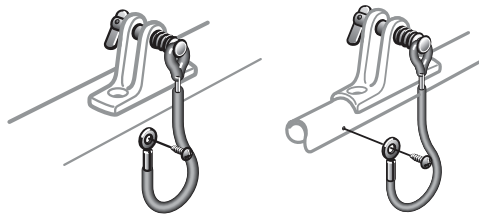

Eye Straps

All eye straps are pre-drilled with two mounting holes.

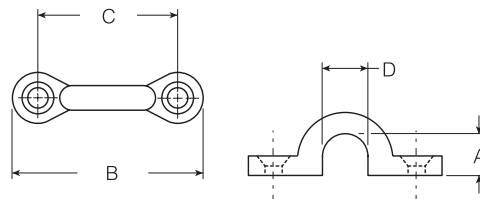

Description	A	B	C	D	Fastener Quantity	OEM Part #	Part #
Cast Stainless Steel	3/8"-diameter	1-7/8" long	1-3/8"	1/2"	#10 fasteners (2)	66105-1	—
Chromed bronze	5/16"-diameter,	1-7/8" long	1-3/8"	1/2"	#10 fasteners (2)	12988-1	—

Hinges

Cast Stainless Steel Hinges

These hinges are cast from enhanced 316 stainless steel. They combine a great eurostyle look with a polished finish. Available in stud or countersunk mounting styles, these hinges look attractive on any vessel! Hinges are mirror polished to the highest specification in the industry and passivated to enhance surface finish and corrosion-resistance. The hinge pin design allows lid to open a full 180°.



Round Hinge, Cast Stainless Steel

Smooth, full round plate design.

Description	Fastener Quantity	OEM Part #	Part #
Counter-sunk	#12 fasteners (4)	66240-1	—

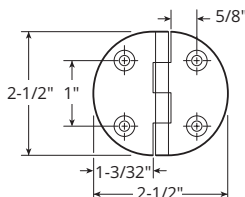

66240

Flush Hinges

The unique double stud design of these hinges allows for a flush installation while still providing a full 180° swing. This makes them the perfect hinge for lazzerette or fish box covers in the cockpit sole.

Flush Hinge, Square End, Stamped Stainless Steel

Square end 2-pin hinge with radiused corners. Six holes for required fasteners. Made of solid stamped stainless steel to provide years of maintenance free service.

Description	Fastener Quantity	OEM Part #	Part #
Counter-sunk	#8 fasteners (6)	66239-1	66239-3

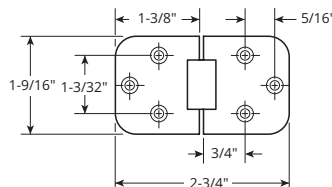

66239

Strap Hinges, Cast Stainless Steel

Durable stainless steel strap hinges, available in standard or reverse strap styles.

Description	Strap Type	Dimensions	Fastener Quantity	OEM Part #	Part #
Four holes	Standard	4" W x 1" L	#10 screws	66025-1	—
	Reversed	4-1/8" W x 1-1/16" W	#10 screws	66434-1	—

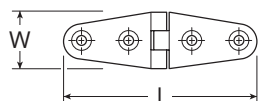

66025



66434

Butt Hinge, Stainless Steel

Strap hinge design with rounded ends.

Description	Fastener Quantity	Dimensions	OEM Part #	Part #
Cast Stainless Steel	#10 fasteners (4)	1-1/2" x 1-1/2"	66163-1	—



66163

Door Hinges, Stainless Steel

Durable cast stainless steel door hinges, available in a variety of lengths. Pair included.

Description	Dimensions	Fastener Quantity [∞]	OEM Part #	Part #
Six holes	3" L x 1-1/2" W	#10 fasteners	66028-1	—
	4" L x 1-1/2" W	#10 fasteners	66029-1	66029-3

[∞]Pin on top

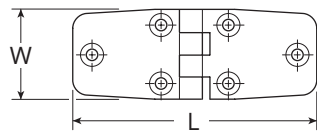

66028



66029

Take-Apart Motor Box Hinge, Non-Locking

For use on motor box or hatch cover. Take apart feature allows removal of cover for engine service or bilge access.

Description	Open Size	Fastener Quantity	OEM Part #	Part #
Brass	4" x 2"	#10 fasteners (4)	1329-1	—

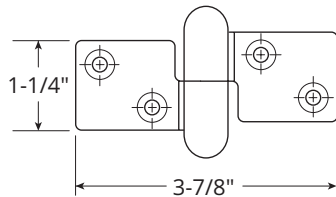

1329

Hatch Hinges

For use on flush hatch covers to prevent cover from folding all the way backward. Cover remains upright when open. Hatch hinges feature a quick-release pin with safety ring so hatch can be completely removed without unscrewing the base.

Hatch Hinge, Stainless Steel

Description	Open Size	Fastener Quantity	OEM Part #	Part #
Cast Stainless Steel	3-1/2" x 1-3/8"	#10 fasteners (4)	66027-1	66027-3

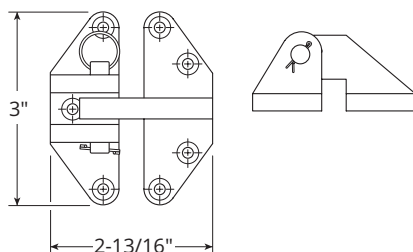

66027

Hatch & Door Hardware

Padlock Eye Clamps

For use on tackle, bait, and ice boxes that require draw-down pressure-tight seal. Also for hatch or motor box clamps. Accommodates padlocks with 1/4"-diameter or smaller shackle. Flush mount model 2012 has no exposed mounting screws. Chrome finish. Rugged, secure locking device with easy-to-use flip handle.

Description	Closed Size	Fastener Quantity	OEM Part #	Part #
Flush mount	4-1/4" x 1-1/2"	#8 fasteners (4)	2012A1	2012A3



2012A

Slam Latches

Round slam latches fits up to 7/8" door thickness. Made of UV stable and corrosion resistant materials. Include stainless steel mounting hardware.

Description	OEM Part #	Part #
Stainless Steel	66832-1	—

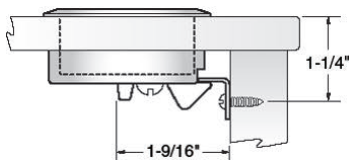

66832

Pontoon Replacement Latch

This durable lock set is a complete replacement kit for your pontoon's gate latch. Universal sizing fits square frames of 1", 1-1/8", and 1-1/4" on both left and right hinged gates. Secure closure stabilizes gate and prevents inward swinging. Includes mounting hardware for quick and easy installation.

Description	OEM Part #	Part #
Universal Replacement Gate Latch	8-1/2" x 9-1/2" x 5-1/2"	— 11404-6



11404

Swivel Hasps, Stainless Steel

For storage compartments that need to be securely locked. Ideal for lockers, cupboards, chests, and hatch doors.

Accommodates padlocks with 1/4" dia. or smaller shackle. Swivel eye turns to secure the hasp and keep the compartment shut, even without use of a padlock. Stamped stainless steel construction with chrome finish.

Description	Closed Size	Fastener Quantity	OEM Part #	Part #
Flush mount	3" x 1-1/8"	#8 fasteners (4)	66423-1	—

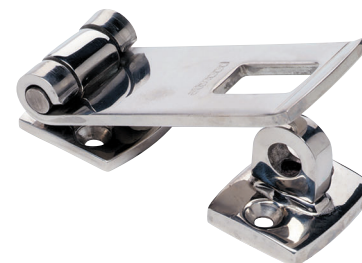
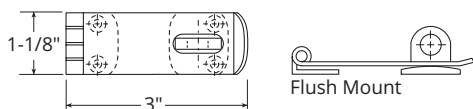

66423

Flush Hatch Pulls

The new low profile flush hatch pull is an easy access handle for installation in lids, doors, compartments, and hatches. Handle is easy to grip, even with gloved hands. Made of glass filled propylene with black textured finish.

Description	Fastener Quantity	OEM Part #	Part #
Rectangular	#6 fasteners (4)	2027-1	2027-7
Round	#6 fasteners (4)	2028-1	—

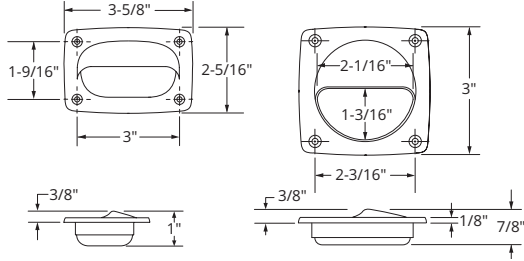

Deck Plate/Inspection Port

For inspection and general access to valves and deck vents. Easy opening, screw-out design—no tools required. High impact ABS plastic with textured surface. Durable, rugged, weather-resistant. Flange is pre-drilled with six holes.

Description	Color	Fastener Quantity	OEM Part #	Part #
4"-dia.	White	#8 fasteners (6)	12790-1	12790-3
	Black	#8 fasteners (6)	12791-1	—
6"-dia.	White	#8 fasteners (6)	12792-1	—
8"-dia.	White	#8 fasteners (6)	12794-1	—



Hatch Lift Spring, Stainless Steel

Deflecting spring holds hatch or motor box open, bends to close. Stainless steel, flush mounting.

Description	Fastener Quantity	OEM Part #	Part #
7/16"-dia. x 8-3/4"	#8 fasteners (2)	12460-1	12461-3



Handles & Hand Rails

Vinyl Grab Handles

Streamlined with a molded, hinged, built-in fastener cover system, an Attwood exclusive. A unique, grab handle that looks and works great on runabouts, fishing boats, jet boats, and RV's. Clean styling, shaped to fit your hand for a secure grip. This one-piece design eliminates the problem of loose caps which pop off over time and become lost. The covers are hinged on the base of the handle and are pushed closed after securing the mounting fasteners. Strong, polypropylene inner core with a molded vinyl cover withstands harsh marine environments. Install via thru-bolting or wood screws.

Color	Fastener Quantity	OEM Part #	Part #
White	#12 fasteners (2)	2050-1	2050-5
Gray	#12 fasteners (2)	2053-1	2053-5
Black	#12 fasteners (2)	2054-1	2054-5

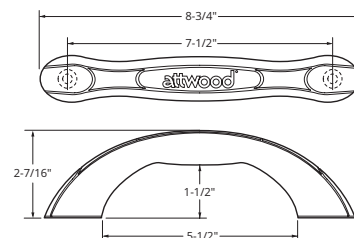
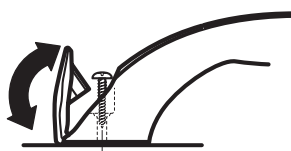

Flexible Grab Handles

Flexible grab handles for flush, flexible mounting. They can be mounted to a variety of irregular surfaces and angles on swim platforms, cockpits and companionways. Constructed from soft polypropylene webbing over a semi-rigid core. Available with or without an over-molded grip. Because of the soft, pliable webbing in these handles and the absence of any sharp edges, they are safe in areas where occupants might impact them. They meet the ABYC H-41 standard for strength: "withstand a load of 400 lbs. in any direction." All materials are non-corrosive, UV stable and mildew-resistant.

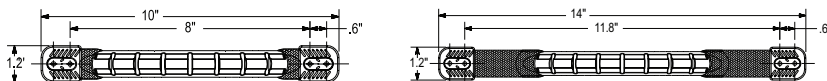

Description	Fastener Quantity	OEM Part #	Part #
Flexible grab handle w/over-molded grip	#12 fasteners (4)	2061-1	2061-5
Flexible grab handle w/over-molded grip, extended	#12 fasteners (4)	2080-1	—

Handrails, Stainless Steel

Exceed all ABYC H-41 requirements for Hand Rails. Standard and Flared configurations available.

Description	Length	OEM Part #	Part #
Flared	12"	66HRD12-1	—
Standard	9"	66HR09-1	—

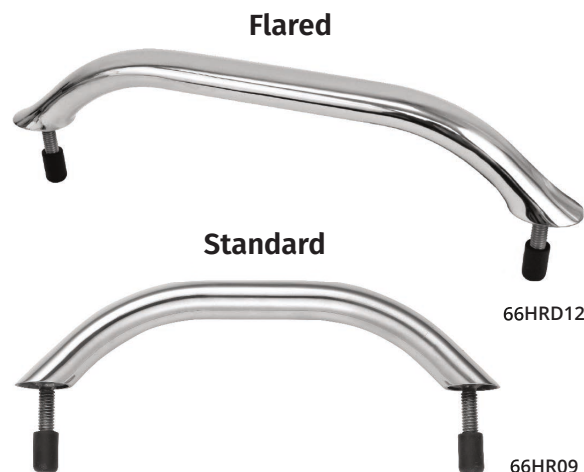

Gas Springs & Accessories

Attwood is partnered with Stabilus®, the world's leading supplier of gas springs and related products with over 100,000,000 units in the field. All Attwood springs are made with bio-degradable no hazard to water grade oil (WKG), making them the marine industry's most environmentally friendly gas springs. All springs pass ASTM B117, Attwood salt spray and a 30,000 cycle lifecycle test. Attwood springs come with support to ensure the proper spring for your specific application, including: marine, industrial, agricultural, pharmaceutical, food processing, and medical. Available in 6mm, 8mm and 10mm configurations between 10–200 lbs.

Ni-Slide Series

Attwood's widest selection of configurations and lengths. The industry's proven leader in value, quality and durability.

Stainless Steel Series

Attwood INOX Stainless Steel Series. Stainless steel shell and rod ensure corrosion-resistance and up to 30% lower cost than traditional stainless springs. All stainless steel series springs come with high-strength, corrosion-proof composite end fittings.

OEM Gas Springs

Length (inches)				Ni-Slide Series		Stainless Standard Series	
Extended	Compressed	Stroke	End Fitting Type	Available Output Force	OEM Part #	Available Output Force	OEM Part #
6 x 15 - 6MM ROD x 15MM CYLINDER							
6.50	4.90	1.60	6.3mm Dia. Blade	10-60	SL4-XX-1◇	—	—
7.50	5.25	2.25	10mm Socket	10-60	SL11-XX-1◇	10-70	ST11-XX-1◇
10.00	7.00	3.00	10mm Socket	10-60	SL10-XX-1◇	10-70	ST10-XX-1◇
12.04	8.46	3.58	10mm Socket	10-60	SL15-XX-1◇	10-70	ST15-XX-1◇
15.00	9.50	5.50	10mm Socket	10-60	SL13-XX-1◇	10-70	ST13-XX-1◇
17.20	10.20	7.00	10mm Socket	10-60	SL16-XX-1◇	—	—
20.00	12.00	8.00	10mm Socket	10-60	SL14-XX-1◇	10-70	ST14-XX-1◇
8 x 18 - 8MM ROD x 18MM CYLINDER							
7.50	5.25	2.25	10mm Socket	20-120	SL31-XX-1◇	20-120	ST31-XX-1◇
10.00	7.00	3.00	10mm Dia. Blade	20-120	SL1-XX-1◇	—	—
10.00	7.00	3.00	10mm Socket	20-120	SL30-XX-1◇	20-120	ST30-XX-1◇
10.50	7.50	3.00	10mm Socket	20-120	SL32-XX-1◇	20-120	ST32-XX-1◇
12.04	8.46	3.58	10mm Socket	20-120	SL35-XX-1◇	20-130	ST35-XX-1◇
15.00	9.50	5.50	10mm Dia. Blade	20-120	SL2-XX-1◇	—	—
15.00	9.50	5.50	10mm Socket	20-120	SL33-XX-1◇	20-150	ST33-XX-1◇
17.20	10.20	7.00	10mm Socket	20-120	SL36-XX-1◇	20-150	ST36-XX-1◇
20.00	12.00	8.00	10mm Dia. Blade	20-120	SL3-XX-1◇	—	—
20.00	12.00	8.00	10mm Socket	20-120	SL34-XX-1◇	20-150	ST34-XX-1◇
23.00	13.12	9.87	10mm Socket	30-120	SL38-XX-1◇	—	—
26.30	16.10	10.20	10mm Socket	20-120	SL37-XX-1◇	20-150	ST37-XX-1◇
10 x 22 - 10MM ROD x 22MM CYLINDER							
20.20	12.30	7.90	13mm Socket	30-240	SL20-XX-1◇	30-200	STX20-XX-1◇
20.20	12.30	7.90	10mm Socket	—	—	30-200	ST20-XX-1◇
26.30	16.10	10.20	10mm Socket	30-180	SL25-XX-1◇	—	—
26.97	15.20	11.77	10mm Socket	30-180	SL26-XX-1◇	30-200	ST26-XX-1◇
28.00	16.50	11.50	10mm Socket	30-180	SL27-XX-1◇	—	—
30.91	17.13	13.78	10mm Socket	30-180	SL28-XX-1◇	—	—
36.30	21.10	15.20	13mm Socket	30-180	SL29-XX-1◇	30-200	STX29-XX-1◇
36.30	21.10	15.20	10mm Socket	—	—	30-200	ST29-XX-1◇



Composite / Metal End Fitting (Ni-Slide)



NEW All Composite End Fitting (Stainless Steel)

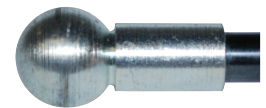

Ball Socket Stainless Steel 13mm Ball Socket



Blade End

◇ To complete the part number, replace XX with the desired available output force 10-200 (lbs.)

(Example: SL14-10-1 = 10 lbs. output force, ST26-180-1 = 180 lbs. output force)

Aftermarket Gas Springs

Popular replacement gas springs and mounting brackets for the aftermarket. Attwood has taken the guess-work out of deciding which gas springs and mounting brackets to offer your marine and RV customers. Packaged in see-through hanging packages, gas springs and mounting brackets can be plan-o-grammed together to provide an attractive one-stop display for convenient customer selection. Additional packaged gas spring sizes and output forces are available. Ask your Attwood sales rep or customer service associate for details.

Length (inches)				Standard Output Force (lbs)	Ni-Slide Series Part #	Stainless Standard Series Part #
Extended	Compressed	Stroke	End Fitting Type			
6 X 15 - 6mm Rod X 15mm Cylinder						
10	7	3	10mm Socket	40	SL10-40-5	ST10-40-5
15	9.5	5.5	10mm Socket	20	SL13-20-5	—
15	9.5	5.5	10mm Socket	60	SL13-60-5	ST13-60-5
17.2	10.2	7	10mm Socket	30	SL16-30-5	—
20	12	8	10mm Socket	20	SL14-20-5	ST14-20-5
20	12	8	10mm Socket	30	SL14-30-5	ST14-30-5
20	12	8	10mm Socket	40	SL14-40-5	ST14-40-5
20	12	8	10mm Socket	50	—	ST14-50-5
20	12	8	10mm Socket	60	SL14-60-5	ST14-60-5
8 X 18 - 8mm Rod X 18mm Cylinder						
7.5	5.25	2.25	10mm Socket	20	SL31-20-5	ST31-20-5
7.5	5.25	2.25	10mm Socket	30	SL31-30-5	ST31-30-5
7.5	5.25	2.25	10mm Socket	40	SL31-40-5	ST31-40-5
10	7	3	10mm Diameter Blade	20	SL1-20-5	—
10	7	3	10mm Diameter Blade	40	SL1-40-5	—
10	7	3	10mm Socket	20	SL30-20-5	ST30-20-5
10	7	3	10mm Socket	40	SL30-40-5	ST30-40-5
10	7	3	10mm Socket	60	SL30-60-5	ST30-60-5
10.5	7.5	3	10mm Socket	20	SL32-20-5	ST32-20-5
10.5	7.5	3	10mm Socket	30	SL32-30-5	ST32-30-5
12.04	8.46	3.58	10mm Socket	20	SL35-20-5	ST35-20-5
12.04	8.46	3.58	10mm Socket	30	SL35-30-5	ST35-30-5
12.04	8.46	3.58	10mm Socket	40	SL35-40-5	ST35-40-5
12.04	8.46	3.58	10mm Socket	50	SL35-50-5	ST35-50-5
15	9.5	5.5	10mm Diameter Blade	40	SL2-40-5	—
15	9.5	5.5	10mm Socket	20	SL33-20-5	ST33-20-5
15	9.5	5.5	10mm Socket	30	SL33-30-5	ST33-30-5
15	9.5	5.5	10mm Socket	40	SL33-40-5	ST33-40-5
15	9.5	5.5	10mm Socket	50	SL33-50-5	ST33-50-5
15	9.5	5.5	10mm Socket	60	SL33-60-5	ST33-60-5
17.2	10.2	7	10mm Socket	20	SL36-20-5	ST36-20-5
17.2	10.2	7	10mm Socket	30	SL36-30-5	ST36-30-5
17.2	10.2	7	10mm Socket	40	SL36-40-5	ST36-40-5
17.2	10.2	7	10mm Socket	50	SL36-50-5	ST36-50-5
17.2	10.2	7	10mm Socket	60	SL36-60-5	ST36-60-5
17.2	10.2	7	10mm Socket	70	SL36-70-5	ST36-70-5
17.2	10.2	7	10mm Socket	80	SL36-80-5	ST36-80-5
17.2	10.2	7	10mm Socket	90	SL36-90-5	ST36-90-5
20	12	8	10mm Diameter Blade	60	SL3-60-5	—
20	12	8	10mm Socket	20	SL34-20-5	ST34-20-5
20	12	8	10mm Socket	30	SL34-30-5	ST34-30-5
20	12	8	10mm Socket	40	SL34-40-5	ST34-40-5
20	12	8	10mm Socket	50	SL34-50-5	ST34-50-5
20	12	8	10mm Socket	60	SL34-60-5	ST34-60-5
20	12	8	10mm Socket	80	SL34-80-5	ST34-80-5
20	12	8	10mm Socket	90	SL34-90-5	ST34-90-5
20	12	8	10mm Socket	120	SL34-120-5	ST34-120-5

Threaded Studs

Used as an alternative to mounting brackets, threaded studs can be mounted directly to hatches or other mounting surfaces in applications where the mounting surface is made of metal or another material with the strength to withstand the forces of a gas spring attachment point

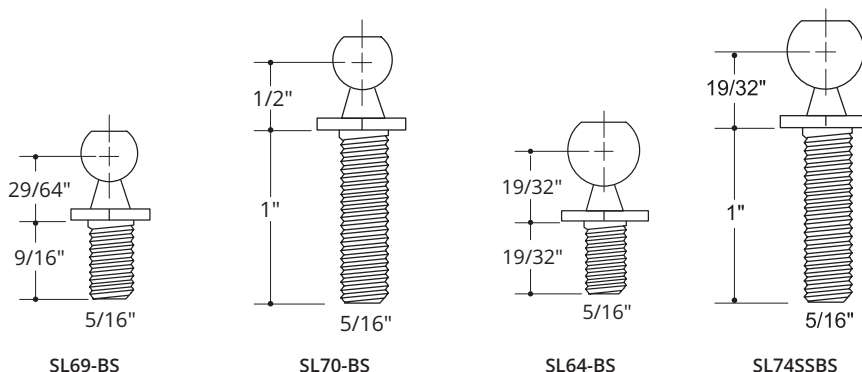

Choice of Attachment Points and Finish

Threaded studs are available with "Ball" or "Blade" gas spring attachment points, and a choice of materials, including zinc plated steel, or stainless steel.

Finish	Length	OEM Part #	Part #
With 10mm Ball End			
Zinc Plated	9/16"	SL69-BS-1	—
	1"	SL70-BS-1	—
Stainless Steel	3/4"	SL75-SSBS-1	—
	9/16"	SL69SSBS-1	—
With 13mm Ball End			
Zinc Plated	19/32"	SL64-BS-1	—
Stainless Steel	19/32"	SL64SSBS-1	—
	1"	SL74SSBS-1	—



Mounting Brackets

Mounting Brackets are used as attachment points for gas springs on hatches and other mounting surfaces where:

- Mounting surface material is not strong enough to support direct attachment of gas spring using a threaded stud
- The angle and position of the attachment point requires the need for a mounting bracket

Mounting brackets are available with Ball Pem gas spring attachment points, and a choice of materials and finishes, including zinc-plated steel (with or without black painted finish), stainless steel, or aluminum.

Aftermarket Mounting Brackets

Bracket Series No.	Style	Pem Type	Mounting Holes	Pem Direction	Finish	Part #
SL40	Flat	Ball 10mm	2	Forward	Stainless Steel	SL40SSP3-7
SL50	90°	Ball 10mm	2	Forward	Stainless Steel	SL50SSP3-7

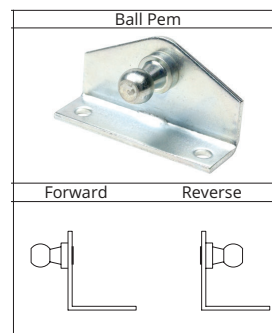

OEM Mounting Brackets

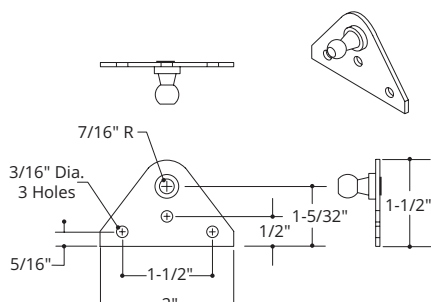

SL3H Bracket

Finish	Pem Direction	Pem Type	OEM Part #
Stainless Steel	Forward	Ball 10mm	SL3HSSP3-1

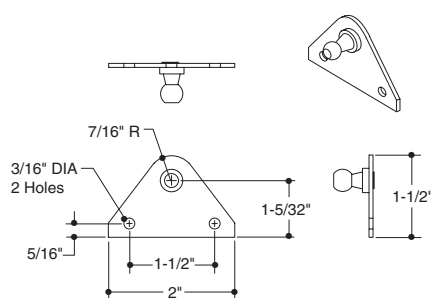

SL40 Bracket

Finish	Pem Direction	Pem Type	OEM Part #
Zinc-Plated	Forward	Ball 10mm	SL40P3-1
Black Painted	Forward	Ball 10mm	SL40BP3-1
Stainless Steel	Forward	Ball 10mm	SL40SSP3-1
Stainless Steel, Black Painted	Forward	Ball 10mm	SL40SSBP3-1

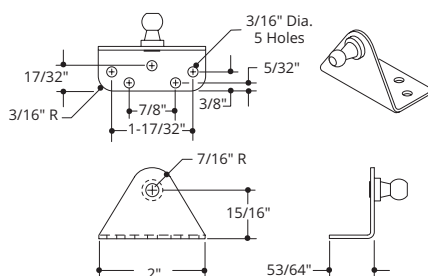

SL46 Bracket

Finish	Pem Direction	Pem Type	OEM Part #
Stainless Steel	Forward	Ball 10mm	SL46SSP3-1
	Reverse	Ball 10mm	SL46SSP3R-1

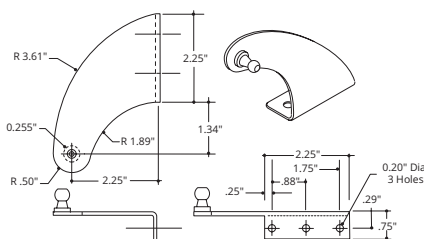

SL44 Left-Hand Crescent Bracket

Finish	Pem Direction	Pem Type	OEM Part #
Zinc-Plated	Forward	Ball 10mm	SL44P3-1
	Reverse	Ball 10mm	SL44P3R-1
Black Painted	Reverse	Ball 10mm	SL44BP3R-1
Stainless Steel	Forward	Ball 10mm	SL44SSP3-1

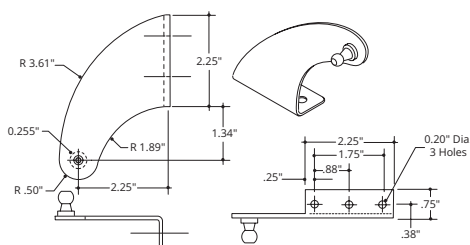

SL48 Right-Hand Crescent Bracket

Finish	Pem Direction	Pem Type	OEM Part #
Zinc-Plated	Forward	Ball 10mm	SL48P3-1
	Reverse	Ball 10mm	SL48P3R-1
Black Painted	Reverse	Ball 10mm	SL48BP3R-1
Stainless Steel	Forward	Ball 10mm	SL48SSP3-1

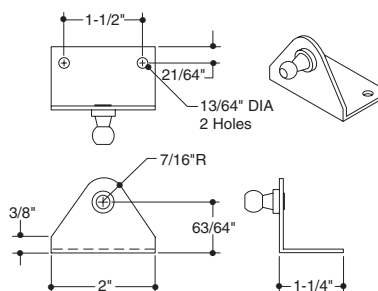

SL50 Bracket

Finish	Pem Direction	Pem Type	OEM Part #
Zinc-Plated	Forward	Ball 10mm	SL50P3-1
	Reverse	Ball 10mm	SL50P3R-1
Black Painted	Forward	Ball 10mm	SL50BP3-1
Stainless Steel	Forward	Ball 10mm	SL50SSP3-1
	Reverse	Ball 10mm	SL50SSP3R-1
Stainless Steel (3 holes)	Forward	Ball 10mm	SL50SSP3SB-1

Note: Bracket dimensions are the same with all "Pem" options. Dimensional drawings are shown with "Ball Pem" option.

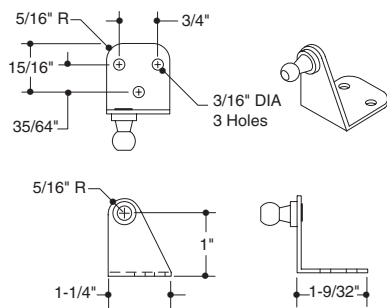

SL513H Bracket

Finish	Pem Direction	Pem Type	OEM Part #
Zinc-Plated	Reverse	Ball 10mm	SL513HP3R-1
Black Painted	Reverse	Ball 10mm	SL513HBP3R-1

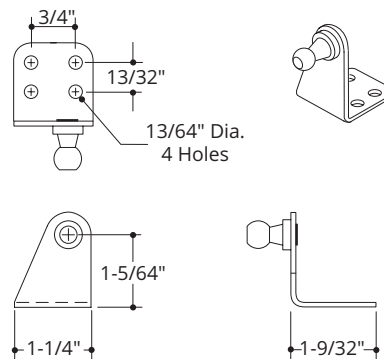

SL514H Bracket

Finish	Pem Direction	Pem Type	OEM Part #
Stainless Steel	Forward	Ball 10mm	SL514HSSP3-1

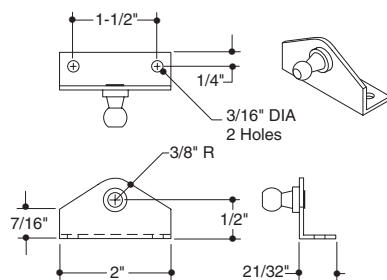

SL52 Bracket

Finish	Pem Direction	Pem Type	OEM Part #
Zinc-Plated	Forward	Ball 10mm	SL52P3-1
	Reverse	Ball 10mm	SL52P3R-1
Stainless Steel	Forward	Ball 10mm	SL52SSP3-1
	Reverse	Ball 10mm	SL52SSP3R-1

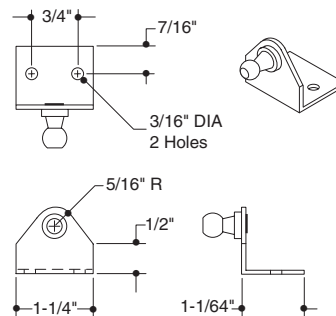

SL54 Bracket

Finish	Pem Direction	Pem Type	OEM Part #
Stainless Steel	Forward	Ball 10mm	SL54SSP3-1

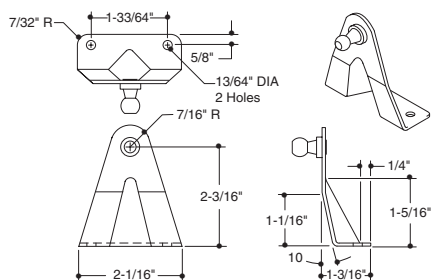

SL57 Bracket

Finish	Pem Direction	Pem Type	OEM Part #
Zinc-Plated	Forward	Ball 10mm	SL57P3-1
Stainless Steel	Reverse	Ball 10mm	SL57SSP3R-1

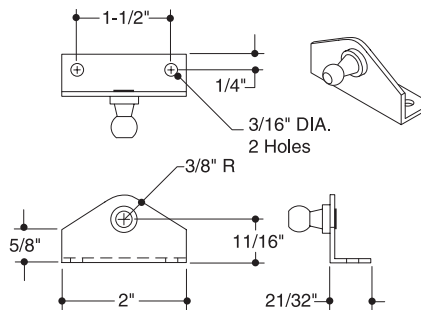

SL58 Bracket

Finish	Pem Direction	Pem Type	OEM Part #
Zinc-Plated	Forward	Ball 10mm	SL58P3-1
	Reverse	Ball 10mm	SL58P3R-1
Black Painted	Forward	Ball 10mm	SL58BP3-1
	Reverse	Ball 10mm	SL58BP3R-1
Stainless Steel	Forward	Ball 10mm	SL58SSP3-1
	Reverse	Ball 10mm	SL58SSP3R-1
Stainless Steel, Black Painted	Reverse	Ball 10mm	SL58SSBP3R-1

Note: Bracket dimensions are the same with all "Pem" options. Dimensional drawings are shown with "Ball Pem" option.

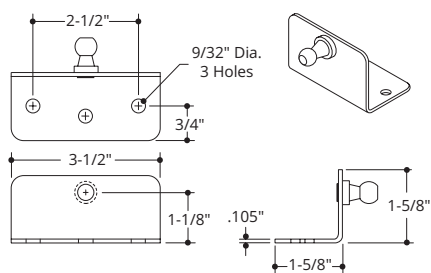

SL61 & SL63 Bracket

Finish	Pem Direction	Pem Type	OEM Part #
Stainless Steel	Forward	Ball 13mm	SL63SSBS-1
	Reverse	Ball 13mm	SL61SSBS-1

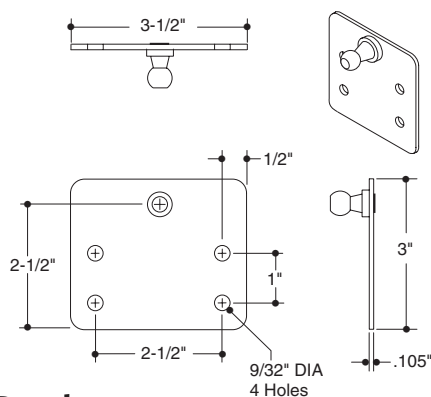

SL62 Bracket

Finish	Pem Direction	Pem Type	OEM Part #
Stainless Steel	Forward	Ball 13mm	SL62SSBS-1

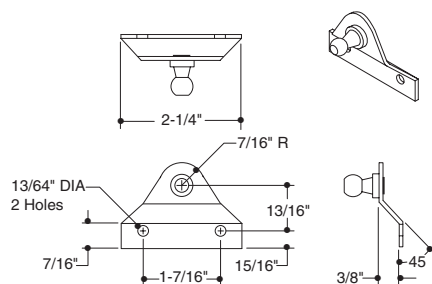

SL65 Bracket

Finish	Pem Direction	Pem Type	OEM Part #
Zinc-Plated	Forward	Ball 10mm	SL65P3-1
Black Painted	Forward	Ball 10mm	SL65BP3-1
Stainless Steel	Forward	Ball 10mm	SL65SSP3-1

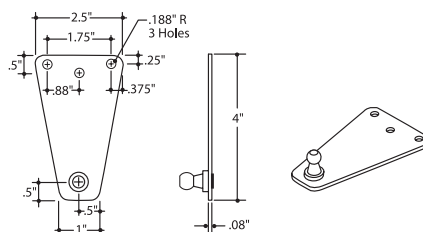

SL72 Bracket

Finish	Pem Direction	Pem Type	OEM Part #
Stainless Steel	Forward	Ball 10mm	SL72SSBS-1

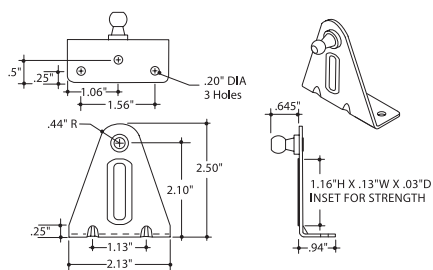

SL76 Bracket

Finish	Pem Direction	Pem Type	OEM Part #
Stainless Steel	Forward	Ball 10mm	SL76SSP3-1
	Reverse	Ball 10mm	SL76SSP3R-1

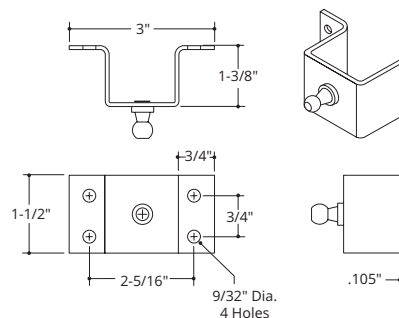

SL77 Bracket

Finish	Pem Direction	Pem Type	OEM Part #
Zinc-Plated	Forward	Ball 10mm	SL77P3-1

Note: Bracket dimensions are the same with all "Pem" options. Dimensional drawings are shown with "Ball Pem" option.

SEATING SYSTEMS & PEDESTALS



SEATING SYSTEMS & PEDESTALS

Fishing Seats



184

Attwood fishing seats are compact and provide enhanced strength and durability for long-term use.

Seating Systems



187

Find a match for every boater's style of comfort. Attwood seating and pedestal systems ensure safety, support, and comfort.

Pedestal Systems & Accessories



192

Unmatched strength, supreme stability, and ergonomic design. Attwood pedestal systems are engineered to last and exceed industry standards.



Seat Types & ABYC Requirements

Exceeds the Highest Standards

The American Boat & Yacht Council has established rigorous safety codes for seating hardware. Since seating is the critical interface between a boating passenger and a safe and comfortable boat, we exceed ABYC standards to ensure strength and safety of every product.

To make specifying simple, we've created a coding system for each seat type. Throughout this catalog, each code listed in the table shows the rating applied to individual hardware.

Seat Type: AN, Non-Operator

(Not to be used at the helm/driver position)

ABYC Requirements:

- 31.7.3 Swivel locking mechanism must sustain torque of 30 ft. lbs.
- 31.3 A seat designed for occupancy while the vessel is underway at any speed
- 31.7.1 Employ a locking mechanism for each plane or axis of movement
- 31.7.4 Seats with fore/aft adjustment must sustain static load of 300 lbs. for 3 minutes in mid position
- 31.7.5 Seats with a vertical adjustment feature shall have a positive locking mechanism
- 31.8.3 Sustain 10 impacts of 225 lbs.

Seat Type: AO, Operator

(Used at the helm/driver position)

ABYC Requirements:

- 31.7.6.1 Must have positive locking swivels which withstand 150 ft. lbs. of torque
- 31.7.6.2 All seats interchangeable with the operator's seat must meet the requirements of this section
- 31.3 A seat designed for occupancy while the vessel is underway at any speed
- 31.7.1 Employ a locking mechanism for each plane or axis of movement
- 31.7.4 Seats with fore/aft adjustment must sustain static load of 300 lbs. for 3 minutes in mid position
- 31.7.5 Seats with a vertical adjustment feature shall have a positive locking mechanism
- 31.8.3 Sustain 10 impacts of 225 lbs

Seat Type: B

(Not to be used at the helm/driver position)

ABYC Requirements:

- 31.3 A seat designed for occupancy only at boat speeds not exceeding five miles per hour
- 31.8.3 Sustain dynamic loads at 1/2 the velocity required for Type A seats

Exceptions:

- 31.2.1 ABYC H31 standards do not apply to canoes, kayaks, sailboats, inflatables, race boats, tiller steered boats and boats rated for less than 10 horsepower or manual propulsion

ABYC H31 Seat Standards

General requirements for all seat types. (AO, AN, B)

- 31.6.1 Provided with a means to prevent unintentional detachment
- 31.8.7 Withstand static load of 450 lbs.
- 31.8.13.1 Adjustable height seats must withstand vertical dynamic test

Specific ABYC requirements are based on the specific seat type.

The Factors of Seating Comfort

What makes a seat comfortable? The answer becomes complex as boating becomes more specialized and boaters more sophisticated. As your seating expert, Attwood stays ahead of design trends. In the columns below we list the universal and specialized comfort factors you should look for in any seat you choose.

Universal Factors

Contouring

- The seat's backrest follows the natural curve of the spine
- An upward curve at the back of the seat pan rotates the pelvis forward and properly positions the lumbar region
- A rounded front ("waterfall") edge reduces pressure on the thighs

Backrest Angle

- The seat relieves pressure by shifting upper body weight to the backrest, while not reducing support. This is done by angling the seat and seat mount
- Optimal seat pan-to-backrest angle is 95° -105° for passengers, 95° - 100° for drivers

Seat Height

- Pedestal height is critical for comfort and driver's vision. If too low: weight shifts onto the sitting bones. If too high: weight shifts onto back of the thighs and into the spine
- Seat height should be adjustable within a 5" range — 14-1/2" to 19-1/2" above the deck

Proper Dimensions

- Seats should fit a range of body sizes
- Attwood's seats accommodate body frames ranging from small (5th percentile female) to large (95th percentile male)

Specialized Factors

Shock Absorption

- Attwood was the first to create effective shock absorption that isolates the boater's spine from hull pounding. Attwood accomplishes this through our two revolutionary seating suspension systems. Both take a 4G hit without transferring shock to the rider by providing 3-inches of travel for a soft landing without bottoming out.

Cushioning

- On Attwood seats, the right amount of sculpted foam enhances the comfort and support already designed into the ergonomic contour
- If foam is too thick, the body "swims" without support, and movement is restricted
- If the foam is soft or thin, it "bottoms out," leading to discomfort or injury

Breathability

- Venture folding fishing seats have ventilated seat back and pan to allow pass-through of air and water for increased comfort

Accessories

- A flip-up bolster can add height and improve the field of vision for maneuvering



SAS and 4G Mesh SAS Suspensions Provide

Dynamic Comfort Underway

While underway, both SAS suspension types absorb up to 4Gs of impact from waves and hull pounding.

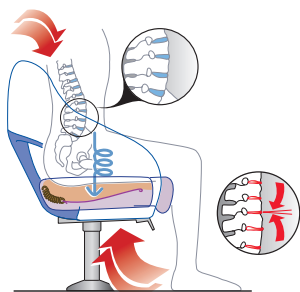

With Suspension
Impact is absorbed by the suspension — not the boater.

Without Suspension
Repeated impact can cause pain and chronic disk injury.

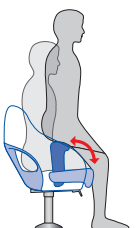

Static Comfort for Relaxing

Even while idle and sitting still, the SAS suspension adjusts to pressure and adds long term comfort.

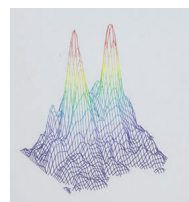
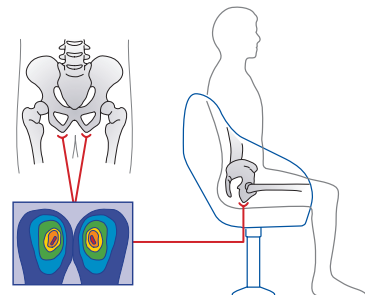

Conventional Seat
Graphs show that conventional seats allow pressure points and impaired circulation around sharp "sitting bones".

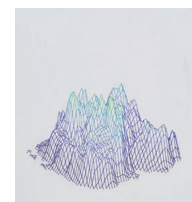

Seat with Suspension
The Attwood suspensions have stretching action to minimize pressure points.

Seating Offerings

Seat Name	Page #	OEM Part #	Part #	Material
Aergo (Kits)				
	187	98961-1	—	Plastic/Foam
		98963-1	—	Plastic/Foam
		98990-1	—	Plastic/Foam
		98991-1	—	Plastic/Foam
Avenir (Components)				
		98201-1	—	Plastic
		98202-1	—	Plastic
		98203-1	—	Plastic
		98204-1	—	Plastic
	188	7060-1	—	Plastic
		7040-1	—	Plastic
		ATT103	—	Foam
		ATT101	—	Foam
		ATT102	—	Foam
		ATT109	—	Foam
		ATT110	—	Foam
Casting Seats				
	186	—	98505WH	White Vinyl
		—	98505CA	Camo Vinyl
		—	98505GY	Gray Vinyl
Centric X (Components)				
		98900-1	—	Plastic
		98908-1	—	Plastic
	189	98910-1	—	Plastic
		ATT200-1	—	Foam
		ATT205-1	—	Foam
		ATT210-1	—	Foam
		98100-1	—	Plastic
		98120-1	—	Plastic
	190	7009-1	—	Plastic
		7006-1	—	Plastic
		98124	—	Plastic
		ATT001	—	Foam
		ATT008	—	Foam
	191	ATT009	—	Foam
		ATT016	—	Foam
		ATT002	—	Foam
		ATT007	—	Foam
Low-Back Padded Boat Seats				
	185	—	98395GY	Gray Plastic
		—	98395WH	White Plastic
		—	98395CAMO	Camo Plastic
Molded Bucket Seat				
	186	—	98390GY	Plastic
Padded Boat Seats				
	185	—	98391GNMX	Camo Plastic
		—	98391GY	Gray Plastic
Venture™ (Seat Shell Only)				
	184	97100-001-1	97100-001-2	White Plastic
		97100-005-1	97100-005-2	Gray Plastic
		97100-006-1	97100-006-2	Olive Plastic

Find a Match for Every Boater's Style Of Comfort

Attwood offers the right seating style for every type of recreational boating, and every type of customer.

Folding Seats

For all fishing boats and pontoon boats



Venture™

- The best ergonomic contouring for cool comfort, with or without upholstery
- Patented no-pinch folding hinge



Low Back Fold Down Fishing Seats

- High impact plastic frame and aluminum hinges
- UV resistant
- Easy to clean vinyl



Padded Flip Boat Seats

- Thick and comfortable padding
- Compact and lightweight

Bucket Seating

For cruisers, runabouts, deck boats, and pontoon boats



Molded Bucket Seat

- Made from high-impact plastic
- Comfortable, ergonomic design

Casting Seat

For all fishing boats and pontoon boats



- Offers support and comfort for long-term use
- Made with marine-grade vinyl
- Works with any casting seat application

Fishing Seats

Venture™ Folding Fishing Seat

The Venture folding fishing seat is designed to satisfy the widest possible range of boaters and boat builders. Mounts in any location on bass boats, aluminum fishing boats, fish'n ski, pontoon and deck boats. Its advanced styling distinguishes it from all other seats on the market.

Ventilated

Seat back and pan are ventilated to allow pass-through of air and water for increased comfort.

Portability

Venture quickly folds away to allow more room for activity and fishing excitement. Then it can be easily removed and transported using the built-in carry handle.



97100-005

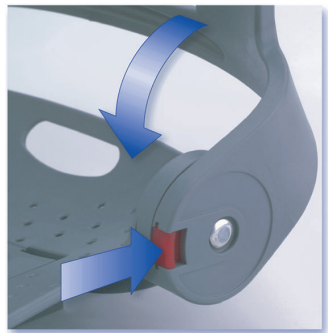

Simple, Pinch-Proof Hinge and Lock Push-button release automatically locks the seat back in upright sitting position or the folded position for transport.

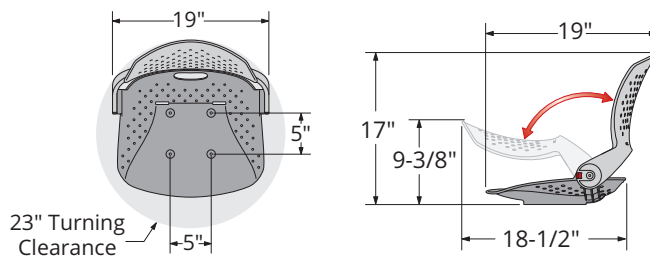

Seat Shell Only

Color	ABYC Code	OEM Part #	Part #
White	B	97100-001-1	97100-001-2
Medium Gray	B	97100-005-1	97100-005-2
Olive	B	97100-006-1	97100-006-2

B (Not to be used at the helm/driver position)

See page 180 for ABYC Requirements



98395WH

Low-Back Padded Boat Seat

This seat features a high impact plastic frame and aluminum hinges. It is UV and mildew resistant with easy to clean vinyl and a standard seat hole mounting pattern. 7"W x 16"D x 16"H.

Color	ABYC Code	OEM Part #	Part #
Gray	B	—	98395GY
White	B	—	98395WH
Camo	B	—	98395CAMO

B (Not to be used at the helm/driver position)

See page 180 for ABYC Requirements



98391GV

98391GNMX

Padded Boat Seat

This padded boat seat is a comfortable and convenient addition to your boat's seating. It features thick padding, making your activities comfortable for long periods of time. It's compact and lightweight design makes it easy to transport. 20"W x 17"D x 12"H.

Color	ABYC Code	OEM Part #	Part #
Camo	B	—	98391GNMX
Gray	B	—	98391GY

B (Not to be used at the helm/driver position)

See page 180 for ABYC Requirements





98390GY



98505WH



98505GY



98505CA

Molded Bucket Seat

This one piece molded plastic boat seat is made from high-impact plastic. Seat includes mounting screws. 18"W x 21"D x 16"H.

Color	ABYC Code	OEM Part #	Part #
Gray	B	—	98390GY

Casting Seats

This casting seat is constructed with quality materials and workmanship. Made with marine-grade vinyl, it offers long-term support and comfort. A universal casting seat, it works with any casting seat application. Available in white, gray or camo. 15"W x 11"D x 6"H.

Color	ABYC Code	OEM Part #	Part #
White	B	—	98505WH
Camo	B	—	98505CA
Gray	B	—	98505GY

B (Not to be used at the helm/driver position)

See page 180 for ABYC Requirements



Seating Systems

Aergo Seat Systems

These Aergo Kits contain all the molded foam and plastic in one! Our 4G Mesh SAS Shock Absorbing System and molded-in armrests give extra functional elements to the design and ergonomic comfort of this seat. These kits contain the molded core, pan, and bolster plastic and foam pieces. You can choose either the standard kit, which contains standard bolster foam, or the large bolster kit which has larger bolster foam for added comfort during elevated seating.

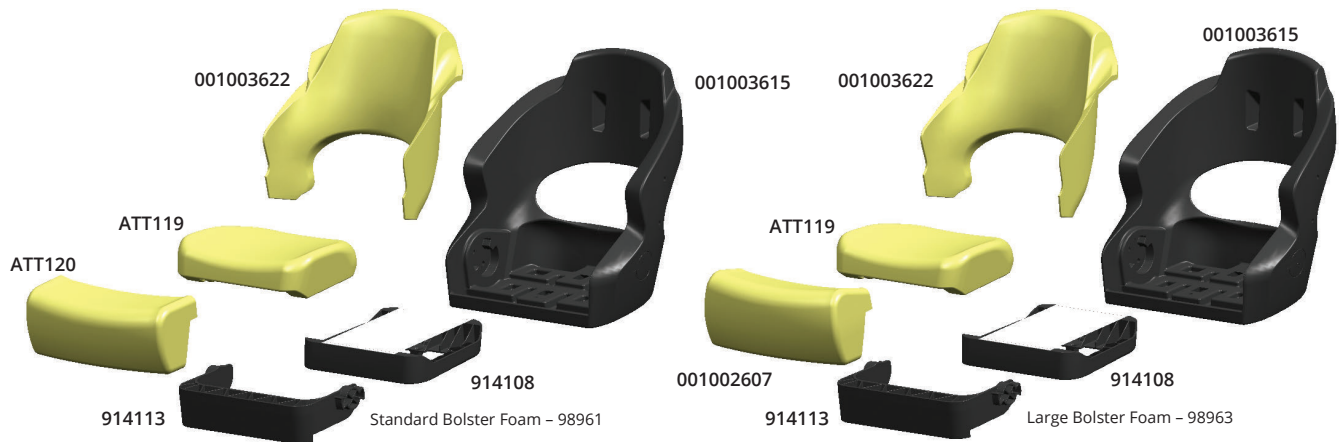

Aergo 240 Kits

Description	ABYC Code	OEM Part #	Part #
Aergo 240 Kit with standard bolster	AO, AN	98961-1	—
Aergo 240 Kit with large bolster	AO, AN	98963-1	—



Aergo 220 Kits

Description	ABYC Code	OEM Part #	Part #
Aergo 220 Kit with standard bolster	AO, AN	98990-1	—
Aergo 220 Kit with large bolster	AO, AN	98991-1	—

AN: Non-Operator (Not to be used at the helm/driver position)
AO: Operator (Used at the helm/driver position)

See page 180 for ABYC Requirements

Avenir™ Sport & Avenir™ Seat Systems

Avenir molded seating components have just four interlocking parts. This easy-to-install design, along with the universal hole pattern, reduces your upholstery and installation costs. Avenir uses marine-grade materials, a thermoplastic shell, and a stainless steel suspension grid with corrosion proof springs. These components utilize a shell and backrest upholstery onsert which speeds up the upholstery of the seat and provide an easy means of adding stylish accent piece with deep-tuck seam. Onsert posts snap securely into the seat shell using foolproof clips for a quick and easy assembly.



Avenir Complete Kits

Description	Includes	ABYC Code	OEM Part #	Part #
Avenir Sport Kits				
Standard	ATT101, ATT102, ATT110, 7034, 7043, 7044	AO, AN	98201-1	—
Lumbar	7033, ATT101, ATT102, ATT110, 7034, 7043, 7044	AO, AN	98202-1	—
Headrest	7032, ATT101, ATT102, ATT109, 7034, 7043, 7044	AO, AN	98203-1	—
Avenir Midback Kit				
Avenir Midback Kit	7040-1, 7023, 7041, 7043, 7044, 7060-1, ATT101, ATT102, ATT103	AO, AN	98204-1	—



Avenir Upholstery Trim Rings

Avenir Upholstery Trim Rings provide a finished cap to cover seam where mesh and vinyl meet in ventilation holes at back of seat.

Description	ABYC Code	OEM Part #	Part #
Avenir Midback Trim Rings			
Left Side Trim Ring, White Plastic	AO, AN	7060-1	—
Right Side Trim Ring, White Plastic	AO, AN	7040-1	—



Avenir Molded Foam Packs

Molded foam packs are contoured specifically to enhance an ergonomic design for maximum comfort and style. Eliminates labor-intensive and costly cut foam and provides a consistent shape that improves the quality of the upholstered seat.

Description	For Use with Component	ABYC Code	OEM Part #	Part #
Avenir Midback Foam Packs				
Avenir Midback Backrest Foam	—	AO, AN	ATT103	—
Seat Pan Foam Packs				
SAS Seat Pan	—	AO, AN	ATT101	—
Bolster Foam Packs				
Flip-up Bolster	—	AO, AN	ATT102	—
Avenir Sport Foam Packs				
Avenir Sport Backrest with Headrest	—	AO, AN	ATT109	—
Avenir Sport Backrest with Lumbar Option	—	AO, AN	ATT110	—

For questions regarding Attwood's most up-to-date seating selections, or for assistance with your seating application, contact your Sales Representative or Attwood Customer Service

AN: Non-Operator (Not to be used at the helm/driver position)

AO: Operator (Used at the helm/driver position)

See page 180 for ABYC Requirements

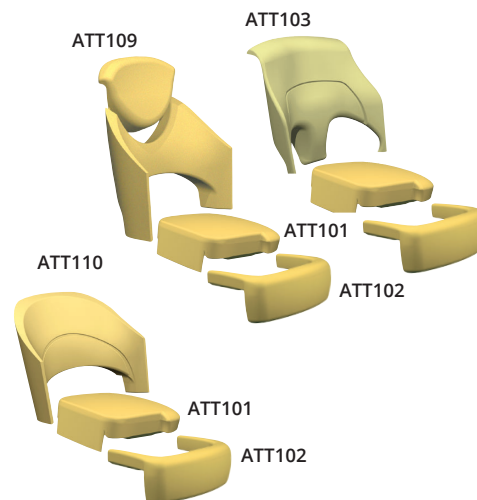

Centric X Seat Systems

These sleek, functional, and ergonomically designed seats provide the new look you've been looking for in folding fishing or helm seats! Just choose the base plastic kit that suits your functional needs. Then choose a stylish foam kit and complete your look.



Centric X Seat Shell Kits

Centric X seat shell kits contain all plastic components to assemble. Base pieces include corrosion-resistant T-nuts for pedestal attachment. Kits include assembly hardware.

Description	For Use with Foam Pack	ABYC Code	OEM Part #	Part #
Non-SAS, Gray	ATT200-1, ATT205-1, or ATT210-1	AO, AN	98900-1	—
Non-SAS, Dark Gray	ATT200-1, ATT205-1, or ATT210-1	AO, AN	98908-1	—
Non-SAS, Duck	ATT200-1, ATT205-1, or ATT210-1	AO, AN	98910-1	—

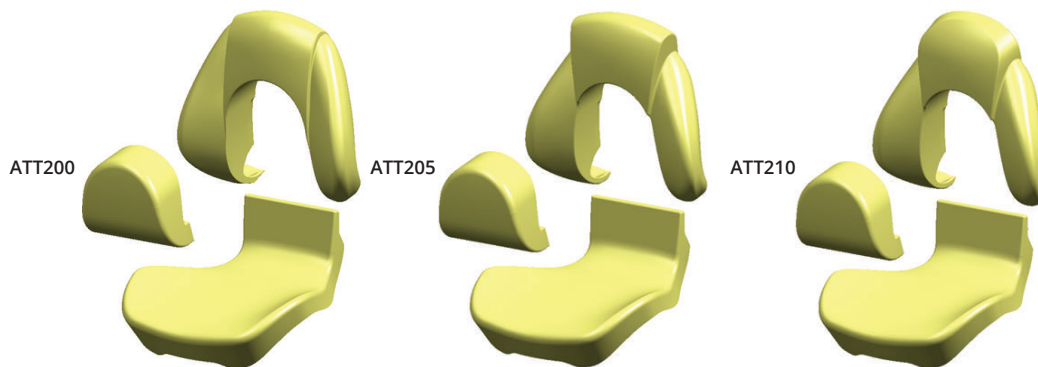

Centric X Molded Foam Packs

Centric X molded foam kits come in a variety of shapes to fit your individual styling needs.

Description	ABYC Code	OEM Part #	Part #
Non-SAS Standard Foam Pack	AO, AN	ATT200-1	—
Non-SAS Flared Headrest Foam Pack	AO, AN	ATT205-1	—
Non-SAS Rounded Headrest Foam Pack	AO, AN	ATT210-1	—

For questions regarding Attwood's most up-to-date seating selections, or for assistance with your seating application, contact your Sales Representative or Attwood Customer Service

AN: Non-Operator (Not to be used at the helm/driver position)

AO: Operator (Used at the helm/driver position)

See page 180 for ABYC Requirements

Centric Seat Systems

With all of its features, Centric is surprisingly easy to upholster using our molded foam packs. Centric seat components consist of blow-molded fishing or helm seat cores, injection molded upholstery inserts for the backrest and seat back hinge cover, and molded foam packs.

Centric Seat Core Kits

Centric seat core kits include the seat pan with a choice of Mid-Back and High-Back backrest styles. Each seat includes a separate seatback insert to cover and protect the hinge. Insert can be applied and then upholstered over with the rest of the seatback or upholstered separate of the seatback as a means of providing an accent piece. Seat cores include corrosion-resistant T-nuts for attachment to seat pedestals.

Centric Upholstery Inserts

The Upholstery Inserts speed up the upholstery of the backrest and provide an easy means of adding a stylish accent piece with deep-tuck seam. Insert posts snap securely into seat core using foolproof clips for quick, easy assembly.



Description	For Use with Foam Packs	ABYC Code	OEM Part #	Part #
Seat Cores and Inserts				
Mid-Back Core, Black	ATT001, ATT002, ATT007	AO, AN	98100-1	—
High-Back Core, Black	ATT007, ATT008	AO, AN	98120-1	—
Mid-Back Onsert	ATT009	AO, AN	7009-1	—
High-Back Onsert	ATT008	AO, AN	7006-1	—
Mid-Back II Onsert	ATT016	AO, AN	98124	—

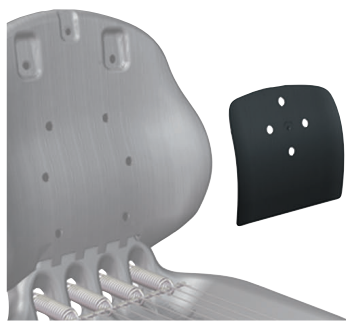

7009



7006



98124

AN: Non-Operator (Not to be used at the helm/driver position)

AO: Operator (Used at the helm/driver position)

See page 180 for ABYC Requirements

Centric Molded Foam Packs

Molded foam packs are contoured to enhance the ergonomic shape of Centric's seat core for maximum comfort and style. Eliminates labor-intensive and costly cut foam and provides a consistent shape that improves the quality of the upholstered seat. Centric foam packs are offered with a choice of integrated "hook and loop" or "onsert" upholstery methods.

Hook and Loop - Joins upholstery seam-to-foam to form a moderate tuck.

Onserts - provide a deep tucked seam depth by using a separate upholstered panel.



ATT001



ATT008



ATT009

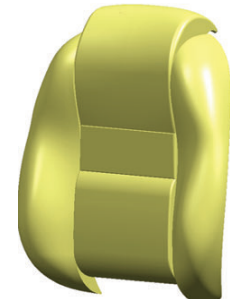

ATT016

Description	For Use with Component(s)	ABYC Code	OEM Part #	Part #
Backrest Foam Packs				
Mid-Back, Hook & Loop	98100	AO, AN	ATT001	—
High-Back, w/Onsert	98120, 7006	AO, AN	ATT008	—
Mid-Back, w/Onsert	98100, 7009	AO, AN	ATT009	—
Mid-Back II Foam Pack	98121, 98124	AO, AN	ATT016	—
Seat Pan Foam Packs				
Sport Weight Hook & Loop	98100, 98200, 98120, 98121	AO, AN	ATT002	—
Luxury Weight Hook & Loop	98100, 98200, 98120, 98121	AO, AN	ATT007	—

For questions regarding Attwood's most up-to-date seating selections, or for assistance with your seating application, contact your Sales Representative or Attwood Customer Service.

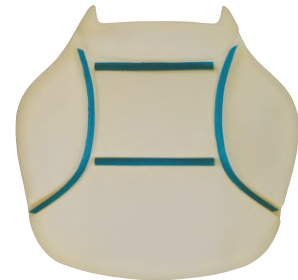

ATT002

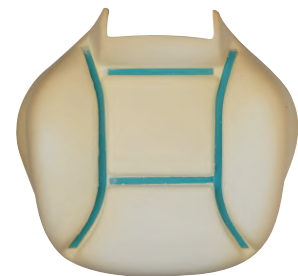

ATT007

AN: Non-Operator (Not to be used at the helm/driver position)

AO: Operator (Used at the helm/driver position)

See page 180 for ABYC Requirements

Pedestal Systems & Accessories

278 Series Pedestal System Strong. Stable. Smooth.

Unmatched Strength.

- Heavy-duty casting easily supports popular oversized helm seats.

Supreme Stability.

- A rigid mount and wider seat interface create ultimate pedestal robustness.

Extra Smooth.

- Improved slider motion facilitates easy fore and aft movement. Dampening gas spring on the 278 Air System absorbs impact.



278 Pro System
Fixed Height Pedestal

278 Air System
Adjustable Height Pedestal

Dimensions of 278 Pro & 278 Air Systems
NOTE: 278 Pro & 278 Air System components are not compatible with other seating systems.

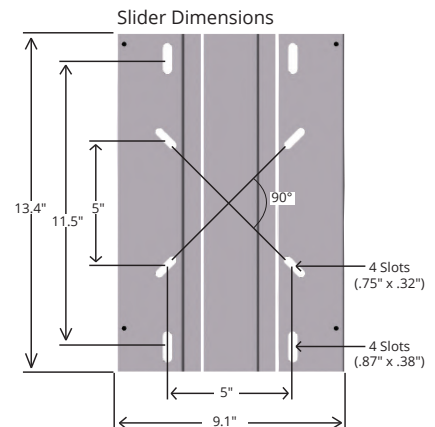
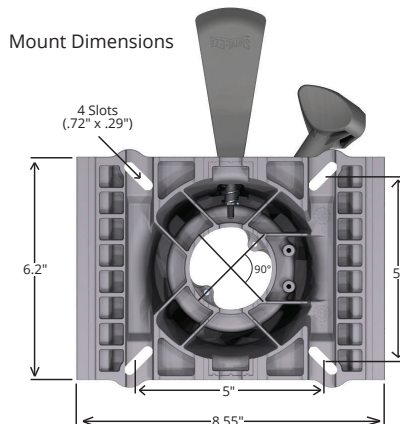
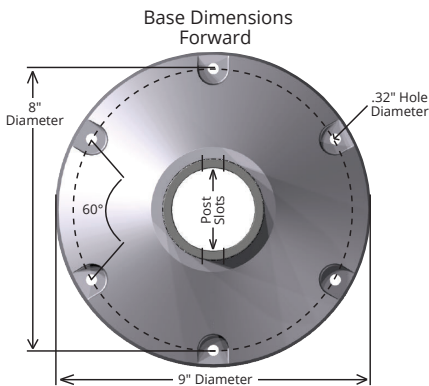
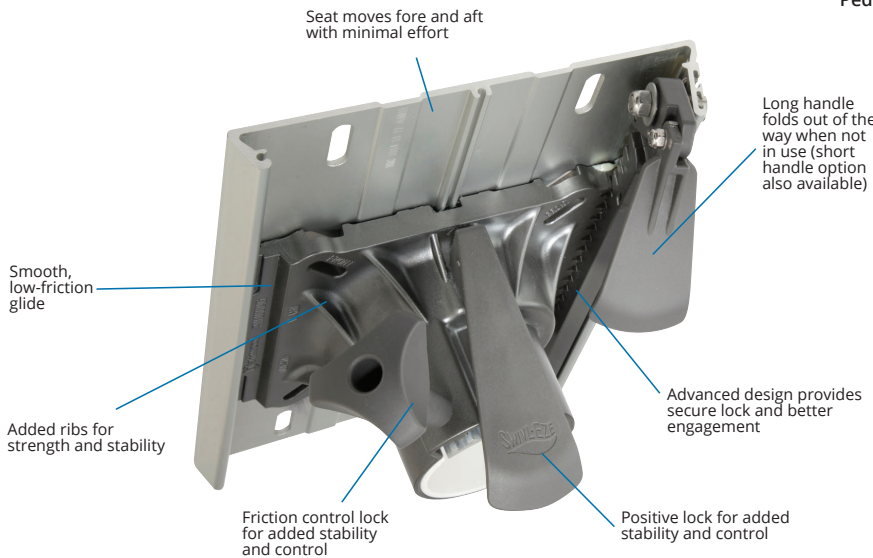
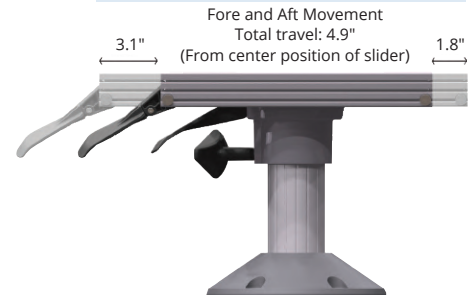

278 Air System (Adjustable Height Pedestal)

Description	ABYC Code	Base Height	Slider Handle	Base Finish	OEM Part #
Bases (For total system height, add 1" to the base height)					
278 Air Pedestal Base, 2.75" Below Deck	AO	9-12"	—	Gray	278AOP0912-BD-1
278 Air Pedestal Base	AO	12-15"	—	Gray	278AOP1215-1
278 Air Pedestal Base	AO	15-19"	—	Gray	278AOP1519-1
278 Air Pedestal Base	AO	19-23"	—	Gray	278AOP1923-1
Seat Mounts					
278 Pro Mount, 3 degree	AO	—	—	—	278AO3AM-1
278 Pro Mount, 0 degree	AO	—	—	—	278AOZAM-1
278 Mounts with Slider					
278 AirGlide Slider, 0 degree	AO	—	Short	—	278AOZAGS-1
278 AirGlide Slider, 0 degree	AO	—	Long	—	278AOZAGL-1
278 AirGlide Slider, 3 degree	AO	—	Short	—	278AO3AGS-1
278 AirGlide Slider, 3 degree	AO	—	Long	—	278AO3AGL-1

278 Pro System (Fixed Height Pedestal)

Description	ABYC Code	Base Height	Slider Handle	Base Finish	OEM Part #
Bases					
278 Pro Pedestal Base, Low Profile	AO	5"	—	Bright	—
278 Pro Pedestal Base	AO	6"	—	Gray	278AOGY060-1
278 Pro Pedestal Base	AO	7"	—	Gray	278AOGY070-1
278 Pro Pedestal Base	AO	8"	—	Gray	278AOGY080-1
278 Pro Pedestal Base	AO	9"	—	Gray	278AOGY090-1
278 Pro Pedestal Base	AO	10"	—	Gray	278AOGY100-1
278 Pro Pedestal Base	AO	11"	—	Gray	278AOGY110-1
278 Pro Pedestal Base	AO	12"	—	Gray	278AOGY120-1
278 Pro Pedestal Base	AO	13"	—	Gray	278AOGY130-1
Seat Mounts					
278 Pro Mount, 3 degree	AN	—	—	—	278ANZPM-1
278 Pro Mount, 0 degree	AO	—	—	—	278AOZPM-1
278 Pro Mount, 3 degree	AO	—	—	—	278AO3PM-1
Seat Mounts with Slider					
278 ProGlide Slider, 3 degree	AO	—	Long	—	278AO3PGL-1
278 ProGlide Slider, 0 degree	AO	—	Long	—	278AOZPGL-1



278 Air Pedestal Base, Below Deck

278 Air Pedestal Base



278 Air Mount



278 AirGlide Slider, Short Handle



278 AirGlide Slider, Long Handle



278 Pro Pedestal Base, Low Profile



278 Pro Pedestal Base



278 Pro Mount, AN



278 Pro Mount, AO



278 ProGlide Slider, Long Handle

AN: Non-Operator (Not to be used at the helm/driver position)

AO: Operator (Used at the helm/driver position)

See page 180 for ABYC Requirements

238 Series 2-3/8"

Strength, style and corrosion-resistance

- Pedestal tubes are hard-anodized aluminum
- All springs are stainless steel
- Bases are bead-blasted (to close aluminum porosity) and clear coated

Smooth movement without wobble

- Slider has gear-tooth lock mechanism; locks solidly, disengages easily
- Slider rides smoothly on acetal linear bearings

Clean style, ergonomic design

- Styling is clean and uncomplicated
- Handles are ergonomically designed to be easy on the hands and easy to reach

Not recommended to interchange with other manufacturers' products



238162



238512



238312

Reinforced polymer handle is thicker for strength and more comfortable grip.

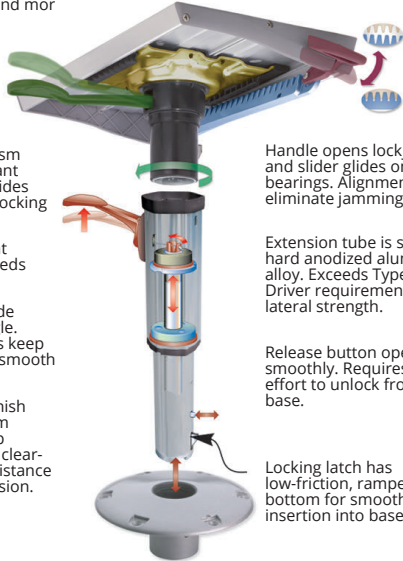

Seat mount mechanism is redesigned. Constant pressure spring provides continuous forward locking pressure.

Cable-actuated height mechanism never needs adjustment.

Linear grooves provide support, reduce wiggle. Acetal linear bearings keep the whole operation smooth and wobble free.

Bead-blasted base finish pounds the aluminum surface and closes up porosity. Proprietary clear-coating improves resistance to scuffing and corrosion.

Handle opens lockjaw gears... and slider glides on acetal linear bearings. Alignment tracks eliminate jamming and wobbling.

Extension tube is super-hard anodized aluminum alloy. Exceeds Type A Driver requirements for lateral strength.

Release button operates smoothly. Requires less effort to unlock from base.

Locking latch has low-friction, ramped bottom for smooth insertion into base.

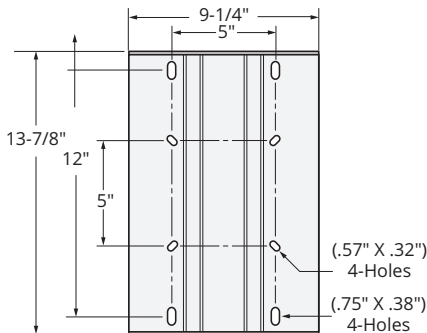

238 Pedestal Kits

Attwood's 2-3/8" pedestal kit is strong, durable, and corrosion resistant. The kit includes a 360 degree swivel seat mount, removable extension post, and 9" base. Available in satin aluminum or Realtree MAX-4 Camouflage.

Description	ABYC Code	Req. Dia. Mounting Hole	OEM Part #	Part #
Base Plate: 9", Seat Mount 5" X 5" on Center				
Pedestal Kit with 9" Satin Post	AO	3"	—	23809-7
Pedestal Kit with 11" Satin Post	AO	3"	—	23811-7
Pedestal Kit with 13" Satin Post	AO	3"	—	23813-7
Pedestal Kit with 15" Satin Post	AO	3"	—	23815-7



238 Series Seat Mounts

Description	ABYC Code	OEM Part #	Part #
Seat Mounts without Slider			
Stainless Steel, 3° Tilt, Left Handle	AO	238141-1	—
Stainless Steel, 3° Tilt, Right Handle	AO	238142-1	238142-7
Plated Steel, 0° Tilt, Left Handle	AO	238150-1	—
Plated Steel, 3° Tilt, Left Handle	AO	238151-1	—
Plated Steel, 3° Tilt, Right Handle	AO	238152-1	238152-7
Plated Steel, 3° Tilt, Forward Handle	AO	238153-1	238153-7
Seat Mounts with Aluminum Slider			
Plated Steel, 3° Tilt, Right Handle	AO	238162-1	238162-4
Plated Steel, 0° Tilt, Right Handle	AO	238164-1	—



Slider Movement Range

AO: Operator (Used at the helm/driver position)

See page 180 for ABYC Requirements

238 Series Pedestals & Extension Posts

Description	ABYC Code	OEM Part #	Part #
Fixed Height Bell Pedestals*			
8" Height	AO	238908-1	—
11" Height	AO	238911-1	—
12" Height	AO	238912-1	—
13" Height	AO	238913-1	—
15" Height	AO	238915-1	—
Fixed Height Extension Posts*			
8" Height	AO	238608-1	—
9" Height	AO	238609-1	—
10" Height	AO	238610-1	238610-3
11" Height	AO	238611-1	—
12" Height	AO	238612-1	238612-3
13" Height	AO	238613-1	238613-3
14" Height	AO	238614-1	—
15" Height	AO	238615-1	238615-3
17" Height	AO	238617-1	—
25" Height	AO	238625-1	—
30" Height	B	238630-1	—
	B	238630L1	—
Pro-Pole Extension Posts - Type B*			
27" Height	B	238027-1	238027-3
Adjustable Height Power Pedestals*			
13" to 16-1/2" Height	AO	238512-1	238512-4
19-1/2" to 23" Height	AO	238522-1	238522-4

* Height measured from deck to top of seat mount



238908



238617



238512



238609

238 Series Socket Bases

Bases are interchangeable between LakeSport 238 Series and 238 Series.

Description	ABYC Code	Req. Dia. Mounting Hole	OEM Part #	Part #
Aluminum 9" Round, Clear Coat Finish	AO	3"	238312-1	238312-2
Aluminum 9" D-Shaped, Clear Coat Finish	AO	3"	238322-1	—
Stainless Steel, 7" x 7", Square, Centered Hole	AO	3"	238333-1	—
Aluminum 9" Cut Both Sides, Clear Coat Finish	AO	3"	238352-1	—
238 Series Socket Base Splash Guard				
Socket Splash Guard, Plastic	AO	—	238300-1	—

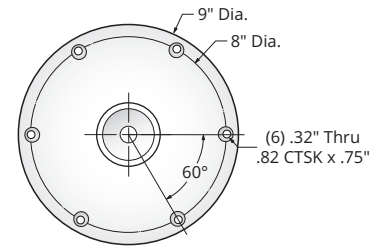

238312



238352

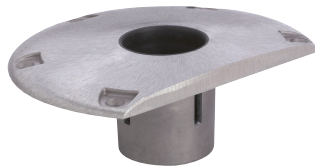

238333



238322



238300

AO: Operator (Used at the helm/driver position)

B (Not to be used at the helm/driver position)

See page 180 for ABYC Requirements

LakeSport 238 Series

The Difference

- These sturdy 2-3/8" diameter pedestal systems have all the strength and durability you need for years of family fishing enjoyment.
- Hard anodized aluminum pedestal tubes
- Bead blasted finish pounds the aluminum surface and closes up porosity
- All LakeSport 238 Series hardware is engineered to exceed ABYC standards

Type A/Operator Models lead the industry with these features:

- Ergonomic positive-locking handle with stainless steel components



818440

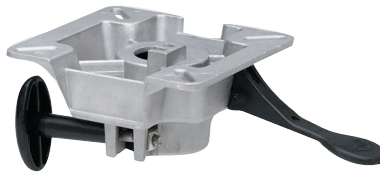

818441



828461

LakeSport 2-3/8" Seat Mounts

Description	ABYC Code	OEM Part #	Part #
Seat Mounts Without Slider Installed Height: 5/8"			
Aluminum, w/ Friction Control, 3° Tilt	AN	818440	—
Aluminum, w/ Friction Control, 3° Tilt	AO	818441	818441-3
Seat Mounts with Aluminum Slider Installed Height: 1"			
Aluminum, w/ Friction Control, 3° Tilt	AO	828461	—

LakeSport 2-3/8" Extension Posts

For LakeSport seat mounts only

Description	ABYC Code	OEM Part #	Part #
Fixed Height Extension Posts*			
10" Height, Anodized Finish	AN	238610L1	—
11" Height, Anodized Finish	AN	238611L1	—
13" Height, Anodized Finish	AN	238613L1	—

* Height measured from deck to top of seat mount



238610L1

AN: Non-Operator (Not to be used at the helm/driver position)

AO: Operator (Used at the helm/driver position)

See page 180 for ABYC Requirements

LakeSport 2-3/8" Seat Pedestals

Description	ABYC Code	OEM Part #	Part #
Hydraulic Power Pedestals with Seat Mount*			
12" - 15" Adjustable Height, Anodized Finish	AO	238813LSM1	—
25" - 32" Adjustable Height, Anodized Finish	B	238833LSM1	—
Fixed Height Bell Pedestals*			
11" Height	AO	238911L1	—
13" Height	AO	238913L1	—
Fixed Height Bell Pedestals with Seat Mount*			
9" Height	AN	238909LSM1	—
13" Height	AN	238913LSM1	—
16" Height	AN	238916LSM1	—
Adjustable Height Bell Pedestals with Seat Mount, Manual*			
14"-20" Adjustable Height, Anodized	AN	—	2385400
12-1/2"-15-1/2" Adj. Height, J-Slot, Anodized	AO	—	2385405

* Height measured from deck to top of seat mount



LakeSport 2-3/8" Socket Bases

Bases are interchangeable between LakeSport 238 Series and 238 Series.

Description	ABYC Code	Req. Dia. Mounting Hole	OEM Part #	Part #
Aluminum 9" Round, Clear Coat Finish	AO	3"	238312-1	238312-2
Aluminum 9" D-Shaped, Clear Coat Finish	AO	3"	238322-1	—
Stainless Steel, 7" x 7", Square, Centered Hole	AO	3"	238333-1	—
Aluminum 9" Cut Both Sides, Clear Coat Finish	AO	3"	238352-1	—
238 Series Socket Base Splash Guard				
Socket Splash Guard, Plastic	AO	—	238300-1	—

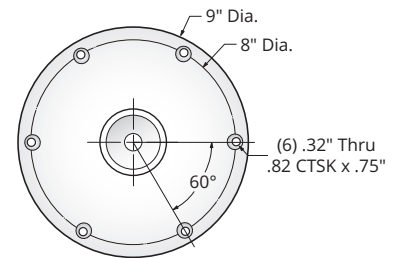

AN: Non-Operator (Not to be used at the helm/driver position)

AO: Operator (Used at the helm/driver position)

B (Not to be used at the helm/driver position)

See page 180 for ABYC Requirements

Wedge 2" & 2-3/8"

Wedge shaped components slide in for a snug, stable fit

- Type B mounts are not designed to "lock" into post
- Engineered to prevent unintentional detachment

Posts

- Heavy-duty bushing with peripheral bearing system and exclusive "crush ribs" are individually sized for exact fit
- Pedestals come in a few lengths, including patented "J-Slot" adjustable height
- Locking tab positively locks post to base
- Wedge™ bushing locks in with a tight, solid fit
- 2-Point stainless steel riveting strengthens the bushing

Bases

- Strong base design has reinforcing ribs and improved profile to withstand the toughest conditions
- Bead blasting closes aluminum porosity. Brushing process provides long-lasting high-sheen finish

Not recommended to interchange with other manufacturers' products

Wedge 2" Seat Mounts

Description	ABYC Code	Installed Height	OEM Part #	Part #
Cast Aluminum, Black E-Coat Steel, 3° Tilt	B	3"	—	SP-18914



SP-18914

Wedge 2" Extension Posts

Description	ABYC Code	OEM Part #	Part #
2" Fixed Height Posts			
11" Satin Anodized	B	—	SP-28911
13" Satin Anodized	B	—	SP-28913

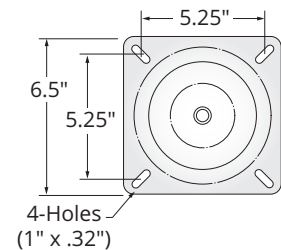

Wedge 2-3/8" Extension Posts

Description	ABYC Code	OEM Part #	Part #
2-3/8" Adjustable Height Posts - Power Pedestals (w/ Integral Seat Mount)			
14" - 20" Satin Anodized	B	—	SP-37904
24" to 30" Satin Anodized	B	—	SP-37914



SP-28911

SP-37904

Wedge 2" Base Plates

Description	ABYC Code	Req. Dia. Mounting Hole	Depth Below Deck	OEM Part #	Part #
9" Round, Brushed Aluminum	AO	3.25"	2"	—	SP-68914

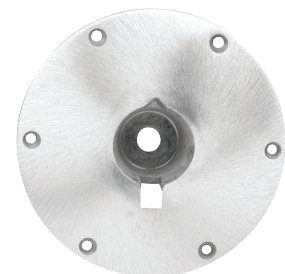

SP-68914

AO: Operator (Used at the helm/driver position)

B (Not to be used at the helm/driver position)

See page 180 for ABYC Requirements

Lock'N-Pin 3/4" Pin



#1 supplier of 3/4" pin seating hardware. Here's why:

- The 3/4" system gives you outstanding economical performance
- The design is proven by decades of experience
- Posts are available as fixed, manually adjustable or power adjustable
- Seat mounts, posts and bases are available in steel, aluminum or stainless steel

The Difference

- The patented Lock'N-Pin system leads the industry in safety
- Lock'N-Pin prevents unintentional detachment for seat mounts, posts and bases
- Lock'N-Pin products exceed ABYC Standard H31.6.1

Not recommended to interchange with other manufacturers' products

Lock'N-Pin 3/4" Pedestal Packages

Includes Brushed aluminum post, black E-coated seat mount with Spring & Base Plate.

Description	Post	Base 7"x7"	ABYC Code	Post	Seat Mount	Base Plate	OEM Part #	Part #
Non-Threaded	11"	SS Base Plate	B	2114	1002	67739	—	97739
Threaded	11"	SS Base Plate	B	2114-T	1002	67739-T	—	97739-T
Threaded	13"	SS Base Plate	B	2134-T	1002	67739-T	—	977339-T
Brushed Aluminum Finish Kit, Non-Threaded	11"	Aluminum Base Plate	B	2114	1002	67749	—	97749-7
Camouflage Finish Kit, Non-Threaded	11"	Aluminum Base Plate	B	2114	1002	67749	—	97749C-7



97749-7

97749C-7

Lock'N-Pin 3/4" Pin Seat Mounts

Description	Tilt	Pin	ABYC Code	Installed Height	OEM Part #	Part #
Zinc-plated	3°	2-3/4" Steel Pin w / Spring	B	2"	—	SP-1002
Black E-Coated	3°	2-3/4" Steel Pin w / Spring	B	2"	1002	—
Black E-Coated	3°	2-1/2" Steel Pin	B	1"	1002-S	—
All Stainless Steel	3°	2-3/4" Stainless Steel Pin	B	1"	1002-SS	—

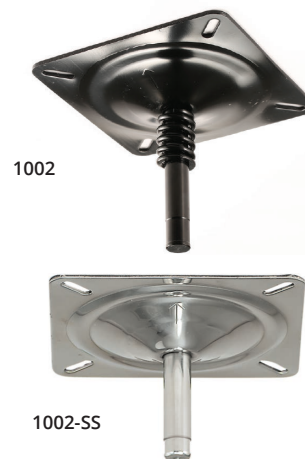

1002

1002-SS

075 Pedestal Kits

Take the confusion out of buying pedestals with these convenient 3/4" pin kits. Kits include seat mount, post and 7" x 7" base. Simply choose the appropriate post height and finish. Attwood's 3/4" pin kit is corrosion resistant, features a 360 degree swivel, a shock absorbing spring, and a removable pin post. Lock 'N' Pin technology features an all steel pin, increasing pedestal strength and durability. Available in brushed aluminum or Realtree MAX-4 camouflage.

Description	ABYC Code	OEM Part #	Part #
Base Plate: 7" x 7", Seat Mount 5-1/4" X 5-1/4" on Center			
Add 3" to post height to get total height, measured from deck to seat			
13" Brushed Aluminum Post	B	—	97750-7
13" Realtree MAX-4 Camouflage Post	B	—	97750C-7

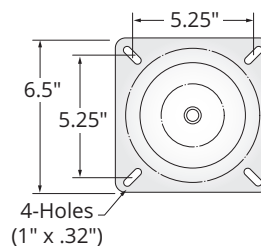

B (Not to be used at the helm/driver position)

See page 180 for ABYC Requirements

Lock'N-Pin 3/4" Pin Posts

Height	Dia	Pin	ABYC Code	OEM Part #	Part #
Fixed Height Posts					
6"	1.5"	Brushed Aluminum Non-Threaded, Steel Pin	B	2064	—
11"	1.5"	Brushed Aluminum Non-Threaded, Steel Pin	B	2114	SP-2114
11"	1.5"	Brushed Aluminum Threaded, Steel Pin	B	2114-T	SP-2114-T
13"	1.5"	Brushed Aluminum Non-Threaded, Steel Pin	B	2134	SP-2134
13"	1.5"	Brushed Aluminum Threaded, Steel Pin	B	2134-T	SP-2134-T
13"	1.5"	Brushed Aluminum Non-Threaded, SS Pin	B	2134-SS	—
13"	1.5"	Brushed Aluminum Threaded, SS Pin	B	2134-T-SS	—
13"	1.5"	Polished SS Offset Post 6", Threaded, SS Pin	B	7153-T-SS	SP-7153-T-SS
16"	1.5"	Brushed Aluminum Non-Threaded, Steel Pin	B	2164	SP-2164
16"	1.5"	Brushed Aluminum Threaded, Steel Pin	B	2164-T	SP-2164-T
24"	1.5"	Brushed Aluminum Pro-Post, Non-Threaded, Steel Pin	B	2244	SP-2244
Adjustable Height Posts - Manual					
25"-31"	1.5"	Brushed Aluminum Pro-Post, Non-Thread, Steel Pin	B	2244-ADJ	SP-2244-ADJ
25"-31"	1.5"	Brushed Aluminum Pro-Post, Threaded, Steel Pin	B	2244-ADJ-T	SP-2244-ADJ-T
Adjustable Height Posts - Power Pedestals with Integral Seat Mounts					
14"-17"	1.77"	Brushed Aluminum Non-Threaded, Steel Pin	B	3004	SP-3004
14"-17"	1.77"	Brushed Aluminum Threaded, Steel Pin	B	3004-T	SP-3004-T
24"-30"	1.77"	Brushed Aluminum Pro-Post, Non-Thread., Steel Pin	B	3204	SP-3204
24"-30"	1.77"	Brushed Aluminum Pro-Post, Threaded, Steel Pin	B	3204-T	SP-3204-T
24"-30"	1.77"	Brushed Aluminum Pro-Post, Threaded, SS Pin	B	3204-T-SS	—
Adjustable Height Posts - Power Pedestals for Use with 3/4" Pin Seat Mounts					
15"-18"	1.77"	Brushed Aluminum Non-Threaded, Steel Pin	B	3004-R	SP-3004-R
15"-18"	1.77"	Brushed Aluminum Threaded, Steel Pin	B	3004-R-T	SP-3004-R-T
15"-18"	1.77"	Brushed Aluminum Threaded, SS Pin	B	3004-R-T-SS	—
24"-30"	1.77"	Brushed Aluminum Non-Threaded, Steel Pin	B	3204-R	SP-3204-R
24"-30"	1.77"	Brushed Aluminum Threaded, Steel Pin	B	3204-R-T	SP-3204-R-T
24"-30"	1.77"	Brushed Aluminum Threaded, SS Pin	B	3204-R-T-SS	—



2114-T

2114

7153-T-SS

3204-T

3004-R

2134-SS

2244-ADJ-T

B (Not to be used at the helm/driver position)

See page 180 for ABYC Requirements

Lock'N-Pin 3/4" Pin Bases

Description	Bushing	ABYC Code	Req. Dia. Mounting Hole	Depth Below Deck	OEM Part #	Part #	
Zinc Plated Steel							
6" x 8"	Non-Threaded	Bronze	B	2.75"	2.5"	6682	—
6" x 8"	Threaded	Bronze	B	2.75"	3.5"	6682-T	—
7" x 7"	Non-Threaded	Acetal	B	2.75"	2.5"	67729	—
7" x 7"	Threaded	Acetal	B	2.75"	3.5"	67729-T	SP-67739-T
Aluminum							
7" x 7", Clear Coat	Non-Threaded	Acetal	B	3.5"	2.5"	67749	SP-67749
Stainless Steel Finish with Steel Lip Tube							
3" x 4"	Non-Threaded	Acetal	B	1.5"	2.5"	63439	—
4" x 8"	Non-Threaded	Acetal	B	1.5"	2.5"	64839	SP-64839
4" x 8"	Non-Threaded	Bronze	B	1.5"	2.5"	6483	—
4" x 8"	Threaded	Bronze	B	1.5"	3.7"	6483-T	—
6" x 8"	Non-Threaded	Acetal	B	2.75"	2.5"	66839	SP-66839
6" x 8"	Threaded	Bronze	B	2.75"	3.7"	6683-T	—
6" x 12", Dual Socket	Threaded	Bronze	B	2.75"	3.7"	66123-T	—
7" x 7",	Non-Threaded	Acetal	B	2.75"	2.5"	67739	SP-67739
7" x 7",	Non-Threaded	Bronze	B	2.75"	2.5"	6773	—
7" x 7",	Threaded	Bronze	B	2.75"	3.5"	6773-T	—
7" x 7", Unfinished	Threaded	Bronze	B	2.75"	3.7"	6773-T-U	—
7" x 7", Offset Hole	Non-Threaded	Acetal	B	2.75"	2.5"	67739-SC	—
All Stainless Steel							
4" x 4"	Non-Threaded	Acetal	B	1.5"	2.5"	64439-SS	—
4" x 4", Polished	Threaded	Bronze	B	2.75"	3.7"	6443-T-P-SS	—
7" x 7"	Non-Threaded	Acetal	B	2.75"	2.5"	67739-SS	—

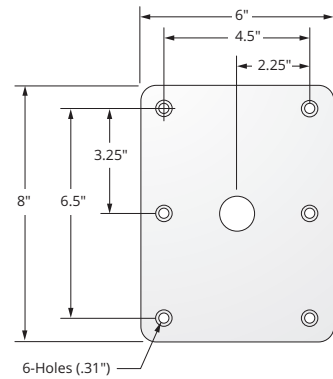
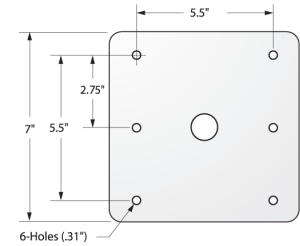

67729



67739-SC



67749

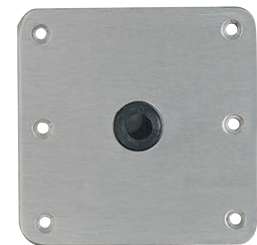

67739-SS



66839



67739



64839

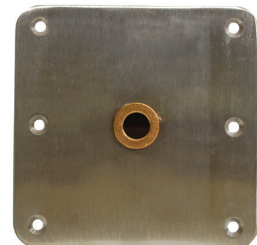

6773

B (Not to be used at the helm/driver position)

See page 180 for ABYC Requirements

Pedestals, Swivels & Adapters

We have the boating experience to deliver all the accessories you want:

Seating accessories for retrofitting and improving

- Adapters to change a post installation or swivel location
- Table mounts to make boating more convenient and enjoyable

Pedestals

Little on price, big on performance

- Exceptional durability
- Reinforced welded joints
- Black powder coated for a long lasting finish

Description	OEM Part #	Part #
Pedestal, 7"	—	90720
Pedestal, 13"	—	91320
Adjustable Pedestal, 11-1/2" - 17-1/2"	—	91320-ADJ



90720



91320



91320-ADJ

Seat Swivels

Description	OEM Part #	Part #
Zinc Plated, 0° Tilt, 4-Way Locking	1872	—
Black Powder Coated, 0° Tilt, 6-1/4" (10 p/Box)	—	17720
Black Powder Coated, 3° Tilt, 7" (10 p/Box)	—	17721



17720

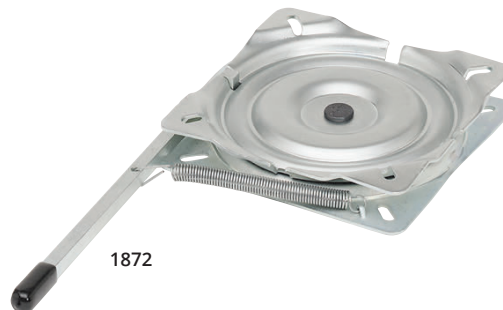

1872

Seat Mounts

Bench Style Seat Mounts

- Great for mounting seats in jon boats
- Constructed of quality aluminum.

Clamp-On Boat Seat Swivel

- Adjusts from 7-1/2" to 18"
- Black powder coated swivel
- Fits most seat hole patterns

Description	OEM Part #	Part #
Bench Style Seat Mounts		
Bench Style Kit: Seat Plate an 15" Rails	—	SP-15900
Bench Style Seat Plate Only	—	SP-15100
Bench Style 30" Rails Only	—	SP-15200
Clamp-On Boat Swivel		
Boat Swivel	—	15700-3



SP-15900



15700

Quick Disconnect Seat Mount

Allows for easy attachment and removal of boat seats for ease in storage and care. Produced from durable engineered plastic and coated structural steel frame for years of use. Easy to install and use, mounts directly to existing seats and standard pedestals. Perfect for Jon boats, fishing boats, pontoons and more.

Description	OEM Part #	Part #
Fits 6-1/4" (15.9 cm) swivel and plates	—	11602D1
Fits 7" (17.8 cm) swivel and plates	—	11603D1



11602D1



111603D1

Deck Slide

- Mounts directly to the boat deck
- 1-5/8" total height
- Constructed of strong aluminum
- Convenient front control operation

Description	OEM Part #	Part #
Deck Mounted Seat Slide	815000	—



815000

Seat Swivel Offset

Need more room to maneuver? The 6" offset allows additional seat clearance in any position.

Description	OEM Part #	Part #
Seat Swivel Offset	—	7062-3



Table Top Mount System

Description	OEM Part #	Part #
Brushed aluminum post with tension knob. Threaded for use in base. 25"	17525	—
6" diameter round stainless steel base, threaded Flush mounts to deck. Low profile	—	952



Pedestal Pin Post Adapter

Converts 1.77" bases to accept 3/4" posts

Description	OEM Part #	Part #
Adapter	—	SP-14000



SP-14000

Part #	Page	Part #	Page	Part #	Page	Part #	Page	Part #	Page
278AOP0912-BD-1	193	11254-1	150	11635-4	127	11733-7	110	117681-7	110
278AOP1215-1	193	11282-3	151	11654-3	127	11734-1	109	11768-2	137
278AOP1519-1	193	11283-3	151	5091-10-1	51	11736-7	109	117684-7	111
278AOP1923-1	193	11284-3	151	5091-10-7	51	11737-7	111	5122-08-7	64
66308-1	34	11285-3	151	5091-12-1	51	11739-2	114	11772-1	137
1001667	22	11315-1	149	5092-10-7	51	11739-2	148	11775-5	140
1001668	22	11317-1	149	11664-3	95	11741-7	109	11776-5	140
1002	200	11319-1	149	11670-4	127	11742-7	109	11778-2	140
1002-S	200	11360-1	150	5095-10-7	51	11749-7	111	11780-6	139
1002-SS	200	11361-1	150	11672-4	127	11750-7	111	11783-7	141
001008199	80	11362-1	150	5098-10-1	51	117525-7	111	11786B-1	127
001008200	80	11363-1	150	11700-2	113	11752-7	111	11786B-7	127
10107	153	11364-1	150	11701-7	110	11753-7	114	11786W-1	127
10108	153	11368-3	151	11702-7	111	117553-7	104	11786W-7	127
001011094	80	11370-1	151	11703-7	111	117553-7	113	11787-1	127
10309	153	11370-7	122	11704-2	113	117561-2	114	11788-1	127
11011-7	146	11371-1	151	11705-7	110	11756-2	138	11789-1	127
11029-6	145	11372-1	151	11706-7	110	117563-7	110	11789WD1	127
11090-3	151	11401-4	146	11707-7	109	117564-7	110	11792-6	114
11126-4	146	11404-6	169	11708-1	109	117565-7	111	11794-7	124
11127-4	146	11437-7	142	11709-1	109	117566-7	111	11807-2	122
11130-7	146	11438-7	142	11710-2	113	117567-7	111	11808-2	140
11147-7	148	11441-4	142	11711-7	110	11757-2	138	118089-7	124
11149-4	147	11446-1	35	11712-7	114	11758-2	138	118092-7	124
11150-5	107	11477-3	124	11713-2	113	11759-1	137	11820-7	94
11180-5	107	11478-7	124	11714-2	109	11760-1	137	11822-6	82
11195-4	147	11512-3	93	11715-7	110	117601-7	110	11823-6	82
11200-1	149	11524-1	33	11716-1	109	117603-7	110	11824-6	82
11201-1	149	11524-3	33	11717-2	113	117604-7	110	11826-1	125
11202-1	149	11526-3	93	11718-2	113	117605-7	110	11826-1	139
11205-1	149	11551-5	25	11719-2	113	117607-7	110	11828-1	125
11209-1	149	11575-3	107	11720-2	113	117608-7	110	11828-1	139
11210-1	149	11586-4	35	11721-2	113	11761-1	137	11829-6	125
11211-1	149	11591-3	35	11722-2	109	117614-7	111	11830-2	125
11215-1	150	11592-3	35	11723-7	109	117617-7	111	11834-1	128
11216-1	150	11595-2	24	11724-1	109	11762-1	137	11840-7	94
11217-1	150	11595-2	140	11725-2	109	117621-7	111	11841-4	94
11220-3	150	11596-2	24	11726-2	113	11763-1	137	11843-7	112
11230-1	150	11596-2	140	11728-2	111	11764-1	137	11845-1	127
11246-1	151	11602D1	204	11729D5	112	11765-1	137	11848-4	117
11247-1	151	11603D1	204	11730-7	111	11766-1	137	11849-2	128
11252-1	150	11631-4	127	11732-7	112	117680-7	110	11851-2	128

Part #	Page	Part #	Page	Part #	Page	Part #	Page	Part #	Page
11857-1	149	12114-1	160	13065-4	126	1425-1	38	1495-1	38
11861-6	134	12115L3	160	13066-7	126	14253-3	134	1495A1	38
11862-6	134	12120-1	160	1329-1	168	1425-5	38	1495B1	38
11865-4	123	12121-3	160	1341-1	38	14255-3	134	1495B5	38
11866-6	125	12124-1	160	1342-1	38	14258-6	132	1499-1	37
11871-7	122	12125-3	160	1343-1	37	14258B1	132	1499-5	37
11873-1	94	12126-1	160	1345-1	38	14258R1	132	15221-7	153
11875-7	125	12127-3	160	1348-1	39	1426-1	38	15232-7	153
11880-1	149	12303-3	163	1353-1	39	1426-5	38	15700-3	204
11881-1	149	12305-3	163	1364A1	39	14348-6	133	1607-1	99
11889D1	125	12355-3	163	1364A3	39	14350-3	135	1607-3	99
11891D7	95	12357-3	163	13700-7	104	14352-3	135	16205-2	95
11894-2	128	12412-1	163	13702-4	104	14361-5	136	16207-2	95
11896-1	128	12415L3	163	13710-4	104	14365-6	135	16208-7	95
11897-2	128	12460-1	170	13753-7	104	14366-6	135	1670-1	88
11900-4	132	12461-3	170	1405-1	39	14367-6	135	1670-3	88
11901-4	132	12562-6	94	1405-3	39	14370-6	136	1674-1	88
11909-7	139	12701-5	120	14060-7	144	14371-6	136	1674-6	88
11912-5	139	12703D1	120	14063-7	144	14372-7	136	17209-1	34
11926-7	141	12704-1	120	14064-7	144	1438F1	39	17211-3	34
11930-4	143	12708-2	120	14065-7	144	1439F1	39	1731-1	36
11944-7	139	12750-6	121	14066-7	145	14509-6	82	1731-4	36
11950-6	141	12760-7	120	14133-6	145	14509-6	82	1733-1	36
11951-6	141	12761-7	121	14137-7	128	14530-6	82	1733-4	36
11952-7	107	12772-2	121	14141-7	123	14532-6	82	1747-1	36
11953-4	143	12773-2	121	14142-7	123	14540-6	82	1747-4	36
11964-1	103	12774-2	121	14185XFS-7	67	14580-1	93	1749-1	36
11966-1	103	12790-1	140	14187XFS-7	67	14582-1	93	1749-4	36
11968-1	103	12790-1	170	14190-7	67	14584D1	93	1751-1	36
11969-4	103	12790-3	140	14191-7	67	14584D1	122	17525	205
11971-7	112	12790-3	170	14192-7	67	1476-1	119	17720	203
12009-3	160	12791-1	140	14193-7	67	1477-1	119	17721	203
12044-6	145	12791-1	170	14194-7	67	1478-1	119	1872	203
12048-4	107	12792-1	140	14195-7	67	1478W1	119	2012A1	169
12049-4	107	12792-1	170	14196-7	67	1487A1	37	2012A3	169
12100L3	160	12794-1	140	14197-7	67	1488-1	37	2027-1	170
12102-1	160	12794-1	170	14215-6	132	1488-5	37	2027-7	170
12102L3	160	12820-5	93	14230-3	133	1493-1	37	2028-1	170
12110-1	160	12891L3	163	1423-1	38	1493-5	37	2050-1	171
12111L3	160	12988-1	141	14233-7	133	1494A1	38	2050-5	171
12112-1	160	12988-1	166	14234-7	133	1494A5	38	2053-1	171
12113L3	160	13055-4	126	1423-5	38	1494F1	38	2053-5	171

Part #	Page	Part #	Page	Part #	Page	Part #	Page	Part #	Page
2054-1	171	238322-1	198	2445-7	127	3396-1	163	3886-3	33
2054-5	171	238333-1	196	2449-1	127	3396-3	163	3888-1	34
2061-1	171	238333-1	198	2449-7	127	3810-1	47	3889-1	34
2061-5	171	238352-1	196	2460-1	124	3810-7	47	3890-1	27
2064	201	238352-1	198	2460-7	124	3820-1	47	3890-3	27
2080-1	171	238512-1	196	2520-1	52	3820G7	47	3891-1	27
2114	201	238512-4	196	2530-1	52	3820R7	47	3892-1	27
2114-T	201	238522-1	196	2638-1	123	3830-1	48	3893-1	27
2134	201	238522-4	196	278ANZPM-1	193	3838-1	48	3896-1	32
2134-SS	201	2385400	198	278AO3AGL-1	193	3838G7	48	3896-3	32
2134-T	201	2385405	198	278AO3AGS-1	193	3838R7	48	3899-1	27
2134-T-SS	201	238608-1	196	278AO3AM-1	193	3845-1	32	3899-3	27
2164	201	238609-1	196	278AO3PGL-1	193	3870-1	32	3900-1	27
2164-T	201	238610-1	196	278AO3PM-1	193	3872-1	32	3902-1	27
2244	201	238610-3	196	278AOGY060-1	193	3872-3	32	3902-3	27
2244-ADJ	201	238610L1	197	278AOGY070-1	193	3872A1	32	3909-1	27
2244-ADJ-T	201	238611-1	196	278AOGY080-1	193	3873-1	32	4000-ADJ	152
238027-1	196	238611L1	197	278AOGY090-1	193	3873-3	32	4000-ADJ-B	152
238027-3	196	238612-1	196	278AOGY100-1	193	3873A1	32	400-B	152
23809-7	195	238612-3	196	278AOGY110-1	193	3874-1	32	400-R	152
23811-7	195	238613-1	196	278AOGY120-1	193	3874-3	32	4116-5	25
23813-7	195	238613-3	196	278AOGY130-1	193	3874A1	32	4118A1	26
238141-1	195	238613L1	197	278AOZAGL-1	193	3875-1	32	4118A5	26
238142-1	195	238614-1	196	278AOZAGS-1	193	3875-3	32	4121-1	26
238142-7	195	238615-1	196	278AOZAM-1	193	3875A1	32	4121-3	26
238150-1	195	238615-3	196	278AOZPGL-1	193	3875B1	32	4122-1	26
238151-1	195	238617-1	196	278AOZPM-1	193	3875C1	34	4122-3	26
238152-1	195	238625-1	196	3004	201	3876-1	33	4123-1	26
238152-7	195	238630-1	196	3004-R	201	3876-3	33	4125-1	26
238153-1	195	238630L1	196	3004-R-T	201	3877-1	32	4125-7	26
238153-7	195	238813LSM1	198	3004-R-T-SS	201	3877-3	32	4131-1	23
23815-7	195	238833LSM1	198	3004-T	201	3878-1	32	4131-4	23
238162-1	195	238908-1	196	3204	201	3878-3	32	4133-1	23
238162-4	195	238909LSM1	198	3204-R	201	3879-1	32	4140-4	24
238164-1	195	238911-1	196	3204-R-T	201	3879-3	32	4141-1	22
238300-1	196	238911L1	198	3204-R-T-SS	201	3880-1	32	4141-4	22
238300-1	198	238912-1	196	3204-T	201	3881-1	33	4142-1	22
238312-1	196	238913-1	196	3204-T-SS	201	3881Kit-1	33	4143-1	22
238312-1	198	238913L1	198	3300-1	73	3882-1	34	4143-4	22
238312-2	196	238913LSM1	198	3325-3	161	3885-1	33	4144-1	22
238312-2	198	238915-1	196	3392-1	163	3885-3	33	4145-1	22
238322-1	196	238916LSM1	198	3392-3	163	3886-1	33	4199-7	25

Part #	Page	Part #	Page	Part #	Page	Part #	Page	Part #	Page
4201-1	21	4670-7	19	5092-16T1	51	5351-P12-1	63	5540-54T1	55
4201-7	21	4672-1	19	5092-20T1	51	5358-P12-7	63	5540-60T1	55
4202-1	21	4672-7	19	5095-10T1	51	5505-1	12	5540-72T1	55
4202-7	21	4730-1	15	5100-24-1	58	5505-2	12	5540-84T1	55
4232-1	33	4730-4	15	5100-36-1	58	5505-7	12	5550-12Z1	62
4232-7	33	4760-1	15	5100-48-1	58	5508-1	12	5550-24Z1	62
4236	14	4760-4	15	5100-54-1	58	5508-2	12	5550-30Z1	62
4236	14	4770-1	15	5110-24-7	58	5508-7	12	5550-36Z1	62
4236	14	4770-4	15	5110-30-7	58	5509-1	12	5550-P12-1	62
424-ADJ	152	4801-1	20	5110-36-7	58	5509-2	12	5550-P20-1	62
4253-7	25	4801-7	20	5110-42-7	58	5509-7	12	5550-P24-1	62
436-ADJ	152	5009-4	115	5110-48-7	58	5512-1	12	5550-PA20-7	62
4505-1	14	5009W4	115	5110-54-7	58	5512-2	12	5550-S12-1	62
4505-7	14	5010-4	115	5300-60-1	57	5512-7	12	5550-S18-1	62
4505S1	14	5011-7	116	5300-72-1	57	5513-1	12	5550-S24-1	62
4507-1	14	5012-7	116	5310-66T1	57	5513-2	12	5550-S30-1	62
4507-7	14	5014-4	115	5320-20T1	57	5513-7	12	5550-S36-1	62
4507S1	14	5016-3	116	5320-42T1	57	5530-12T1	54	5550-S42-1	62
4508-1	14	5022-7	116	5320-48T1	57	5530-24A7	54	5551-P12-1	62
4511-1	14	5030-4	116	5320-54T1	57	5530-24BP1	54	5551-PA20-7	62
4511-7	14	5031D1	117	5320-54TB1	57	5530-24BP7	54	5557-P12A7	62
4511S1	14	5040-1	46	5320-60T1	57	5530-30BP1	54	5558-P12A7	62
4512-1	14	5040G7	46	5320-60TB1	57	5530-36A7	54	5570-60-1	55
460-ADJ	152	5040R7	46	5320-72T1	57	5530-36BP1	54	5570-72-1	55
4614-7	25	5045-7	46	5330-42-7	56	5530-36BP7	54	5580-03	64
4620-6	18	5060-3	118	5330-42T1	56	5530-42A7	54	5580-1	64
4622-6	18	5061-3	118	5330-48-7	56	5530-42BP1	54	5580A7	64
4622-6	19	5062-3	118	5330-54T1	56	5530-42BP7	54	5581-1	64
4624-6	18	5063-3	118	5330-60T1	56	5530-42T1	54	5582-1	64
4640-1	18	5070-3	118	5330-72T1	56	5530-48A7	54	5606-1	16
4640-7	18	5071-3	118	5340-42T1	56	5530-48BP1	54	5606-7	16
4641-1	18	5072-7	118	5340-48T1	56	5530-48T1	54	5606B-1	16
4643-1	18	5074-3	118	5340-54-7	56	5530-54A7	54	5608-1	16
4643-7	18	5080G7	46	5340-54T1	56	5530-54BP1	54	5608-7	16
4650-1	18	5080R7	46	5340-60T1	56	5530-54BP7	54	5608B-1	16
4650-7	18	5091-14-1	51	5340-72T1	56	5530-54T1	54	5609-1	16
4651-1	18	5091-14-7	51	5340-84T1	56	5530-54TB1	54	5609-7	16
4660-1	18	5092-10T1	51	5350-24Z1	63	5530-60A7	54	5609B-1	16
4660-7	18	5092-12T1	51	5350-30Z1	63	5530-60BP1	54	5610-48-7	58
4661-1	18	5092-12TB1	51	5350-36Z1	63	5530-60T1	54	5612-1	16
4663-1	18	5092-14-7	51	5350-PA12-7	63	5530-66T1	54	5612-7	16
4670-1	19	5092-14T1	51	5350-PA20-7	63	5540-54A7	55	5612B-1	16

Part #	Page	Part #	Page	Part #	Page	Part #	Page	Part #	Page
5613-1	16	6443-T-P-SS	202	66023-1	99	66261L3	163	66502-1	159
5613-7	16	6450-1	120	66025-1	167	66262-1	163	66510-1	157
5613B-1	16	6451-1	120	66027-1	168	66263-1	163	66510-7	157
5940-1	64	6451-7	120	66027-3	168	66308-3	34	66512-1	157
5940-7	64	6483	202	66028-1	168	66318-7	49	66514-1	157
5980-1	64	64839	202	66029-1	168	66319G7	49	66514-7	157
6115-1	26	6483-T	202	66029-3	168	66319R7	49	66515-1	156
6244-1	160	6521SS1	68	66031-1	99	66334-1	158	66515-7	156
6244-6	160	6522SS1	68	66031-3	99	66335-1	158	66516-1	157
6245-1	160	6522SS7	68	66032-1	99	66336-1	158	66516-7	157
6245-6	160	6523BK1	68	66032-3	99	66362-1	119	66517-1	156
6260-4	146	6523BK7	68	66054-1	158	66362-7	119	66517-7	156
6317-1	72	6556-1	66	66055-1	158	66362W1	119	66519-1	156
6319-1	72	6556-7	66	66056-1	158	66362W7	119	66522-1	157
6320B1	71	65UW03B-1	70	66060-1	98	66363-1	119	66524-1	157
6320W1	71	65UW03B-7	70	66060-1	98	66363-7	119	66529-1	156
6320W7	71	65UW03CVSS-1	70	66061-3	98	66363W1	119	66531-1	156
6321B1	71	65UW03G-1	70	66061-3	98	66363W7	119	66533-1	156
6323W1	71	65UW03G-7	70	66062-1	158	66364-1	119	66538-1	156
6323W7	71	65UW03W-1	70	66063-1	158	66364-7	119	66540-1	28
6340SS1	71	65UW03W-7	70	66064-1	158	66364W1	119	66540-3	28
6340SS7	71	65UW06B-1	70	66074-3	98	66364W7	119	66541-1	28
6341SS7	71	65UW06B-7	70	66104-1	166	66398-1	159	66541-3	28
6342SS1	71	65UW06CVSS-1	70	66105-1	141	66399-1	39	66542-1	28
6342SS7	71	65UW06G-1	70	66105-1	166	66399-3	39	66542-3	28
63439	202	65UW06G-7	70	66110-1	159	66400-1	39	66543-1	28
6343SS7	71	65UW06W-1	70	66110-3	159	66400-3	39	66543-3	28
6344SS1	71	65UW06W-7	70	66111-1	159	66406-5	98	66544-1	28
6346SS1	71	65UW12B-1	70	66111-3	159	66408C1	98	66544-3	28
6348SS1	71	65UW12B-7	70	66112-1	159	66411C1	98	66545-1	28
6350B1	72	65UW12CVSS-1	70	66120-1	161	66412C1	98	66545-3	28
6350B7	72	65UW12W-7	70	66123-T	202	66419-1	88	66546-1	28
6350W1	72	65UW12W-7	70	66126C1	98	66419-3	88	66546-3	28
6350W7	72	66004-1	99	66163-1	168	66423-1	169	66547-1	28
6351B1	72	66008-1	162	66202-3	166	66434-1	167	66547-3	28
6351G1	72	66009-1	159	66223-1	162	66446C1	98	66548-1	28
6351W1	72	66009L6	159	66223-3	162	66448-1	164	66548-3	28
6353W7	72	66010-1	159	66224-1	162	66449-1	164	66549-1	28
6354W7	72	66010L3	159	66239-1	167	66470-1	119	66549-3	28
6355W7	72	66011-1	159	66239-3	167	66470-7	119	66550-1	28
6375D6	49	66011-3	159	66240-1	167	66471-1	119	66550-3	28
64439-SS	202	66012-1	159	66261-1	163	66471-7	119	66551-1	28

Part #	Page	Part #	Page	Part #	Page	Part #	Page	Part #	Page
66551-3	28	67557-1	30	7520PD2	35	7812-S-1	65	88FBMA102-6	82
66552-1	28	67558-1	30	7524A1	35	7812-S-7	65	88FHE516-6	82
66553-1	29	67561-1	30	7524A7	35	7812Z1	65	88FHY516-6	82
66553-3	29	67562-1	30	7524B1	35	7824-S-1	65	88FTS014-6	82
66553Kit	29	67580-1	30	7524D1	35	7836-S-1	65	88FV200-6	82
66555-1	29	67581-1	30	7524PD2	35	7842-S-1	65	88TC06-7	93
66555Kit	29	67582-1	30	7524PD2	35	8043-3	123	8900-6	82
66557-1	29	67583-1	30	7526A1	35	815000	204	8901-6	82
66559-1	29	67729	202	7526A7	35	818440	197	8902-6	82
66561-1	29	67729-T	202	7526D1	35	818441	197	8M0044687	79
66563-1	29	6773	202	7526D2	35	818441-3	197	9006-1	131
66565-1	29	67739	202	7526PD1	35	828461	197	9013-1	131
66567-1	29	67739-SC	202	7532A3	35	8315-4	123	9013-3	131
66577-1	29	67739-SS	202	7533A1	35	8803LP2	77	9013A3	131
66579-1	29	6773-T	202	7533A7	35	8803LP2S	77	9014-1	131
66586-1	157	6773-T-U	202	7533PD2	35	8803LPG2	77	9014-3	131
66588-1	157	67749	202	7533PD2	35	8803LPG2S	77	9014A1	131
66589-1	157	68551-1	31	7534A1	35	8806LP2	77	9014A3	131
66617-1	156	68554-1	31	7534A3	35	8806LP2S	77	9015-1	129
6682	202	68555-1	31	7555-1	34	8806LPG2	77	9015-3	129
6682-T	202	68556-1	31	7555-3	34	8806LPG2S	77	9016-1	129
66832-1	169	68557-1	31	7557-1	34	8812LLP2	77	9016-3	129
66839	202	68576-1	31	7557-7	34	8812LLPG2	77	903-008-T-S	165
6683-T	202	68577-1	31	7557G1	34	8812LP2	77	903-009-S	165
66970-7	120	68578-1	31	7563-1	134	8812LPG2	77	9065-1	130
66HR09-1	171	68579-1	31	7563-6	134	8838HF6	80	9067-1	130
66HRD12-1	171	68581-1	31	7566AR1	35	8838HM6	80	9069-1	130
66UW03B-7	70	7006-1	190	7566BG1	35	8838TM6	80	9070-1	129
66UW06B-1	70	7009-1	190	7571-1	73	8838US6	80	9070-7	129
66UW06B-7	70	7040-1	188	7571L7	73	8873-6	82	90720	203
66UW06G-1	70	7060-1	188	7591-6	134	8882-6	82	9076-1	130
66UW06W-1	70	7062-3	205	7594-1	134	8883-6	82	9082-1	130
66UW12B-1	70	7100A7	58	7594-3	134	8884-6	82	9083-7	126
66UW12B-7	70	7100B7	58	7621-7	145	8887-6	82	9084-1	130
66UW12W-1	70	7100C7	58	7622-7	135	8889LP6	82	9090-1	131
66UW12W-7	70	7153-T-SS	201	7623-7	136	8890LP6	82	9090-5	131
67551-1	30	7201-P-7	65	7640-3	163	8896LP6	82	9091-1	131
67552-1	30	7202-P-7	65	7647-7	135	8896LP6	82	9091-5	131
67553-1	30	7518A3	35	7648-7	135	8897-6	82	9092-5	131
67554-1	30	7518PD2	35	7651-3	163	88FAS014-6	82	9093-5	131
67555-1	30	7520A1	35	7653L3	163	88FAS038-6	82	9094-1	131
67556-1	30	7520A3	35	7663-5	145	88FBM101-6	82	9094-5	131

Part #	Page	Part #	Page	Part #	Page	Part #	Page	Part #	Page
9095-1	131	911490-1	61	9372-2	95	97749C-7	200	99202AWS1	97
9095-5	131	911507-1	88	93806AUS7	81	97750-7	200	99202AWSY1-1	97
9096-1	131	911508-1	88	93806EI7	96	97750C-7	200	99202WS1	97
9096-5	131	911526-1	88	93806ELP7	81	98100-1	190	99202WZ1	97
9097-1	131	911528-1	88	93806EUS7	81	98120-1	190	99210GB1	97
9097-5	131	91320	203	93806EUSD7	81	98124	190	99211GB1	97
9098-1	131	91320-ADJ	203	93806HUS7	81	98201-1	188	9933-1	102
9098-5	131	913670-1	62	93806MI7	96	98202-1	188	9933B1	102
9099-1	131	913670-1	63	93806MUS7	81	98203-1	188	9934-1	102
9099-5	131	913670-1	65	93806MUSD7	81	98204-1	188	9934B1	102
91022-1	61	913671-1	62	93806UFDV7	81	98390GY	186	9935-1	102
91022-7	61	913671-1	63	93806UI7	96	98391GNMX	185	9935B1	102
910R2PB-1	60	913671-1	65	93806ULP7	81	98391GY	185	9941-1	102
910R2PB-7	60	9146-3	163	93806UUS7	81	98395CAMO	185	9941B1	102
910R2PSB-1	60	9146-6	139	93806UUSD7	81	98395GY	185	9942-1	102
910R2PSB-7	60	9149-6	139	93806YI7	96	98395WH	185	9942B1	102
910R2PSW-1	60	9185J1	27	93806YLP7	81	9842-1	34	9943-1	102
910R3PB-1	60	922-ADJ-S	165	93806YUS7	81	9842-3	34	9943B1	102
910R3PB-7	60	923-009	165	93812ULP7	81	9842PD1	34	9944-1	102
910R3PSB-1	60	923-009-ADJ	165	93812UUS7	81	9844PD2	34	9944B1	102
910R3PSB-7	60	9300FDV7	79	93812UUSD7	81	98505CA	186	9945B1	102
910T2PB-1	60	93014LP7	78	9400-7	95	98505GY	186	9946-1	102
910T2PB-7	60	93038I7	96	9401-7	95	98505WH	186	9946B1	102
910T2PSB-1	60	93038LP7	78	94100-4	136	98900-1	189	9948-1	102
910T2PSB-7	60	9350-4	104	94110-5	136	98908-1	189	9948B1	102
910T2PSW-1	60	9351-2	104	9433-S	165	98910-1	189	9955-1	103
910T3PB-1	60	93516I7	96	9436-S	165	98961-1	187	9956-1	103
910T3PB-7	60	93516LP7	78	951606ULP7	81	98963-1	187	9957-1	103
910T3PSB-1	60	93531-1	106	952	165	98990-1	187	9960-1	103
910T3PSB-7	60	93532-1	106	952	205	98991-1	187	9961-1	103
910T3PSW-1	60	93533-1	106	96008	165	99200DS1	97	9962-1	103
910V2PB-1	59	93534-1	106	9709-7	117	99200GB1	97	9963-1	103
910V2PB-7	59	93536-1	105	97100-001-1	184	99200GS1	97	99CC035-1	89
910V2SS-1	59	93537-1	106	97100-001-2	184	99200GZ1	97	99CC035HSA1	89
910V2SS-7	59	9354BD1	105	97100-005-1	184	99200WS1	97	99CC045-1	89
910V3PB-1	59	9354D1	105	97100-005-2	184	99200WZ1	97	99CC045-1S	89
910V3PB-7	59	9355BD1	105	97100-006-1	184	99201DS1	97	99CC045H1	89
910V3SS-1	59	9355D1	105	97100-006-2	184	99201GB1	97	99CC045HSA1	89
910V3SS-7	59	9356BD1	105	977339-T	200	99201GS1	97	99CC045V1	89
911339-1	61	9356D1	105	97739	200	99201GZ1	97	99CC085-1	89
911339-7	61	9358-1	105	97739-T	200	99201WS1	97	99CC085-1S	89
911370-1	60	9358B1	105	97749-7	200	99201WZ1	97	99CC085H1	89

Part #	Page	Part #	Page	Part #	Page	Part #	Page	Part #	Page
99CC085HSA1	89	99FLA230-1	92	AS5505S-1	12	NV2002SS-7	45	NV6SP1-16-1	52
99CC085HSA1S	89	99FLA330-1	92	AS5512E-1	12	NV2011PB-1	45	NV6SP2-10-1	50
99CC150-1	89	99FLB080-1	92	AS5512E-1	12	NV2011SS-1	45	NV6SP2-10-1	52
99CC150-1S	89	99FLB100-1	92	AS5512S-1	12	NV2012PB-1	45	NV6SP2-14-1	50
99DFCCAB1	87	99FLB140-1	92	AS5512S-1	12	NV2012PBG-7	45	NV6SP2-14-1	52
99DFCCAB1S	87	99FLB170-1	92	AS5605E-1	16	NV2012PBR-7	45	RH-4646	115
99DFCCAS1	87	99FLB230-1	92	AS5605E-1	16	NV2012SS-1	45	SL10-40-5	173
99DFCCAS1S	87	99FLB330-1	92	AS5605E-1	16	NV2012SSG-7	45	SL10-XX-1	172
99DFCCASY1-1	87	99GVG000-1	92	AS5605S-1	16	NV2012SSR-7	45	SL11-XX-1	172
99DFCCAW1	87	99GVP000-1	92	AS5605S-1	16	NV3011SS-1	45	SL1-20-5	173
99DFCCAZ1	87	99ICV000-1	92	AS5605S-1	16	NV3012SS-1	45	SL13-20-5	173
99DFCCAZ1S	87	99ICV000HS2	92	AS5612E-1	16	NV3012SSG-7	45	SL13-60-5	173
99DFCCCLPAS1	87	99IFDV00-1	90	AS5612E-1	16	NV3012SSR-7	45	SL13-XX-1	172
99DFCCCLPSS1	87	99IFDVHS1	90	AS5612S-1	16	NV4012SS-1	45	SL1-40-5	173
99DFCCS1S	87	99TDF100-1	88	AS5612S-1	16	NV4012SSG-7	45	SL14-20-5	173
99DFCCSB1	87	99TDFPV100-1	91	ATT001	191	NV4012SSR-7	45	SL14-30-5	173
99DFCCSB1S	87	99TDFPV110-1	91	ATT002	191	NV5012PB-1	45	SL14-40-5	173
99DFCCSS1	87	AK5505-7	12	ATT007	191	NV5012SS-1	45	SL14-60-5	173
99DFCCSSY1-1	87	AK5505-7	12	ATT008	191	NV6LC1-10-1	50	SL14-XX-1	172
99DFCCSW1	87	AK5505-7	12	ATT009	191	NV6LC1-10A7	50	SL15-XX-1	172
99DFCCSZ1	87	AK5505-7	12	ATT016	191	NV6LC1-10BP1	50	SL16-30-5	173
99DFCCSZ1S	87	AK5505-7	12	ATT101	188	NV6LC1-12-1	50	SL16-XX-1	172
99DFPVAB1	90	AK5505-7	12	ATT102	188	NV6LC1-12BP1	50	SL1-XX-1	172
99DFPVAB1S	90	AK5512-7	12	ATT103	188	NV6LC1-14-1	50	SL20-XX-1	172
99DFPVAS1	90	AK5512-7	12	ATT109	188	NV6LC1-14-7	50	SL2-40-5	173
99DFPVAS1S	90	AK5512-7	12	ATT110	188	NV6LC1-14A7	50	SL25-XX-1	172
99DFPVASY1-1	90	AK5512-7	12	ATT200-1	189	NV6LC1-14BP1	50	SL26-XX-1	172
99DFPVVAZ1	90	AK5605-7	16	ATT205-1	189	NV6LC1-14BP7	50	SL27-XX-1	172
99DFPVSB1	90	AK5605-7	16	ATT210-1	189	NV6LC1-16-1	50	SL28-XX-1	172
99DFPVSB1S	90	AK5605-7	16	NV1001PB-1	45	NV6LC2-10-1	50	SL29-XX-1	172
99DFPVSS1	90	AK5605-7	16	NV1001SS-1	45	NV6LC2-10-7	50	SL2-XX-1	172
99DFPVSS1S	90	AK5605-7	16	NV1002PB-1	45	NV6LC2-14-1	50	SL30-20-5	173
99DFPVSSY1-1	90	AK5605-7	16	NV1002SS-1	45	NV6LC2-14-7	50	SL30-40-5	173
99DFPVVSZ1	90	AK5612-7	16	NV1011PB-1	45	NV6LC2-14BP1	50	SL30-60-5	173
99DVA02-1	90	AK5612-7	16	NV1011SS-1	45	NV6LC2-14BP7	50	SL30-XX-1	172
99DVB01-1	90	AK5612-7	16	NV1012PB-1	45	NV6SP1-10-1	50	SL31-20-5	173
99DVB02-1	90	AK5612-7	16	NV1012SS-1	45	NV6SP1-10-1	52	SL31-30-5	173
99DVC01-1	90	AS5505E-1	12	NV2001PB-1	45	NV6SP1-12-1	50	SL31-40-5	173
99DVP03-1	90	AS5505E-1	12	NV2001SS-1	45	NV6SP1-12-1	52	SL31-XX-1	172
99DVP05-1	90	AS5505E-1	12	NV2002PB-1	45	NV6SP1-14-1	50	SL32-20-5	173
99FLA140-1	92	AS5505S-1	12	NV2002PB-7	45	NV6SP1-14-1	52	SL32-30-5	173
99FLA170-1	92	AS5505S-1	12	NV2002SS-1	45	NV6SP1-16-1	50	SL32-XX-1	172

Part #	Page	Part #	Page	Part #	Page	Part #	Page	Part #	Page
SL33-20-5	173	SL44SSP3-1	175	SL70-BS-1	174	SP-436-ADJ-RB	152	ST33-60-5	173
SL33-30-5	173	SL46SSP3-1	175	SL72SSBS-1	177	SP-64839	202	ST33-XX-1	172
SL33-40-5	173	SL46SSP3R-1	175	SL74SSBS-1	174	SP-66839	202	ST34-120-5	173
SL33-50-5	173	SL48BP3R-1	175	SL75-SSBS-1	174	SP-67739	202	ST34-20-5	173
SL33-60-5	173	SL48P3-1	175	SL76SSP3-1	177	SP-67739-T	202	ST34-30-5	173
SL33-XX-1	172	SL48P3R-1	175	SL76SSP3R-1	177	SP-67749	202	ST34-40-5	173
SL34-120-5	173	SL48SSP3-1	175	SL77P3-1	177	SP-68914	199	ST34-50-5	173
SL34-20-5	173	SL4-XX-1	172	SP-1002	200	SP-7153-T-SS	201	ST34-60-5	173
SL34-30-5	173	SL50BP3-1	175	SP-14000	205	SP-910	165	ST34-80-5	173
SL34-40-5	173	SL50P3-1	175	SP-15100	204	SP-923-009-ADJ	165	ST34-90-5	173
SL34-50-5	173	SL50P3R-1	175	SP-15200	204	SP-96008	165	ST34-XX-1	172
SL34-60-5	173	SL50SSP3-1	175	SP-15900	204	SP-96009	165	ST35-20-5	173
SL34-80-5	173	SL50SSP3-7	174	SP-18914	199	ST10-40-5	173	ST35-30-5	173
SL34-90-5	173	SL50SSP3R-1	175	SP-2114	201	ST10-XX-1	172	ST35-40-5	173
SL34-XX-1	172	SL50SSP3SB-1	175	SP-2114-T	201	ST11-XX-1	172	ST35-50-5	173
SL35-20-5	173	SL513HBP3R-1	176	SP-2134	201	ST13-60-5	173	ST35-XX-1	172
SL35-30-5	173	SL513HP3R-1	176	SP-2134-T	201	ST13-XX-1	172	ST36-20-5	173
SL35-40-5	173	SL514HSSP3-1	176	SP-2164	201	ST14-20-5	173	ST36-30-5	173
SL35-50-5	173	SL52P3-1	176	SP-2164-T	201	ST14-30-5	173	ST36-40-5	173
SL35-XX-1	172	SL52P3R-1	176	SP-2244	201	ST14-40-5	173	ST36-50-5	173
SL3-60-5	173	SL52SSP3-1	176	SP-2244-ADJ	201	ST14-50-5	173	ST36-60-5	173
SL36-20-5	173	SL52SSP3R-1	176	SP-2244-ADJ-T	201	ST14-60-5	173	ST36-70-5	173
SL36-30-5	173	SL54SSP3-1	176	SP-28911	199	ST14-XX-1	172	ST36-80-5	173
SL36-40-5	173	SL57P3-1	176	SP-28913	199	ST15-XX-1	172	ST36-90-5	173
SL36-50-5	173	SL57SSP3R-1	176	SP-3004	201	ST20-XX-1	172	ST36-XX-1	172
SL36-60-5	173	SL58BP3-1	176	SP-3004-R	201	ST26-XX-1	172	ST37-XX-1	172
SL36-70-5	173	SL58BP3R-1	176	SP-3004-R-T	201	ST29-XX-1	172	STX20-XX-1	172
SL36-80-5	173	SL58P3-1	176	SP-3004-T	201	ST30-20-5	173	STX29-XX-1	172
SL36-90-5	173	SL58P3R-1	176	SP-3204	201	ST30-40-5	173		
SL36-XX-1	172	SL58SSBP3R-1	176	SP-3204-R	201	ST30-60-5	173		
SL37-XX-1	172	SL58SSP3-1	176	SP-3204-R-T	201	ST30-XX-1	172		
SL38-XX-1	172	SL58SSP3R-1	176	SP-3204-T	201	ST31-20-5	173		
SL3HSSP3-1	175	SL61SSBS-1	177	SP-37904	199	ST31-30-5	173		
SL3-XX-1	172	SL62SSBS-1	177	SP-37914	199	ST31-40-5	173		
SL40BP3-1	175	SL63SSBS-1	177	SP-4000-ADJ-RB	152	ST31-XX-1	172		
SL40P3-1	175	SL64-BS-1	174	SP-400-RB	152	ST32-20-5	173		
SL40SSBP3-1	175	SL64SSBS-1	174	SP-402	152	ST32-30-5	173		
SL40SSP3-1	175	SL65BP3-1	177	SP-410	152	ST32-XX-1	172		
SL40SSP3-7	174	SL65P3-1	177	SP-416	152	ST33-20-5	173		
SL44BP3R-1	175	SL65SSP3-1	177	SP-421-RB	152	ST33-30-5	173		
SL44P3-1	175	SL69-BS-1	174	SP-424-ADJ-RB	152	ST33-40-5	173		
SL44P3R-1	175	SL69SSBS-1	174	SP-429-RB	152	ST33-50-5	173		

Ingress Protection (IP) Ratings Guide











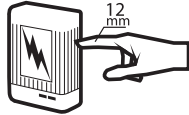

Example:

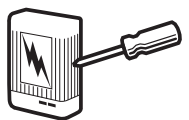
An IP65 rating can be determined using the adjacent table and example:

- The first number of the rating example, 6, in the gray column means the enclosure is dust tight
- The second number of the rating example, 5, in the blue column means the enclosure is protected against jets of water

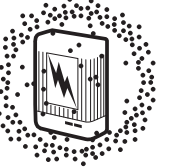
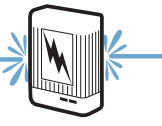
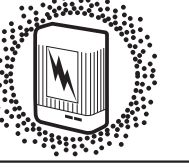
The IP rating system was established by the International Electrotechnical Commission (IEC), an organization for international standards and conformity assessment. The IEC collaborates closely with the International Organization for Standardization (ISO). A complete description of the IP ratings and associated tests is found in IEC Publication 529. Although these ratings were initially developed as a way to classify enclosures, they now provide a convenient, practical way to compare levels of sealing. Many electrical products have an Ingress Protection (IP) rating which identifies the environmental factors needing consideration prior to the product's installation.

This is important when deciding when to mount products in a dry and clean environment versus a wet and/or dusty environment. The IP rating indicates the degree of protection provided. The numbers following IP represent levels of sealing and can range from no protection to full protection against dust and water. The table provides a description of the protection at each level.

SOLIDS		WATER	
1	 Protected against a solid object greater than 50 mm such as a hand.	1	 Protected against vertically falling drops of water. Limited ingress permitted.
2	 Protected against a solid object greater than 12 mm such as a finger.	2	 Protected against vertically falling drops of water with enclosure tilted up to 15 degrees from the vertical. Limited ingress permitted.
3	 Protected against a solid object greater than 2.5 mm such as a screwdriver.	3	 Protected against sprays of water up to 60 degrees from the vertical. Limited ingress permitted for three minutes.
4	 Protected against a solid object greater than 1 mm such as a wire.	4	 Protected against water splashed from all directions. Limited ingress permitted.
5	 Dust Protected. Limited ingress of dust permitted. Will not interfere with operation of the equipment. Two to eight hours.	5	 Protected against jets of water. Limited ingress permitted.
6	 Dust tight. No ingress of dust. Two to eight hours.	6	 Water from heavy seas or water projected in powerful jets shall not enter the enclosure in harmful quantities.
		7	 Protection against the effects of immersion in water between 15 cm and 1 m for 30 minutes.
		8	 Protection against the effects of immersion in water under pressure for long periods.

Rating Example:

IP65

INGRESS PROTECTION



Learn more about anchors and docking we have.