



**ATD-80416**  
**16-WATT LED WORK LIGHT**  
**&**  
**ATD-80417**  
**16-WATT LED SWING ARM DOCK LIGHT**  
**OWNERS MANUAL**



**ATD-80416**



**ATD-80417**

**Features:**

- Heavy-duty diecast yellow powder coated aluminum housing for high visibility and excellent corrosion resistance
- 16 ft. oil-resistant power cord remains flexible in cold weather
- Light head has special lens to illuminate loading docks and inside trailers
- 180° swivel bracket on light head allows unlimited mounting options (ATD-80416)
- 40" swing arm with 1.5" square tubing for extra strength and durability (ATD-80417)
- Swivel bracket on dock light arm allows easy wall mounting (ATD-80417)
- CSA outdoor certificate

**Specifications:**

- Power Cord: 18/3 SJTOW – 16 ft. length
- Brightness: 1400 lumens
- IP67 rating

 **California Prop 65 WARNING:**

This product contains chemicals including lead, known to the State of California to cause cancer, birth defects, or other reproductive harm. **Wash hands after handling.**

## General Safety Warnings:

 **WARNING:** The instructions and warnings contained in this manual should be read and understood before using or operating this light. Do not allow anyone to use or operate this light until they have read this manual and have developed a thorough understanding of how this light works. Failure to observe any of the following instructions could result in severe personal injury to tool user and bystanders, or cause damage to the tool and property. Keep this manual for future reference.

 **Note:** The warnings and cautions discussed in this instruction manual cannot cover all possible conditions and situations that may occur. It must be understood by the operator that common sense and caution are factors which cannot be built into this product, but must be supplied by the operator.

 **WARNING:** Always keep your work area clean, uncluttered, and well lit. Cluttered or dark areas invite accidents and injuries. DO NOT work on floor surfaces that are slippery.

---

## Electrical Safety Warnings:

 **WARNING:** Read all safety warnings and instructions. Failure to follow all warnings and instructions may result in electric shock, fire and/or serious injury or death.

 **WARNING:** Before connecting a light to a power supply, always check to ensure the power supply corresponds to the voltage on the nameplate of the light. A power supply with a voltage greater than that specified for the light can result in serious injury to the user, as well as damage to the light. Using a power supply with a voltage less than the nameplate rating is harmful to the motor. If in doubt, do not plug in the light.

 **WARNING:** Grounded lights must be plugged into an outlet properly installed and grounded in accordance with all codes and ordinances. This light is equipped with a 3-prong plug and a 3-wire grounding system. Never remove the grounding prong or modify the plug in any way. Do not use any adapter plugs. Check with a qualified electrician if you are in doubt as to whether the outlet is properly grounded.

 **NOTE:** Double insulated lights are equipped with a polarized plug (one blade is wider than the other). This plug will fit in a polarized outlet only one way. If the plug does not fit fully in the outlet, reverse the plug. If it still doesn't fit, contact a qualified electrician to install a polarized outlet. Do not change the plug in any way.

 **WARNING:** To reduce the risk of electric shock, DO NOT use in damp conditions, on wet surfaces, or expose to rain. Do not plug in this light or operate it with wet hands or while standing in water.

 **WARNING:** Never use the cord for carrying, pulling or unplugging the power light. Grasp plug and pull to disconnect from outlet. Keep cord away from heat, oil, sharp edges or moving parts. Replace damaged cords immediately.

 **WARNING:** Always remove the power cord from the electric outlet when making adjustments, changing parts, cleaning or working on the light.

 **WARNING:** Care should be taken to arrange the cord so it will not be stepped on, tripped over, or otherwise subjected to damage or stress.

 **WARNING:** Never attempt to plug in or operate equipment with defective or damaged wires, power cord or power cord plug. Have any defective or damaged parts replaced immediately by qualified personnel.

 **WARNING:** Avoid body contact with electrically grounded surfaces. There is an increased risk of electric shock if your body is grounded.

 **WARNING:** If the work area is not equipped with a permanently installed Ground Fault Circuit Interrupter outlet (GFCI), use a plug-in GFCI between the power light or extension cord and the power receptacle.

 **WARNING:** If an extension cord is necessary, use only 'Listed' extension cords. If used outdoors, they must be marked "For Outdoor Use". Those cords having a 3-prong grounding type plugs and mating receptacles are to be used with grounded lights.

 **WARNING:** Use of improper size or gauge of extension cord may cause unsafe or inefficient operation of your light, or cause damage to your light. Be sure your extension cord is rated to allow sufficient current flow to the motor. If in doubt, always use a larger gauge cord. Be sure to check the voltage requirements of the light to your incoming power source.

 **NOTE:** The table below shows the correct size to use according to cord length and the amperage draw of the light (specified on the nameplate). When in doubt, use the next heavier gauge. The smaller the gauge number, the heavier the cord. (AWG = American Wire Gauge).

Minimum Gauge for Extension Cords (AWG)  
(when using 120 volts only)

Ampere Rating		Total Length of Cord in Feet (meters)			
More Than	Not More Than	25' (7.6m)	50' (15m)	100' (30.4m)	150' (45.7m)
0	6	18	16	16	14
6	10	18	16	14	12
10	12	16	16	14	12
12	16	14	12	<b>Not Recommended</b>	

 **WARNING:** The work light must be connected to a 120 VAC power source as specified. All wiring should be performed by a qualified electrician.

 **WARNING:** Disconnect power (unplug the light) before installing or servicing.

 **WARNING:** To reduce the risk of electric shock, lights should be plugged directly into a properly installed and grounded 3-prong receptacle. Use only a 3-wire extension cord that has a 3-prong grounding type plug with 3-pole receptacles that accept the equipment plug.

 **WARNING:** These fixtures are not intended to be used in potentially dangerous locations, such as flammable or explosive atmospheres.

 **WARNING:** Do not disassemble the light head. The water resistant function will be affected after disassembling/opening the light.

 **WARNING:** Keep plugs and receptacles dry.

### **ATD-80416 & ATD-80417 Operation:**

- 1) The light is turned on and off with a switch located on the back of the lamp head.



# ATD-80416

# ATD-80417

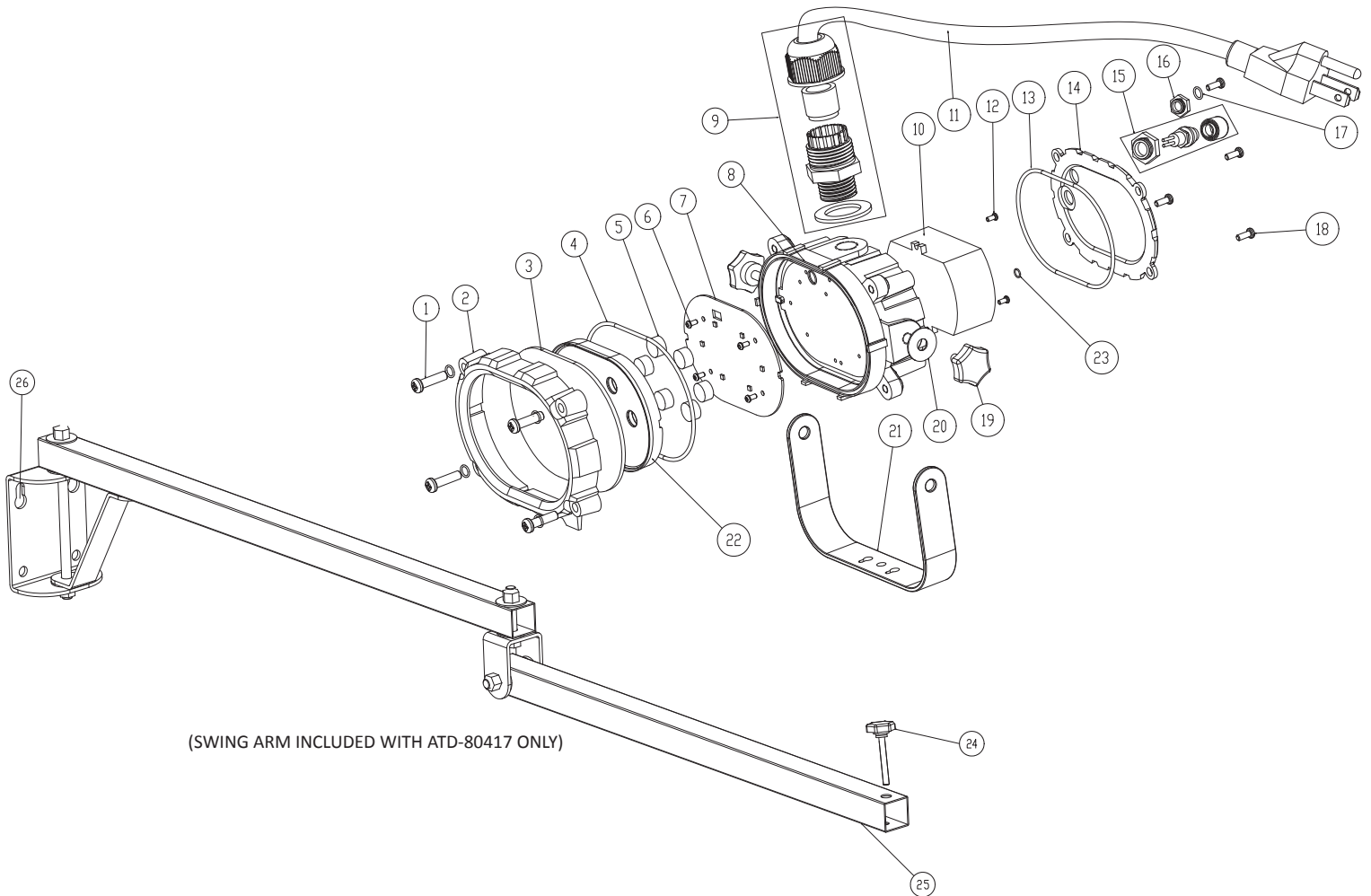

(SWING ARM INCLUDED WITH ATD-80417 ONLY)

ITEM#	ORDERING PART#	PART DESCRIPTION
1	PRT80416-01	SCREW A
2	PRT80416-02	UPPER HOUSING
3	PRT80416-03	TEMPERED GLASS
4	PRT80416-04	O-RING 1
5	PRT80416-05	LENS
6	PRT80416-06	SCREW B
7	PRT80416-07	PCBA
8	PRT80416-08	LAMP HOLDER COVER
9	PRT80416-09	WATER RESISTANT ADAPTER CONNECTOR
10	PRT80416-10	DRIVER
11	PRT80416-11	CORD, 18/3 SJTOW 16'
12	PRT80416-12	SCREW C
13	PRT80416-13	O-RING 2

ITEM#	ORDERING PART#	PART DESCRIPTION
14	PRT80416-14	BACK HOUSING
15	PRT80416-15	SWITCH
16	PRT80416-16	RESPIRATOR
17	PRT80416-17	PAD A
18	PRT80416-18	SCREW D
19	PRT80416-19	HAND BOLT A
20	PRT80416-20	INTERNAL TOOTHED WASHER
21	PRT80416-21	BRACKET
22	PRT80416-22	REFLECTOR
23	PRT80416-23	PAD B
24	PRT80417-24	HAND BOLT B
25	PRT80417-25	ARM STAND
26	PRT80417-26	EXPANSION SCREW

When it comes to quality portable work lights, ATD is the brand you can depend on.