



ATD-80335

35W COB LED Work Light w/Telescopic Stand

Instruction Manual



Features:

- Super bright 35 Watt COB LED
- Heavy-duty industrial design with diecast aluminum housing
- 16 ft. water-resistant power cord remains flexible in cold weather
- Quick fastening light head for easier adjustment
- 160 degree horizontal rotation on base
- Rotating telescopic stand easily folds for storage and extends from 25" to 72"
- IP67 rated for dust and water resistance
- CSA outdoor certificate
- Long beam distance

Specifications:

- Power Cord: 18/3 SJTW
- Lumens: 4200
- Lux: 1300

General Safety Warnings:

 **WARNING:** The instructions and warnings contained in this manual should be read and understood before using or operating this light. Do not allow anyone to use or operate this light until they have read this manual and have developed a thorough understanding of how this light works. Failure to observe any of the following instructions could result in severe personal injury to light user and bystanders, or cause damage to the light and property. Keep this manual for future reference.

 **Note:** The warnings and cautions discussed in this instruction manual cannot cover all possible conditions and situations that may occur. It must be understood by the operator that common sense and caution are factors which cannot be built into this product, but must be supplied by the operator.

 **WARNING:** Use safety equipment. Users and bystanders should use safety goggles or safety glasses with side shields which comply with current national standards, or when needed, a face shield. Use an ANSI approved dust mask or respirator when working around metal, wood, and chemical dusts and mists. This applies to all persons in the work area. Also use non-skid safety shoes, hardhat, gloves, dust collection systems, and hearing protection when appropriate.

 **WARNING:** Keep bystanders and children out of the work area while operating this light.

 **WARNING:** Always keep your work area clean, uncluttered, and well lit. Cluttered or dark areas invite accidents and injuries. DO NOT work on floor surfaces that are slippery.

 **WARNING:** Do not operate this light if you are tired or under the influence of alcohol, drugs, or medications that could affect your ability to use the light properly.

 **WARNING:** Dress properly. Do not wear loose clothing or jewelry as they can be caught in moving parts. Wear restrictive hair covering to contain long hair.

 **WARNING:** Do not reach over or across running machines. Keep proper footing and balance at all times. Non-skid footwear is recommended when working.

Electrical Safety Warnings:

 **WARNING:** Read all safety warnings and instructions. Failure to follow all warnings and instructions may result in electric shock, fire and/or serious injury or death.

 **WARNING:** Before connecting a light to a power supply, always check to ensure the power supply corresponds to the voltage on the nameplate of the light. A power supply with a voltage greater than that specified for the light can result in serious injury to the user, as well as damage to the light. Using a power supply with a voltage less than the nameplate rating is harmful to the motor. If in doubt, do not plug in the light.

 **WARNING:** Grounded lights must be plugged into an outlet properly installed and grounded in accordance with all codes and ordinances. This light is equipped with a 3-prong plug and a 3-wire grounding system. Never remove the grounding prong or modify the plug in any way. Do not use any adapter plugs. Check with a qualified electrician if you are in doubt as to whether the outlet is properly grounded.

 **NOTE:** Double insulated lights are equipped with a polarized plug (one blade is wider than the other). This plug will fit in a polarized outlet only one way. If the plug does not fit fully in the outlet, reverse the plug. If it still doesn't fit, contact a qualified electrician to install a polarized outlet. Do not change the plug in any way.

 **WARNING:** To reduce the risk of electric shock, DO NOT use in damp conditions, on wet surfaces, or expose to rain. Do not plug in this light or operate it with wet hands or while standing in water.

 **WARNING:** Never use the cord for carrying, pulling or unplugging the light. Grasp plug and pull to disconnect from outlet. Keep cord away from heat, oil, sharp edges or moving parts. Replace damaged cords immediately.

 **WARNING:** Always remove the power cord from the electric outlet when making adjustments, changing parts, cleaning or working on the light.

 **WARNING:** Care should be taken to arrange the cord so it will not be stepped on, tripped over, or otherwise subjected to damage or stress.

 **WARNING:** Never attempt to plug in or operate equipment with defective or damaged wires, power cord or power cord plug. Have any defective or damaged parts replaced immediately by qualified personnel.

 **WARNING:** Avoid body contact with electrically grounded surfaces. There is an increased risk of electric shock if your body is grounded.

 **WARNING:** If the work area is not equipped with a permanently installed Ground Fault Circuit Interrupter outlet (GFCI), use a plug-in GFCI between the light or extension cord and the power receptacle.

 **WARNING:** If an extension cord is necessary, use only 'Listed' extension cords. If used outdoors, they must be marked "For Outdoor Use". Those cords having a 3-prong grounding type plug and mating receptacles are to be used with grounded lights.

 **WARNING:** Use of improper size or gauge of extension cord may cause unsafe or inefficient operation of your light or tool, or cause damage to your light or tool. Be sure your extension cord is rated to allow sufficient current flow to

the motor of your tool. If in doubt, always use a larger gauge cord. Be sure to check the voltage requirements of the light to your incoming power source.



NOTE: The table below shows the correct size to use according to cord length and the amperage draw of the light (specified on the nameplate). When in doubt, use the next heavier gauge. The smaller the gauge number, the heavier the cord. (AWG = American Wire Gauge).

Minimum Gauge for Extension Cords (AWG)
(when using 120 volts only)

Ampere Rating		Total Length of Cord in Feet (meters)			
More Than	Not More Than	25' (7.6m)	50' (15m)	100' (30.4m)	150' (45.7m)
0	6	18	16	16	14
6	10	18	16	14	12
10	12	16	16	14	12
12	16	14	12	Not Recommended	

ATD-80335 Specific Safety Instructions:

 **WARNING:** The work light must be connected to 120V power source as specified. All wiring should be performed by a qualified electrician.

 **WARNING:** Disconnect power before installing or servicing.

 **WARNING:** To reduce the risk of electric shock, lights should be plugged directly to a properly installed and grounded 3-prong receptacle. Use only a 3-wire extension cord that has a 3-prong grounding type plug with 3-pole receptacles that accept the equipment plug.

 **WARNING:** These fixtures are not intended to be used in potentially dangerous locations, such as flammable or explosive atmospheres.

 **WARNING:** Do not disassemble the light head. The water resistant function will be affected after disassembling/opening the light.

 **WARNING:** Keep plugs and receptacles dry.

 **WARNING:** Do not raise the light above the marked warning line on tripod extension to prevent tipping of the light.

ATD-80335 Assembly Instructions:

Illustration A:

Ref#	Description	Qty
01	Light head	1
02	Bolt 1/4"	1
03	Flat washer	1
04	Spring washer	1
05	Bracket	1
06	Light head bracket	1

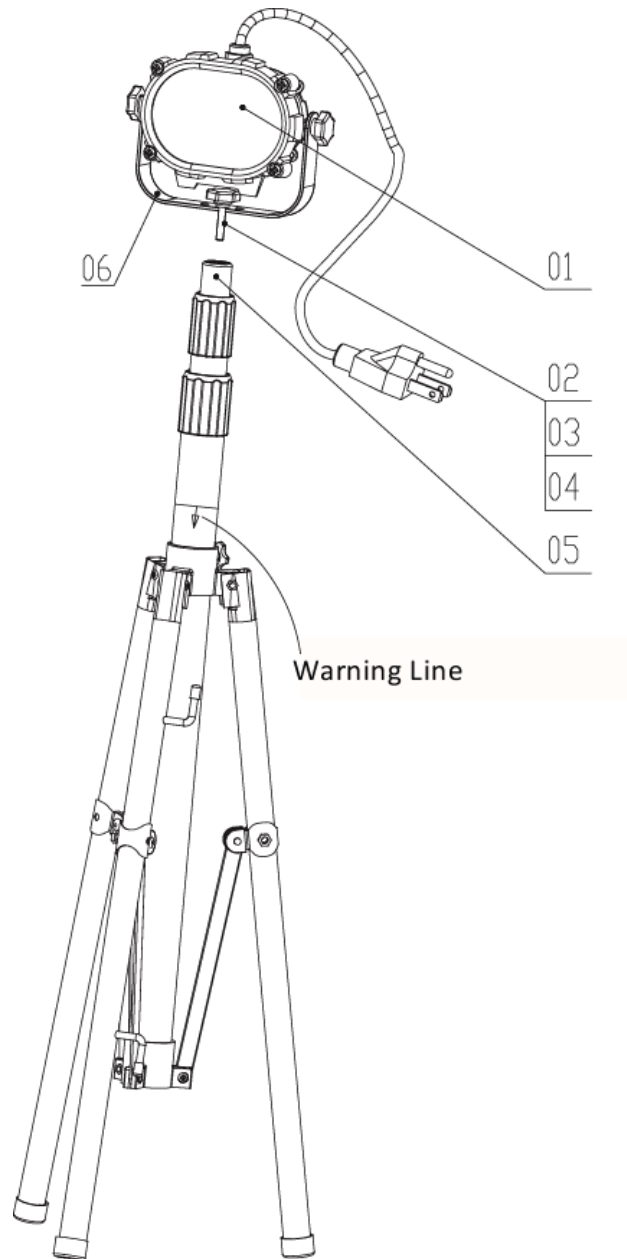

- 1) Insert bolt (02) through the light head bracket (06) slide spring washer (04) and flat washer (03) to the bolt (02) and then thread bolt (02) to the tripod stand as shown illustration above.
- 2) Fasten the bolt (02) to the tripod stand (05) and tighten.
- 3) Velcro can be used to tie cord off.

OPERATION:

- 1) Lamp is turned on and off with a switch located on the back of the lamp head

SABER®

ATD-80335

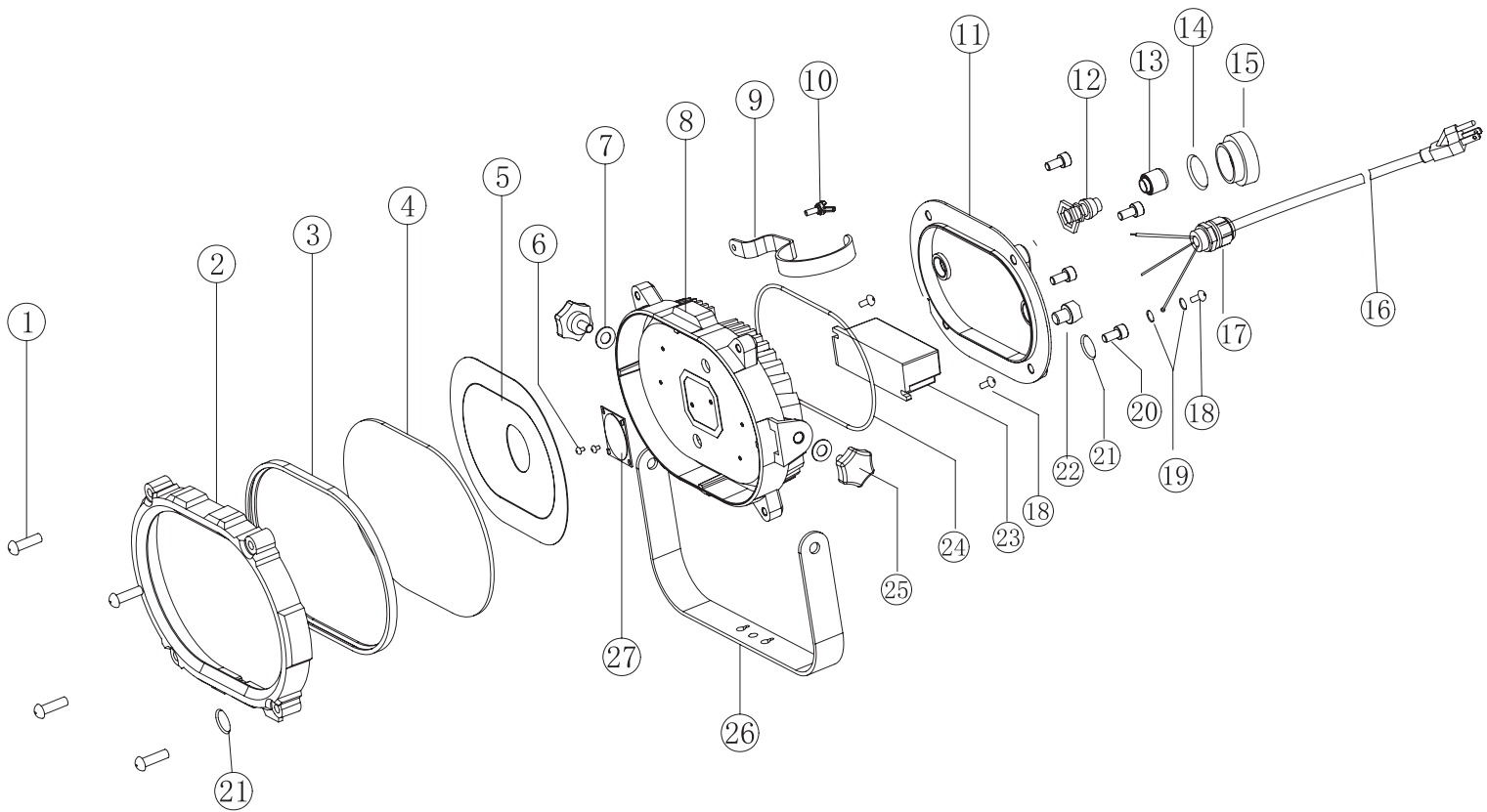

ITEM#	ORDERING PART#	PART DESCRIPTION
1	PRT80335-01	SCREW
2	PRT80335-02	HOUSING, UPPER
3	PRT80335-03	SEALING RING
4	PRT80335-04	TEMPERED GLASS
5	PRT80335-05	REFLECTOR
6	PRT80335-06	SCREW
7	PRT80335-07	INNER JAGGED WASHER
8	PRT80335-08	HOUSING,MIDDLE
9	PRT80335-09	HOOK
10	PRT80335-10	BUTTERFLY SCREW
11	PRT80335-11	BUTTERFLY SCREW
12	PRT80335-12	BUTTON SWITCH
13	PRT80335-13	SWITCH SEALING COVER
14	PRT80335-14	O RING

ITEM#	ORDERING PART#	PART DESCRIPTION
15	PRT80335-15	SWITCH BASE
16	PRT80335-16	CORD,18/3 SJTOW
17	PRT80335-17	WATER RESISTANT ADAPTER CONNECTOR
18	PRT80335-18	SCREW
19	PRT80335-19	OUTSIDE WASHER 2
20	PRT80335-20	SCREW
21	PRT80335-21	OUTSIDE WASHER 1
22	PRT80335-22	RESPIRATOR
23	PRT80335-23	DRIVER
24	PRT80335-24	O RING 1
25	PRT80335-25	HAND BOLT
26	PRT80335-26	BRACKET
27	PRT80335-27	COB LED

SABER[®]

ATD-80335

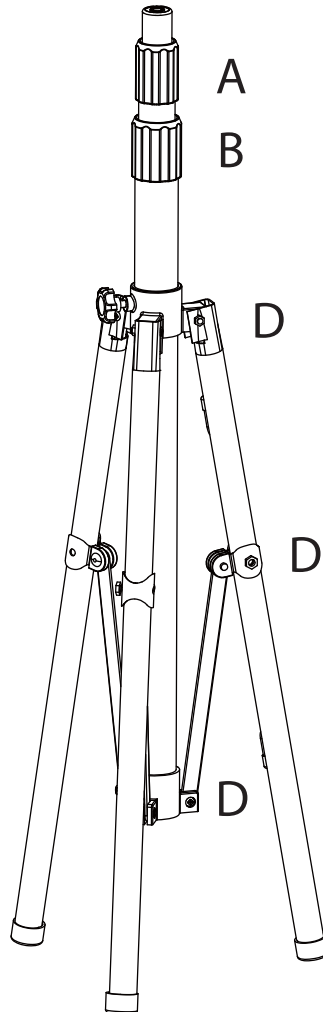

STAND PARTS		
ITEM#	ORDERING PART#	PART DESCRIPTION
A	PRT80422-30-1	UPPER TELESCOPING NUT ASSY (SMALL)
B	PRT80422-30-2	LOWER TELESCOPING NUT ASSY (LARGE)
C	PRT80422-30-3	CASTER FOR ROLL AROUND STAND
D	PRT80420-30-1	HINGE BASE, 3 HINGES, UPPER HINGE SLIDE