



ATD-30342A 42" Belt Drive Drum Fan Owner's Manual



Features:

- Powerful two-speed direct drive motor provides even airflow
- Convenient handles and durable rubber wheels provide added portability
- Balanced aluminum 4-blade design provides even airflow and quiet operation
- Automatic shut-off feature prevents overheating
- Durable black powder coating finish
- 8 ft. grounded cord

Specifications:

- 5/8 Hp Motor
- Up to 12,050 CFM
- cETL listed
- Size: 44" L x 14" W x 45" H

General Safety Warnings:

 **WARNING:** The instructions and warnings contained in this manual should be read and understood before using or operating this fan. Do not allow anyone to use or operate this fan until they have read this manual and have developed a thorough understanding of how this fan works. Failure to observe any of the following instructions could result in severe personal injury to fan user and bystanders, or cause damage to the fan and property. Keep this manual for future reference.

 **Note:** The warnings and cautions discussed in this instruction manual cannot cover all possible conditions and situations that may occur. It must be understood by the operator that common sense and caution are factors which cannot be built into this product, but must be supplied by the operator.

Electrical Safety Warnings:

 **WARNING:** Read all safety warnings and instructions. Failure to follow all warnings and instructions may result in electric shock, fire and/or serious injury or death.

 **WARNING:** Before connecting a fan to a power supply, always check to ensure the power supply corresponds to the voltage on the nameplate of the fan. A power supply with a voltage greater than that specified for the fan can result in serious injury to the user, as well as damage to the fan. Using a power supply with a voltage less than the nameplate rating is harmful to the motor. If in doubt, do not plug in the fan.

 **WARNING:** Grounded fans must be plugged into an outlet properly installed and grounded in accordance with all codes and ordinances. This fan is equipped with a 3-prong plug and a 3-wire grounding system. Never remove the grounding prong or modify the plug in any way. Do not use any adapter plugs. Check with a qualified electrician if you are in doubt as to whether the outlet is properly grounded.

 **NOTE:** Double insulated fans are equipped with a polarized plug (one blade is wider than the other). This plug will fit in a polarized outlet only one way. If the plug does not fit fully in the outlet, reverse the plug. If it still doesn't fit, contact a qualified electrician to install a polarized outlet. Do not change the plug in any way.

 **WARNING:** To reduce the risk of electric shock, DO NOT use in damp conditions, on wet surfaces, or expose to rain. Do not plug in this fan or operate it with wet hands or while standing in water.

 **WARNING:** Never use the cord for carrying, pulling or unplugging the fan. Grasp plug and pull to disconnect from outlet. Keep cord away from heat, oil, sharp edges or moving parts. Replace damaged cords immediately.

 **WARNING:** Ensure the switch is in the off position before plugging the fan into the power outlet. In the event of a power failure while the fan is being used, turn the switch off to prevent surprise starting when the power is restored.

 **WARNING:** Always remove the power cord from the electric outlet when making adjustments, changing parts, cleaning or working on the fan.

 **WARNING:** Care should be taken to arrange the cord so it will not be stepped on, tripped over, or otherwise subjected to damage or stress. DO NOT run power cords under carpeting, do not cover with throw rugs or the like.

 **WARNING:** Never attempt to plug in or operate equipment with defective or damaged wires, power cord or power cord plug. Have any defective or damaged parts replaced immediately by qualified personnel.

 **WARNING:** Avoid body contact with electrically grounded surfaces. There is an increased risk of electric shock if your body is grounded.

 **WARNING:** If the work area is not equipped with a permanently installed Ground Fault Circuit Interrupter outlet (GFCI), use a plug-in GFCI between the fan and the power receptacle.

 **WARNING:** This fan is for **INDOOR** use **ONLY**.

 **WARNING:** Avoid the use of extension cords with this fan. If an extension cord **MUST** be used, be sure that it is a **MINIMUM** of 14 AWG and rated not less than 1875 Watts.

 **WARNING:** Never operate this fan without the protective front and rear guards in place. Do not stick anything through the guards that will come in contact with the moving blades (fingers, tools, etc.). Personal injury will result.

 **WARNING:** Never use this fan with any mister or spray attachment of any kind.

Wheel Assembly Instructions:

1. Check to ensure all of the assembly parts are included in the plastic bag.
Assembly parts include: 4 screws, 8 gaskets, 2 washers, 2 screw nuts, 1 roller and 2 wheels.(see Figure 1).
2. Insert the axle into the axle frame on the bottom of the fan. Line up the screw holes on the axle frame with the axle (see Figure 2).
3. Insert the long screws through the axle frames and into the axle, and secure with gaskets and nuts. Repeat for both sides of the axle frame (see Figure 3).
4. Slide the wheel onto either end of the axle and secure with gaskets, washers and nuts. (See Figure 4 and 5).



Figure 1



Figure 2



Figure 3



Figure 4



Figure 5

Operating Instructions:

1. Place the fan in the upright position on a safe, flat surface where it cannot fall or be pulled by the cord.
2. Select desired direction of air flow by tilting the fan upward or downward.
3. Plug unit into electrical outlet.
4. Switch the rocker switch from the off position to set desired setting (high and low)
5. Always turn off and unplug the fan after using.

NOTE: DO NOT operate the fan without the guards in place, or if it has malfunctioned or been damaged in any way.

Cleaning:

Before cleaning the fan, be sure to disconnect power cord from the power outlet. Clean the guard surface with a damp cloth. Do NOT use harsh chemicals or abrasive cleaners. DO NOT IMMERSE THE FAN OR ANY WIRES IN WATER. Replace front guard before use. Allow fan to dry completely before use. Periodic guard cleaning with a vacuum will prevent dust build up.

Maintenance:

The motor is sealed from the factory and does not require any interior maintenance, cleaning or lubrication. The internal motor bearings are permanently lubricated and do not require any additional lubrication.

Repair:

Do not operate the fan without the guards in place. Do not use the fan if it has malfunctioned or become damaged in any way. Use only genuine parts when repairing fan. Have only an experienced technician attempt repairs.

ATD®

ATD-30342A

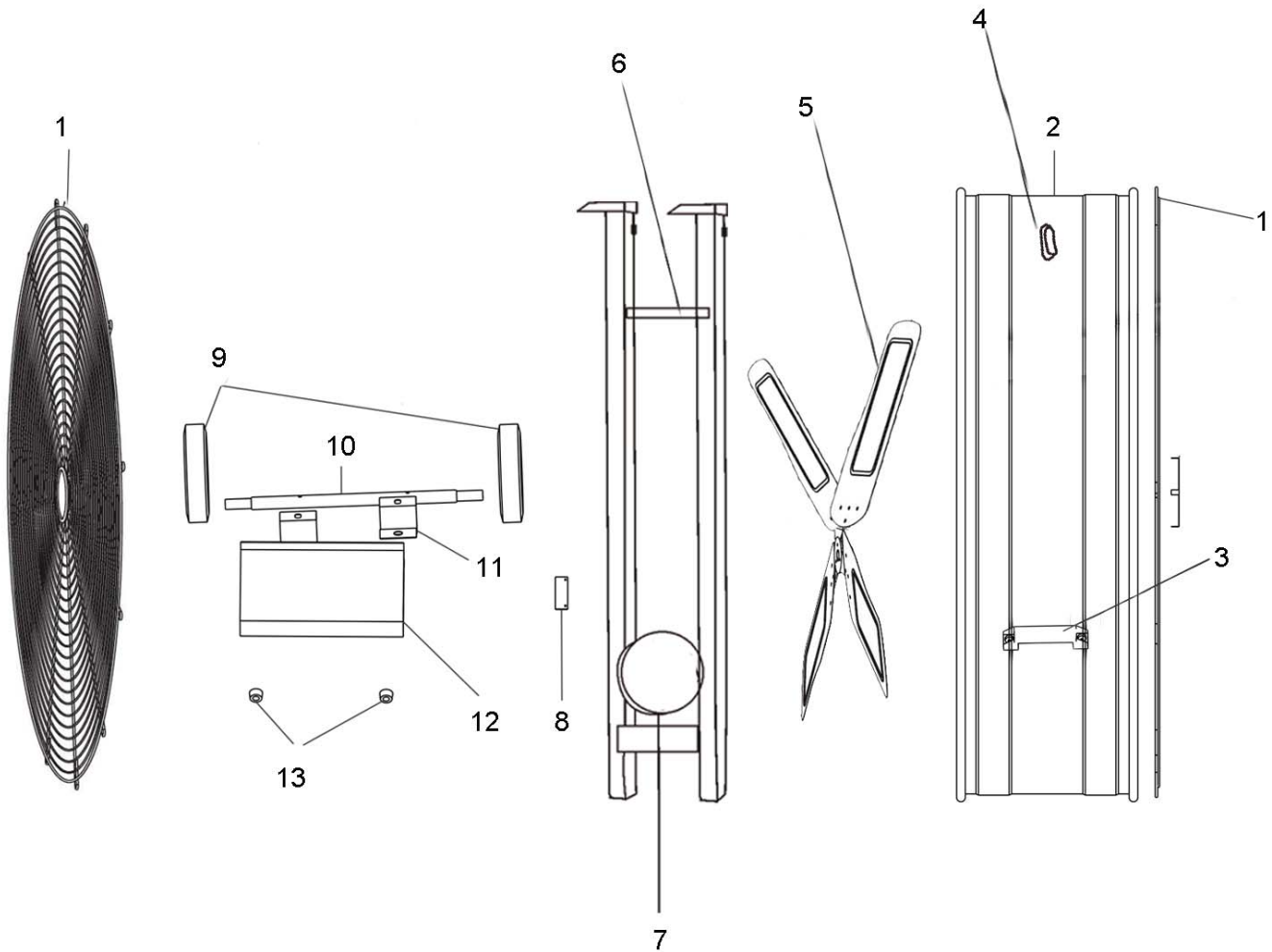

ITEM#	ORDERING PART#	PART DESCRIPTION
1	PRT30342A-01	FRONT AND REAR GUARD
2	PRT30342A-02	DRUM BODY
3	PRT30342A-03	HANDLE
4	PRT30342A-04	ROCKER SWITCH
5	PRT30342A-05	BLADES
6	PRT30342A-06	BRACKET
7	PRT30342A-07	MOTOR

ITEM#	ORDERING PART#	PART DESCRIPTION
8	PRT30342A-08	CAPACITOR
9	PRT30342A-09	WHEELS
10	PRT30342A-10	AXLE
11	PRT30342A-11	AXLE FRAME
12	PRT30342A-12	FRONT SUPPORT
13	PRT30342A-13	SUPPORT PADS