

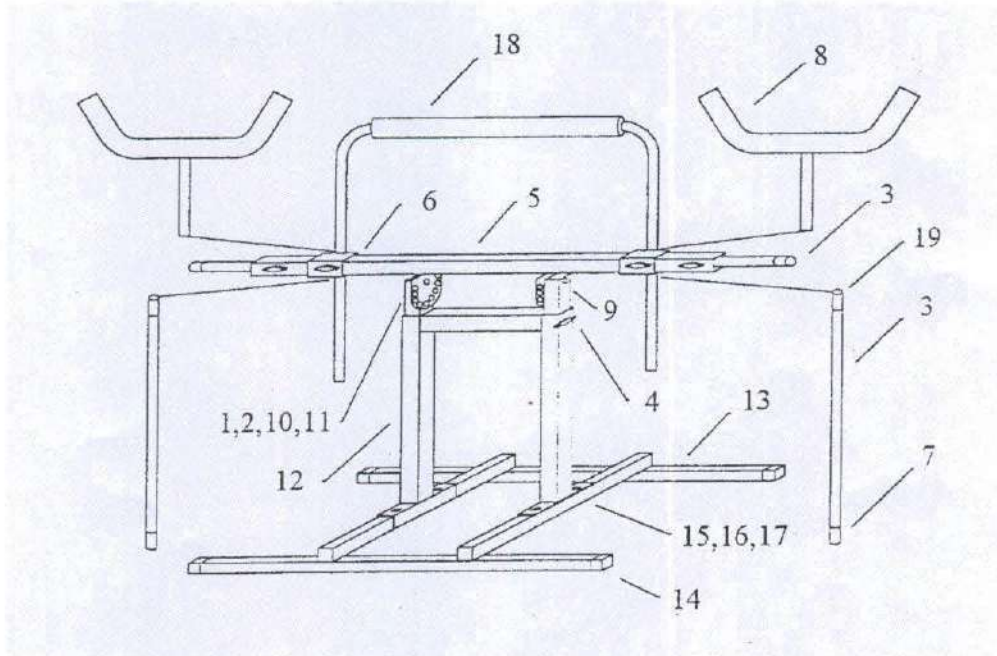

MADE IN THE USA

## DELUXE BUMPER STAND – 77785

The Keysco Tools Deluxe Bumper Stand holds bumpers securely, allowing the user to perform prep and finish work. Vertical and horizontal adjustment with complete 180° swivel capability is performed without the need for any special tools. Three attachments (hoop, pusher tube, inverted) allow bumpers to be positioned at multiple angles.



Key #	Part #	Description	Qty.	Key #	Part #	Description	Qty.
1	11522	Adjustment pin	2	11	10188	1/2 USS washer	4
2	10186	1/2-13 x 3 bolt	2	12	11624	Vertical support	1
3	11490	Pusher tube	4	13	11620	Base	1
4	11497	T-knob	8	14	11381	Tubing cap – square	4
5	11618	Horizontal assy.	1	15	10675	1/4-20 x 2 HHCS	4
6	11489	Slider assy.	2	16	10201	1/4-20 Hex nut	4
7	10688	Tubing cap – round	4	17	10218	1/4 USS washer	4
8	11627	Inverted support	2	18	11626	Hoop	1
9	11623	Vertical tube – square	2	19	10673	Rubber tip	4
10	10187	1/2-13 Nut	2				



# Deluxe Bumper Stand



## Deluxe Bumper Stand with Vertical Arm Attachment

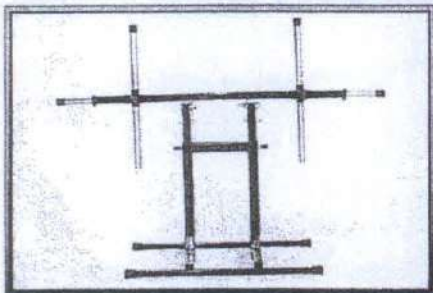

77785

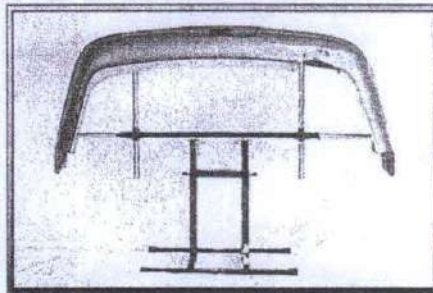

## Deluxe Bumper Stand with Hoop Attachment

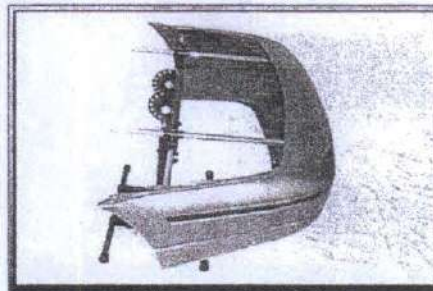
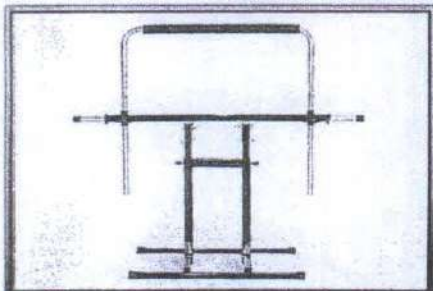

## Deluxe Bumper Stand Features Full 180° Swivel

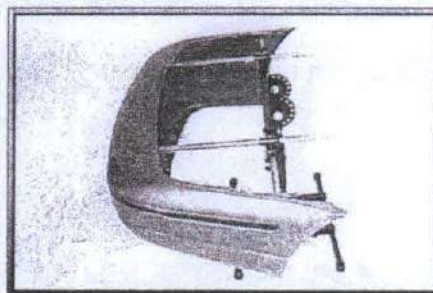
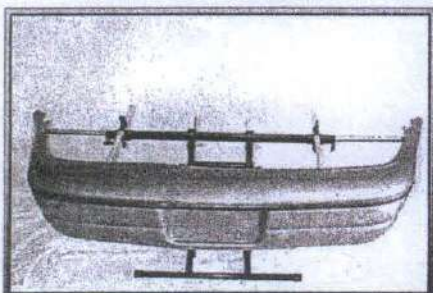

## Inverted Attachment Allows Work On Inside of Bumper

