

Greatly improved performance and environmentally friendly

NVR vs. Conventional type - Component Comparison

Conventional type

Employs single-unit disc spring assembly

NVR performance is greatly increased by positioning the coil springs at the outermost edge of the disc plate.

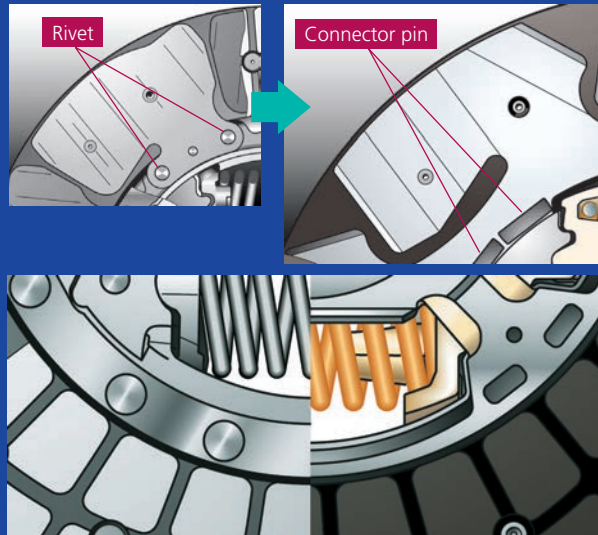

Use of seat stopper

Torque angle is increased by the addition of spring stoppers on the torsion seat.

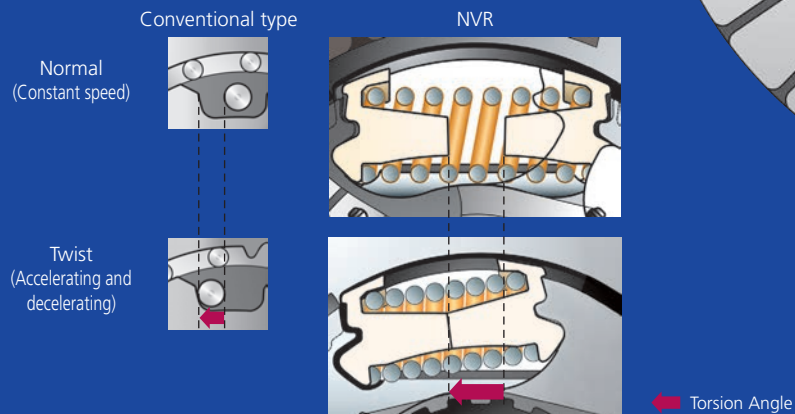

NVR Features

Improved ride comfort

Ability to apply torque with less force improves vibration and sound absorption, enabling a quiet and stable ride.

Improved part coverage

Greater product coverage and part number consolidation is achieved by increasing the torque range.

Improved shift feel

Lower inertia moment by decreasing disc weight, reduces sticking and gear noise.

Improved durability

Addition of seat stoppers to the torsion spring reduces spring wear, increasing durability.

Improved pedal feel

Increased strength and easier half-clutching is achieved through improvements in cover design.



Clutch Disc & Cover

Improvements throughout the NVR clutch disc and cover increases fuel economy, provides a stable ride, and extends product life. Part number consolidations increase coverage with fewer parts.

NVR

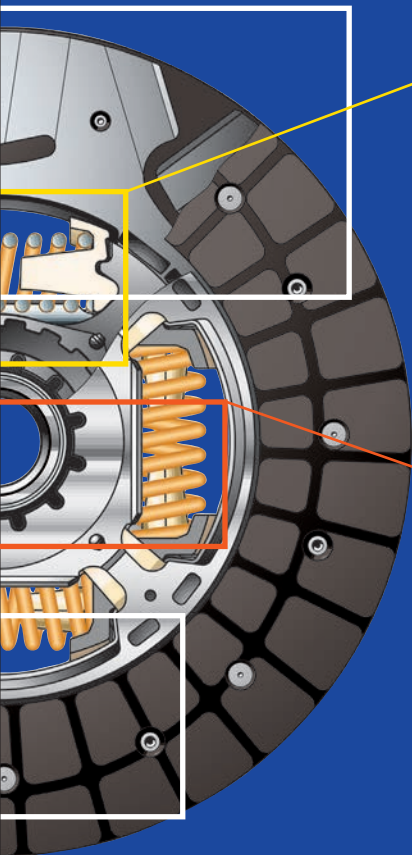

Addition of spring retainer to torsion seat

New coil spring design eliminates contact with the metal plate.

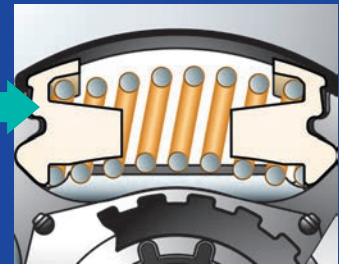
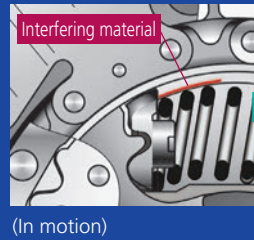

Use of large capacity coil springs

Large capacity coil springs enable expanded torque range.



User Benefits

Comparison against conventional discs

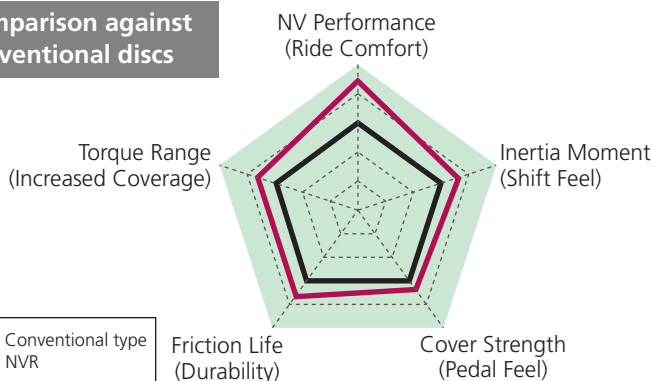



2 AISIN Clutch Characteristics

Clutch Disc Characteristics

- [Extended Product Life] ● Improved product life by adopting facings with excellent heat and wear resistance.
- [Improved Clutch Release Performance] ● Clutch drag prevented by using circumferential grooves in the facings and ensuring sufficient groove depth.
- Improved spline sliding properties by using nickel coated splines.
- [Smoother Engagement] ● Smoother clutch engagement by adopting facings with excellent anti-shudder properties.
- [Reduced Vibration/Noise] ● Reduced drive system vibration and noise through the use of a rigid clutch disc structure and reduced deflection of immobile cushion rubbers.

<Clutch Disc Types>



Torsion Type	Rubber Torsion	Coil torsion	
Hysteresis Structure	Standard Type	Standard Type	Variable Hysteresis Type
Clutch Hub Structure	Integral Hub	Integral Hub	Dual Hub
Characteristics	 <ol style="list-style-type: none"> 1. Drive system for medium to high torque ranges. Reduced vibration/noise. 2. Lightweight and low-inertia. 3. Long torsion component life. 	 <ol style="list-style-type: none"> 1. Drive system for medium to high torque ranges. Reduced vibration/noise. 2. Lightweight and low-inertia. 3. Long product life for torsion component. 	 <ol style="list-style-type: none"> 1. Reduced vibration/noise for all drive systems from low to high torque ranges. 2. Superior performance compared to integral hub.
Applicable Vehicle	FF gasoline vehicle	FR gasoline vehicle	Diesel vehicle

* Some features may not be applicable.

Clutch Cover Characteristics

- [Extended Product Life] ● Reduced lever wear by heat treated diaphragm spring.
- Reduced load fatigue by performing the hot-setting process on the diaphragm spring.
- [Improved Clutch Release Performance] ● Improved clutch-release performance by using a ribbed diaphragm spring.
- Improved clutch-release performance by using a DST (Diaphragm Spring Turnover) type clutch cover.
- [Smoother Engagement] ● Improved shudder resistance by enhanced accuracy in both the bearing adherence strength and pressure plates movement.

<Clutch Cover Types>

Spring Type	Diaphragm Spring		Coil Spring
Clutch Release Method	Push Method	Pull Method	Push Method
Characteristics	 <ol style="list-style-type: none"> 1. Long lasting DST type of clutch cover provides excellent clutch-release performance. 2. Lightweight and compact. 	 <ol style="list-style-type: none"> 1. Superior clutch-release efficiency. 2. Reduced clutch pedal pressure. 	 <ol style="list-style-type: none"> 1. Superior clutch-release efficiency. 2. Easy replacement.
Applicable Vehicle	Applicable in a broad range of vehicle types from sub-compact vehicles to medium size trucks.	Applicable in high-output vehicles (high performance vehicles, etc.).	Applicable in small and medium-sized trucks. Ideal for diesel applications.

* Some features may not be applicable.

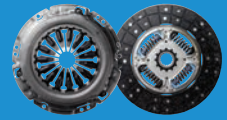

3 Operation Diagram

The most common clutch type is the dry-plate friction clutch. A single friction plate (clutch disc assembly) is placed between the flywheel and pressure plate (located inside the clutch cover assembly). The pressure plate is pressed against or lifted away from the disc to transmit or cut off engine power.

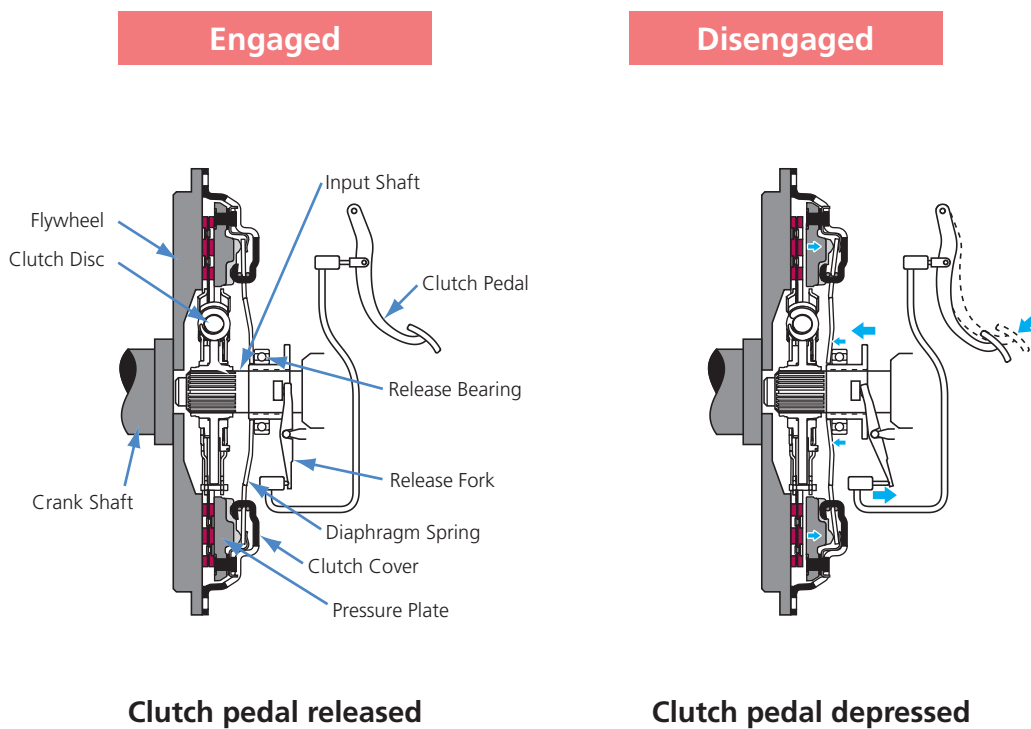

The basic components of a clutch system includes the clutch cover assembly (pressure plate, diaphragm spring, cover, etc.), clutch disc assembly, flywheel, release bearing, and release fork. The clutch disc is located between the flywheel and pressure plates and is connected to the transmission gears by the main drive shaft (input shaft).

4 Structure and Components

Clutch Disc Assembly

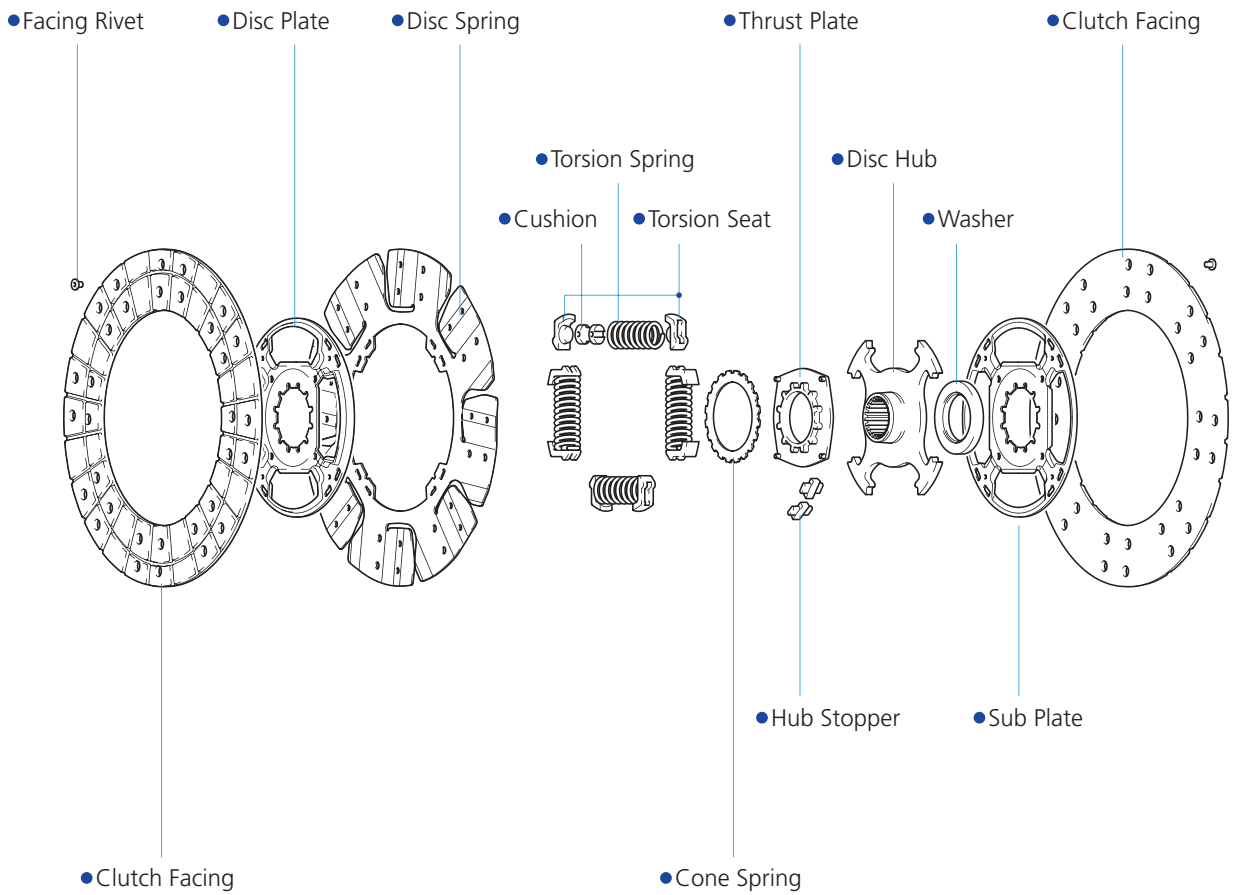

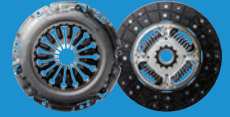

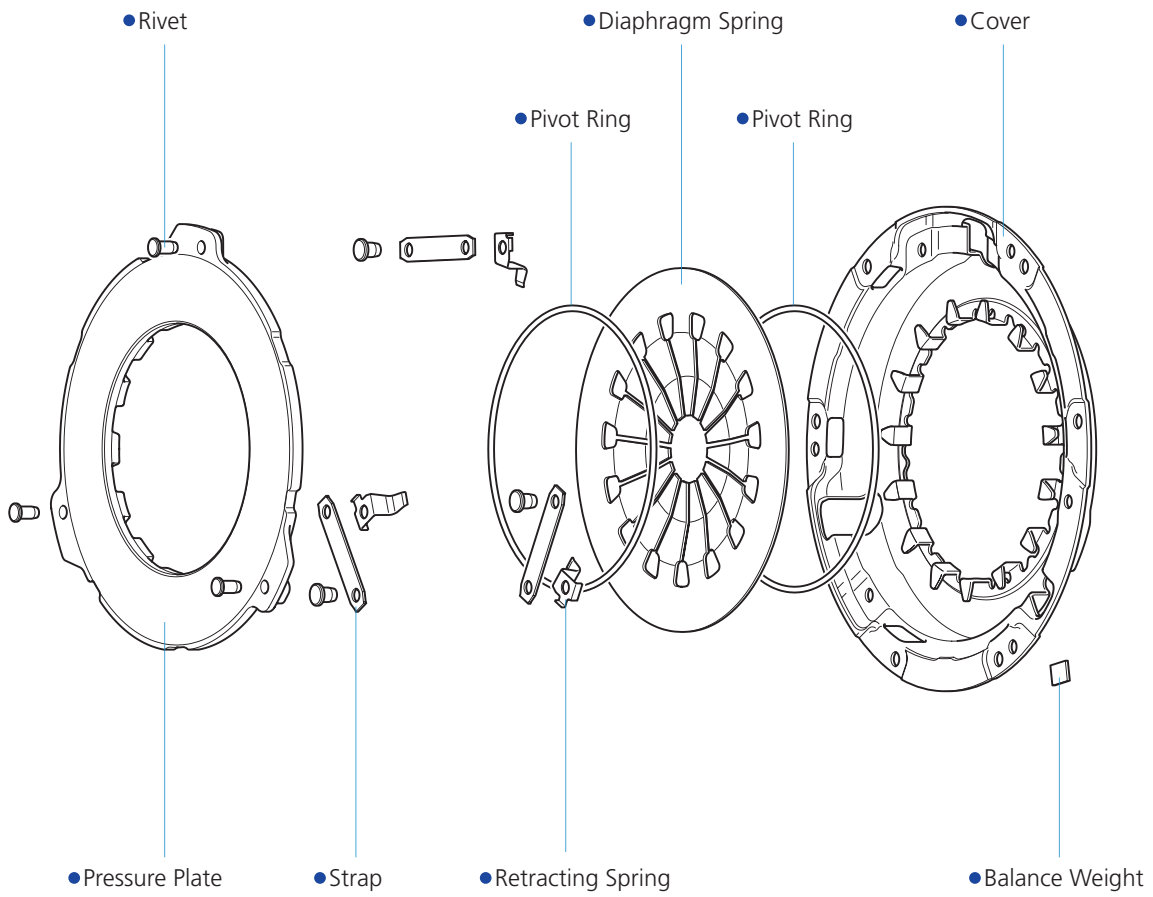

Clutch Cover Assembly

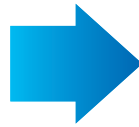

5 Installation Procedure

1 Use caution in the disassembly of the transmission and clutch components from the engine.



2 Clean the Input Shaft.

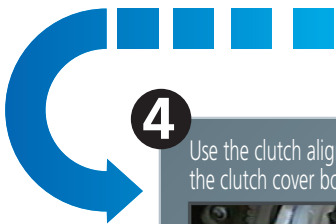
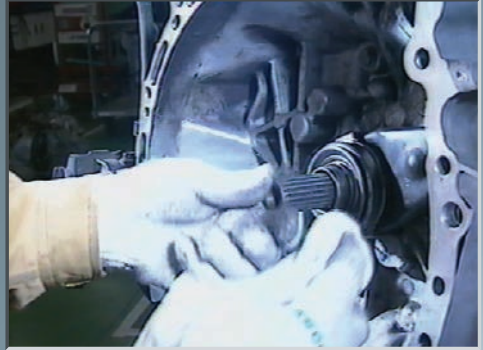

4 Use the clutch alignment tool to locate the clutch disc with the input bearing while tightening the clutch cover bolts. Tighten bolts with torque wrench in a diagonal (star) pattern.

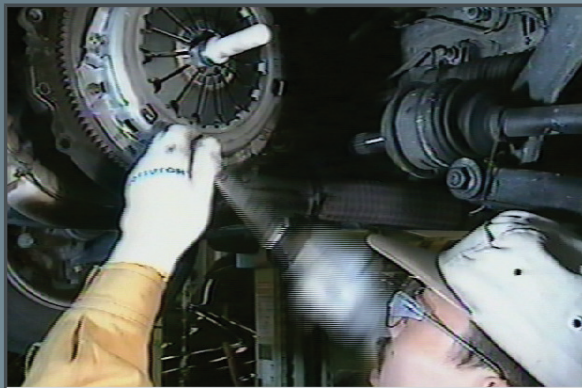

Tightening Sequence

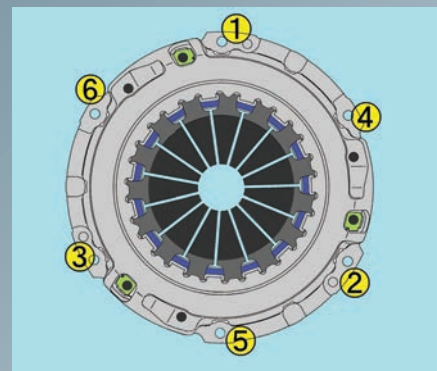

Operation Precautions

Do not drop clutch components.

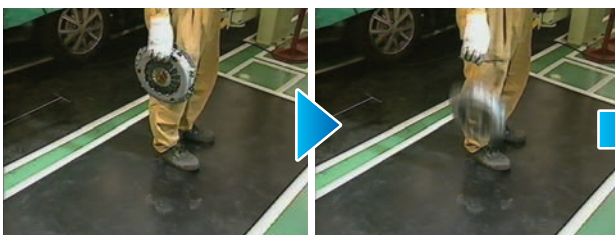

Deformation of the strap or cover will cause failure of the clutch.

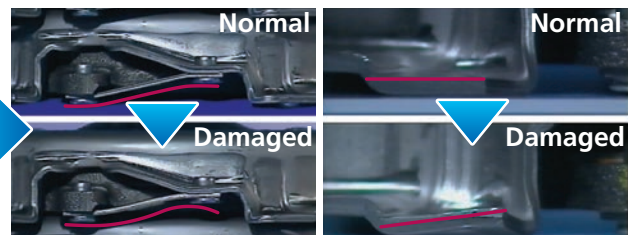

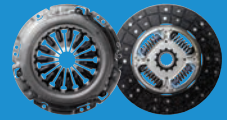
**3**

Apply appropriate amount of grease on the input shaft and disc spline.

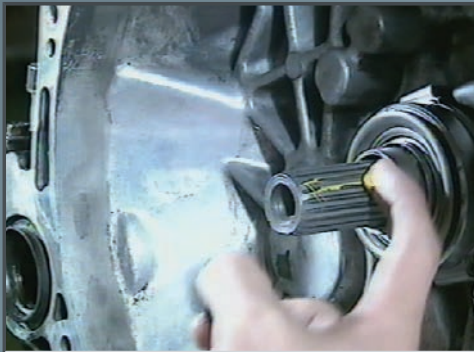
**5**

Confirm evenness of the diaphragm springs (within 0.5mm or 0.02inch).

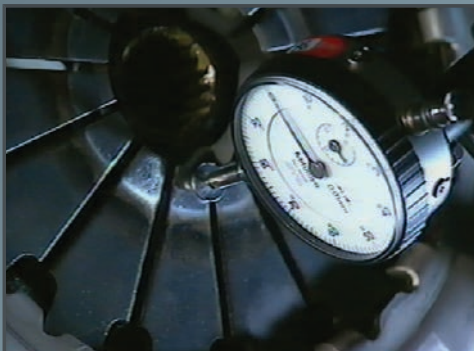

**Align the input shaft
correctly with the clutch disc.**

Incorrect installation will cause problems
such as damage to the clutch disc.

— Key Points for Preventing Failure —

1. Refer to instructions and specifications in the Manufacturer's Service Manual.
2. Do not force or drop parts.

***Always follow instructions
to prevent clutch failure.***

6 Troubleshooting 1

1 Slipping Related Problems

Condition: Oil or similar substance is on the friction surface of the facings.

Disc Related Causes

Cover Related Causes

Other Causes

Cause:

1. Transmission oil or engine oil has leaked onto the facings.
2. Insufficient verification at the time of installation.
3. Problem with vehicle.

Cure:

1. Inspect and repair transmission and/or engine.
2. Replace disc with new part.

Condition: Facings are worn.



Disc Related Causes

Cover Related Causes

Other Causes

Cause:

1. Facings have reached the end of its wear life.
2. Facings have been scorched due to excessive partial clutch engagement, excessive 2nd gear starts, or excessive downshifting, etc.
3. Improper driving method.

Cure:

1. Improve driving method.
2. Replace disc and cover with new parts.

Condition: Facings have broken.



Disc Related Causes

Cover Related Causes

Other Causes

Cause:

1. Facings have burst due to rapid change in torque (i.e.: mis-shifting or speed shifting).
2. Vehicle was driven with scorched facings.
3. Improper driving method.

Cure:

1. Improve driving method.
2. Replace disc and cover with new parts.



Condition: Pressure of the diaphragm spring is weak.



	Disc Related Causes	Cover Related Causes	Other Causes
Cause:		<ol style="list-style-type: none"> 1. Spring function of the diaphragm spring has degraded due to heat fatigue. 2. Wrong part was installed. 3. Improper driving method. 	
Cure:		<ol style="list-style-type: none"> 1. Improve driving method. 2. Replace cover with correct part. 3. Replace disc and cover with new parts. 	

Condition: Misalignment or malfunction in the release mechanism.

	Disc Related Causes	Cover Related Causes	Other Causes
Cause:			<ol style="list-style-type: none"> 1. Release bearing remains connected to the diaphragm spring (partial engagement). (Cable tension changes with use, making the clutch more susceptible to slipping.) 2. Misalignment at time of installation.
Cure:			Readjust the release mechanism.

6 Troubleshooting 2

2 Clutch Drag Related Problems

Condition: Splines are scratched, dented, or damaged.

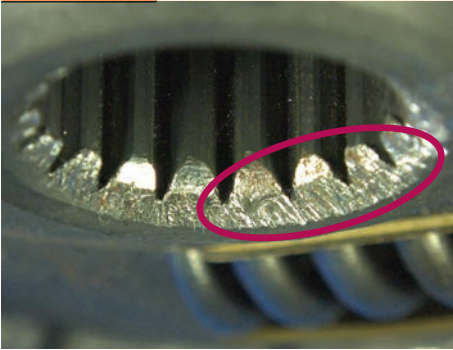

	Disc Related Causes	Cover Related Cause	Other Causes
Cause:	1. Input shaft was scratched or other damage occurred to the splines when installing the transmission, resulting in sliding problems or a deformed disc plate, causing significant run-out. 2. Installation error.		
Cure:	1. Replace disc and cover with new parts. 2. Ensure centering when installing transmission.		

Condition: No grease on splines.

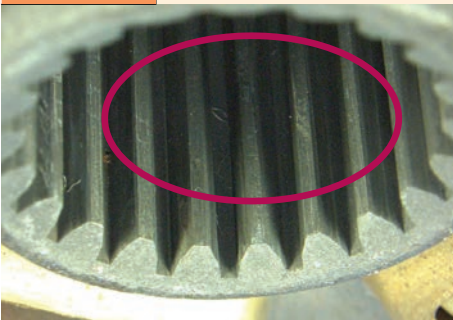

	Disc Related Causes	Cover Related Cause	Other Causes
Cause:	1. Grease was not applied or insufficiently applied when installing the clutch disc, resulting in sliding problems. 2. Installation error.		
Cure:	Apply grease to the disc splines.		

Condition: Deformed clutch disc.

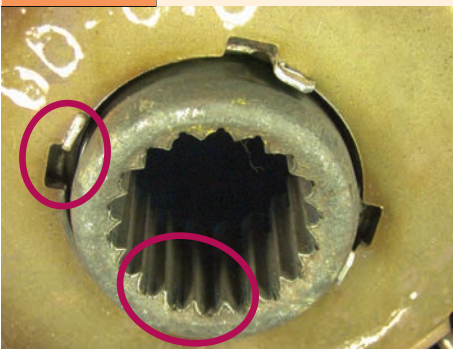

	Disc Related Causes	Cover Related Cause	Other Cause
Cause:	1. Misalignment of the crankshaft and input shaft caused a wobble in the rotation (figure-8 rotation), deforming the disc so that power is transmitted even when disengaged. 2. Installation error.		
Cure:	1. Replace disc and cover with new parts. 2. Ensure centering when installing transmission.		

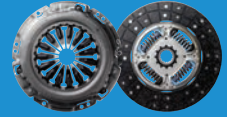

Condition: Straps or other components are deformed.

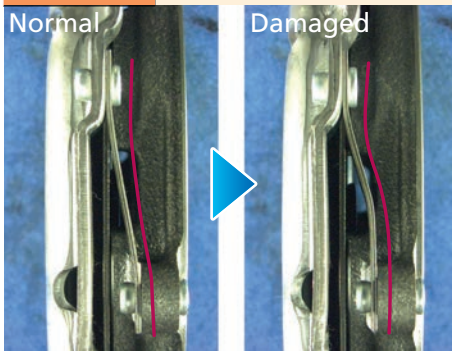

Disc Related Causes

Cover Related Causes

Other Causes

Cause:

1. Strap has been deformed or the retractable spring has been broken due to dropping the part.
2. Damaged in shipping.
3. Mishandling or installation error.

Cure:

Replace cover with new part.

Condition: Release mechanism misaligned or failed.

Disc Related Causes

Cover Related Causes

Other Causes

Cause:

1. Insufficient fluid (leaks, etc.) in clutch hydraulic parts.
2. Incorrect cable adjustment.
3. Release fork was installed incorrectly.
4. Misalignment at time of installation.

Cure:

Readjust the release mechanism.

Condition: Excessive run-out on flywheel.

Disc Related Causes

Cover Related Causes

Other Causes

Cause:

Installation error.

Cure:

Realign or replace the flywheel.

6 Troubleshooting 3

3 Shuddering and Chattering Problems (Clutch Mechanism Failure and Abnormal Friction Surface)

Condition: Oil or similar substance is on the friction surface of the facings.



Disc Related Causes

Cover Related Causes

Other Causes

Cause:

1. Facing was touched with oily hands when replacing the part.
2. Excess spline grease was thrown onto the facing due to centrifugal force.
3. Improper installation.

Cure:

1. Replace disc with new part.
2. Do not contaminate facing with oil.

Condition: The friction surface of the facings is showing heat degradation.



Disc Related Causes

Cover Related Causes

Other Causes

Cause:

1. Facing has reached the end of its wear life.
2. Facing has been scorched due to excessive partial clutch engagement, excessive 2nd gear starts, or excessive downshifting, etc.
3. Improper driving method.

Cure:

1. Replace disc and cover with new parts.
2. Improve driving method.

Condition: Abnormality seen in the friction surface of the pressure plate.

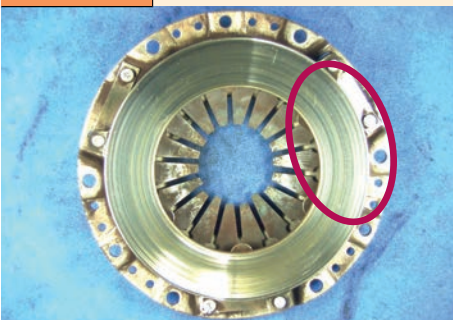

Disc Related Causes

Cover Related Causes

Other Causes

Cause:

1. Friction surface of the pressure plate has become glazed.
2. Installation error.
3. Improper driving method.

Cure:

1. Replace cover with new part.
2. Replace clutch cover when replacing disc.
3. Improve driving method.

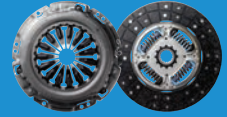

Condition: Abnormality seen in the friction surface of the flywheel.

Disc Related Causes

Cover Related Causes

Other Causes

Cause:

1. Friction surface of the flywheel has become glazed.
2. Installation error.
3. Improper driving method.

Cure:

1. Replace flywheel.
2. Inspect and service flywheel when necessary.
3. Improve driving method

6 Troubleshooting 4 5

4 Abnormal Noises and Inability to Drive (Broken Clutch)

Condition: 1. Broken disc component.

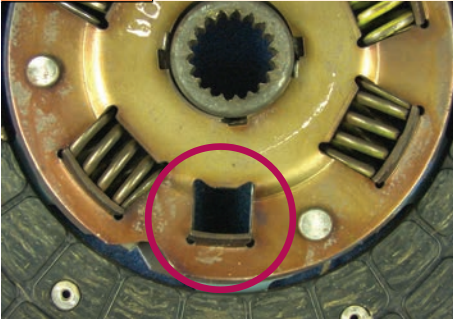

	Disc Related Causes	Cover Related Causes	Other Causes
Cause:	<ol style="list-style-type: none"> Misalignment of the crankshaft and input shaft or other problem caused disc breakage, ejecting springs and other components. Installation error. 		
Cure:	<ol style="list-style-type: none"> Replace disc and cover with new parts. Ensure centering when installing the transmission. 		

Condition: 2. Broken disc component.



	Disc Related Causes	Cover Related Causes	Other Causes
Cause:	<ol style="list-style-type: none"> Misalignment caused disc to break and engine power is not being transmitted. Installation error. 		
Cure:	Replace disc and cover with new parts.		

Condition: 3. Broken disc component.

	Disc Related Causes	Cover Related Causes	Other Causes
Cause:	<ol style="list-style-type: none"> Excessive partial clutch engagement or mis-shifting caused the facing to burst. Improper driving method. 		
Cure:	Improve driving method.		

Condition: A cover component has broken.

	Disc Related Causes	Cover Related Causes	Other Causes
Cause:	<ol style="list-style-type: none"> Significant run-out on the flywheel broke the cover's retracting spring. Improper installation. 		
Cure:	Replace flywheel with new part.		

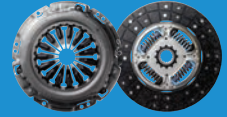

Condition: The edge of the diaphragm spring shows abnormal wear.

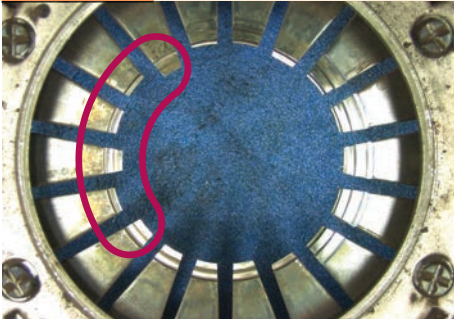

Disc Related Causes

Cover Related Causes

Other Causes

Cause:

1. Misalignment of the crankshaft and input shaft or the bearing caused the edge of the diaphragm spring to wear, preventing smooth rotation of the bearing.
2. Installation error.

Cure:

1. Replace cover with new part.
2. Ensure centering of the bearing.

5 Clutch Cover Selection Errors and Clutch Mechanism Operation Failures

Condition: Incorrect part number was installed.

Disc Related Causes

Cover Related Causes

Other Causes

Cause:

1. Wrong part was installed.
2. Incorrect part number selection.

Cure:

Replace cover with the correct part.

Condition: Malfunction of the release mechanism is causing sliding resistance.

Disc Related Causes

Cover Related Causes

Other Causes

Cause:

1. Resistance is causing rough movement of the release fork, installation rod, or cable.
2. Installation error.

Cure:

Readjust the release mechanism.



7 Precautions in Handling



Caution:

Failure to observe the following precautions could lead to clutch failure, accidents, and injury.

1. Stacking

Precaution

Do not place more than four boxes in one stack.
If there are different box sizes, place the largest on the bottom.

Reason

Inappropriate stacking can cause boxes to crush and cause clutch damage.

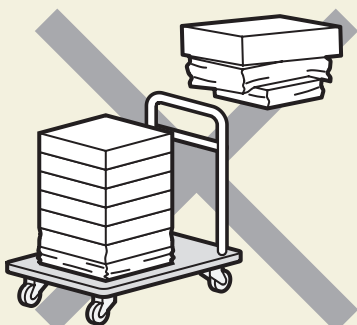

2. Product handling

Precaution

Do not use a clutch that has been dropped.

Reason

The parts that sustained the impact could be damaged and cause problems (e.g. clutch drag).

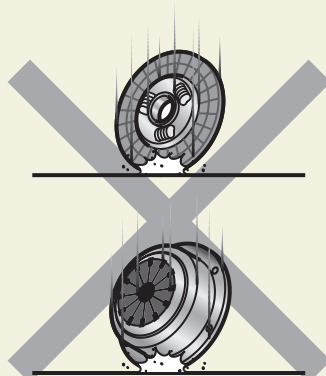

3. Product handling

Precaution

Do not use a clutch that was contaminated with water or oil.

Reason

Oil on the friction surface or rust caused by water could lead to problems (e.g. clutch drag or slipping).

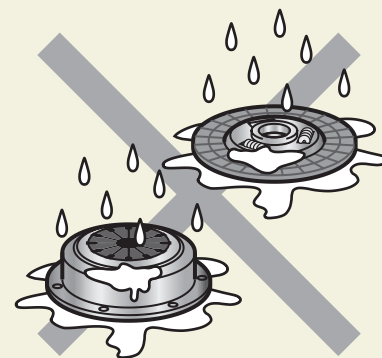

4. Disc Installation

Precaution

Remove excess grease when installing disc.

Reason

Excess grease on the friction surface can cause slipping or shuddering.

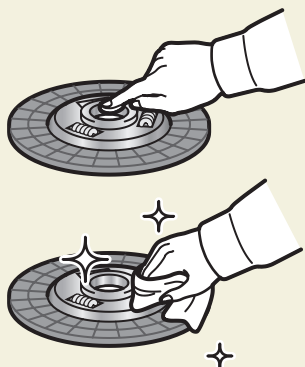

5. Cover Installation

Precaution

Tighten cover bolts in a diagonal (star) pattern. Never use an impact wrench.

Reason

If bolts are torqued in one step, an impact wrench is used, or if bolts are tightened in a circular pattern (not diagonally), it can cause clutch drag or shuddering through lever misalignment.

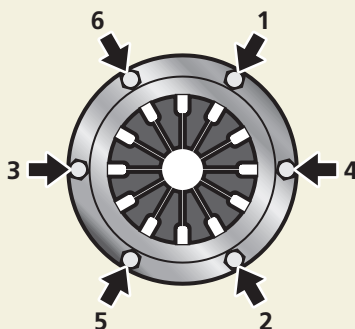

6. Cover Installation

Precaution

When tightening the cover, use bolts and torque specified from the vehicle manufacturer, using a torque wrench.

Reason

Bolts can break if the vehicle manufacturer's specified bolts are not used or not tightened to torque specifications.

