

5.11 

SPRING 2020

FULL LINE CATALOG, ISSUE 45



A.T.L.A.S.

PURPOSE-BUILT APPAREL AND GEAR FOR
LIFE'S MOST DEMANDING MISSIONS

We are innovators who make
purpose-built technical
apparel and gear for life's
most demanding missions.

5.11 ®



In 2003, we founded 5.11 Tactical® to provide purpose-built clothing and gear for the first responder and military communities. It has been our honor and privilege to serve you ever since. Today, we outfit and equip professionals and enthusiasts around the world. It's an incredibly exciting time at 5.11—filled with both product and operational innovations.

We also always listen to you. You are our primary design partner. You have to be. We work hand-in-glove with the input of top tactical professionals and the most serious technical end-users. The technologies and materials we create as a function of this partnership process are incorporated across our merchandise collection—into our clothing, our footwear, our gear—indeed, into our very brand. Our products and processes are tailored to solve mission-critical challenges and tough use cases, so what's good enough for our professional end-user is good enough for the zealous amateur.

This Spring 2020 Full Line Catalog, is packed with both core and new products, engineered to last, to look good, and to help you perform better—whatever you do. It includes the ground-breaking A.T.L.A.S. Boot System, the Prime Plate Carrier and more. We are also excited to introduce two new men's Defender-Flex pants and Apex™, ABR™ Pro and 5.11 Stryke® pants built for women.

5.11 also knows that great product is only half the equation. The other is service. So, we've invested heavily in our infrastructure and operations, including a new state-of-the-art Ops Center in Manteca, California, that raises the bar on operational excellence. The 404,000-square-foot facility is also home to The 5.11 Custom Shop, where a dedicated embellishment team customizes 5.11 uniforms to spec and delivers them ready for duty.

Respectfully,

A handwritten signature in black ink that reads "F. J. Morales".

Francisco J. Morales
CEO, 5.11 Tactical



5.11® IS A PROUD DIAMOND
ALLY OF THE FBINAA



MEN'S APPAREL **12**
 Pants 12
 Shorts 32
 Tops 42



WOMEN'S APPAREL **98**
 Bottoms 100
 Tops 114
 Outerwear 116



MEN'S OUTERWEAR **68**



UNIFORMS **120**
 Law Enforcement Dress Uniforms 122
 Tactical Duty Uniforms 136
 EMS & Fire Uniforms 146



LOGOWEAR 152

Patches 154

Hats & Socks 156

T-shirts 158



TOOLS & EVERY DAY CARRY 186

Belts & Wallets 188

Tools, Lights & Gloves 196

Breaching Equipment 210



FOOTWEAR 162

Boots 164

Socks 184



LOAD BEARING GEAR 212

Carriers & Platforms 214

Pouches Plus 226

Packs & Bags 232

FULL INDEX 286



5.11 PERFORMANCE FABRICS



MOVE MORE:
Mechanical stretch fabric provides lasting durability that moves with you.

WEARS STRONGER:
Fabric is manufactured for maximum durability to stand up to hard-use.

RESIST ELEMENTS:
Teflon™ finish resists water, dirt and stains for longer wear.



WEARS STRONGER:
Fabric is manufactured for maximum durability to stand up to hard-use.

RESPOND FASTER:
Lighter weight fabric for maximum performance and movement.

STAYS SMOOTH:
Fabric is engineered to avoid snagging for long-term durability and easy wear.



RESPOND FASTER:
Lighter weight fabric for maximum performance and movement.

MOVE MORE:
Mechanical stretch fabric provides lasting durability that moves with you.

RESIST ELEMENTS:
DWR finish resists water, dirt and stains for longer wear.

5.11 FABRIC FEATURES



Fabric is engineered to avoid snagging for long-term durability and easy wear while retaining its ability to move and stretch.

Achieved through fabrics that offer both stretch characteristics and durability.



Provides superior evaporation and heat management for comfort in hot and humid conditions.

Achieved through fabrics and construction methods that allow greater airflow and breathability.

FAVORITE FEATURES



STRETCH Our favorite feature. Fabrics engineered for flexibility and movement to keep you comfortable and always ready.



READY POCKET™ 5.11's patented chest pocket design (internal or external). Store your phone, notebook, plane tickets or other essentials within easy reach.



PHONE POCKET Pockets built for easy carry of your phone or other items, perhaps even a rifle or pistol magazine or two.



RAPIDDRAW Designed and built with features to allow the fast presentation of a concealed sidearm.



ID PANELS Built with customizable ID panels that can be stowed away or shown for agency identification.



PACKABLE Jackets that pack into their own pockets. Stow away in your vehicle or luggage to be ready for changing weather.

MEN'S & WOMEN'S TOP FIT

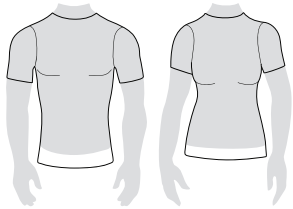
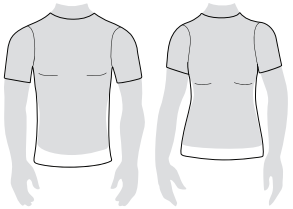
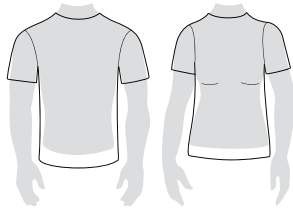
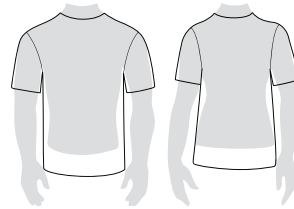
 <p>COMPRESSION</p>	 <p>FITTED</p>	 <p>REGULAR</p>	 <p>CLASSIC</p>
<p>A tight, compressive fit.</p>	<p>A body skimming fit. Non-compressive.</p>	<p>A comfortable, professional fit. Neither slim nor oversized.</p>	<p>A full, generous fit allowing superior range of motion.</p>

MEN'S BOTTOM FITS

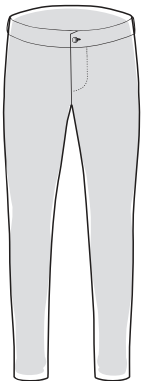
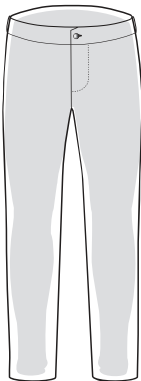
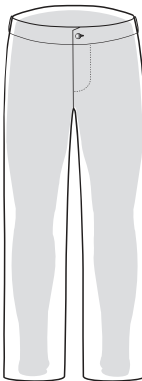
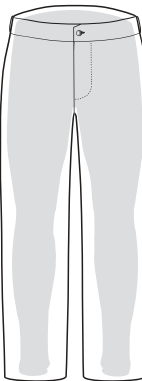
 <p>SKINNY</p>	 <p>SLIM</p>	 <p>STRAIGHT</p>	 <p>RELAXED</p>
<p>Skinny fit from waist to leg opening. (Not currently a 5.11 men's fit.)</p>	<p>Slim fit from waist to knee. Straight from knee to leg opening.</p>	<p>Straight fit from waist to leg opening.</p>	<p>Our most generous fit from waist to knee. Straight from knee to leg opening.</p>

WOMEN'S BOTTOM FITS

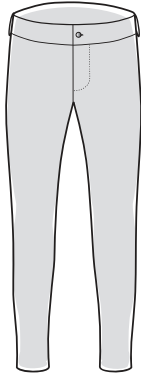
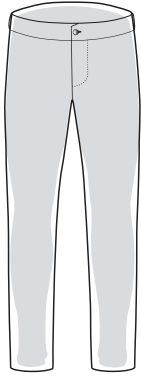
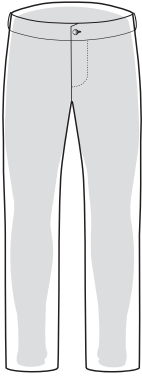
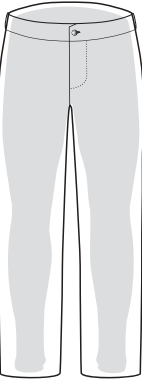
 <p>SKINNY</p>	 <p>SLIM</p>	 <p>STRAIGHT</p>	 <p>RELAXED</p>
<p>Mid-rise with a skinny fit from hip to leg opening.</p>	<p>Mid-rise with a slim fit through hip and thigh. Straight from knee to leg opening.</p>	<p>Mid-rise with a straight fit from hip to leg opening.</p>	<p>Mid-rise with our most generous fit through hip and thigh. Straight from knee to leg opening.</p>

SIZING INSTRUCTIONS

Using a measuring tape, measure your body (not over clothing) and refer to these body charts to determine the best size. If you fall between sizes, we recommend ordering the larger size.

Men: Use your chest, arm length and neck measurements to determine the proper size for tops and outerwear; use your waist measurement (where you wear your pants) for bottoms and belts.

Women: Use your chest measurement to determine the proper size for tops and outerwear; use your waist (smallest point) and hip measurements for bottoms; use your waist measurement (where you wear your pants) for belts.

HOW TO MEASURE YOUR BODY

Chest: Measure under arms and around the fullest part of your chest with measuring tape parallel to the floor.

Waist: Measure around the natural part of your waist (Men - where you wear your pants / Women - the smallest part of your waist).

Neck: Measure around the base of your neck.

Hip: Stand with your feet together and measure around the fullest part of your hip with the measuring tape parallel to the floor.

Arm Length: Slightly bend elbow and measure from center back neck, over top of shoulder and down to wrist.

Inseam: Measure inside of leg from crotch to ankle or desired length.

MEN'S BODY MEASUREMENTS

Alpha Size	XS		S		M		L		XL		2XL		3XL		4XL		5XL		6XL	
Neck	13	13 ½	14	14 ½	15	15 ½	16	16 ½	17	17 ½	18	18 ½	19	19 ½	20	20 ½	21	21 ½	22	22 ½
Chest	30	32	34	36	38	40	42	44	46	48	50	52	54	56	58	60	62	64	66	68
Arm Length*	32 ¼	32 ¾	33	33 ½	33 ¾	34 ¼	34 ½	35	35 ¾	35 ¾	36	36 ½	36 ¾	37 ¼	37 ½	38	38 ¾	38 ¾	39	39 ½
Waist	24	26	28	30	32	34	36	38	40	42	44	46	48	50	52	54	56	58	60	62

Short = 5'3"-5'7½", Regular = 5'8"-6'½", Tall = 6'1"-6'3", Short sizes have 2" reduced from body and sleeve length. Tall sizes have 2" added to body and sleeve length.

*Arm length refers to your actual arm length, not the garment's sleeve length.

WOMEN'S BODY MEASUREMENTS

Alpha Size	X-Small		Small		Medium		Large		X-Large		1X		2X		3X		4X	
Numeric Size	0	2	4	6	8	10	12	14	16	18	16	18	20	22	24	26	28	30
Chest	32 ½	33 ½	34 ½	35 ½	36 ½	37 ½	39	40 ½	42 ½	44 ½	43	45	47	49	51	53	55	57
Arm Length*	29 ½	29 ¾	30 ¾	30 ¾	31	31 ¼	31 ¾	32	32 ½	32 ¾	33 ¾	33 ¾	33 ¾	34	34 ¾	34 ¾	34 ¾	35
Waist	25	26	27	28	29	30	31 ½	33	35	37	36	38	40	42	44	46	48	50
Hip	35 ½	36 ½	37 ½	38 ½	39 ½	40 ½	42	43 ½	45 ½	47 ½	45	47	49	51	53	55	57	59

Regular = 5'5"-5'7", Tall = 5'8"-5'11", Tall sizes have 2" added to body length and 1 ½" added to sleeve length.

*Arm length refers to your actual arm length, not the garment's sleeve length.

WOMEN'S EXTENDED SIZES

Alpha Size	1X		2X		3X		4X	
Numeric Size	16	18	20	22	24	26	28	30
Chest	43	45	47	49	51	53	55	57
Arm Length*	33 ¾	33 ¾	33 ¾	34	34 ¾	34 ¾	34 ¾	35
Waist	36	38	40	42	44	46	48	50
Hip	45	47	49	51	53	55	57	59

Regular = 5'5"-5'7", Tall = 5'8"-5'11", Tall sizes have 2" added to body and sleeve length.

MEN'S FOOTWEAR SIZE CONVERSIONS

US Size	4	5	6	6 ½	7	7 ½	8	8 ½	9	9 ½	10	10 ½	11	11 ½	12	13	14	15
UK Size	3	4	5	5 ½	6	6 ½	7	7 ½	8	8 ½	9	9 ½	10	10 ½	11	12	13	14
EU Size	37	37 ½	38 ½	39	40	40 ½	41	42	42 ½	43	44	44 ½	45	45 ½	46	47 ½	48 ½	49 ½

Wide available in US Sizes 7-12, 13

WOMEN'S FOOTWEAR SIZE CONVERSIONS

US Size	5	6	6 ½	7	7 ½	8	8 ½	9	9 ½	10
UK Size	4	4 ½	5	5 ½	6	6 ½	7	7 ½	8	8 ½
EU Size	37	37 ½	38	38 ½	39	40	40 ½	41	42	42 ½

GLOVE SIZING

Unisex Size	S	M	L	XL	2XL
Men's	78 mm	90 mm	103 mm	114 mm	127 mm

Measure across the palm of your hand from where your thumb and index meet.

PRODUCT DETAILS, PRICES, AND AVAILABILITY ARE SUBJECT TO CHANGE WITHOUT NOTICE.

HAT SIZING

Hat Size	Measurement	A-Flex	One Size
7	22" / 55.8 cm	-	-
7 1/8	22 3/8" / 56.8 cm	-	-
7 1/4	22 3/4" / 57.7 cm	-	-
7 3/8	23 1/8" / 58.7 cm	-	-
7 1/2	23 1/2" / 59.6 cm	-	-
7 5/8	23 7/8" / 60.6 cm	-	-
7 3/4	24 1/4" / 61.5 cm	-	-
7 7/8	24 5/8" / 62.5 cm	-	-

NOTICE: "5.11", "5.11 [+]", "[+]", "Always Be Ready" and their corresponding logomarks are registered trademarks of 5.11, Inc.

OPS CENTER

MANTECA, CA



OPS CENTER OVERVIEW

- 404,000 sq. ft. with room for another 100,000
 - Modesto/Lathrop was 275,000 combined
- More than 50 dock doors
 - Modesto had 5 doors total
- The Pick Module is approximately 45,000 sq. ft.
 - Twice as many packing stations
- Automated shipping sorters streamline product handling
- High-density VNA racking with computer-aided forklifts
- Sophisticated new data system (AX), robust reporting
- Training room, product library and product showroom
- Employee breakroom and gym

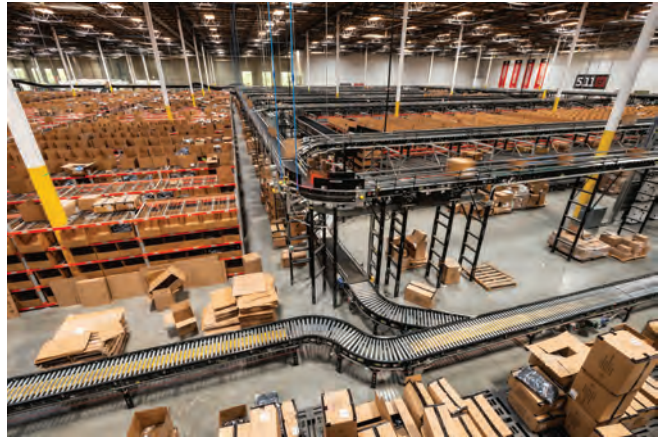



CUSTOM SHOP 2.0

The new 5.11 Custom Shop has a peak output of more than 3000 units per day. That's more than double our previous facility. We've made a multi-million dollar investment in new equipment throughout the entire facility. Our Custom Shop Team knows embellishment, knows our product like none other and is dedicated to finding the best solution for your branded 5.11 apparel and gear.



- 90 fully redundant embroidery heads
- New capabilities for font embroidery
- Machine performance tracking
- 19 automatic sewing machines for alterations, production times are halved
- Two 14-color automatic screen presses
- Large format heat press plotters
- Engraving now features 10X the output with two CO₂/Fiber Laser Engravers

MEN'S PANTS

Ultimate functionality,
determined durability and
comfortable wear

Left: New Icon Pant (p 20)
Right: Apex® Pant (p 24)



**NEW****DEFENDER FLEX RANGE PANT**

SLIM FIT



This is the Defender-Flex Range Pant. It continues the high performance tradition of our bestselling Defender Flex Pants and Jeans. Designed for end users desiring tactical options in a comfortable and casual-looking pant. It presents a five pocket slim fit jean style plus two additional back mag/phone pockets, with reinforced belt loops to support a gunbelt or EDC/CCW belt. Pockets are rivet reinforced and Nylon 6 has been incorporated into the front hand pockets for durability.

- + 8.3-oz., enzyme washed 97% cotton / 3% elastane canvas
- + 5-pocket denim styling plus back yoke pockets
- + Fitted waistband

74517 Defender-Flex Range Pant | Khaki 055, Brown Duck 080, Ranger Green 186 | 28, 30, 31, 32, 33, 34, 35, 36-40 even waist, 28-36 even inseams

KHAKE 055

BROWN DUCK 080

RANGER GREEN 186



STRETCH



PHONE POCKET



NEW

DEFENDER FLEX URBAN PANT

SLIM FIT

The Defender-Flex Urban Pant incorporates needs and wants expressed after the success of the Defender-Flex Jean series. It gives you a pant with all the features that made its predecessors so successful, but with a look that makes it more appropriate for office wear or an enjoyable evening out (jacket, no tie).

Flex-Tac® stretch twill means you can move in them; the stain- and soil-resistant Teflon™ finish eliminate worries about what you'll get into when you do. The Defender-Flex Urban Pant has five pockets, plus two extra back mag pockets in case you're called upon to do work. The belt loops are reinforced for durability, as are the front hand pockets.

- + 7.3-oz., 68% polyester / 32% cotton Flex-Tac® twill, rinse washed
- + Teflon™ finish for stain and soil resistance
- + 5-pocket denim styling plus back yoke pockets
- + Fitted waistband

74525 Defender-Flex Urban Pant | Black 019, Flint 258, Peacoat 787 | 28, 30, 31, 32, 33, 34, 35, 36-40 even waist, 28-36 even inseams |

BLACK 019

FLINT 258

PEACOCK 787





KNIFE/MAGAZINE
POCKET

REAR PHONE/MAG
POCKETS

STRETCH DENIM

REINFORCED
CONSTRUCTION

DARK WASH INDIGO
PICTURED

SLIM FIT

DEFENDER FLEX JEAN SLIM FIT SLIM FIT



Whether it's a weekend in the backcountry or a night out on the town, the Defender-Flex Jean rolls with you while its slim fit offers a contemporary profile. An innovative cotton/polyester (Lycra® T400 Tough Max) mechanical stretch denim means better stretch and recovery. Five pocket styling plus two mag pockets up your tactical game. Imported.

- + 10-oz., 76% cotton / 24% polyester with Lycra® T400 Tough Max™ mechanical stretch denim
- + 5-pocket denim styling plus back yoke pockets
- + Fitted waistband

74465 Defender-Flex Jean, Slim Fit | Black 019 (solid color), Dark Wash Indigo 649, Indigo 718 (solid color) | 28, 30, 31, 32, 33, 34, 35, 36, 38, 40 waist, 30-36 even inseams

BLACK 019

DW INDIGO 649

INDIGO 718

 STRETCH  PHONE POCKET

KNIFE/MAGAZINE
POCKET

REAR PHONE/MAG
POCKETS

REINFORCED
CONSTRUCTION

STRETCH DENIM

STRAIGHT FIT

DEFENDER FLEX JEAN STRAIGHT FIT STRAIGHT FIT



Built with the same cotton/polyester (Lycra® T400 Tough Max) mechanical stretch denim as the Defender Flex Slim Fit, the Defender Flex Jean Straight Fit offers a slightly relaxed profile from the thigh down. Five pocket styling plus two mag pockets keep you organized and ready. Imported.

- + 10 oz. mechanical stretch denim (76% cotton / 24% polyester with Lycra® T400 Tough Max™)
- + 5-pocket denim styling plus back yoke pockets
- + Fitted waistband

74477 Defender-Flex Jean, Straight Fit | Dark Wash Indigo 649 | 28, 30, 31, 32, 33, 34, 35, 36, 38, 40, 42, 44 waist, 30-36 even inseams |



STRETCH PHONE POCKET

KNIFE/MAGAZINE
POCKET

REAR PHONE/MAG
POCKETS

ANGLED LOW-PROFILE
CARGO POCKETS

FLEX-TAC®
CANVAS

SLIM FIT



CAPITAL PANT SLIM FIT

Low-profile style meets high-level tactical functionality in the Capital Pant. It's built for toughness and freedom of movement, featuring our polyester/cotton Flex-Tac® canvas fabric with a Teflon™ finish to ward off stains and soiling. The comfort waistband moves with you, and works with you: It features a flex cuff tunnel and cuff key pocket. Discreet mag pockets at the back yoke and low-pro cargo pockets add utility that won't get in your way. This pant will look sharp with everything from an untucked tee to a 5.11 button-up and a blazer. Imported.

- + 6.4-oz., 67% polyester / 33% cotton, Flex-Tac® canvas with Teflon™
- + 11 pockets, including rear yoke pockets
- + Comfort waistband w/ flex cuff tunnel and cuff key pocket

74524 Capital Pant | Black 019, Stone 070, Ranger Green 186, Flint 258, Major Brown 367, Peacoat 787 | 30, 31, 32, 33, 34, 35, 36, 38, 40 waist; 28-36 even inseams |

BLACK 019	STONE 070	RANGER GREEN 186
FLINT 258	MAJOR BROWN 367	PEACOCK 787

 STRETCH  PHONE POCKET



QUEST PANT STRAIGHT FIT



Just like anyone else, you pull the Quest Pant on one leg at a time. But something kicks in when you realize you're wearing such a great fitting, flexible, CCW-ready pant. The Quest features articulated knee and gusseted construction, and it's built with stretch fabric and stretch panels in the waistband. Basically, however you need to move, the Quest moves with you. It has 8 pockets, too, including hidden rear hip pockets, so carrying your must-have portables is no problem. Gear up and get ready to conquer with the Quest Pant. Imported.

74510 Quest Pant | Lunar 082, Kangaroo 134, Ranger Green 186, Major Brown 367 | 28, 30, 31, 32, 33, 34, 35, 36, 38, 40, 42, 44 waist; 30-36 even inseams |

LUNAR 082	KANGAROO 134	RANGER GREEN 186
MAJOR BROWN 367	STRETCH PHONE POCKET	

- + Main fabric: 6.4-oz., 80% cotton / 18% polyester / 2% elastane Supreme twill, sanded finish with an enzyme and stone wash
- + Overlay fabric: 8.3-oz., 97% cotton / 3% elastane stretch canvas

THE ICON

The 5.11 Stryke® Pant's slim-fit brother, same flexibility and functional cargo pockets with a thinner leg profile.



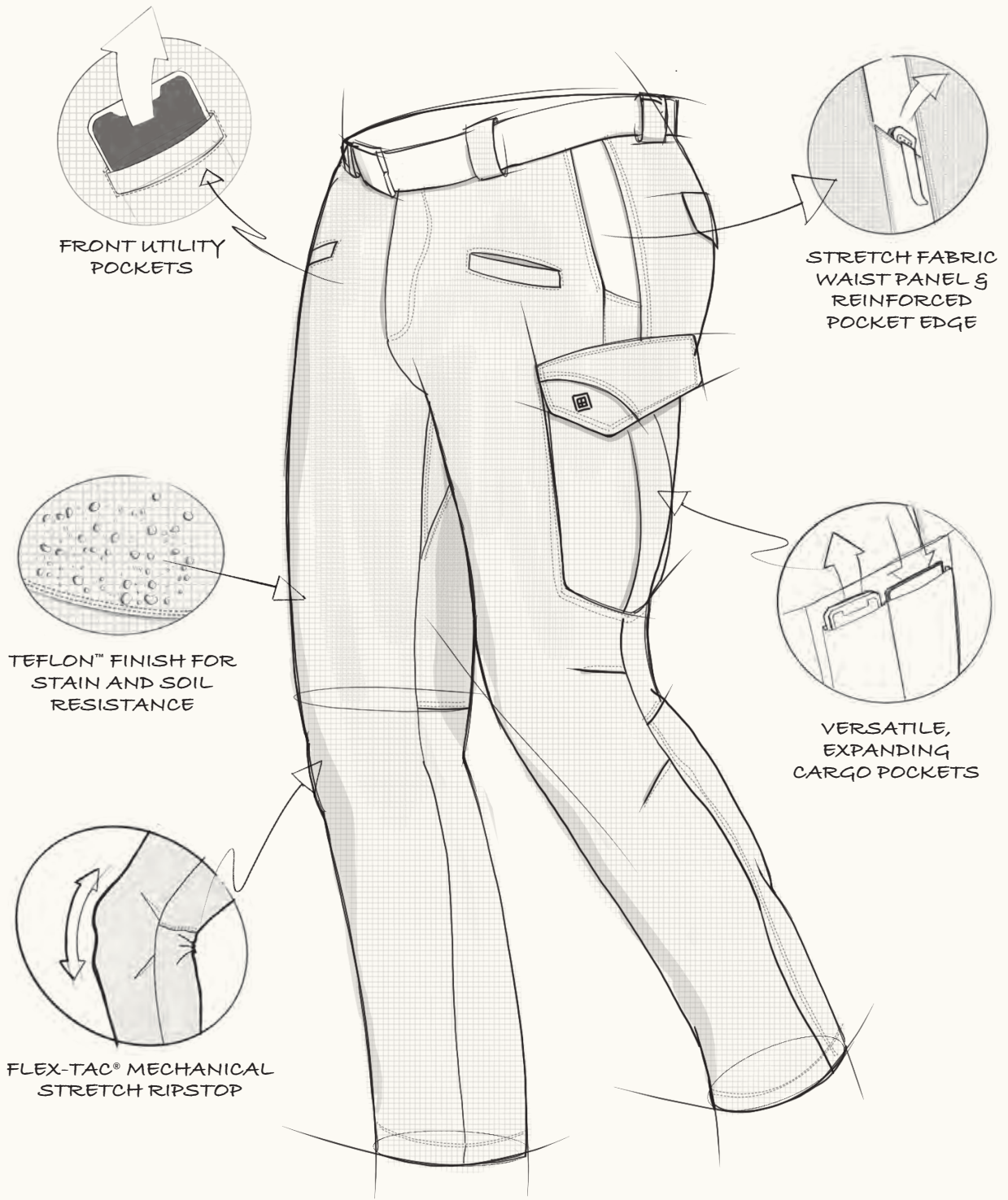

FRONT UTILITY
POCKETS

STRETCH FABRIC
WAIST PANEL &
REINFORCED
POCKET EDGE

TEFLON™ FINISH FOR
STAIN AND SOIL
RESISTANCE

VERSATILE,
EXPANDING
CARGO POCKETS

FLEX-TAC® MECHANICAL
STRETCH RIPSTOP

PHONE/MAG
POCKETS

SELF-ADJUSTING
TUNNEL WAISTBAND

CARGO POCKETS
WITH DIVIDERS

GUSSETED
CONSTRUCTION

FLEX-TAC®
STRETCH RIPSTOP

SLIM FIT



ICON PANT SLIM FIT

Need a cargo pant? The Icon is that and a ton more. Let's start with sturdy utility: you've got cargo pockets with internal dividers to keep things separated. You've got front utility pockets and hand pockets, too – all reinforced with mega-strong nylon 6 fabric. You have a diamond gusset and knee articulation to add range to your motion. And what about the materials' breakdown of this pant? Imported.

- + 80% polyester/20% cotton mechanical stretch Flex-Tac® ripstop, 6.8 oz., with Teflon™ finish
- + Cargo pockets w/inside dividers, rear yoke pockets
- + Comfort waistband

74521 Icon Pant | Black 019, Khaki 055, Kangaroo 134, Ranger Green 186, Flint 258, Dark Navy 724 | 28, 30, 31, 32, 33, 34, 35, 36, 38, 40 waist; 28-36 even inseams |

BLACK 019	KHAKI 055	KANGAROO 134
RANGER GREEN 186	FLINT 258	DARK NAVY 724

 STRETCH  PHONE POCKET



5.11 STRYKE® PANT STRAIGHT FIT

The 5.11 Stryke Pant is what all other pants want to be. Made of our patent-pending two-way Flex-Tac® mechanical stretch fabric, finished with stain- and soil-resistant Teflon™, the 5.11 Stryke pant is exceptionally durable. With 12 pockets, reinforcements in strategic places, and a self-adjusting waistband (men's only). Imported.

- + 6.8-oz. 65% polyester / 35% cotton Flex-Tac® mechanical stretch ripstop with Teflon™ finish for stain and soil resistance
- + 12 pockets, cargo pockets feature internal organization
- + Self-adjusting waistband

74369 5.11 Stryke Pant | Charcoal 018, Black 019, Khaki 055, Stone 070, Storm 092, Battle Brown 116, Burnt 117, Coyote 120, Ranger Green 186, TDU Green 190, Tundra 192, Dark Navy 724 | 28-44 even sizes, 30-36 even inseams (46-54 unhemmed)

CHARCOAL 018	BLACK 019	KHAKI 055	STONE 070	STORM 092
BATTLE BROWN 116	BURNT 117	COYOTE 120	RANGER GREEN 186	TDU GREEN 190
TUNDRA 192	DARK NAVY 724	STRETCH		PHONE POCKET

THE APEX

With Flex-Tac® mechanical stretch canvas and a low-profile cargo pocket, the Apex Pant is ready get you there and back.



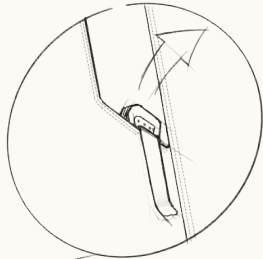
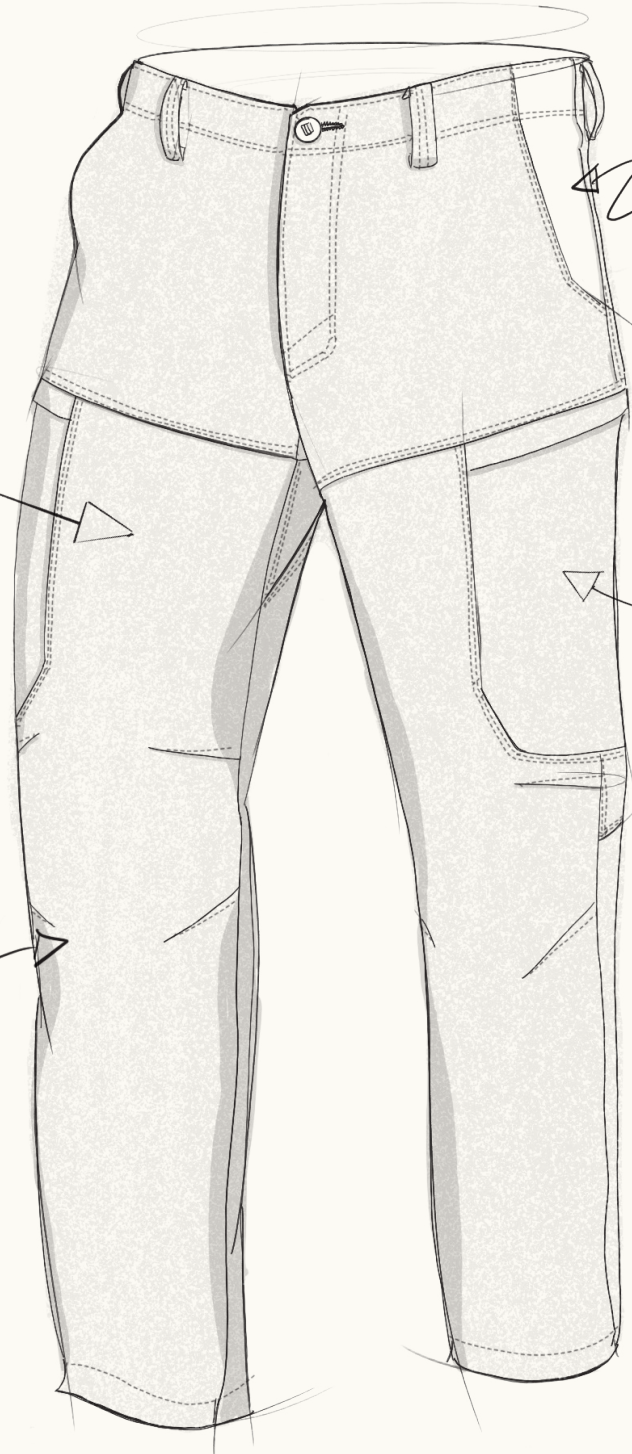

STRETCH FABRIC
WAIST PANEL &
REINFORCED
POCKET EDGE

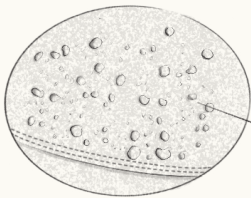

TEFLON™ FINISH FOR
STAIN AND SOIL
RESISTANCE

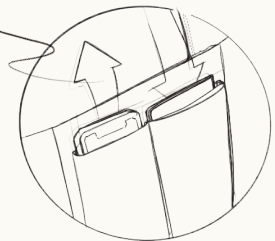

LOW-PROFILE
CARGO POCKETS W/
INTERNAL ORG

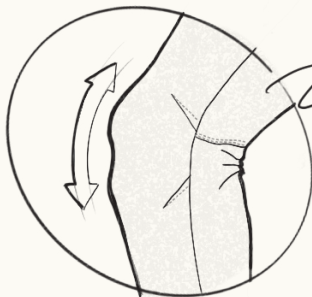

FLEX-TAC® MECHANICAL
STRETCH CANVAS



APEX™ PANT STRAIGHT FIT

Flexible and functional, the Apex Pant sets the standard for speed and versatility with 5.11®'s Flex-Tac® mechanical stretch canvas. Featuring a CCW-ready comfort waistband, an internal flex cuff pocket, hidden handcuff key pocket, zippered thigh pockets with internal magazine storage, and deep, reinforced main pockets, the Apex Pant is made for action. Gusseted construction, articulated knees, and a Teflon™ finish for stain- and soil-resistance, they're also made to be worn. Imported.

- + 6.4-oz., 67% polyester / 33% cotton Flex-Tac® mechanical stretch canvas with a Teflon™ finish.
- + 10 pockets including low-profile cargo pockets
- + Comfort waistband w/ flex cuff tunnel

74434 Apex Pant | Black 019, Khaki 055, Storm 092, Volcanic 098, Battle Brown 116, Burnt 117, Ranger Green 186, TDU Green 190, Tundra 192, Dark Navy 724 | 30, 31, 32, 33, 34, 35, 36, 38, 40, 42, 44 waist, 30-36 even inseams |

BLACK 019	KHAKE 055	STORM 092	VOLCANIC 098	BATTLE BRN 116
BURNT 117	RANGER GRN 186	TDU GREEN 190	TUNDRA 192	DARK NAVY 724

 STRETCH  PHONE POCKET



ABR™ PRO PANT **STRAIGHT FIT**

Because we have to keep innovating to keep up with you, the next evolution of the 5.11 Tactical pant is here. The device ready ABR™ Pro Pant packs a mean tactical punch, with 9 total pockets, reinforced seat and knees and our trademark utility strap. And it's all rolled into a relaxed, straight-fit profile. Made with our remarkably rugged, yet light poly/cotton FlexLite Ripstop with mechanical stretch, the ABR™ Pro Pant delivers the ultimate combination of easy-to-wear, durable tactical style. Imported.

- + 5.6-oz., 71% polyester / 29% cotton FlexLite ripstop with Teflon™
- + 9 pockets including our trademarked strap and slash seat pockets
- + Comfort waistband

74512 ABR™ Pro Pant | Black 019, Khaki 055, Kangaroo 134, Ranger Green 186, Dark Navy 724 | 28, 30, 31, 32, 33, 34, 35, 36, 38, 40, 42, 44 waist, 30-36 even inseams |

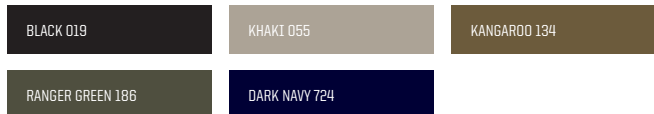

STRETCH PHONE POCKET



TACLITE® PRO PANT **RELAXED FIT**

The Taclite® Pro Pant features eight pockets, our durable ripstop fabric, and a Teflon™ finish for stain- and soil-resistance. Double reinforced at the seat and knees mean these pants won't wear out, no matter how much sitting, hustling, and crawling through the brush you do. If you've ever wondered what it's like to wear comfortable, invincible pants, here's your opportunity. Imported.

- + 6.2-oz., 65% polyester / 35% cotton Taclite® ripstop with Teflon™
- + 8 pockets including our trademarked strap and slash seat pockets
- + Action waistband

74273 Taclite Pro Pant | Charcoal 018, Black 019, Stone 070, Storm 092, Battle Brown 116, Coyote 120, TDU Khaki 162, TDU Green 190, Tundra 192, Dark Navy 724 | 28-44 even sizes, 30-36 even inseams

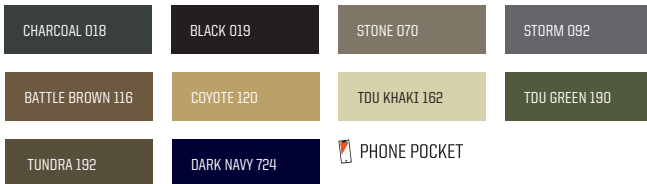



NEW
DELTA PANT SLIM FIT



Lightweight with stretch and versatility built in, the Delta pant has a DWR finish that offers stain and soil resistance. Of the Delta Pant's nine pockets, four - the cargo pockets and back pockets - are zip secured to hold your immediate necessities secure. Two more pockets have been hidden away at the rear, and the hand pockets have been reinforced with Nylon 6. Imported.

- + 5.5-oz. 89% polyester / 11% elastane double weave with Enduro-Flex™ properties, DWR finish
- + 9 pockets, including back yoke pockets and front thigh pockets
- + Fixed waist with inside elastic and flex-cuff tunnel

74526 Delta Pant | Black 019, Stone 070, Ranger Green 186, Flint 258, Peacoat 787 | 28, 30, 31, 32, 33, 34, 35, 36-40 even waist, 28-36 even inseams |

BLACK 019	STONE 070	RANGER GREEN 186
FLINT 258	PEACOAT 787	

-  STRETCH
-  PHONE POCKET



BRAVO PANT SLIM FIT

The Bravo is crafted with a super-lightweight, ultimately flexible fabric blend with a durable water-repellent finish. The Bravo supports your range of motion in the waist, via a fixed waistband with soft jacquard logo elastic, and at the knees, which feature articulated backs. And for all your stuff, there are 7 total pockets, including nylon-6-reinforced hand pockets, plus back pockets, and two back yoke utility pockets. Reflective trim on the inner side seam. Imported.

- + 5.5-oz., 89% polyester / 11% elastane 4-way stretch double weave fabric with Enduro-Flex™ properties and DWR finish
- + 7 total pockets, including back yoke pockets
- + Fixed waistband with soft inside jacquard logo elastic

74522 Bravo Pant | Black 019, Stone 070, Ranger Green 186, Peacoat 787 | 30, 31, 32, 33, 34, 35, 36, 38, 40 waist; 28-36 even inseams |

BLACK 019	STONE 070	RANGER GREEN 186
PEACOCK 787		

STRETCH PHONE POCKET



EDGE CHINO SLIM FIT

The chino gets a tactical style upgrade in the Edge Chino Pant. The perfect way to look sharp, even on a business-casual day, the Edge Chino is built for comfort and staying power. We started with 5.11's Flex-Tac® 68% polyester/32% cotton fabric in a twill weave and finished it with Teflon™ for stain and soil resistance. This pant has 7 total pockets, including slash hand pockets with a little attitude, rear yoke utility pockets and a device ready pocket for phone storage. Imported.

- + 7.3-oz., 68% poly / 32% cotton Flex-Tac® twill with a Teflon™ finish
- + 7 pockets, including back yoke pockets and front phone pocket
- + Fitted waistband

74481 Edge Chino Pant | Black 019, Stone 070, Flint 258, Dark Navy 724 | 28, 30, 31, 32, 33, 34, 35, 36, 38, 40, 42, 44 waist sizes, 30-36 even inseams |

BLACK 019	STONE 070	FLINT 258
DARK NAVY 724	STRETCH	PHONE POCKET



FAST-TAC™ CARGO PANT

STRAIGHT FIT

Load up the Fast-Tac Cargo Pant and go! Its 4.7-oz. performance polyester ripstop fabric features a WR finish for water resistance and is double and triple stitched throughout. Back yoke utility pockets, cargo pockets, rear pockets plus a Device-Ready front utility pocket give you nine places to store your EDC gear. Imported.

- + 4.7-oz. 100% polyester Fast-Tac™ ripstop fabric with WR finish
- + 9 pockets, including back yoke pockets and thigh cargo pockets
- + Flexible self-adjusting waistband

74439 Fast-Tac™ Cargo Pant | Charcoal 018, Black 019, Khaki 055, Battle Brown 116, Dark Navy 724 | 28-44 even waist sizes, 30-36 even inseams. (Select colors in sizes 46-54, 30-34 even inseams for

CHARCOAL 018	BLACK 019	KHAKI 055
BATTLE BROWN 116	DARK NAVY 724	 PHONE POCKET



FAST-TAC™ URBAN PANT

STRAIGHT FIT

Versatile and everyday-ready, the Fast-Tac Urban Pant rolls with the punches. A flexible, 7-loop waistband, reinforced pockets and 4.7-oz. polyester ripstop fabric with a WR finish make this an easy wearing, lightweight and breathable pant. Imported.

- + 4.7-oz. 100% polyester Fast-Tac™ ripstop fabric with WR finish
- + 5 pockets, including back yoke pockets and front phone pocket
- + Flexible self-adjusting waistband

74461 Fast-Tac™ Urban Pant | Charcoal 018, Black 019, Khaki 055, Battle Brown 116, Dark Navy 724 | 28-44 even waist sizes, 30-36 even inseams. (Select colors in sizes 46-54, 30-34 even inseams

CHARCOAL 018	BLACK 019	KHAKI 055
BATTLE BROWN 116	DARK NAVY 724	 PHONE POCKET



5.11 TACTICAL® PANT RELAXED FIT



The first tactical pant—the true original that’s been serving public safety professionals for decades. Made of 100% cotton canvas, the 5.11 Tactical Pant is constructed for superior durability, comfort, and performance. Featuring our trademarked strap-and-slash pockets, an adjustable waist, double-reinforcement at the seat and knees, and heavy stitching. There’s only one original. Imported.

- + 8.8-oz., 100% cotton canvas
- + 7 pockets including our trademarked strap-and-slash seat pockets
- + Action waistband

74251 5.11 Tactical Pant | Black 019, Grey 029, Khaki 055, Coyote 120, OD Green 182, Tundra 192, Fire Navy 720 | 28-44 even sizes, 30-36 even inseams (select colors in sizes 46-54 unhemmed for 74252 GSA 5.11 Tactical Pant available in Black and Khaki

BLACK 019	GREY 029	KHAKI 055
COYOTE 120	OD GREEN 182	TUNDRA 192
FIRE NAVY 720		



5.11 RECON® POWER TRACK PANT SLIM FIT

You don’t have to run a crazy-fast 40-yard dash to wear the RECON Power Track Pant. You just have to prefer casual, yet streamlined style with light utility built in. Stretchy, snag-resistant fabric means this pant will stand up to your workout or day out, for as long as you want to push it. The front hand pockets are built with a welded zipper closure to keep your keys, phone or ID from flying away while you’re running in the fast land or outmaneuvering the competition. No matter what your day entails, your look will last, with the draw cord waistband to keep the pant in place. Imported.

- + 8.8-oz., 90% polyester / 10% elastane terry
- + Welded front hand zipper pockets, back welt pocket
- + Draw cord waistband

82405 5.11 RECON® Power Track Pant | Black 019, Ranger Green 186, Pacific Navy 721 | XS-2XL |

BLACK 019	RANGER GREEN 186	PACIFIC NAVY 721
-----------	------------------	------------------



MEN'S SHORTS

From rugged cargo shorts with loads of pockets to comfortable and casual shorts, we have a flexible solution for you.



5.11 Stryke® Short in action, worn by a member of the Dakar Media team.





APEX™ SHORT

11" INSEAM

Built for everyday tactical and casual wear, the Apex Short features our Flex-Tac® mechanical stretch canvas with a Teflon™ finish. Low-profile cargo pockets, internal flex-cuff and handcuff key pockets add tactical functionality.

- + 6.4-oz., 67% poly / 33% cotton Flex-Tac® mechanical stretch ripstop
- + Teflon™ finish for stain and soil resistance
- + 10 pockets including low-profile cargo pockets
- + Comfort waistband w/ flex cuff tunnel

73334 Apex Short | 11" inseam | Black 019, Khaki 055, Battle Brown 116, TDU Green 190, Dark Navy 724 | 28-44 even waist sizes |

BLACK 019

KHAKI 055

BATTLE BROWN 116

TDU GREEN 190

DARK NAVY 724



STRETCH



PHONE POCKET



NEW

ABR™ PRO SHORT

11" INSEAM

The ABR Pro Short is an updated tactical/cargo short style made with our proprietary stretchable FlexLite™ ripsop fabric. Tough enough for more than your bare legs below could possibly stand, the ABR Pro Short has a double reinforced seat, Nylon 6 reinforcement in select pockets, and a 5.11 logo D-ring at the front belt loop. Imported.

- + 5.4-oz., 71% polyester / 29% cotton FlexLite™ ripstop with Teflon™ finish
- + 9 pockets, including back yoke pockets
- + Comfort waist

73349 ABR™ Pro Short | 11" Inseam | Black 019, Khaki 055, Kangaroo 134, Ranger Green 186, Dark Navy 724 | 28, 30, 31, 32, 33, 34, 35, 36-44 even waist |

BLACK 019	KHAKI 055	KANGAROO 134
RANGER GREEN 186	DARK NAVY 724	

STRETCH PHONE POCKET



NEW

STEALTH SHORT

10-1/2" INSEAM

The Stealth Short is one unique garment - a pair of shorts as suitable for ninjas as it is for trail runners and bicycle cops. They have a total of nine pockets, including zip-secured cargo pockets, hook-and-loop closed back pockets, and a pair of back yoke utility pockets. Are these the same? The hand pockets are reinforced with Nylon 6 and - should you need it - a hidden flexi-cuff tunnel inside the waistband.

- + 3.3-oz., 100% polyester mechanical stretch fabric with Enduro-Flex™ properties and a moisture-wicking finish
- + 9 pockets, including back yoke and front access cargo pockets
- + Stretch waistband with Flexi-cuff tunnels

73346 Stealth Short | 10-1/2" inseam | Black 019, Stone 070, Ranger Green 186, Flint 258, Peacoat 787 | 28, 30, 31, 32, 33, 34, 35, 36-40 even waist |

BLACK 019	STONE 070	RANGER GREEN 186
FLINT 258	PEACOAT 787	

STRETCH PHONE POCKET





5.11 STRYKE® SHORT 11" INSEAM

Made with our revolutionary Flex-Tac® mechanical stretch ripstop fabric with a Teflon™ finish, the 5.11 Stryke™ Short features low-profile cargo pockets and an outstanding fit.

- + 6.8-oz., 65% polyester / 35% cotton Flex-Tac® mechanical stretch ripstop
- + Teflon™ finish for stain and soil resistance.
- + 12 pockets, cargo pockets feature internal organization
- + Fixed waistband

73327 5.11 Stryke Short | 11" inseam | Black 019, Khaki 055, Storm 092, Battle Brown 116, TDU Green 190, Tundra 192, Dark Navy 724 | 28, 30, 31, 32, 33, 34, 35, 36, 38-44 even waist |

BLACK 019	KHAKE 055	STORM 092
BATTLE BROWN 116	TDU GREEN 190	TUNDRA 192
DARK NAVY 724	 STRETCH  PHONE POCKET	





FAST-TAC URBAN SHORT

11" INSEAM



Sure, it's 90 degrees outside, but wearing less clothes doesn't have to mean being any less ready. Bring on the Fast-Tac™ Urban Short: The perfect CCW-ready, lightweight addition to your summer arsenal. Made from 4.7-oz. Fast-Tac 100% polyester ripstop fabric with a water-resistant finish and bartacking at key seams and stress points, this short is the perfect balance of comfort and durability. The welted front utility pocket is device ready, and go ahead and stuff a few extra items in the 5 pockets; they're built for it. 11" inseam. Imported.

- + 4.7-oz., 100% polyester Fast-Tac ripstop with water-resistant finish
- + 5 pockets, including a front phone pocket

73342 Men's Fast-Tac™ Urban Short | 11" Inseam | Black 019, Khaki 055, Dark Navy 724 | 28-44 even waist sizes |

BLACK 019

KHAKI 055

DARK NAVY 724

STRETCH PHONE POCKET



BASE SHORT

11" INSEAM



Hit the lake, the trail or the range without a second thought in the high-tech, easy-wear Base Short. Its four-way mechanical stretch 3.3-oz 100% polyester fabric with moisture wicking performance helps keep you cool and dry. A contoured waistband and a running gusset supports your range of motion. Imported.

- + 3.3-oz., 100% polyester mechanical stretch fabric with Enduro-Flex™ properties and a wicking finish
- + 7 pockets, including two back yoke utility pockets
- + Fixed waistband

73337 Men's Base Short | 11" Inseam | Black 019, Stone 070, Storm 092, Major Brown 367, Peacoat 787 | 30, 31, 32, 33, 34, 35, 36, 38, 40, 42, 44 waist sizes |

BLACK 019

STONE 070

STORM 092

MAJOR BROWN 367

PEACOCK 787

STRETCH PHONE POCKET



TACLITE® PRO SHORT



Lightweight and rugged Taclite fabric with self-adjusting waistband and eight pockets. Double layered seat with rear strap-and-slash pockets and our trademarked utility strap. Men's available in two inseam lengths. Imported.

- + 6.2-oz., 65% polyester / 35% cotton Taclite® ripstop fabric with a Teflon™ finish
- + 8 pockets including trademarked strap-and-slash seat pockets
- + Action waistband

73308 Taclite Short | 11" inseam | Charcoal 018, Black 019, Storm 092, Battle Brown 116, Coyote 120, TDU Khaki 162, TDU Green 190, Tundra 192, Dark Navy 724 | 28-44 even sizes |

73287 Taclite Short | 9-1/2" inseam | Black 019, Coyote 120, TDU Khaki 162, TDU Green 190, Tundra 192, Dark Navy 724 | 28-44 even sizes |

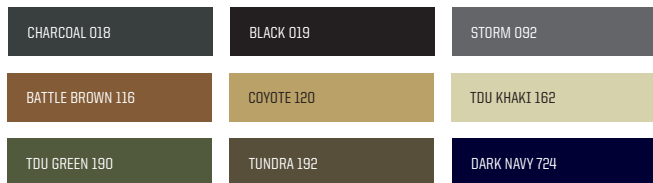

 PHONE POCKET



5.11 TACTICAL® SHORT

9" INSEAM



Hard-wearing and heavy duty, the 5.11 Tactical short is made of 100% cotton canvas and features a self-adjusting waistband, a double-layered seat, our trademarked utility strap and seven pockets.

- + 8.8 oz., 100% cotton canvas
- + 7 pockets including trademarked strap-and-slash seat pockets
- + Action waistband

73285 Tactical® Short | 9" inseam | Black 019, Khaki 055, OD Green 182, Fire Navy 720 | Men's 28-44 even sizes |





UTILITY PT SHORT 10-1/2" INSEAM

Made with 100% polyester jacquard mesh, 6.0-oz., wicking, and anti-odor finish with an elastic waistband. Imported.

43061 Men's Utility PT Short | 10-1/2" inseam | Black 019, Dark Navy 724 | S-3XL

BLACK 019

DARK NAVY 724



RANGE READY™ MERINO WOOL BRIEFS 9" INSEAM

The Range Ready Brief is constructed with an intelligent fabric blend of no-itch, super-soft, odor-resistant 4.1-oz. 81% Merino wool / 12% nylon / 7% elastane jersey. So, you stay warm and comfortable without compromising movement or agility. Imported.

40166 Range Ready™ Merino Wool Briefs | Black 019, Ranger Green 186, Royal Blue 693, Dark Navy 724 | S - 2XL |

BLACK 019

RANGER GREEN 186

ROYAL BLUE 693

DARK NAVY 724



PERFORMANCE BRIEFS 8.5" INSEAM

Available in a 6" or 9" inseam, 5.11's Performance Boxer Briefs feature a non-compressive fit in an 82% polyester / 18% elastane knit, with moisture-wicking and odor-control finish. Imported.

40155 6" Performance Boxer Brief | Black 019 | S-3XL

BLACK 019

**NEW****5.11 RECON® SHIELD TIGHT****COMPRESSION FIT**

Moisture-wicking and ventilated with gusseted mesh for comfort and a base layer for frigid climes. A sleek design will prevent chafing and attendant distraction during workout or movement in the field, and likewise means you don't need to worry about seam-stacking when using them as a base layer. Odor-control materials mean the folks working next you have less to worry about too.

+ Body fabric is 5-oz., 82% polyester / 18% elastane tricot with Enduro-Flex™ properties. 89% polyester / 11% elastane mesh

82406 5.11 RECON® Shield Tight | Ankle length, 27" inseam | Black 019, Ranger Green 186 | XS-2XL |

BLACK 019

RANGER GREEN 186

**RANGE READY™ MERINO WOOL TIGHT****COMPRESSION FIT**

Create a virtually impenetrable barrier between you and the coldest weather or the most wicked winds. The Range Ready Tight is constructed with an intelligent fabric blend of no-itch, super-soft, odor-resistant Merino wool, ultra-tough nylon and flexible elastane. So, you stay warm and comfortable without compromising movement or agility. Layer up, it might get nasty out there. Imported.

+ 4.1-oz., 81% Merino Wool / 12% nylon / 7% elastane jersey knit with moisture wicking and odor-control

40165 Range Ready™ Merino Wool Tight | Black 019 | S - 2XL |

BLACK 019

MEN'S TOPS

From hard wearing work shirts, to casual shirts with hidden features, we've got the solution you're after.

Hawthorn Shirt, p 44





HAWTHORN LONG-SLEEVE SHIRT REGULAR FIT

It may look like a contemporary button down, but let's be clear: the Hawthorn L/S Shirt is a 5.11 button-up, and that comes with responsibility. The Hawthorn delivers a tactical punch with a RAPIDDraw™ placket for quick access to your CCW, dual chest pockets, and a hidden zippered pocket at the left chest. Factor in 100% cotton twill and a casual fit, and your comfort level will be as high as your confidence. Imported.

- + 5.4-oz., 100% cotton twill with a peached, rinsed wash
- + Patch pockets on left and right chest, zippered pocket on left chest, pen pocket on left sleeve

72513 Hawthorn Long-Sleeve Shirt | Khaki 055, Volcanic 098, Ranger Green 186, Tidal 631 | XS-2XL |

KHAKI 055

VOLCANIC 098

RANGER GREEN 186

TIDAL 631

 RAPIDDRAW



NEW

MARKSMAN LONG-SLEEVE SHIRT

REGULAR FIT

Regardless of your individual motivation, the Marksman Long Sleeve button-up shirt was built to protect you from sun exposure. It has a UPF rating of 50+, is moisture wicking, features mesh fabric underarm gussets, and has Vent-Tac™ properties for ventilation. Dual chest pockets with flaps, roll-up sleeves and a sleeve pen pocket add to its versatility.

- + 2.6-oz., 100% polyester aero tech poplin with moisture wicking
- + UPF rating of 50+
- + Patch pockets on left and right chest, pen pocket on left sleeve

72521 Marksman Long Sleeve Shirt | Sand 038, Volcanic 098, Ranger Green 186, Patina 900 | XS-2XL |

SAND 038	VOLCANIC 098	RANGER GREEN 186
PATINA 900		



ALPHA FLEX SHIRTS

FITTED

Since when is a button-down so flexible and tough? Since now. The Alpha Flex Long Sleeve Shirt would look great in a boardroom, but that would be a waste of advanced garment technology. From the stretch collar to the poly/cotton doobby stretch fabric, this shirt bends and flexes right along with you, whether you're tracking a suspect or working a long shift on event security. It's even got impact-resistant buttons if things get a little intense. Add an Alpha Flex or two into your Mission Ready™ covert wardrobe and be dressed for some serious action. Imported.

- + 4.4-oz., 56% polyester / 44% cotton Flex-Tac® fabric
- + Teflon™ finish for stain and soil resistance
- + Stretch collar

72491 Alpha Flex Long Sleeve Shirt | Blueblood Check 429, Volcanic Check 431, Ranger Green Check 432 | XS - 2XL |

BLUEBLOOD CHECK 429	VOLCANIC CHECK 431	RANGER GREEN CHECK 432
---------------------	--------------------	------------------------



5.11 STRYKE® SHIRTS REGULAR FIT

Remember what it felt like the first time you pulled a trigger? How'd you like to feel that rush every time you open your closet? The Stryke Shirt is built with Flex-Tac® mechanical stretch fabric, treated with stain- and soil-resistant Teflon™, has a rain-repellent finish, and it comes with 5.11's patented Ready Pockets™, pen pockets, and sleeve roll-up tabs. Imported.

- + 4.8-oz. 62% polyester / 38% cotton Flex-Tac® mechanical stretch ripstop with Teflon™ finish
- + Ready Pocket™ and patch pocket on left and right chest, pen pocket on left sleeve

BLACK 019

KHAKI 055

STORM 092

RANGER GREEN 186

TDU GREEN 190

TUNDRA 192

DARK NAVY 724

 READY POCKET™

71354 Short-Sleeve 5.11 Stryke® Shirt | Black 019, Khaki 055, Storm 092, TDU Green 190, Tundra 192, Dark Navy 724 | XS-3XL

72399 Long-Sleeve 5.11 Stryke® Shirt | Black 019, Khaki 055, Storm 092, Ranger Green 186, TDU Green 190, Tundra 192, Dark Navy 724 | XS-3XL

72399T Tall Long-Sleeve 5.11 Stryke® Shirt | Black 019, Khaki 055, Storm 092, Ranger Green 186, TDU Green 190, Tundra 192, Dark Navy 724 | L-5XL Tall |

50541 5.11 Stryke® Epaulette Kit | Black 019, Khaki 055, TDU Green 190, Dark Navy 724 |



TACLITE PRO® SHIRTS

CLASSIC FIT

The Taclite Pro Shirt is a tactical wardrobe staple, alongside shoes, pants, and mean-looking sunglasses. This shirt is rugged, lightweight, breathable, finished with Teflon™, and made of poly/cotton ripstop fabric. It has Ready Pockets, pen pockets, and adjustable cuffs. Imported.

- + 4.2-oz., 65% polyester / 35% cotton Taclite® ripstop with Teflon™
- + Ready Pocket™ on left and right chest, pen pocket on left sleeve

71175 Short-Sleeve Taclite Pro Shirt | White 010, Charcoal 018, Black 019, TDU Khaki 162, TDU Green 190, Dark Navy 724 | S-3XL

71175T Tall Short-Sleeve Taclite Pro Shirt | Charcoal 018, Black 019, TDU Khaki 162, Dark Navy 724 | L-5XL |

72175 Long-Sleeve Taclite Pro Shirt | White 010, Charcoal 018, Black 019, Storm 092, Battle Brown 116, Coyote 120, TDU Khaki 162, Ranger Green 186, TDU Green 190, Tundra 192, Dark Navy 724 | S-3XL

72175T Tall Long-Sleeve Taclite Pro Shirt | Charcoal 018, Black 019, TDU Khaki 162, Ranger Green 186, Dark Navy 724 | L-5XL |

62070 Women's Taclite Pro Long-Sleeve Shirt | Black 019, TDU Khaki 162, TDU Green 190, Dark Navy 724 | XS-XL |

WHITE 010	CHARCOAL 018	BLACK 019	STORM 092
BATTLE BRN 116	COYOTE 120	TDU KHAKI 162	RNGR GRN 186
TDU GREEN 190	TUNDRA 192	DARK NAVY 724	READY POCKET™



5.11 TACTICAL® SHIRTS

CLASSIC FIT

Every once in a while, something great comes along that changes the way people think. The 5.11 Tactical Shirt—another time-tested industry standard—features triple-needle stitching, strategic bartacking, and 100% cotton canvas for enhanced durability. A cape-back with mesh lining guarantees comfort and breathability, and our patented hidden Ready Pockets, pen pockets, and adjustable cuffs provide superior functionality. There's nothing to add. It's the original tactical shirt. Imported.

- + 5.7-oz., 100% cotton canvas
- + Ready Pocket™ on left and right chest, pen pocket on left sleeve

71152 Short-Sleeve 5.11 Tactical Shirt | Black 019, Grey 029, Khaki 055, Coyote 120, OD Green 182, Fire Navy 720, Sage 833 | XS-3XL

72157 Long-Sleeve 5.11 Tactical Shirt | Black 019, Grey 029, Khaki 055, Coyote 120, OD Green 182, Fire Navy 720, Sage 833 | XS-3XL

BLACK 019	GREY 029	KHAKI 055
COYOTE 120	OD GREEN 182	FIRE NAVY 720
SAGE 833	READY POCKET™	



FAST-TAC™ SHIRTS

REGULAR FIT



With a Fast-Tac™ shirt on your back, you'll stay cool, calm and ready to handle just about anything. Made with our 100% polyester Fast-Tac™ 4.7-oz ripstop fabric with a water-resistant finish, plus double- and triple-needle stitching it's lighter and stronger than ever. Front patch pockets and 5.11's patented pen pocket on the left sleeve give you smart storage options and are even embroidery friendly. Worn tucked in or out, this shirt radiates understated style and big-time confidence. Available in men's and women's. Includes badge tab and epaulette kit. Imported

- + 4.7-oz., 100% polyester Fast-Tac™ ripstop with water resistant finish
- + Patch pocket on left and right chest, pen pocket on left sleeve

CHARCOAL 018

BLACK 019

KHAKI 055

DARK NAVY 724

UNIFORM WHITE 992

72479 Men's Fast-Tac™ Long-Sleeve Shirt | Charcoal 018, Black 019, Khaki 055, Dark Navy 724, Uniform White 992 | S-3XL (3XL 72479T L-5XL Tall)

62388 Women's Fast-Tac™ Long-Sleeve Shirt | Charcoal 018, Black 019, Khaki 055, Dark Navy 724, Uniform White 992 | XS-XL |

71373 Men's Fast-Tac™ Short-Sleeve Shirt | Charcoal 018, Black 019, Khaki 055, Dark Navy 724, Uniform White 992 | S-3XL (3XL 71373T L-5XL Tall)

61314 Women's Fast-Tac™ Short-Sleeve Shirt | Charcoal 018, Black 019, Khaki 055, Dark Navy 724, Uniform White 992 | XS-XL |



FREEDOM FLEX™ LONG-SLEEVE SHIRT REGULAR FIT

Built for any task, anywhere, this shirt delivers ultimate comfort with mechanical stretch fabric, wicking finish and perforated sections throughout. RAPIDDraw™ placket and chest pockets complete its tactical purpose. Imported.

- + 3.3-oz., 100% polyester mechanical stretch fabric with Enduro-Flex™ properties and a moisture wicking finish
- + Front chest pockets and pen pocket on left sleeve

72417 Freedom Flex™ Long-Sleeve Shirt | Black 019, Storm 092, Ranger Green 186, Peacoat 787, Atlas 793 | S-2XL |

BLACK 019	STORM 092	RANGER GREEN 186
PEACOCK 787	ATLAS 793	RAPIDDRAW



HI-VIS PERFORMANCE SHIRT CLASSIC FIT

As if the ANSI chromaticity rating doesn't say "safety first," the Hi-Vis Orange color gets the point across loud and clear. The Hi-Vis Performance long sleeve shirt is built to protect you from the outside in, from the color, to the water-resistant, Fast-Tac® ripstop fabric infused with a UPF of 50-plus. This shirt is also document-ready and has sleeve tabs for easy roll-up when you're really getting into your work. When are you not? Imported.

- + 4.7-oz, 100% polyester, Fast-Tac® ripstop with water resistant finish
- + Ready Pocket™ and patch pocket on left and right chest, pen pocket on left sleeve

72516 Hi-Vis Performance Long-Sleeve Shirt | Hi-Vis Orange 405 | S-3XL, L-5XL Tall (72516T)

HI-VIS ORANGE 405	<input checked="" type="checkbox"/> READY POCKET™
-------------------	---



Foldable Hi-Vis Cap (p 156)

**NEW****CONTENDER LONG-SLEEVE SHIRT****FITTED**

The Contender quarter zip is in many ways like a combat shirt built for the gym or athletic endeavors. Moisture-wicking, odor-fighting Enduro-Flex™ make it a supremely comfortable garment that is easy to move in, and a zip secured pocket on the left sleeve with tether cord provides “dummy cord” style retention during rigorous activity.

72512 Contender Long Sleeve Shirt | Black 019 | XS-2XL |

BLACK 019

- + 4.7-oz., 87% polyester / 13% elastane weave with Enduro-Flex™ properties, moisture wicking and odor-control finish
- + Zippered pocket on left sleeve with internal tether cord



RAPID OPS SHIRT FITTED

Engineered with input from military and law enforcement personnel, the Rapid Ops is the ideal tactical base layer with four-way stretch fabric, moisture wicking and quick drying performance. 4.7-oz. poly/elasane fabric. Imported.

- + 4.7-oz., four-way stretch 87% polyester / 13% elastane with Enduro-Flex[™] properties, moisture wicking and odor-control finish
- + Zippered pocket at each bicep

72199 Rapid Ops Shirt | Black 019, TDU Green 190, Dark Navy 724 | XS-3XL



RAPID HALF-ZIP FITTED

The Rapid Half-Zip isn't just a shirt, it's an attitude. Inspired by some of our most popular designs, it features a mix of performance fabrics for enhanced layering and tactical utility. The body utilizes a 92% polyester/8% spandex fabric that wicks away moisture, while the sleeves, shoulders, and collar consist of polyester/spandex fabric with two-way stretch, quick-dry properties, and additional moisture wicking. Imported.

- + Body fabric is 7.1-oz., 92% polyester / 8% elastane mélange jersey with odor-control and wicking finish; sleeves/collar fabric is 6.4-oz. 90% polyester / 10% elastane bi-stretch double weave
- + Zippered pocket at left bicep

72444 Rapid Half Zip | Charcoal/Kryptek Typhon 018 | XS-2XL |

72415 Rapid Half-Zip | TDU Green 190, True Black 264, Dark Navy 724 | S-2XL |

72415G7 GE07 Rapid Half-Zip | Night 357, Terrain 865 | S-2XL |

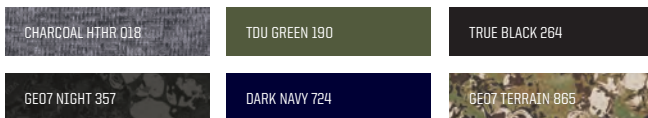

**NEW****CARSON SHORT-SLEEVE SHIRT**

REGULAR FIT

The Carson Short-Sleeve is a CCW classic (or will be). Clean lines and a classic casual snap-front style present a relaxed look while reducing the print of your sidearm and standing by for any eventuality...in no small part thanks to the RAPIDDraw™ placket it has aboard. Happily, Carson comes in a sufficient variety of solid colors and plaids to keep you dressed every day of the week.

- + 3.1-oz., 60% cotton / 40% polyester poplin, rinse wash
- + Left chest patch pocket

71201 Carson Short-Sleeve Shirt | Patina Heather 394, Volcanic Heather 395, Ranger Green Heather 396, Fig Heather 573 | XS-2XL |

71394 Carson Plaid Short-Sleeve Shirt | Patina Plaid 415, Blueblood Plaid 416, Stone Plaid 417 | XS-2XL |

PATINA HEATHER 394

VOLCANIC HEATHER 395

RNGR GRN HEATHER 396

PATINA PLAID 415

BLUEBLOOD PLAID 416

STONE PLAID 417

FIG HEATHER 573





NEW
VENTURE SHORT-SLEEVE SHIRT **REGULAR FIT**

Validate your wardrobe before you venture forth - can it handle whatever you might encounter? Does it let you move without discomfort? You'll be answering in the affirmative if you're wearing this stylish short-sleeve collared shirt. It's made with a 5.3 oz. 55/45 blend of Pima cotton/ polyester fabric with an enzyme finish and features side seam vents for air circulation. A pen guide at the chest pocket and another on the left sleeve provide utility, and the button front placket give the shirt a relaxed but semi-professional air.

- + 5.3-oz., 55% pima cotton / 45% polyester jersey knit with an enzyme finish
- + Left chest patch pocket and pen pocket on wearers left sleeve

41233 Venture Short-Sleeve Shirt | Black 019, Blueblood 622 | XS-2XL |

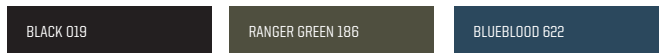

NEW
TANGO SHORT-SLEEVE SHIRT **REGULAR FIT**



Conspicuous. Perceptible. Prominent. None of these are words you want associated with a weapon carried casually or off duty. The choice of a good cover garment is paramount, which is why we've added the Tango Short-Sleeve Shirt to our lineup. The Vent-Tac™ fabric falls naturally and allows airflow, while the colors of the shirt themselves help reduce printing. There's also a RAPIDraw™ placket gives the wearer fighting functionality. Note chest pocket with flap and pen guide and branded metal case buttons and snaps.

- + 2.3-oz., 76% polyester / 24% nylon with Vent-Tac™ properties and a moisture-wicking finish
- + Left chest pocket with button flap closure

71397 Tango Short-Sleeve Shirt | Volcanic 098, Ranger Green 186, Patina 900 | XS-2XL |





FREEDOM FLEX™ SHORT-SLEEVE SHIRT REGULAR FIT

Built for any task, anywhere, this shirt delivers ultimate comfort with mechanical stretch fabric, wicking finish and perforated sections throughout. RAPIDDraw™ placket and chest pockets complete its tactical purpose. Imported.

- + 3.3-oz., 100% polyester mechanical stretch fabric with Enduro-Flex™ properties and a moisture wicking finish
- + Front chest pockets and pen pocket on left sleeve

71340 Freedom Flex™ Short-Sleeve Shirt | Black 019, Storm 092, Ranger Green 186, Mahogany 447, Peacoat 787, Dusty Sage 820 | S-2XL |

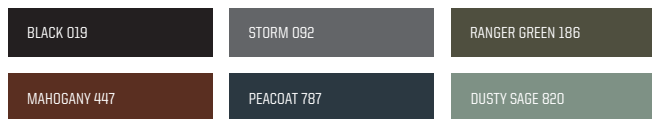

FLEX-TAC TWILL SHORT-SLEEVE SHIRT REGULAR FIT

You want a shirt that stands up to the day in front of you, and even more? You need our Flex-Tac® Twill shirt with Teflon™ finish. It's unquestionably durable, but also remarkably comfortable. Our Flex-Tac® Twill is an ideal blend of cotton and polyester that feels great to the touch. The perforated side panels are made of 5.11's signature woven Freedom Flex fabric with wicking technology to keep you cool and dry. The casual look of a regular fit and dual chest patch pockets add to the finish and style of this tactical shirt. Imported.

- + Main fabric is 5.8-oz., 73% poly / 37% cotton Flex-Tac® twill with Teflon™ finish and rinse wash. Vent-Tac™ inserts are 3.3-oz., 100% poly
- + Teflon™ finish for stain and soil resistance

71390 Flex-Tac® Twill S/S Shirt | Black 019, Lunar 082, Major Brown 367, Mahogany 447, Peacoat 787 | XS-2XL |

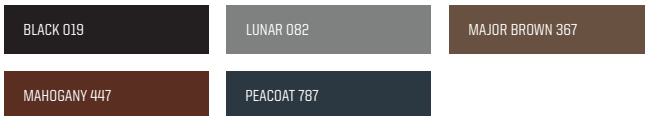



PARAMOUNT POLO REGULAR FIT

Don't be fooled by the Paramount Polo's feather-light, 4.5-oz 100% polyester fabric. Sure, it's made for ultimate comfort, we'll give you that. But its snag-resistant knit fabric, moisture-wicking capabilities and anti-odor performance come together to give you a true performance edge. This polo offers high-end professional construction in a shirt with a casual look and feel. You're sure to find the pen pocket at the left sleeve and underarm gussets for freedom of movement particularly useful, especially on days that start off at the office and end on the range. Imported.

- + 4.5-oz., 100% polyester jersey knit with Enduro-Flex™ properties plus moisture wicking and odor-control
- + Pen pocket on left sleeve

41221 Paramount Polo | Heather Grey 016, Black 019, Charcoal Heather 035, Flint 258, Blue Blood 622, Mystic Heather 635 | XS-2XL |

HEATHER GREY 016	BLACK 019	CHARCOAL HTHR 035
FLINT 258	BLUEBLOOD 622	MYSTIC HTHR 635



PROFESSIONAL POLOS CLASSIC FIT

5.11's Professional Polo is made of durable, soft 100% cotton pique knit that's treated to retain color. The Professional Polo features a stay-flat, no-roll collar, pen pockets on the sleeve, and shrink-, wrinkle-, and fade-resistance. Imported.

- + 6.7-oz., 100% cotton pique knit
- + Pen pocket on left sleeve

WHITE 010	HEATHER GREY 016	BLACK 019
SILVER TAN 160	RANGE RED 477	ACADEMY BLUE 692
MEDIUM BLUE 696	DARK NAVY 724	L.E. GREEN 860

41060 Men's Short-Sleeve Professional Polo | White 010, Heather Grey 016, Black 019, Silver Tan 160, Range Red 477, Academy Blue 692, Fire Med Blue 696, Dark Navy 724, L.E. Green 860 | XS-3XL

41060T Tall Men's Short-Sleeve Professional Polo | Heather Grey 016, Silver Tan 160, Fire Med Blue 696, Dark Navy 724 | L-5XL Tall |

42056 Men's Long-Sleeve Professional Polo | White 010, Heather Grey 016, Black 019, Silver Tan 160, Range Red 477, Academy Blue 692, Dark Navy 724, L.E. Green 860 | XS-3XL

42056T Tall Men's Long-Sleeve Professional Polo | Heather Grey 016, Black 019, Silver Tan 160, Dark Navy 724 | L-5XL Tall |

61166 Women's Short-Sleeve Professional Polo | White 010, Black 019, Silver Tan 160, Dark Navy 724 | S-XL |



TACTICAL POLOS CLASSIC FIT

Made of 100% cotton jersey knit and built to be shrink-, wrinkle-, and fade-resistant, 5.11's Tactical Polo is a clean, professional shirt for any situation. It features our stay-flat, no-roll collar, pen pockets on the sleeve, and mic-clips at the shoulders and sternum. The Tactical Polo is ready for custom embroidery or printing from the 5.11 Custom Shop. UPF 50. Imported.

- + 6-oz., 100% cotton jersey knit fabric
- + Mic loops at shoulders, chest plus pen pocket on left sleeve

71182 Men's Short-Sleeve Tactical Polo | White 010, Heather Grey 016, Black 019, Silver Tan 160, Dark Navy 724 | S-3XL

72360 Men's Long-Sleeve Tactical Polo | Black 019, Silver Tan 160, Dark Navy 724 | S-3XL

61164 Women's Short-Sleeve Tactical Polo | White 010, Heather Grey 016, Black 019, Silver Tan 160 | S-XL |

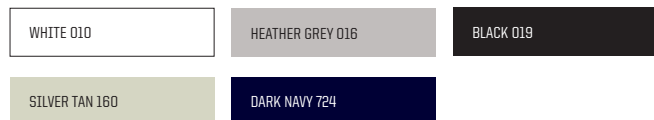

HELIOS POLOS CLASSIC FIT



Built from 4.5-oz. snag-resistant knit fabric, the Helios Polo is moisture-wicking, quick-drying, and anti-odor; all of which means you'll stay nice and cool when the weather gets hot and sticky. With underarm gussets to provide full range of movement, front mic-clip pockets, shoulder mic loops, and a sunglasses loop, you'll be ready for anything life throws at you. Imported.

- + 4.5-oz., 100% polyester jersey knit with Enduro-Flex™ properties plus moisture wicking and odor-control
- + Mic clip pockets at each shoulder, pen pocket on left sleeve

41192 Helios Polo | Heather Grey 016, Charcoal 018, Black 019, Silver Tan 160, Academy Blue 692, Fire Med Blue 696, Dark Navy 724 | S-3XL

61305 Womens Helios Polo | Charcoal 018, Black 019, Silver Tan 160, Dark Navy 724 | S-XL |





PERFORMANCE POLOS

CLASSIC FIT

Made of jersey-knit 100% polyester fabric, the Performance Polo is wrinkle- and shrink-resistant, snag-resistant, anti-odor, and has a stay-flat, no-roll collar. You could wad this thing up, stuff it in a cannon, and fire it down the range, and it would still look shiny and new. The Performance Polo also features collarbone and front mic-clip pockets, embellishment friendly pen pocket, and it wicks moisture. Imported.

- + 6.7-oz., 100% polyester jersey knit with Enduro-Flex™ properties plus moisture wicking and odor-control
- + Mic loops at shoulders, chest plus pen pocket on left sleeve

WHITE 010

CHARCOAL 018

BLACK 019

SILVER TAN 160

TDU GREEN 190

RANGE RED 477

DARK NAVY 724

L.E. GREEN 860

71049 Men's Short-Sleeve Performance Polo | White 010, Charcoal 018, Black 019, Silver Tan 160, TDU Green 190, Range Red 477, Dark Navy 724, LE Green 860 | XS-3XL (3XL)

71049T Men's Short-Sleeve Performance Polo | Black 019, Silver Tan 160, Dark Navy 724 | L-5XL |

72049 Men's Long-Sleeve Performance Polo | Black 019, Silver Tan 160, Dark Navy 724, LE Green 860 | S-3XL (3XL)

72049T Men's Long-Sleeve Performance Polo | Black 019, Silver Tan 160, Dark Navy 724 | L-5XL |

61165 Women's Short-Sleeve Performance Polo | White 010, Black 019, Silver Tan 160, Range Red 477, Dark Navy 724 | S-XL |



UTILITY POLOS

CLASSIC FIT

5.11®'s Utility Polo is shrink-, wrinkle-, and fade-resistant. It features a stay-flat, no-roll collar, pen pockets on the sleeve, and a 60% cotton/40% polyester pique blend for superior comfort and flexibility. You can't build a better basic polo shirt, and you can't stock your wardrobe with a better value. It's a win-win. UPF 50. Imported.

- + 6.3.oz., 60% cotton / 40% polyester pique knit
- + Pen pocket on left sleeve

WHITE 010	HEATHER GREY 016	BLACK 019
SILVER TAN 160	RANGE RED 477	ACADEMY BLUE 692
MEDIUM BLUE 696	DARK NAVY 724	L.E. GREEN 860

41180 Men's Short-Sleeve Utility Polo | White 010, Heather Grey 016, Black 019, Silver Tan 160, Range Red 477, Academy Blue 692, Dark Navy 724, LE Green 860 | XS-3XL (3XL)

41180T Men's Short-Sleeve Utility Polo | White 010, Heather Grey 016, Black 019, Silver Tan 160, Range Red 477, Academy Blue 692, Dark Navy 724, LE Green 860 | L-5XL Tall |

72057 Long-Sleeve Utility Polo | White 010, Heather Grey 016, Black 019, Silver Tan 160, Range Red 477, Academy Blue 692, Dark Navy 724, LE Green 860 | XS-3XL (3XL)

61173 Women's Short-Sleeve Utility Polo | Heather Grey 016, Black 019, Silver Tan 160, Dark Navy 724 | S-XL |



REFLEX POLO REGULAR FIT

For covert ops, all-out undercover duty or weekends on-call, the Reflex Polo is a versatile, mission ready essential. Our Freedom Flex fabric provides optimal comfort indoors or out, while side vents and a wicking and anti-odor finish help keep you cool under pressure. Tactically, this polo is set up for all your gear, with mic pockets, document pockets and a pen pocket all within easy reach. The 100% polyester feels remarkably light, especially in the ease of a regular fit cut. Imported.

- + Body fabric is 3.3-oz., 100% polyester mechanical stretch woven with Enduro-Flex™ properties plus moisture wicking and odor-control; contrast fabric is 4.5-oz., 100% polyester jersey knit with Enduro-Flex™ properties plus moisture wicking and odor-control
- + Chest pockets and pen pocket on left sleeve

41225 Reflex Polo | Black 019, Silver Tan 160, Dark Navy 724 | XS – 2XL |

BLACK 019

SILVER TAN 160

DARK NAVY 724



RAPID PERFORMANCE POLO CLASSIC FIT

Bringing operator-oriented performance to everyday, easy wear apparel, the Rapid Performance Polo features woven polyester sleeves and a polyester/spandex jersey body for outstanding colorfastness and comfort. Raglan shoulder construction and gusseted sleeves offer a full range of motion and comfortable wear. Imported.

- + 5.3-oz., jersey knit 87% polyester / 13% elastane with moisture wicking and odor-control
- + Mic clip pockets at each shoulder, pen pocket on left sleeve

41018 Rapid Performance Polo | Black 019, Silver Tan 160, TDU Green 190, Fire Medium Blue 696, Dark Navy 724 | UPF 50 | XS-3XL (3XL)



PINNACLE POLO REGULAR FIT



Constructed from snag-resistant, anti-odor, lightweight, 100% polyester fabric, the Pinnacle Polo features a sunglass loop at the placket base, a patented pen pocket on the sleeve, and moisture-wicking breathability. The Pinnacle Polo is also handsome and fade-resistant. Imported.

- + 4.5-oz., 100% polyester jersey with Enduro-Flex™ properties plus moisture-wicking and odor-control
- + Sunglass loop at front placket and pen pocket on left sleeve

71036 Pinnacle Polo | Charcoal 018, Black 019, Fatigue 200, Range Red 477, Nautical 677, Dark Navy 724 | S-2XL |

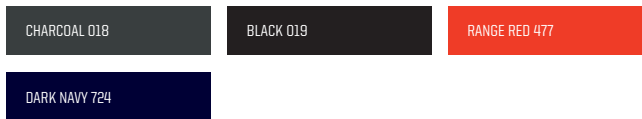



RANGE READY™ MERINO WOOL TOPS FITTED

Throw on the premium “beast layer” and dial up the comfort and warmth, even on the coldest morning runs. A blend of no-itch, extra-soft, odor-resistant Merino wool, super-tough nylon and flexible elastane, it fits your body like a second skin. Imported.

+ 4.1-oz., 81% Merino wool / 12% nylon / 7% elastane jersey knit

40164 Range Ready™ Merino Wool Long Sleeve | Black 019, Ranger Green 186, Dark Navy 724 | XS – 2XL |

40163 Range Ready™ Merino Wool Short Sleeve | Black 019, Ranger Green 186, Royal Blue 693, Dark Navy 724 | XS – 2XL |

BLACK 019

RANGER GREEN 186

ROYAL BLUE 693

DARK NAVY 724



RANGE READY™ TOPS FITTED

Whether you're shooting targets or baskets, the Range Ready™ top helps keep you comfortable and focused. The lightweight, 100% polyester fabric features wicking and anti-odor properties; while flatlock seams give this shirt a clean looking finish. After all, it's better to have people see you go all out than to smell your efforts. Grab a Range Ready™ shirt in a few colors to pair with workout shorts, jeans or khakis for a sharp, casual look. Imported.

+ 4.5-oz., 100% polyester jersey knit with Enduro-Flex™ properties plus moisture wicking and odor-control

40161 Range Ready™ Long Sleeve | Black 019, Storm 092, Moss 191, Dark Navy 724 | XS – 2XL |

40168 Range Ready™ Short Sleeve | Black 019, Storm 092, Moss 191, Dark Navy 724 | XS – 2XL |

BLACK 019

STORM 092

MOSS 191

DARK NAVY 724



**NEW****CAMS SHORT-SLEEVE BASE LAYER****COMPRESSION FIT**

The CAMS base layer tee is an outstanding concealed carry alternative to IWB or appendix-carry. It's built with a tee style upper body using a 4.1 oz. 60% cotton/40% polyester jersey above a compression-fit lower body. Both are moisture wicking, but the top looks like a typical, everyday t-shirt - perfect to wear beneath a collared shirt or similar garment.

A body pocket on either side for firearm and/or accessories provides a quick, comfortable, extremely low visibility solution for a firearm in any sort of casual or off-duty environment. The integral odor-control fabric and 4mm ultralite Ortholite® padding will keep you comfortable while fighting the funk of sustained activity.

- + Upper body is 4.1-oz., 60% cotton / 40% polyester jersey with moisture wicking; lower body is 5.1-oz., 86% poly / 14% elastane jersey with moisture wicking and odor-control
- + Pocket features 4mm Ortholite™ padding and 8.8-oz., 92% polyester / 8% elastane spacer mesh with moisture wicking and odor-control

41222 CAMS Short Sleeve Base Layer | White 010, Black 019 | XS-2XL |

WHITE 010

BLACK 019

**UTILITY PT SHIRT****CLASSIC FIT**

The PT Shirt features underarm gussets and raglan shoulders for full range of motion. Built with an extended length to stay tucked in when worn as a base layer. Imported.

- + 4.3-oz., 100% polyester jersey fabric with moisture wicking and odor-control

41017 Men's Utility PT Shirt | Black 019, TDU Green 190, Dark Navy 724 | S-3XL

BLACK 019

TDU GREEN 190

DARK NAVY 724



NEW

5.11 RECON® CHARGE SHORT-SLEEVE TOP REGULAR FIT

At the gym, on a run, or hitting the range? Push yourself as hard as you want. The lightweight, ultra-breathable 5.11 RECON Charge will stand up to whatever extremes you put it - and you - through as you train. Mesh on the sleeves and across a back panel will let you cool down quickly while its high performance, odor fighting fabrics wick moisture away while battling sweat and funk. This is no typical tee. The Charge is a rigorous activity training garment.

- + Body fabric is 4.1-oz., 60% cotton / 40% polyester jersey with moisture wicking; mesh contrast Vent-Tac™ fabric is 92% polyester / 8% elastane with moisture wicking and odor-control.

82123 5.11 RECON® Charge Short-Sleeve Top | Black 019, Ranger Green 186, Blueblood 622 | XS-2XL |



NEW

PERFORMANCE UTILI-T (2 PACK) FITTED

The Performance Utili-T is an ultra-comfortable, fitted tee with Enduro-Flex™ properties plus moisture wicking and odor-control.

- + 4.5-oz., 100% polyester jersey with Enduro-Flex™ properties, moisture wicking and odor-control

40175 Performance Utili-T Long Sleeve Two-Pack | White 010, Black 019, Dark Navy 724 | S-3XL |

40174 Performance Utili-T Short Sleeve Two-Pack | White 010, Black 019, ACU Tan 165, Dark Navy 724 | S-3XL |

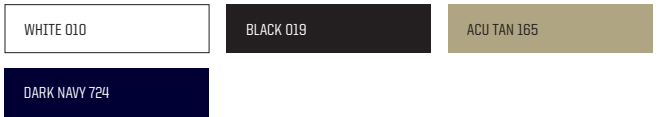



UTILI-T FITTED

Lightweight, moisture-wicking, 100% cotton, and it's cut extra long so that it stays tucked in. Imported.

+ 4.7-oz., 100% cotton with moisture wicking

40016 3 Pack, Short-Sleeve Utili-T | White 010, Black 019, ACU Tan 165, Dark Navy 724 | S-3XL

40046 2 Pack, Long-Sleeve Utili-T | Dark Navy 724 | S-3XL

WHITE 010

BLACK 019

ACU TAN 165

DARK NAVY 724



STATION WEAR TEES FITTED

With 100% medium-weight cotton jersey knit, the Station T delivers superior performance at an excellent price. Durable elastane ribbed crew neck. Imported.

+ 6-oz., 100% cotton jersey knit

40050 Station Wear Short-Sleeve T | Heather Grey 016, Range Red 477, Fire Navy 720 | S-3XL

40052 Station Wear Long-Sleeve T | Heather Grey 016, Fire Navy 720 | S-3XL

HEATHER GREY 016

RANGE RED 477

FIRE NAVY 720



PROFESSIONAL TEES CLASSIC FIT

Built with 100% ringspun cotton jersey knit, the Professional T is shrink-, wrinkle-, and fade-resistant. Available in standard crew, pocketed crew and long-sleeve crew styles. UPF 50. Imported.

+ 5.9-oz., 100% cotton jersey knit with shrink-, wrinkle-, and fade-resistance performance

FIRE NAVY 720

71307 Professional Pocketed T | Fire Navy 720 | XS-3XL

71309 Professional Short-Sleeve T | Fire Navy 720 | XS-3XL

72318 Professional Long-Sleeve T | Fire Navy 720 | XS-3XL



5.11® TIGHT FIT CREW COMPRESSION FIT

Featuring flatlock seams (help prevent chafing), plus odor-controlling, moisture-wicking, fast-drying properties, these shirts are built for performance and support with a tight fit and long cut. Imported.

+ 5-oz., 82% polyester / 18% elastane jersey with moisture wicking and odor-control

| **40005 Tight-Fit Short-Sleeve** | Black 019 | S-2XL |

BLACK 019



5.11® LOOSE FIT CREW CLASSIC FIT

Featuring flatlock seams (help prevent chafing), plus odor-controlling, moisture-wicking, fast-drying properties, these shirts are built for movement with a loose, comfortable fit. Imported.

+ 4-oz., 100% polyester with moisture wicking and odor-control

| **40007 Loose-Fit Crew** | White 010, Black 019 | S-3XL |

WHITE 010

BLACK 019

MEN'S OUTERWEAR

Always Be Ready for whatever conditions come your way with a full range of duty and casual outerwear from 5.11.

Sabre Jacket 2.0 (p 79) and
Defender-Flex Jeans (p 16-17)





3-IN-1 PARKA™

CLASSIC FIT



The 3-in-1 Parka is another versatile, all-weather solution. With a breathable, waterproof outer-shell and removable fleece liner that doubles as a standalone tactical jacket, you'll be in great shape in spite of the elements. The outer-shell features mic loops, a detachable hood, Ready Pockets, hidden ID panels, and side zippers for rapid firearm access and enhanced ventilation. The fleece liner offers mic loops, 4 tactical pockets, and side zippers. Outer shell and fleece liner are TacTec™-compatible. Imported.

- + Parka: 5.2-oz., 100% nylon plain weave, 10K/6K, 2L, DWR finish
- + Fleece: 10.3-oz., 100% polyester anti-pilling fleece with 3.8-oz., 100% nylon overlays, DWR finish

48001 3-in-1 Parka | Black 019, Range Red 477, Dark Navy 724 | XS-4XL

48001TAA TAA Compliant 3 in 1 Parka | Black 019, Dark Navy 724 | XS-3XL |

BLACK 019

RANGE RED 477

DARK NAVY 724

READY POCKET™ ID PANELS



AGGRESSOR PARKA

CLASSIC FIT



The Aggressor Parka is a versatile, all-weather solution with a low-vis appearance. With a breathable, waterproof outer-shell and removable fleece liner that doubles as a standalone jacket, you'll be ready for the elements. The outer-shell features a detachable hood, Ready Pockets, and side zippers for access and ventilation. The fleece liner offers mic loops, 4 tactical pockets, and side zippers. Outer shell and fleece liner are TacTec™-compatible. Imported.

- + Parka: 5.2-oz., 100% nylon plain weave, 10K/6K, 2L, DWR finish
- + Fleece: 10.3-oz., 100% polyester anti-pilling fleece with 3.8-oz., 100% nylon overlays, DWR finish

48032 Aggressor Parka™ | Aggressor Parka is same profile as 48001 but does not include mic loops on shoulders | Coyote 120, Tundra 192 | XS-4XL

COYOTE 120

TUNDRA 192

READY POCKET™ ID PANELS



FLEECE JACKET
 INCLUDED

BRISTOL PARKA CLASSIC FIT



5.11®'s Bristol Parka has a 100% nylon outer-shell that's breathable, waterproof, and bloodborne pathogen-resistant*. The outer shell also features mic loops, hidden utility pockets, a hidden badge tab, hidden ID panels, and our Quixip® System for rapid access to a concealed firearm. The removable softshell jacket is 100% polyester bonded softshell, and offers hidden utility pocket and hand-warmer pockets. Bring on the weather. Imported.

- + Parka: 5-oz., 100% nylon plain weave, 10K/6K, 2L, BBP/DWR finish
- + Softshell: 7.3-oz., 100% polyester plain weave face with micro fleece back, 5K/2K, 3L, DWR finish

48152 5.11 Bristol Parka | Black 019, Coyote 120, Tundra 192, Dark Navy 724 | Softshell jacket is black, except for Dark Navy which features a matching Dark Navy softshell. | XS-4XL (3XL-4XL)

48152T 5.11 Bristol Parka | Black 019, Dark Navy 724 | L-4XL Tall |

BLACK 019	COYOTE 120	TUNDRA 192
DARK NAVY 724	<input checked="" type="checkbox"/> READY POCKET™	<input checked="" type="checkbox"/> ID PANELS



CONVERTIBLE FLEECE JACKET
 INCLUDED

5-IN-1 JACKET™ CLASSIC FIT



5.11's 5-in-1 Jacket offers five different configurations as a comprehensive all-weather duty solution. Breathable and waterproof, the outer-shell features mic loops, ID panels, hidden utility pockets, side zippers for CCW firearm access, and a detachable hood. The removable inner fleece offers mic loops, hidden utility pockets and TacTec System compatibility. The fleece's sleeves zip off, converting the lining to a standalone vest. So many ways to wear this jacket well. Imported.

- + Jacket: 5.2-oz., 100% nylon plain weave, 10K/6K, 2L, DWR finish
- + Fleece: 10.3-oz., 100% polyester anti-pilling fleece with 3.8-oz., 100% nylon overlays, DWR finish

48017 5-in-1 Jacket | Black 019, Dark Navy 724 | XS-4XL, M-2XL Tall (48017T 3XL+)

BLACK 019	DARK NAVY 724
<input checked="" type="checkbox"/> READY POCKET™	<input checked="" type="checkbox"/> ID PANELS



VALIANT DUTY JACKET CLASSIC FIT



Built on a 5-in-1 platform, the Valiant Duty Jacket consists of a high-performance shell and a removable matching softshell jacket that works as a standalone jacket or converts to a vest (also available separately). The outer-shell is waterproof, bloodborne pathogen-resistant* and features chest, forearm, internal, and hand-warmer pockets. The jacket also offers hidden mic loops and ID panels, a detachable hood, and our Quixip® System for rapid access to a concealed firearm. Imported.

- + Jacket: 5-oz., 100% polyester plain weave, 10K/6K, 2L, BBP/DWR finish
- + Softshell: 7.3-oz., 100% polyester plain weave face with micro fleece back, 5K/2K, 3L, DWR finish

48153 Valiant Duty Jacket | Black 019, Brown 108, Dark Navy 724, Sheriff Green 890 | XS-4XL (3XL-4XL)

48153T Valiant Duty Jacket | Black 019, Brown 108, Dark Navy 724, Sheriff Green 890 | L-4XL Tall |

48167 Valiant Softshell | Wear on its own or compatible with 48001, 48017, 48032, 48033, 48152, 48153, 48197, 48198 | Black 019, Brown 108, Dark Navy 724, Sheriff Green 890 | XS-4XL (3XL-4XL)

BLACK 019
BROWN 108
DARK NAVY 724

READY POCKET™
 ID PANELS



SIGNATURE DUTY JACKET CLASSIC FIT



Featuring a waterproof, breathable nylon bloodborne pathogen-resistant* lining, removable quilted liner, removable hood, and a bi-swing back for superior movement, the Signature Duty Jacket is an exceptional all-weather jacket. Side-seam zippers provide quick access to your firearm, while Tac-Tec-compatible pockets give you the storage you need. Other features include a back ID panel, badge tab kit, and hidden utility pockets. Imported.

- + Jacket: 3.6-oz., 100% nylon plain weave, DWR finish, 2.8-oz., 100% nylon taffeta inner lining with DWR
- + Liner: 1.9-oz., 100% nylon taffeta with 4.7-oz., 100% polyester polyfill insulation, 10K/6K, BBP

48103 Signature Duty Jacket | Black 019, Dark Navy 724 | XS-4XL Reg/Long

BLACK 019
DARK NAVY 724

READY POCKET™
 ID PANELS



DOUBLE-DUTY JACKET™ CLASSIC FIT



An ideal patrol solution for a wide range of climates, the Double-Duty Jacket features a wind- and water-resistant nylon shell, removable liner, front-facing cargo pockets, hidden utility pockets, and hidden hand-warmer pockets. The jacket is TacTec compatible, too. Imported.

+ Jacket: 3.6-oz., 100% nylon plain weave, DWR finish

48096 Double-Duty Jacket™ | Black 019, Dark Navy 724 | XS-4XL

BLACK 019

DARK NAVY 724

✓ READY POCKET™ ID PANELS



4-IN-1 JACKET CLASSIC FIT



Waterproof and breathable, the 4-in-1 Jacket features a removable hood, double storm flaps, side zippers for rapid access to a firearm and enhanced ventilation, TacTec-compatible pockets, a back ID panel, badge tabs, and hidden utility pockets. Imported.

+ Jacket: 5.2-oz., 100% nylon plain weave, 2.5L, DWR finish
 + Fleece: 10.3-oz., 100% polyester anti-pilling micro fleece with 3.8-oz., 100% nylon overlays, 10K/6K, BBP/DWR finish

48027 4-in-1 Jacket | Black 019, Dark Navy 724 | Short and Long sizes available in Black and Dark Navy only | S-6XL Short, Regular, Long

BLACK 019

DARK NAVY 724

✓ READY POCKET™ ID PANELS

FLEECE JACKET
INCLUDED**RESPONDER PARKA**

CLASSIC FIT



The Responder Parka is loaded to the hilt with performance and functionality. Responder Parkas feature blood-borne pathogen resistance and are built with waterproof, breathable, seam-sealed construction, and has 3M® reflective tape increases your safety factor. Parkas also feature removable hoods, zippered underarm vents and a stretch drawcord waist. Imported.

- + Jacket: 5.2-oz., 100% nylon plain weave, 10K/6K, 2.5L, DWR finish
- + Fleece: 8.6-oz., 100% polyester anti-pilling micro fleece with 3.8-oz., 100% nylon overlays, 5K/3K, DWR finish

48063 Responder Parka | Black 019, Dark Navy 724 | S-4XL

BLACK 019

DARK NAVY 724

 READY POCKET™CONVERTIBLE
SOFTSHELL
INCLUDED**FIRST RESPONDER PARKA**

CLASSIC FIT



Fully seam-sealed and waterproof, the First Responder Parka is bloodborne pathogen-resistant* and features storm flaps, adjustable cuffs, and a removable hood - all with a lower profile appearance. With our Quixip® System, you're able to reach your sidearm quickly, or add ventilation as needed. The parka includes a softshell liner that easily converts into a vest. Multiple pockets add utility. Don't be caught without it. Imported.

- + Parka: 5-oz., 100% polyester plain weave, 10K/6K, 2.5L, BBP/DWR finish
- + Softshell: 7.3-oz., 100% polyester plain weave face with micro fleece backer, 5K/2K, 3L, DWR finish

48197 First Responder Parka | Black 019, Dark Navy 724 | S-4XL |

BLACK 019

DARK NAVY 724

 READY POCKET™

3M | Scotchlite™
Reflective Material

FLEECE JACKET
INCLUDED

3M | Scotchlite™
Reflective Material

CONVERTIBLE
SOFTSHELL
INCLUDED



HIGH VIS RESPONDER PARKA CLASSIC FIT



The high-visibility and high-performance solution for today's first responders, our High Vis Responder Parka offers versatile warmth and dryness in the harshest of conditions. Responder Parka feature blood-borne pathogen resistance and are built with waterproof, breathable, seam-sealed construction. The High Vis version meets ANSI/ISEA 107-2015 Type R&P, Class 2 standards and has 3M® Scotchlite® reflective tape. Jackets also feature removable hoods, zippered underarm vents and a stretch drawcord waist. Imported.

- + Parka: 5.2-oz., 100% nylon plain weave, 10K/6K, 2.5L, DWR finish
- + Fleece: 8.6-oz., 100% polyester anti-pilling micro fleece with 3.8-oz., 100% nylon overlays, 5K/3K, DWR finish

48073 High Vis Responder Parka | Range Red 477, Royal Blue 693, Dark Navy 724 | S-4XL



✓ READY POCKET™

FIRST RESPONDER HIGH VIS PARKA CLASSIC FIT



The First Responder High Vis Parka offers exceptional weather protection in a versatile design. Seam-sealed and waterproof, the parka is bloodborne pathogen resistant*. Storm flaps, adjustable cuffs, a removable hood, and multiple pockets add utility, and the integrated Quixip® System affords quick access your sidearm or belt gear. The softshell liner converts into a vest. And with 3M® Scotchlite® tape and distinctive coloring, the jacket meets ANSI/ISEA 107-2015 Type R&P, Class 3 standards. Be ready, be visible. Imported.

- + Parka: 5-oz., 100% polyester plain weave, 10K/6K, 2L, BBP/DWR finish
- + Fleece: 8.6-oz., 100% polyester plain weave face, micro fleece backer, 5K/2K, DWR finish

48198 First Responder High Vis Parka | Royal Blue 693, Dark Navy 724 | S-4XL

48198T First Responder High Vis Parka | Royal Blue 693, Dark Navy 724 | L-4XL Tall |



✓ READY POCKET™

3M | Scotchlite™
Reflective Material



REVERSIBLE LONG HIGH VIS RAIN COAT

CLASSIC FIT



A configurable rain coat, and then some. The bottom of the Long High Vis Rain Coat detaches for situations you can handle in a parka-length coat. For situations that require high visibility, the coat reverses from standard patrol duty black to High Vis ANSI/ISEA 107-2015 Type R&P, Class 3 Certified, with 3M® Scotchlite® reflective tape. The coat's waterproof, breathable, seam-sealed nylon construction will keep you dry. And mic loops, badge tabs, and pass-through pockets will keep you ready. Sometimes, duty calls when it's pouring. What rain? Imported.

- + High Vis Side: 3.9-oz., 100% polyester oxford, coated, 10K/10K, DWR finish
- + Black Side: 4.3-oz., 100% nylon plain weave, coated, DWR finish

48125 Long High Vis Rain Coat | Black 019-reverses to High Vis Yellow 320 | S-3XL

BLACK 019



3M | Scotchlite™
Reflective Material



REVERSIBLE HIGH VIS 3-IN-1 PARKA™

CLASSIC FIT



The Reversible High Vis 3-in-1 Parka offers superior weather protection and reliable, High Visibility performance. The reversible outer shell is standard patrol duty black, with ANSI/ISEA 107-2015 Type R&P, Class 3 Certified and 3M® Scotchlite® reflective tape on the other side. The parka features mic loops, badge tabs, a removable hood, TacTec compatibility, hidden utility pockets, side zippers for unrestricted access to a firearm, and hand-warmer pockets. A removable fleece liner works as a standalone jacket. Dry, warm, responsive. Imported.

- + Parka: 6.2-oz., 100% polyester plain weave, 5K/3K, 2.5L, DWR finish
- + Fleece: 10.3-oz., 100% polyester anti-pilling fleece

48033 Reversible High Vis 3-in-1 Parka™ | Includes Fleece Liner | High Vis Yellow 320, reverses to Black 019 | XS-4XL

HV YELLOW 320



3M Scotchlite™
Reflective Material



BIKE PATROL JACKET

CLASSIC FIT



Specially engineered for mounted officers, the Bike Patrol Jacket offers exceptional utility and comfort in a crisp, professional, high-visibility profile. Built with underarm zippers for ventilation and an elasticized waistband, the Bike Patrol Jacket is waterproof, breathable, and flexible. Featuring 3M® Scotchlite® reflective tape, dual-entry hand pockets, and a badge tab and epaulette kit, this jacket is made for high-speed duty. Time to ride. Imported.

+ 6.5-oz., 96% polyester / 4% elastane face, brushed tricot backer, 10K/7K, 3L, DWR finish

45801 Bike Patrol Jacket | Royal Blue 693 | XS-3XL

ROYAL BLUE 693

READY POCKET™

3M Scotchlite™
Reflective Material



5-POINT BREAKAWAY VEST

REGULAR FIT

Offering both superior visibility and functional safety, the 5-Point Breakaway Vest features 3M® Scotchlite® reflective tape, breaks harmlessly away in case of mechanical entanglement, and meets ANSI/ISEA 107-2015 Type R&P, Class 2 standards. The vest also has mic loops, a badge tab, and front accessory pockets. Imported.

+ 4.4-oz., 100% polyester plain weave, DWR finish

49022 5-Point Breakaway Vest | High Vis Yellow 320 | Reg, 2XL+ |

HV YELLOW 320



XPRT® WATERPROOF PANT

REGULAR FIT

eVent



When the weather gets wet and mean, we'll meet you there with the ultimate rain pant. The XPRT Waterproof Pant features a fully seam sealed 3L nylon hardshell exterior and eVent® waterproof breathable (20K/15K), blood borne pathogen resistant membrane with waterproof YKK® zippers. The pant is designed and sized to be worn over our XPRT Tactical Pant and features an adjustable webbing belt plus belt loops that will accommodate standard duty belts. The pant also has loops for suspender compatibility and a removable belt.

Knees and rear hems are reinforced with Cordura® for durability and articulated seat and knee design allow for a wide range of motion. Lower legs feature zippered openings so the pants can be donned without removing your boots. Imported.

+ 6.2-oz., 100% nylon plain weave face, brushed tricot backer, 20K/15K, 3L, BBP/DWR finish

48333 XPRT Waterproof Pant | Black 019, Dark Navy 724 | S-3XL (3XL)

BLACK 019

DARK NAVY 724



XPRT® WATERPROOF JACKET

CLASSIC FIT

eVent



Fully seam sealed and loaded with operator-driven features, the XPRT Jacket features a 3L nylon hardshell exterior with eVent® waterproof breathable (20K/15K) blood borne pathogen resistant membrane. Adjustability and a versatile design allow heat management to help keep you comfortable and help stay focused on your mission while its articulated construction allows easy movement. Waterproof YKK® zippers, storm flap, adjustable cuffs and stowable hood ensure the weather stays out. The XPRT Jacket features internal comms routing and a host of pockets for stowing your snivel gear and other EDC essentials.

The XPRT Waterproof Jacket is designed to work with and be worn over our XPRT Tactical and XPRT Rapid shirts and was also designed to be worn under or over plate carriers. Imported.

+ 6.2-oz., 100% nylon plain weave face, brushed tricot backer, 20K/15K, 3L, BBP/DWR finish

48332 XPRT Waterproof Jacket | Black 019, Dark Navy 724 | S-3XL

BLACK 019

DARK NAVY 724

 READY POCKET™



APPROACH JACKET REGULAR FIT



Bringing three-layer hardshell performance with a tactical attitude, the Approach Jacket will be at home at the range, out on patrol or in the back country. The Approach features fully seam sealed nylon 3L hardshell fabric with a waterproof breathable membrane and a non-brushed tricot backer for durability.

The jacket has waterproof YKK® zippers, a two-way front zipper (with storm flap) and our RAPIDraw™ side-zippers for access to your concealed carry in any kind of weather. Articulated sleeves and adjustable hem, a stowable hood and cuffs allow you to adjust for best fit. Performance outerwear with tactical functionality. Imported.

+ 5.6-oz., 100% nylon plain weave face, tricot backer, 10K/10K, 3L, DWR finish

48331 Approach Jacket | Black 019, Tundra 192, Dark Navy 724 | XS-4XL

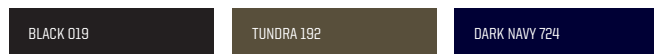

READY POCKET™



SABRE JACKET 2.0 CLASSIC FIT



The Sabre Jacket 2.0 provides a covert appearance and a wealth of tactical features. A high-performance 3-layer shell and waterproof, seam-sealed membrane insulate you from wind and water. Adjustable cuffs, a drop tail, and a removable hood add comfort and functionality. Then there's our patented Quixip® System for immediate access to a concealed firearm, a secure lumbar pocket, hand-warmer and zippered utility pockets and three zip-out ID panels. Stout and strong. Imported.

+ 6.5-oz., 96% polyester / 4% elastane plain weave face, tricot backer, 10K/7K, 3L, DWR finish

48112 Sabre Jacket 2.0 | Black 019, Coyote 120, Moss 191, Dark Navy 724 | XS-4XL

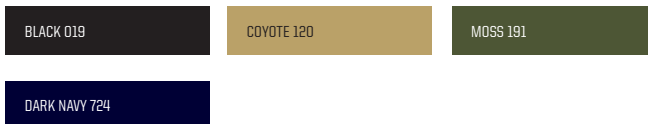

SIERRA SOFTSHELL

Our time-tested 3-layer softshell jacket features mechanical stretch and our ready pockets.





SIERRA SOFTSHELL REGULAR FIT



Built for practical use and maximum comfort in inclement weather, the Sierra Softshell is made from 100% polyester mechanical stretch woven fabric and fleece. The DWR finish keeps you dry, and low-profile chest pockets keep your phone, documents, or other items handy. Drawcord hem adjustments, lined hand-warmer pockets, and a two-way front zipper enhance a jacket that also offers our RAPIDDraw™ system for CCW access. Imported.

+ 7.3-oz., 100% polyester plain weave face, micro fleece backer, 5K/2K, 3L, DWR finish

78005 Sierra Softshell | Black 019, Burnt 117, Moss 191 | S-2XL |

BLACK 019

BURNT 117

MOSS 191

READY POCKET™



CHAMELEON SOFTSHELL JACKET

CLASSIC FIT



The Chameleon Softshell lives up to its name by blending with today's outerwear styles, yet retaining peak functionality. The jacket's 100% polyester bonded softshell fabric, lightweight mesh liner, adjustable cuffs, and drop tail provide protection from the elements. Hidden ID panels let you identify as needed, while 3 internal pockets provide additional storage. Keep you warm and ready. Imported.

+ 7.3-oz., 100% polyester plain weave face, micro fleece backer, 5K/2K, 3L, DWR finish

48099 Chameleon Softshell Jacket | 019 Black, Flat Dark Earth 131, Moss 191, Dark Navy 724 | XS-3XL

BLACK 019

FLAT DARK EARTH 131

MOSS 191

DARK NAVY 724

 ID PANELS



BIG HORN JACKET

CLASSIC FIT



Covert gets comfortable in the Big Horn Jacket. It features an all-weather shell, anti-pilling fleece lining, and an elastic waistband to keep you warm. Side zippers provide easy access to a concealed firearm – while hidden utility pockets and a zippered sleeve pocket give you smart storage options. Imported.

+ 4.5-oz., 100% nylon dobby, coated, DWR finish with 7.1-oz., 100% polyester anti-pilling micro fleece lining

48026 Big Horn Jacket | Black 019, Dark Navy 724 | XS-4XL

BLACK 019

DARK NAVY 724

READY POCKET™



RESPONSE JACKET™

CLASSIC FIT



Lightweight protection from the elements, the Response Jacket™ can be easily stashed in your go-bag or in the trunk of your ride. With handwarmer pockets and elasticized hem and cuffs, the Response helps keep you warm in cooler climates. Hidden ID panels at the front and rear. Imported.

+ 3.6-oz., 100% polyester plain weave, peached, coated, DWR finish

48016 Response Jacket | Black 019, Dark Navy 724 | XS-4XL

59094 POLICE ID Panel Set | Black 019 | 6" x 5" front, 12-1/2" x 9" back |

48017BF Blank Back ID Panel | Black 019 | 12-1/2" x 9" |

48017FF Blank Front ID Panel | Black 019 | 6" x 5" |

BLACK 019

DARK NAVY 724

READY POCKET™

ID PANELS



TACTICAL FLEECE CLASSIC FIT



Compatible with 5.11's 3-in-1 Parka™, Aggressor Parka™ and High-Vis 3-in-1 Parka, the Tactical Fleece adds an unbeatable layer of warmth, yet excels as a standalone jacket. It features wind-resistant fabric, abrasion-resistant chest and shoulder panels, mic loops, hidden utility pockets, internal chest pockets, zippered hand-warmer pockets, and side zippers. Imported.

+ 10.3-oz., 100% polyester anti-pilling micro fleece with 3.8-oz., 100% nylon taslon overlays with DWR finish

48038 Tactical Fleece | Black 019, Dark Navy 724, Sheriff Green 890 | XS-4XL

BLACK 019

DARK NAVY 724

SHERIFF GREEN 890

 READY POCKET™



JOB SHIRTS CLASSIC FIT

Provides superior versatility and utility while remaining tough, comfortable, and professional. The shirt offers warmth and breathability, and our exclusive Chest BreakThrough pocket utilizes a hook-and-loop divider to keep your gear within reach. Also featuring a no-roll collar, mic loops, side-seam hand-warmer pockets, and sleeve pocket. The Job Shirt is available in a range of styles, including a water-resistant version made with Storm Cotton and the value-minded Utility Job Shirt. Imported.

72321 Job Shirt with Canvas Collar | Fire Navy 720 | XS-3XL (3XL 72321T L-5XL Tall)

72301 Job Shirt with Denim Collar | Fire Navy 720 | XS-3XL

72314 1/4-Zip Job Shirt | Heather Grey 016, Black 019, Fire Navy 720 | XS-3XL; (72314T L-5XL Tall | Fire Navy 720 |

72363 Water-Repellent Storm Cotton® 1/4-Zip Job Shirt | Fire Navy 720 | XS-3XL

72441 Utility Job Shirt | Range Red 477, Fire Navy 720 | XS-4XL (3XL-4XL 72441T L-5XL Tall)

HEATHER GREY 016

BLACK 019

RANGE RED 477

FIRE NAVY 720

**NEW****DUTY RAIN SHELL**

REGULAR FIT



Monsoon ready? Yes. The Duty Rain Shell is the ultimate in waterproof breathable performance with a 10K/10K rating and a fully seam sealed lightweight construction.

Ergonomic design and a fixed hood afford full mobility while zippered hand pockets, patented side seam Quixip® system add versatility, ventilation and access. Available in traditional duty colors and 5.11's GE07® camo pattern. Imported.

+ 3.1-oz., 100% polyester plain weave, 10K/10K, 2.5L, DWR finish

48353 Duty Rain Shell Jacket | Black 019, Ranger Green 186, Dark Navy 724, Sheriff Green 890 | XS-3XL |

48353G7 GE07® Duty Rain Shell Jacket | Night 357, Terrain 865 | XS-3XL |

BLACK 019

RANGER GREEN 186

GE07 NIGHT 357

DARK NAVY 724

GE07 TERRAIN 865

SHERIFF GREEN 890



TAC DRY® RAIN SHELL CLASSIC FIT



Sharp, simple and low-profile, our Tac Dry shell is performance-ready. It features a 100% nylon, seam-sealed construction, storm flap, hook-and-loop storm cuffs, removable hood, hidden ID panels, five smart pockets, and Quixip® rapid access to your firearm. Imported.

+ 2.7-oz., 100% polyester mini ripstop, 15K/15K, 2.5L, DWR finish

48098 Tac Dry Rain Shell | Black 019, Dark Navy 724 | XS-3XL (3XL

BLACK 019

DARK NAVY 724

 READY POCKET™  ID PANELS



PATROL RAIN PANT REGULAR FIT



Featuring waterproof, breathable, seam-sealed construction, an elasticized waistband with our Keeper+™ belt loops, abrasion-resistant kick-panels, and hook-and-loop ankle closures, the Patrol Rain Pant will keep out the water. With pass-through pockets for direct access to your PDU®, cargo pockets, articulated knees, a gusseted construction for superior movement, and 12" boot zippers, you'll be optimized for wet-weather duty. Imported.

+ 3.9-oz., 100% polyester twill coated body, 5K/5K, DWR finish. 3.9-oz., 100% nylon plain weave coated overlay, DWR finish

48057 Patrol Rain Pant | Black 019 | S-3XL, regular (32.5") or long (35.5") length

BLACK 019



PACKABLE JACKET REGULAR FIT



Engineered with a durable, 100% polyester shell, the Packable Jacket features mic loops, a hidden utility pocket, and hand-warmer pockets. Best of all, it folds cleanly into its own pocket so you can carry it anywhere. Tossed in your truck or stowed in your gear bag, it's built to roll with you. Imported.

+ 2.5-oz., 100% polyester taffeta, DWR finish

48035 Packable Jacket | Black 019, Dark Navy 724, Sheriff Green 890 | XS-4XL

48052 Lined Packable Jacket | Black 019 | XS-4XL



PACKABLE



PACKABLE OPERATOR JACKET REGULAR FIT



With mic loops, a hidden utility chest pocket, and a stowable hood, the water-resistant, polyester Packable Operator Jacket is a tactical must. It even folds covertly into its own pocket and stores easily. Imported.

+ 2.5-oz., 100% polyester taffeta, DWR finish

48169 Packable Operator Jacket | Black 019, Dark Navy 724, Sheriff Green 890 | XS-4XL



PACKABLE



PENINSULA HYBRID

Perfect layering solution with a Primaloft® insulated body and stretch terry knit arms.





PENINSULA HYBRID JACKET REGULAR FIT



Part insulator, part ultra-tough lightweight jacket, the Peninsula Hybrid has it all. The body is engineered with 5.11's mini ripstop fabric with a durable water repellent finish and Primaloft® insulation for warmth. The front and upper back body panels are quilted for just enough insulation and the sleeves and side body panels are a soft, flexible knit terry. It has an internal storm flap for extra protection against the wind, zippered hand pockets with internal RAPIDraw™ pass through for seamless access to your CCW, and a hidden left chest pocket with an internal media port. High tech warmth meets advanced comfort: The Peninsula Hybrid is sure to be the smartest jacket you'll wear. Imported.

- + 1.6-oz., 100% polyester mini ripstop with DWR finish and 8.8-oz., 90% polyester / 10% elastane knit terry with a peached finish
- + Body insulated with 1.8-oz., 100% polyester Primaloft® Black Series

78022 Peninsula Hybrid Jacket | Black 019, Tundra/Sage Green 192 | XS-3XL

BLACK 019

TUNDRA 192

READY POCKET™



PENINSULA INSULATOR JACKET REGULAR FIT



So lightweight yet so warm, the full-zip Peninsula Insulator Jacket is built to ward off the cold and other surly elements. The Primaloft® Black Series Insulation offers ultimate softness, warmth and comfort, while pockets with RAPIDDraw™ pass-through and a hidden chest pocket keep you confident and ready. The main body features our extra tough mini ripstop fabric with plain weave overlays and a DWR finish. But there's more. The Insulator folds into a removable stuff sack that fits in a hand pocket. Portability rules. Imported.

- + 1.6-oz., 100% polyester mini ripstop body, DWR finish. 2.4-oz., 100% polyester plain weave lining, DWR finish.
- + Body insulated with 2.9-oz., 100% polyester Primaloft® Black Series, sleeves insulated with 2.4-oz., 100% polyester Primaloft® Black Series

48342 Peninsula Insulator Jacket | Black 019, Moss 191 | XS-3XL

BLACK 019

MOSS 191

 READY POCKET™



PENINSULA INSULATOR SHIRT JACKET REGULAR FIT



Staying warm doesn't have to mean compromising looks and tactical capability. The lightweight Peninsula Insulator Shirt Jacket proves that. Its ultra-warm, super-soft Primaloft® Black Series Insulation is contrasted by tough polyester mini ripstop with plain weave overlays and a DWR finish. The Insulator Shirt features a RapidDraw™ center front snap placket for easy access to a CCW, plus Ready Pockets on the chest with an added layer of patch pockets. For frosty camping trips or cold mornings on the range, be sure to layer under this handsome devil to show off your savvy shirt jacket style. Imported.

- + 1.6-oz., 100% polyester mini ripstop body, 2.4-oz., 100% polyester plain weave lining, DWR finish.
- + Insulated with 40GM 100% polyester Primaloft® Black Series

72123 Peninsula Insulator Shirt Jacket | Black 019 (solid), Moss Heather 276 | XS-3XL

BLACK 019

MOSS HTHR 276

 READY POCKET™



RAPPEL JACKET

REGULAR FIT



Whether you're heading to the highest peak, or out on a windy range for a little target practice, the Rappel Jacket wraps you in smart tactical utility. Zippered hand and chest pockets hold your high-tech tools tight, and zippered RAPIDraw™ pass-through openings keep your CCW close at hand. Reinforced woven fabric at the elbows, shoulders and hood add durability and a contrasted finish. When the winds gust and the rain pours, don the handy, three-panel hood, zip up and let the durable water repellent finish handle the rest. Imported.

+ 10.4-oz., 71% cotton / 27% polyester / 2% elastane double faced dobby body with 4.7-oz., 87% polyester / 13% elastane plain weave overlays

78018 Rappel Jacket | Black 019, Kangaroo 134, Flint 258, Peacoat 787 | XS-2XL |

BLACK 019

KANGAROO 134

FLINT 258

PEACOCK 787



APOLLO TECH FLEECE

REGULAR FIT



Sure, it keeps you comfy and cozy, but that's where the Apollo Tech Fleece's softness ends. Hand welt pockets feature internal RAPIDraw™ pass through access to a CCW. And even though two-sided brushed microfleece is easy to wear, it won't wear easily with the protection of a two-sided anti-pilling treatment. We added another rugged edge with nylon N6 overlays on the collar, back body/shoulders and other key areas. So, bring your heavy pack and don't hold back, the Apollo can handle the rigors of duty, training or trekking and come out looking good at the end of the day. Imported.

+ 7.2-oz., 100% polyester anti-pilling micro fleece with 3.7-oz., 100% nylon plain weave overlay, water-resistant finish

78016 Apollo Tech Fleece | Black 019, Coin 352 | XS-3XL

BLACK 019

COIN 352

BRAXTON

Medium-weight stretch fabric with a DWR finish, and sleek profile make the Braxton great choice for everyday outerwear.





BRAXTON JACKET REGULAR FIT

The lightweight feel of the Braxton is merely a cover for its high tactical functionality. Engineered with a polyester/elastane blend and durable water repellent finish, the Braxton wraps you in warmth without bulk. The chest features four pockets: two ReadyPocket™ compartments and two horizontal zippered pockets. Front hand pockets with zipper closures include internal RAPIDraw™ pass through for quick access to your CCW. The hood comes in handy when the weather isn't cooperating with your weekend plans, but it packs into the collar when things clear up. The clean lines and military-inspired styling of the Braxton can go casual or dress up for a night out. Add it to your style arsenal ASAP. Imported.

+ 9-oz., 92% polyester / 8% elastane double weave, DWR finish

78023 Braxton Jacket | Black 019, Peacoat 787 | XS-3XL

BLACK 019

PEACOCK 787



REVOLVER REVERSIBLE JACKET REGULAR FIT

No matter how rugged your adventure or work gets, you have options with the Reversible Jacket. The poly/cotton ripstop outer jacket reverses to show its inner fleece jacket. Talk about adapting on the fly. And when you need to act quickly, zip hand pockets with internal RAPIDraw™ pass through give you seamless access to your CCW. The rib-knit collar, sleeve cuffs and waistband give this jacket the subtle contrasts you need to wear it just about anywhere. Imported.

- + Outer Jacket: 6.2-oz., 65% polyester / 35% cotton ripstop with Teflon™ finish for stain and soil resistance
- + Inner Jacket: 5.9-oz., 100% polyester anti-pilling micro fleece

78017 Reversible Jacket | TDU Green 190 (reverses to Charcoal Heather), Dark Navy 724 (reverses to Ensign Blue Heather) | XS - 3XL

TDU GREEN 190

DARK NAVY 724



Reverses to heather micro-fleece

SURPLUS JACKET

Military styling matches up with our mechanical-stretch Flex-Tac® canvas for durability, versatility and distinct style.





SURPLUS JACKET REGULAR FIT

Classic military styling, advanced utility, and modern comfort converge in the Surplus Jacket. The materials that make up this beast are worth kicking it off. A bi-swing back adds freedom of movement, and smart pockets provide outstanding utility and a Teflon™ treatment repels stain and soil. ReadyPocket™ compartments on the chest are topped off with patch pockets. Front cargo pockets feature hidden snap closures, and side entry YKK® zipper pockets include internal RAPIDDraw™ pass through. The Surplus' hood rolls up and zips into the collar when you don't need it. Timeless lines, progressive functionality, and all-important tactical capability: The Surplus has plenty of extras built-in. Imported.

+ 6.4-oz., 67% polyester / 33% cotton mechanical stretch Flex-Tac® canvas, Teflon™ finish for stain and soil resistance

78021 Surplus Jacket | Black 019, Kangaroo 134, Ranger Green 186 | XS-3XL

BLACK 019

KANGAROO 134

RANGER GREEN 186

 READY POCKET™



CRUISER HOODIE REGULAR FIT

This lightweight hoodie is heavy on style and features. Built for working out or just hanging out, the moisture wicking material in the Cruiser Hoodie helps your body breathe. The kangaroo pocket is handy for quickly stowing your keys or phone and the flexible, self-fabric draw cords add warmth when you need it. Contrast thread at the bottom hem adds a unique accent, while the tonal 5.11 logo on the front right shoulder and Scope logo on the upper left sleeve round out this athletic, tactical look. Imported.

+ 4.1-oz., 60% cotton / 40% polyester jersey with moisture wicking

72139 Cruiser Performance L/S Hoodie | Black 019, Stone 070, Ranger Green 186, Blue Blood 622 | XS-2XL |

BLACK 019

STONE 070

RANGER GREEN 186

BLUEBLOOD 622



PACKABLE RAID VEST REGULAR FIT



In the heat of the moment, all your energy and focus is on the mission. All the more reason to have 5.11's Packable Raid Vest on hand. Engineered to excel in demanding operational environments, built with woven polyester for durability and offers outstanding fit. Pull out panels on the chest and the back body can be customized to provide identification for yourself and your agency, or the vest itself can be customized. Best of all, the Raid Vest packs into its own hand pocket so its easy to keep within reach. Imported.

+ 2.4-oz., 100% polyester plain weave, DWR finish

80027 Packable Raid Vest | Black 019, Dark Navy 724, Sheriff Green 890 | XS-3XL

BLACK 019

DARK NAVY 724

SHERIFF GREEN 890

 PACKABLE



COVERT VEST

REGULAR FIT



It looks like a regular vest, but that's the point. 5.11®'s Covert Vest defies the elements with 100% polyester bonded softshell fabric, and it flaunts perception with TacTec-compatible hidden chest pockets and RAPIDdraw™ CCW pass-through pockets. This isn't a regular vest, just like you're not a regular guy. Imported.

+ 7.3-oz., 100% polyester plain weave face with micro fleece backer, 3L, DWR finish

80016 Covert Vest | Black 019, Moss 191, Dark Navy 724 | S-3XL

BLACK 019

MOSS 191

DARK NAVY 724



TACLITE PRO VEST

CLASSIC FIT



Built with our hard wearing Taclite® ripstop, with quad-stitching and bartacking reinforcements at the pockets, seams, and major stress points the Taclite Pro Vest can haul it all. The smart shoulder design and half-collar maximize weight distribution for comfort and ease of wear. The vests feature 18 pockets, including twin CCW pockets at the chest, dual water bottle pockets at the back, a tablet pocket, and pockets sized for AR magazines. Imported.

+ 6.2-oz., 65% polyester / 35% cotton ripstop with Teflon™ for stain and soil resistance.

80008 Taclite® Pro Vest | Black 019, TDU Khaki 162 | S-3XL

BLACK 019

TDU KHAKI 162

READY POCKET™

WOMEN'S APPAREL

From mission-specific pants to comfortable athletic tights, 5.11 has new options for you.

Vista Pant (p 110)



THE APEX

With Flex-Tac® mechanical stretch canvas and a low-profile cargo pocket, the Apex Pant, is ready for you.



STRETCH FABRIC AT WAIST

REAR PHONE/MAG POCKETS

CARGO POCKETS WITH DIVIDERS

GUSSETED CONSTRUCTION

FLEX-TAC® STRETCH CANVAS

STRAIGHT FIT



WOMEN'S APEX™ PANT STRAIGHT FIT

Flex-Tac® mechanical stretch canvas combined with a Teflon™ finish to deliver unimpeded mobility and supreme stain performance in a woman's pant. The Women's Apex Pant features a comfort waistband, low profile cargo pockets and extra rear pockets. Waist pockets offer covert storage for flex-cuffs and a handcuff key hidden at the rear and inside bottom hem. Imported

- + 6.4-oz., 67% polyester / 33% cotton Flex-Tac® mechanical stretch canvas and a Teflon™ finish for stain and soil resistance
- + 10 pockets including low-profile cargo pockets
- + Comfort waistband w/ flex cuff tunnel

64446 Women's Apex™ Pant | Straight Fit | Black 019, Khaki 055, Ranger Green 186, Dark Navy 724 | 0-20 evens, Regular and Long inseams |

BLACK 019

KHAKI 055

RANGER GREEN 186

DARK NAVY 724



STRETCH



PHONE POCKET





WOMEN'S 5.11 STRYKE® PANT STRAIGHT FIT

The 5.11 Stryke Pant is what all other pants want to be. Made of our patent-pending two-way Flex-Tac® mechanical stretch fabric, finished with stain- and soil-resistant Teflon™, the 5.11 Stryke pant is exceptionally durable. With 12 pockets, reinforcements in strategic places, it's high-performance functionality at its finest. Imported.

- + 6.8-oz. 65% polyester / 35% cotton Flex-Tac® mechanical stretch ripstop with Teflon™ finish for stain and soil resistance.
- + 12 pockets, cargo pockets feature internal organization
- + Fixed waistband

64386 Women's Stryke Pant | Black 019, Khaki 055, Storm 092, Coyote 120, TDU Green 190, Tundra 192, Dark Navy 724 | 0-20 evens, Inseams: Regular = 31", Long = 35" |

BLACK 019	KHAKI 055	STORM 092
COYOTE 120	TDU GREEN 190	TUNDRA 192
DARK NAVY 724	 STRETCH  PHONE POCKET	



PHONE/MAG
POCKETS

COMFORT
WAISTBAND

CARGO POCKETS
WITH DIVIDERS

GUSSETED
CONSTRUCTION

FLEX-TAC®
STRETCH RIPSTOP

STRAIGHT FIT

NEW

WOMEN'S ICON PANT

STRAIGHT FIT

Input from female professionals of a wide range of careers and specific assignments has been incorporated into every part of this pant. Manufactured with durable 80/20 Flex-Tac® mechanical stretch ripstop fabric, the Women's Icon Pant is reinforced at strategic locations throughout and features a gusseted design. Strategic pockets have been strengthened with Nylon 6 as well. Among its many other features, this pant sports 8 pockets, including a pair of mag pockets inside the internally divided cargo pockets, a comfort waistband, a Teflon™ finish for stain and soil resistance.

- + 80% poly/20% cotton Flex-Tac® ripstop, 6.8 oz., w/ Teflon™ finish
- + Cargo pockets w/inside dividers, rear yoke pockets
- + Comfort waistband

64447 Women's Icon Pant | Straight Fit | Black 019, Khaki 055, Ranger Green 186, Dark Navy 724 | 0-20 evens, Regular or Long inseams |

BLACK 019

KHAKI 055

RANGER GREEN 186

DARK NAVY 724

STRETCH

PHONE POCKET



ABR™ PRO

Lightweight and durable, the ABR Pro Pant is now available in a Women's fit and ready for your life's adventures.



PHONE/MAG
POCKETS

COMFORT
WAISTBAND

CARGO
POCKETS

GUSSETED
CONSTRUCTION

DOUBLE-LAYERED
KNEES (KNEEPAD READY)

FLEXLITE™
STRETCH RIPSTOP

STRAIGHT FIT

NEW

WOMEN'S ABR™ PRO PANT STRAIGHT FIT

Manufactured with durable, extremely lightweight FlexLite™ stretch ripstop fabric with a Teflon™ finish, the Women's ABR Pro Pant is reinforced at strategic locations throughout and is knee pad ready. Input from female professionals of many different assignments has been incorporated at every level. Among its many features, this pant boasts a comfort waistband, articulated knees, and 5.11's fade resistant utility strap. The seat and the knees have been double-reinforced and selected pockets up-armored with Nylon 6, all to refuse wear and tear. Imported.

+ 5.4-oz. 71% polyester / 29% cotton FlexLite ripstop with Teflon™
+ 9 pockets including our trademarked slash pockets and one rear yoke utility pocket

64445 Women's ABR™ Pro | Straight Fit | Black 019, Khaki 055, Kangaroo 134, Ranger Green 186, Dark Navy 724 | 0-20 evens, Regular and Long inseams |

BLACK 019 KHAKI 055 KANGAROO 134

RANGER GREEN 186 DARK NAVY 724

 STRETCH  PHONE POCKET





WOMEN'S TACLITE® PRO PANT AND SHORT

RELAXED FIT

The Taclite® Pro Pant features eight pockets, our durable ripstop fabric, and a Teflon™ finish for stain- and soil-resistance. Double reinforced at the seat and knees mean these pants won't wear out, no matter how much sitting, hustling, and crawling through the brush you do. If you've ever wondered what it's like to wear comfortable, invincible pants, here's your opportunity. Imported.

- + 6.2-oz. polyester / cotton Taclite® ripstop fabric with a Teflon™ finish for stain and soil resistance
- + 8 pockets including our trademarked strap-and-slash seat pockets
- + Action waistband

64360 Women's Taclite Pro Pant | Charcoal 018, Black 019, TDU Khaki 162, TDU Green 190, Tundra 192, Dark Navy 724 | 2-20 even, Inseams: Regular = 30"-32", Long = 34"-36" |

63071 Women's Taclite Short | 9" inseam | Black 019, TDU Khaki 162, TDU Green 190, Dark Navy 724 | Women's 2-20 even sizes |

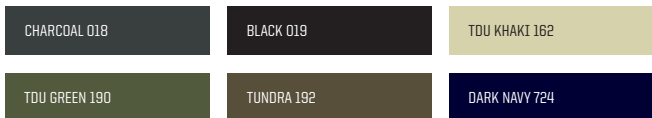

WOMEN'S 5.11 TACTICAL® PANT

RELAXED FIT

The first tactical pant-the true original that's been serving public safety professionals for decades. Made of 100% cotton canvas, the 5.11 Tactical Pant is constructed for superior durability, comfort, and performance. Featuring our trademarked strap-and-slash pockets, an adjustable waist, double-reinforcement at the seat and knees, and heavy stitching. There's only one original. Imported.

- + 8.8-oz. 100% cotton canvas
- + 7 pockets including our trademarked strap-and-slash seat pockets
- + Action waistband

64358 Women's 5.11 Tactical Pant | Black 019, Khaki 055, Fire Navy 720 | 2-20 even, Inseams: Regular = 30"-32", Long = 34"-36" |





WOMEN'S FAST-TAC™ CARGO PANT STRAIGHT FIT

You walk the walk of pure professionalism and performance. Now you can wear it too. The Women's Fast-Tac™ Cargo Pant is by far the strongest finisher in the lightweight class. Gusseted seams and double and triple stitching are just the beginning. The 4.7-oz. Fast-Tac 100% polyester ripstop fabric is water- and abrasion-resistant yet easy to wear. A comfort waistband with 7 belt loops is also CCW friendly. Nine pockets, including dual magazine and cargo pockets, plus a device ready welt pocket provide excellent cover for all your essentials. Best of all, the Fast-Tac Urban Cargo Pant looks great from dawn patrol to night duty. Imported.

- + 4.7 oz. 100% polyester Fast-Tac™ fabric with DWR finish
- + 9 pockets, including back yoke pockets and thigh cargo pockets
- + Comfort waistband

64419 Women's Fast-Tac™ Cargo Pant | Charcoal 018, Black 019, Khaki 055, Dark Navy 724 | 0-20 evens, Regular (32"), Long (35") inseams |

CHARCOAL 018

BLACK 019

KHAKI 055

DARK NAVY 724

PHONE POCKET



WOMEN'S FAST-TAC™ URBAN PANT STRAIGHT FIT

Amazingly lightweight, water-resistant and every-day ready, the Women's Fast-Tac™ Urban Pant wears like a walking power play. The flexible waistband with 7 belt loops is CCW friendly. Five pockets total, including a welted front pocket that makes the perfect place to store your favorite phone. And the feather-light and tough Fast-Tac 4.7-oz. 100% polyester ripstop fabric will put this pant at the front of your closet. Imported.

- + 4.7-oz. 100% polyester Fast-Tac™ fabric with DWR finish
- + 5 pockets, including back yoke pockets and front phone pocket
- + Comfort waistband

64420 Women's Fast-Tac™ Urban Pant | Charcoal 018, Black 019, Khaki 055, Dark Navy 724 | 0-20 evens, Regular (32"), Long (35") inseams |

CHARCOAL 018

BLACK 019

KHAKI 055

DARK NAVY 724

PHONE POCKET

THE AVALON

Super comfortable stretch fabric with a washed finish and eight pockets make the Avalon one of our favorite new casual pants.





NEW

AVALON PANT

SLIM FIT

Functional, stretchable mobility is the key asset of the slim fit Avalon pant. Precision designed with input from female professionals at every level, they feature reinforced back belt loops, eight pockets for your everyday carry including two hidden back yoke pockets. The Avalon Pant is a slim-fit garment. Imported.

- + 8.3-oz., 97% cotton / 3% elastane stretch canvas with an enzyme wash
- + 8 pockets, including rear yoke pockets and front utility pockets
- + Waistband with built-in stretch

64449 Avalon Pant | Slim Fit | Stone 070, Ranger Green 186, Black Ash 267 | 0-16 evens regular or 2-14 evens long |

STONE 070

RANGER GREEN 186

BLACK ASH 267



STRETCH



PHONE POCKET





VISTA PANT SLIM FIT

It's built to flex and move throughout your day with bi-stretch double weave fabric and a contoured elastic waistband, but the Vista Pant is also equipped with essential tactical features. First: The pocket count tops out at eight, with nylon-6 reinforced hand pockets, two cargo drop pockets, and two back mag pockets. Second: The Vista's slim fit and ankle length will look smart with a tucked in 5.11 button-up, a tee and blazer, or a slouchy sweater or hoodie. For tactical capability and versatile style, the Vista offers impressive views. Imported.

- + 6.4-oz., 91% polyester / 9% elastane 4-way stretch double weave with Enduro-Flex™ properties
- + 8 total pockets, including two cargo pockets and two rear yoke pockets
- + Contoured elastic waistband

64441 Vista Pant | Black 019, Ranger Green 186 | 0-16 even sizes, regular (28") and long (30") lengths |



STRETCH PHONE POCKET



NEW ASCENT PANT SKINNY FIT

The sleek, skinny-fit Ascent Pant is a comfortable, ankle-length pant that'll function as superbly in admin activities as it will rigorous ones. Durable stretch cotton twill fabric lets you move. Ten pockets, including two in the back for mags and a hidden one at the fly, lets you handle business if you need to. Note the Nylon 6 reinforcement for the knife pocket. Imported.

- + 8-oz., 98% cotton / 2% elastane stretch twill with a peached finish and rinse washed
- + 10 pockets, including hidden fly pocket and rear yoke pockets

64450 Ascent Pant | Skinny Fit | Stone 070, Volcanic 098, Ranger Green 186 | 0-16 evens regular or 2-14 evens long inseams |

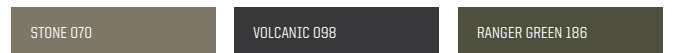

STRETCH PHONE POCKET

**NEW****NATASHA TIGHT** SKINNY FIT

Ergonomically cut pattern with a textured crackle finish has you ready for a workout or a relaxed weekend. There's reverse coil zippered pockets at the hips for your EDC and the wide diamond mesh waistband maximize support and comfort while you run or lift. Imported.

- + 8.6-oz., 88% nylon / 12% elastane single jersey knit with Enduro-Flex™ properties plus moisture wicking and odor-control
- + Low-profile, zippered pockets easily fit your phone

| **67007 Natasha Tight** | Skinny Fit | Black 019 | XS-XL |

BLACK 019





HARPER TIGHT SKINNY FIT

Support, comfort, utility, and mobility reign supreme in the Harper Tight. So, whether you're on a hike, at the range, or dressing it up for work, the Harper's nylon / elastane blend is sure to make you feel and look amazing. So maybe we rename it the Sharper Tight? Nah, let's talk features. The Harper has coated fabric panels, belt loops, an accordion style treatment at the front and back of each knee, and a wicking and anti-odor finish. There are also patched-on thigh pockets with locked down zippers to securely carry your smart phone and other daily basics. Gotta get the Harper: The tight that's built right. Imported.

- + 9.4-oz., 80% nylon / 20% elastane jersey with Enduro-Flex™ properties plus moisture wicking and odor-control
- + Reinforced waistband with belt loops for holster wear
- + Low-profile, zippered pockets easily fit your phone

67008 Harper Tight | Black 019, Ranger Green 186, Fig 560 | 0-16 even sizes |

BLACK 019

RANGER GREEN 186

FIG 560





WOMEN'S FREEDOM FLEX SHIRT REGULAR FIT

Built for any task, anywhere, this shirt delivers ultimate comfort with mechanical stretch fabric, wicking finish and perforated sections throughout. RAPIDDraw™ placket and utility pockets complete its tactical purpose. Imported.

- + Main fabric is 3.3-oz., 100% polyester mechanical stretch fabric with Enduro-Flex™ properties, contrast panels are 100% polyester perforated mechanical stretch fabric with Vent-Tac™ properties
- + Front chest pockets and pen pocket on left sleeve

61311 Women's Freedom Flex™ Short-Sleeve Shirt | Black 019, Python 256, Plum 494 | XS-XL |

BLACK 019

PYTHON 256

PLUM 494



WOMEN'S 5.11 STRYKE® SHIRTS REGULAR FIT

The 5.11 Stryke Shirt is built with Flex-Tac® mechanical stretch fabric, treated with stain- and soil-resistant Teflon™, has a rain-repellent finish, and it comes with 5.11's patented Ready Pockets, pen pockets, and sleeve roll-up tabs. Imported.

- + 4.8-oz. 62% polyester / 38% cotton Flex-Tac® mechanical stretch ripstop with Teflon™ finish
- + Ready Pocket™ and patch pocket on left and right chest, pen pocket on left sleeve

61325 Women's 5.11 Stryke® Short-Sleeve Shirt | Black 019, Khaki 055, TDU Green 190, Dark Navy 724 | XS-XL |

62404 Women's 5.11 Stryke® Long-Sleeve Shirt | Black 019, Khaki 055, TDU Green 190, Dark Navy 724 | XS-XL |

BLACK 019

KHAKI 055

TDU GREEN 190

DARK NAVY 724





WOMEN'S FAST-TAC™ SHIRTS REGULAR FIT



With a Fast-Tac™ shirt on your back, you'll stay cool, calm and ready to handle just about anything. Made with our 100% polyester Fast-Tac™ 4.7-oz ripstop fabric with a water-resistant finish, plus double- and triple-needle stitching it's lighter and stronger than ever. Front patch pockets and 5.11's patented pen pocket on the left sleeve give you smart storage options and are even embroidery friendly. Worn tucked in or out, this shirt radiates understated style and big-time confidence. Available in men's and women's. Includes badge tab and epaulette kit. Imported.

- + 4.7-oz., 100% polyester Fast-Tac™ ripstop with water resistant finish
- + Patch pocket on left and right chest, pen pocket on left sleeve

62388 Women's Fast-Tac™ Long-Sleeve Shirt | Charcoal 018, Black 019, Khaki 055, Dark Navy 724, Uniform White 992 | XS-XL |

61314 Women's Fast-Tac™ Short-Sleeve Shirt | Charcoal 018, Black 019, Khaki 055, Dark Navy 724, Uniform White 992 | XS-XL |



WOMEN'S TACLITE® PRO SHIRT REGULAR FIT



This shirt is rugged, lightweight, breathable, finished with Teflon™, and made of polyester/cotton ripstop fabric. It has hidden utility pockets, pen pockets, and adjustable cuffs. Imported.

- + 4.2-oz., 65% polyester / 35% cotton Taclite® ripstop with a Teflon™ finish for stain and soil resistance.
- + Ready Pocket™ and patch pocket on left and right chest, pen pocket on left sleeve

62070 Women's Taclite Pro Long-Sleeve Shirt | Black 019, TDU Khaki 162, TDU Green 190, Dark Navy 724 | XS-XL |





WOMEN'S RAPID HALF-ZIP REGULAR FIT

Made from a flexible polyester/spandex blend and mélange jersey, the Women's Rapid Half Zip provides stretch comfort for any active occasion. The moisture-wicking body keeps you warm and dry, while a zippered sleeve pocket and loop-sided panel offer simple storage and subtle styling. Imported.

- + Body fabric is 7.1-oz., 92% polyester / 8% elastane mélange jersey with odor-control and wicking finish; contrast fabric is 6.4-oz., 91% polyester / 9% elastane bi-stretch double weave

62381 Women's Rapid Half Zip | Charcoal 018, Blush 498, Sage Green 831 | XS-XL |

CHARCOAL 018

BLUSH 498

SAGE GREEN 831



ATLAS JACKET REGULAR FIT

The ideal balance of form and function make the Atlas Jacket perfect as an outer layer. Its lightweight construction consists of a polyester/elastane blend bonded to a 100% polyester heather jersey backer with a durable water repellent finish. Its tactical strengths show up big in hand pockets with RAPIDDraw™ pass through for quick, convenient CCW access, articulated areas for optimal range of motion, and discrete chest pockets. Whether you're running errands or headed out of town for the weekend, the Atlas keeps you looking great and feeling confident. Imported.

- + 8.5-oz., 92% polyester / 8% elastane plain weave with a sanded face and durable water resistant finish, bonded to 100% polyester heather jersey backer

38081 Atlas Jacket | Black 019, Major Brown 367 | XS-XL |

BLACK 019

MAJOR BROWN 367



EMMA FULL ZIP FITTED

Don't let the weather keep you inside today, or any day. Pull on the Emma Full Zip and feel your inner super heroine bubble to the surface. The cotton/poly blend adds a layer of comfort and warmth, and the elastane gives you all the freedom you need to move with purpose. But the beauty of this hoodie is in the details, with quilting accents, hand pockets with concealed zippers and a wide bottom hem that lays flat. Imported.

+ 8.8-oz., 86% cotton / 10% polyester / 4% elastane scuba knit

62079 Emma Full Zip | Black 019, Tundra 192, Cabernet 569 | XS-XL |

BLACK 019

TUNDRA 192

CABERNET 569



QUIET WARRIOR

HONORING THOSE WHO SERVE

5.11 is proud to share stories of first responders and law enforcement professionals who have gone above and beyond the call of duty in service to their communities.

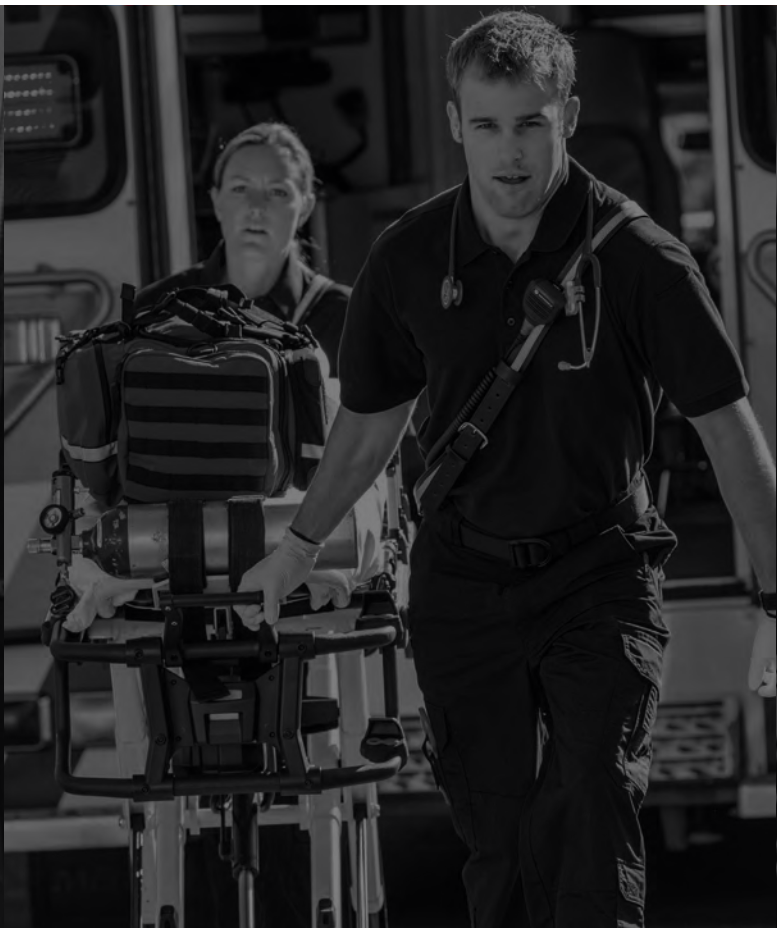
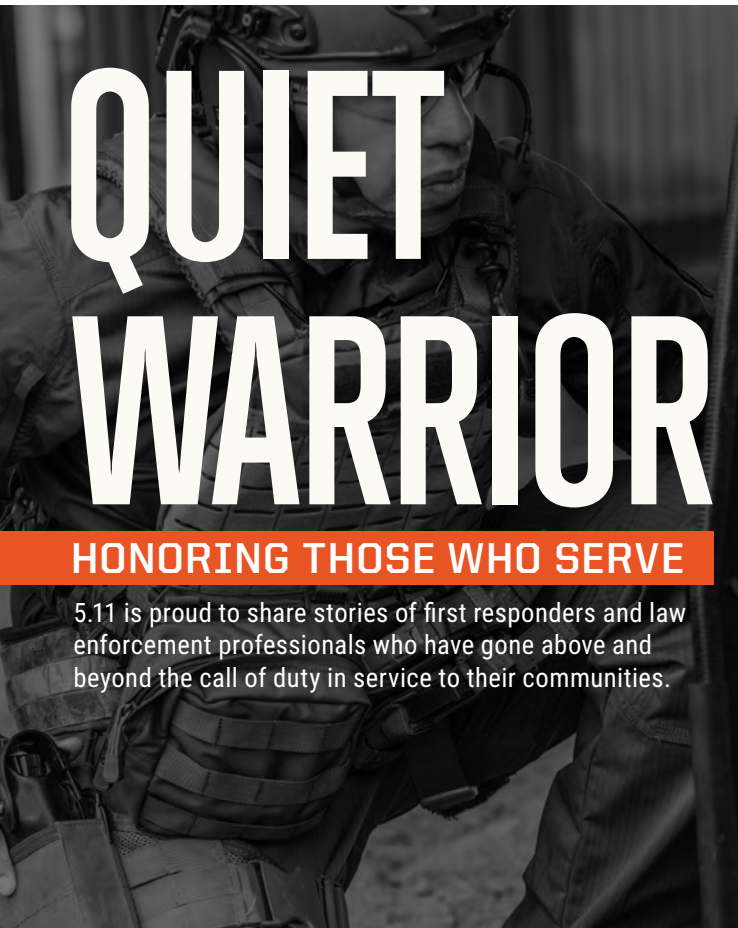



CLASS A FLEX-TAC POLY/WOOL 122



MOUNTED PATROL 128



5.11 STRYKE® PATROL DUTY UNIFORM. 124
NYPD 5.11 Stryke® Pants 126
Class A Fast-Tac® Twill 127



PATROL DUTY UNIFORMS. 130
Uniform Outer Carriers 134



XPRT® TACTICAL UNIFORMS 136

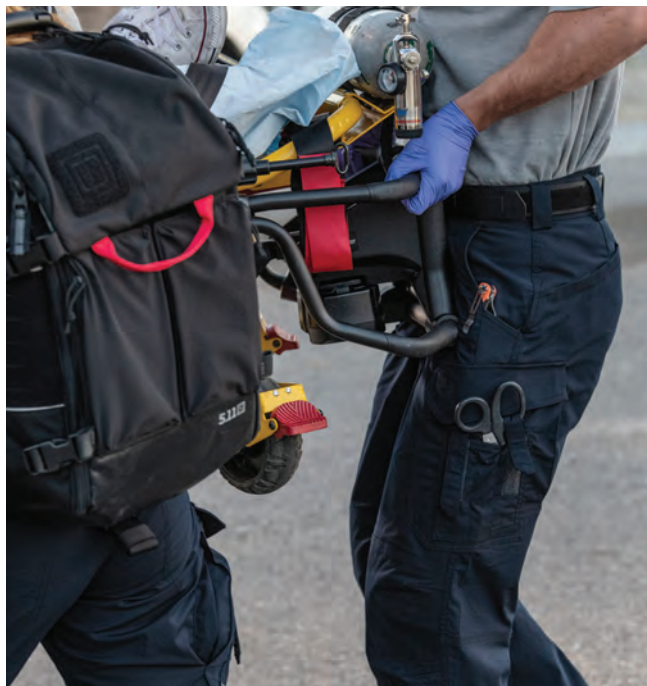

EMS PANTS 146



5.11 STRYKE® TDU 138
 Tactical Duty Uniforms 142



STATION WEAR 148



Flex-Tac® Poly/Wool Highlights:

- + Wool absorbs moisture vapor and controls odor naturally
- + Home laundry and dry clean friendly
- + Fabric development supported by The Woolmark Company®
- + Twill weave provides classic fabric finish and feel
- + Wool resists abrasion, retains its shape and color
- + Wool provides natural thermo-regulation and UV protection
- + Fine Australian Merino wool for next to skin softness



CLASS A FLEX-TAC POLY/WOOL SHIRTS REGULAR FIT



Made with 5.1-oz., Flex-Tac® 62% polyester / 38% fine Australian Merino Wool twill with mechanical stretch fabric with a Teflon™ finish. Men's and women's shirts feature traditional patch pockets with scalloped pocket flaps (with pen guides) and YKK® zippered center front closure. A kit with epaulettes, badge tab, camera/radio loop, name badge support strip and microphone bag are included in a separate bag. Imported.

STRETCH



Front zipper placket.



Radio wire routing.



Teflon™ finish.

CLASS A FLEX-TAC POLY/WOOL PANTS STRAIGHT FIT



Made 7.8-oz., Flex-Tac® 60% polyester / 40% fine Australian Merino Wool twill with mechanical stretch fabric with a Teflon™ finish. Men's and women's pants feature a clean traditional Class A silhouette with permanent creases, two hip pockets, double welted rear pockets and a hidden utility pocket at the right front waistband. The pants are made with our tunnel waistband and gripper elastic to help keep your uniform shirt tucked in for a neat, clean and professional appearance. Imported.

STRETCH



Padded waistband with gripper elastic.



Self-adjusting tunnel waistband.



Teflon™ finish.

CLASS A FLEX-TAC™ POLY/WOOL SHIRTS

71381	Men's	Class A Shirt	Flex-Tac Poly/Wool	Short Sleeve	S-6XL	Short/Regular/Tall	019, 160, 750
72487	Men's	Class A Shirt	Flex-Tac Poly/Wool	Long Sleeve	S-6XL	Short/Regular/Tall	019, 160, 750
71393	Men's	Class A Rapid Shirt	Flex-Tac Poly/Wool	Short Sleeve	S-6XL	Regular/Tall	019, 160, 750
72520	Men's	Class A Rapid Shirt	Flex-Tac Poly/Wool	Long Sleeve	S-6XL	Regular/Tall	019, 160, 750
61315	Women's	Class A Shirt	Flex-Tac Poly/Wool	Short Sleeve	XS-XL	Regular/Tall	019, 160, 750
62393	Women's	Class A Shirt	Flex-Tac Poly/Wool	Long Sleeve	XS-XL	Regular/Tall	019, 160, 750

Men's Short: 5'3"-5' 7 1/2", Regular: 5'8"-6' 1/2", Tall: 6'1"-6'3". Women's Talls in select sizes and colors. Regular: 5'5"-5'7", Tall: 5'8"-5'11"

CLASS A FLEX-TAC™ POLY/WOOL PANTS

74492	Men's	Class A Pant	Flex-Tac Poly/Wool	30"-60" even waist sizes, unhemmed	019, 160, 750, 890
74507	Men's	Class A Cargo Pant	Flex-Tac Poly/Wool	30"-60" even waist sizes, unhemmed	019, 160, 750, 890
64424	Women's	Class A Pant	Flex-Tac Poly/Wool	2-20 even sizes, unhemmed	019, 160, 750, 890
64432	Women's	Class A Cargo Pant	Flex-Tac Poly/Wool	2-20 even sizes, unhemmed	019, 160, 750, 890

Men's unhemmed length is 39-1/2", Women's unhemmed length is 37-1/2"

BLACK 019

SILVER TAN 160

MIDNIGHT NAVY 750

SHERIFF GREEN 890

5.11 STRYKE® PDU

- + Class A and Class B uniforms for men and women
- + Flex-Tac® mechanical stretch performance fabric

- + Teflon™ finish for stain and soil resistance
- + Easy to wear with a purely professional appearance



5.11 STRYKE® PDU® PANT STRAIGHT FIT

The Stryke PDU Pant (available in Class A or Class B) combines a sharp, professional appearance with all-day comfort and high-performance functionality. Constructed from our Flex-Tac® mechanical stretch fabric, featuring reinforced bartacking, Teflon™ finish for stain and soil resistance, and sturdy melamine buttons, these pants will endure. Traditional hip pockets, double welt-back pockets, a built-in flashlight pocket (Class B only) and low-profile cargo pocket (Class B) give you

smart storage. Permanent creases, a self-adjusting tunnel waistband, and an internal gripper panel keep you comfortable, neat, clean, and professional. UPF 50. Imported.

- + 6.8-oz., 80% polyester / 20% cotton Flex-Tac® mechanical stretch ripstop with Teflon™ finish.



5.11 STRYKE PDU PANTS

74426	Men's	Class A Pant	Flex-Tac	Hidden zip-side thigh pocket	30, 31, 32, 33, 34, 35, 36-60 even sizes, unhemmed.	019, 750
74427	Men's	Class B Pant	Flex-Tac	Low Profile Cargo Pocket	30, 31, 32, 33, 34, 35, 36-60 even sizes, unhemmed.	019, 750
64400	Women's	Class A Pant	Flex-Tac	Hidden zip-side thigh pocket	2-20 even sizes, unhemmed.	019, 750
64402	Women's	Class B Pant	Flex-Tac	Low Profile Cargo Pocket	2-20 even sizes, unhemmed.	019, 750
46-60" waist, unhemmed		Men's unhemmed length is 39-1/2", Women's unhemmed length is 37-1/2"				

BLACK 019

MIDNIGHT NAVY 750



5.11 STRYKE® PDU SHIRT REGULAR FIT

5.11's Stryke PDU Shirt (available in Class A or Class B) delivers comfort, durability, and high-performance utility in any field environment. Crafted from 4.8-oz., 78% polyester / 22% cotton Flex-Tac® mechanical stretch fabric, featuring triple-needle stitching, bartacking at key seams and stress points, a Teflon™ finish for stain and soil resistance, and sturdy melamine buttons, this shirt is built to last. It's also built to work. The Stryke PDU Shirt includes a camera/radio loop, pass-through wire access, a badge tab, and epaulettes. Imported.



Class B features our patented ReadyPocket™ on the left and right chest.

STRETCH READY POCKET™



5.11 STRYKE® PDU RAPID SHIRT FITTED

When responsiveness, readiness, range of motion, and tactical utility have to be at equally high levels, the 5.11 Stryke® Rapid Shirt checks all the boxes. It features dual-fabric construction with two types of finishes: Teflon™ and wicking/odor-control, for optimal comfort and protection. So bring on the sprints, the sweat, and the stress, the high-tech 5.11 Stryke® Rapid, complete with permanently stitched creases, keeps your clean, professional look intact. Imported.

+ Upper body is 4.8-oz., 78% polyester / 22% cotton Flex-Tac® mechanical stretch ripstop fabric with a Teflon™ finish for stain and oil resistance

+ Lower body is 4.5-oz., 100% polyester jersey with a moisture wicking and odor-control finish

STRETCH

5.11 STRYKE PDU SHIRTS

72073	Men's	Class A Shirt	Flex-Tac	Long Sleeve	S-6XL*	Short/Regular/Tall**	019, 750
72074	Men's	Class B Shirt	Flex-Tac	Long Sleeve	S-6XL*	Short/Regular/Tall**	019, 750
71037	Men's	Class A Shirt	Flex-Tac	Short Sleeve	S-6XL*	Short/Regular/Tall**	019, 750
71038	Men's	Class B Shirt	Flex-Tac	Short Sleeve	S-6XL*	Short/Regular/Tall**	019, 750
72519	Men's	Rapid Shirt	Flex-Tac	Long-Sleeve	S-6XL*	Short/Regular/Tall**	019, 750
71392	Men's	Rapid Shirt	Flex-Tac	Short-Sleeve	S-6XL*	Short/Regular/Tall**	019, 750
62008	Women's	Class A Shirt	Flex-Tac	Long Sleeve	XS-XL	Regular/Tall**	019, 750
62010	Women's	Class B Shirt	Flex-Tac	Long Sleeve	XS-XL	Regular/Tall**	019, 750
61016	Women's	Class A Shirt	Flex-Tac	Short Sleeve	XS-XL	Regular/Tall**	019, 750
61018	Women's	Class B Shirt	Flex-Tac	Short Sleeve	XS-XL	Regular/Tall**	019, 750

* Sizes 3XL+ add

** Shorts and Talls in select sizes and colors. Men's Short: 5'3"-5' 7 1/2", Regular: 5'8"-6' 1/2", Tall: 6'1"-6'3". Womens Regular: 5'5"-5'7", Tall: 5'8"-5'11"

BLACK 019

MIDNIGHT NAVY 750

NYPD 5.11 STRYKE® PANT STRAIGHT FIT

The 5.11 Stryke® pant, redesigned for NYPD uniform approved wear. With the same fit and functionality you expect from 5.11 Tactical, the new NYPD Stryke pant features ergonomic rear welt pockets sized to carry the large NYPD Memo Book.

- + Teflon™ treated for soil and stain resistance
- + Ultra fade-, shrink-, and wrinkle-resistant, home laundry friendly
- + 7 belt loops, men's pants feature self-adjusting tunnel waistband, women's pants feature stretch side panels
- + Slanted ergonomic cargo pockets have bellows at center and large flaps with hook & loop closure
- + Slanted ergonomic welt pockets at back have button closure and are extra big to fit large NYPD memo book
- + Badge holders on front belt loops
- + Diamond shaped gusseted construction
- + Double knee with knee pad access (knee pads sold separately)



 STRETCH



Twill - 7.3-oz., 81% polyester / 19% cotton, mechanical stretch Flex-Tac® PDU Twill (patent pending) with Teflon™ finish.



Ripstop - 6.8-oz., 80% polyester / 20% cotton, mechanical stretch patented Flex-Tac® Ripstop with Teflon™ finish.



NYPD 5.11 STRYKE® PDU PANTS

74484	Men's	NYPD 5.11 Stryke Pant	Flex-Tac Twill	Rear welt pockets sized to carry the NYPD Memo Book	28-44 even sizes with 30-36 even inseams, 46-54 even sizes (74484L) with an unhemmed length	762 NYPD NAVY
74485	Men's	NYPD 5.11 Stryke Pant	Flex-Tac Ripstop	Rear welt pockets sized to carry the NYPD Memo Book	28-44 even sizes with 30-36 even inseams, 46-54 even sizes (74485L) with an unhemmed length	762 NYPD NAVY
64421	Women's	NYPD 5.11 Stryke Pant	Flex-Tac Twill	Rear welt pockets sized to carry the NYPD Memo Book	0-20 even sizes, regular or long inseams	762 NYPD NAVY
64422	Women's	NYPD 5.11 Stryke Pant	Flex-Tac Ripstop	Rear welt pockets sized to carry the NYPD Memo Book	0-20 even sizes, regular or long inseams	762 NYPD NAVY

46-54" waist, unhemmed Men's unhemmed length is 39-1/2", Women's regular inseam is 32", long inseam is 35"

NYPD NAVY 762

CLASS A FAST-TAC® TWILL UNIFORMS

- + Professional-grade uniform at a value-driven price
- + Fast-Tac® fabric with outstanding durability

- + 100% polyester with a durable water repellent finish
- + Lightweight and fade-resistant fabric



CLASS A FAST-TAC® TWILL SHIRTS

REGULAR FIT

The lightweight, water-resistant Class A Fast-Tac® Twill is equipped for duty, with mic loop openings on the side seams, dual chest pockets with pen guides, and a center front zip closure. It also comes with everything you need to do your job: Epaulettes, badge tab, camera/radio loop, and a name badge support strip. The stitched creases help you maintain a professional look, no matter what your time at the station or on the street entails. Imported.

- + Zip closure at center front
- + Microphone loop openings on side seams
- + Epaulettes, badge tab, camera/radio loop, name strip (included)
- + 5.1-oz., 100% polyester twill with a durable water repellent finish



CLASS A FAST-TAC® TWILL PANTS

STRAIGHT FIT

It may be your everyday uniform, but you don't often do everyday things. Which is why the 5.11 Class A Fast-Tac® Twill Pant is made to help you maintain peak levels of comfort and professionalism. It has a tunnel waistband with gripper elastic to keep your shirt tucked in, a diamond gusset for stronger seams, and permanent creases. This pant even has a durable water-repellent finish to make the rain, or a coffee or water spill, roll right off. Imported.

- + Tunnel waistband
- + Gripper elastic inside waistband to keep shirt tucked in
- + Diamond gusset for seam strength
- + 6.1-oz., 100% polyester twill with a durable water repellent finish

CLASS A FAST-TAC TWILL SHIRTS

72510	Men's	Class A Shirt	Fast-Tac Twill	Long Sleeve	S-6XL*	Short/Regular/Tall	019, 750, 992
71384	Men's	Class A Shirt	Fast-Tac Twill	Short Sleeve	S-6XL*	Short/Regular/Tall	019, 750, 992
62396	Women's	Class A Shirt	Fast-Tac Twill	Long Sleeve	XS-XL	Regular/Tall	019, 750, 992
61318	Women's	Class A Shirt	Fast-Tac Twill	Short Sleeve	XS-XL	Regular/Tall	019, 750, 992

* Sizes 3XL+ and Tall sizes add Short: 5'3"-5' 7 1/2", Regular: 5'8"-6' 1/2", Tall: 6'1"-6'3".

CLASS A FAST-TAC TWILL PANTS

74523	Men's	Class A Pant	Fast-Tac Twill	30- 60 even waist sizes, unhemmed.	019, 750
64443	Women's	Class A Pant	Fast-Tac Twill	2-20 even sizes, unhemmed.	019, 750

46-60" waist. Men's unhemmed length is 39-1/2", Women's unhemmed length is 37-1/2".

BLACK 019

MIDNIGHT NAVY 750

UNIFORM WHITE 992

MOUNTED PATROL



MOTORCYCLE BREECHES SLIM FIT



They're built from a high-performance, low-drag 10.3-oz., 66% polyester / 34% cotton cavalry-stretch twill. They're treated with a Teflon[®] finish for stain and soil resistance, and feature double thick fabric at the seat, inner-knee, and calf for added chafe-protection. Clearly, 5.11's Motorcycle Breeches are engineered to stand up to the punishing duties of mounted patrol. Add a self-adjusting tunnel waistband, double-articulated knees for enhanced responsiveness, and these pants are good to ride. Side-zip vents and on-seam pockets will have you cool and ready for duty. UPF 50. Imported.

 STRETCH

74407 Motorcycle Breeches | Black 019, Silver Tan 160, Midnight Navy 750 | 750 | 28-50 evens, 25" (63 cm) short, 27" (69 cm) regular, 29" (74 cm) long inseams |



Rear thigh baton pocket.



Zippered pant cuffs.

BLACK 019

SILVER TAN 160

MIDNIGHT NAVY 750





BIKE PATROL ZIP-OFF PANT RELAXED FIT

Purpose-built for bicycle patrol officers, the Bike Patrol Zip-Off Pant features lightweight, quick-drying 3.7-oz., 94% nylon / 6% elastane plain weave stretch fabric. The legs zip off for an easy conversion to shorts with a 9" inseam. While a nonslip elastic waistband, adjustable belt loops, a gusseted construction, and articulated knees assure you a professional appearance and superior mobility. Imported.

 STRETCH

45502 Bike Patrol Zip-Off Pant | Black 019, Dark Navy 724 | 28-44 even sizes 30-36 even inseams |



Zippered pant cuffs.



Pant legs zip off above the knee.



Pants convert to a 9" inseam short.

BLACK 019

DARK NAVY 724



PATROL SHORT

Tough, lightweight, and functional, the Patrol Short is built from a specialized blend of high-performance fabric built for the demands of bike patrol officers. 3.7-oz., 94% nylon / 6% elastane plain weave stretch fabric., with a non-slip elastic waistband, running crotch gusset, and hook-and-loop adjustable belt-keepers, these shorts are perfect for high-performance public safety professionals. Zip-closure rear pockets and compartmentalized cargo pockets provide smart storage. UPF 50. Imported.

 STRETCH

43057 Patrol Short (9" Inseam) | Black 019, Dark Navy 724 | 28-44 even sizes |

BLACK 019

DARK NAVY 724



5.11 S.A.F.E.™ BADGES

S.A.F.E.™ badges are a lightweight and flexible badge solution that appears to be metallic, providing a traditional look of authority superior to embroidery that is laundry-safe, easier to care for than metal badges and protected against unauthorized duplication. Through 5.11's S.A.F.E.™ technology, we can offer a custom badge solution for your department.

- + Home laundry and dry cleaner friendly
- + Will outlast the garment they are applied to
- + Template based and full customization options available

IMAGE:	S.A.F.E.™	METAL	EMBROIDERY
Realistic	Yes	Limited	No
High Resolution	Yes	No	No
Authoritative	Yes	Yes	No
High Perceived Value	Yes	Yes	Medium
3-Dimensional	Yes	Yes	Limited
Faithful Color Reproduction	Yes	Limited	Limited
FEEL:	S.A.F.E.™	METAL	EMBROIDERY
Comfortable	Yes	No	Maybe
No Irritation Inside Garment	Yes	No	No
Supple	Yes	No	Limited
Flexible	Yes	No	Yes
Conforming to Garment	Yes	No	Limited
Dimensional	Yes	Yes	Limited
Lightweight	Yes	No	Limited
Lies Flat, No Puckering	Yes	No	Limited
FUNCTIONS:	S.A.F.E.™	METAL	EMBROIDERY
Permanent	Yes	Yes	Yes
Fast Application	Yes	N/A	No
Works Well on Sheer Textiles	Yes	No	No
Difficult to Make Copies	Yes	No	No



PATROL DUTY UNIFORMS



READY POCKET™
(CLASS B ONLY)

BADGE TAB &
EPAULETTES

ZIPPERED
PLACKET

SEWN-IN
CREASES

LOW-PROFILE
CARGO POCKET
(CLASS B ONLY)

PERMANENT
CREASES



TEFLON™
FINISH



PATROL DUTY UNIFORMS

- + Extensive size and color range for men and women
- + Class A, Class B and Rapid profiles

- + Polyester/cotton twill or Taclite® ripstop fabric
- + Outstanding fade resistance and lasting durability

PATROL DUTY UNIFORM® PANTS

STRAIGHT FIT



PDU® pants are available in twill or Taclite® ripstop and finished with Teflon™ for stain- and soil-resistance. PDU pants feature a self-adjusting comfort waistband with an extra-wide gripper that cushions your duty belt and helps keep your shirt tucked in. Imported.

- + Twill pants: 7.5-oz., 65% polyester / 35% cotton twill
- + Ripstop pants: 6.3-oz., 65% polyester / 35% cotton Taclite ripstop

PATROL DUTY UNIFORM® SHIRTS

REGULAR FIT

FITTED



All PDU® shirts are made from 65% polyester/35% cotton in an 5.8-oz. twill or 4.4-oz. Taclite® ripstop and feature a Teflon™ finish for stain- and soil- resistance. PDU shirts come with epaulettes, badge tabs, and a front zippered placket. PDU shirts also include armpit vents, a mic-cord pass-through, and adjustable cuffs. Class B shirts feature our patented Ready Pocket™. PDU Rapid shirts are built with a knit, moisture-wicking body for comfort when worn under outer armor carriers. Imported.

MEN'S PDU SHIRTS						
71183	Class A Shirt	PDU Twill	Short-Sleeve	S-6XL*	Short/Regular/Tall**	010, 019, 160, 750
72344	Class A Shirt	PDU Twill	Long-Sleeve	S-6XL*	Short/Regular/Tall**	010, 019, 160, 750
71177	Class B Shirt	PDU Twill	Short-Sleeve	S-6XL*	Short/Regular/Tall**	010, 019, 160, 750
72345	Class B Shirt	PDU Twill	Long-Sleeve	S-6XL*	Short/Regular/Tall**	010, 019, 160, 750
71167	Class A Shirt	Taclite Ripstop	Short-Sleeve	S-6XL*	Short/Regular/Tall**	108, 750, 850
72365	Class A Shirt	Taclite Ripstop	Long-Sleeve	S-6XL*	Short/Regular/Tall**	108, 750, 850
71168	Class B Shirt	Taclite Ripstop	Short-Sleeve	S-6XL*	Short/Regular/Tall**	724, 750
72366	Class B Shirt	Taclite Ripstop	Long-Sleeve	S-6XL*	Short/Regular/Tall**	724, 750
71332	PDU Rapid Shirt	Twill/Knit	Short-Sleeve	S-6XL*	Short/Regular/Tall**	019, 160, 750
72197	PDU Rapid Shirt	Twill/Knit	Long-Sleeve	S-6XL*	Short/Regular/Tall**	019, 160, 750
71046	Taclite PDU Rapid Shirt	Taclite/Knit	Short-Sleeve	XS-6XL*	Short/Regular/Tall**	750
72093	Taclite PDU Rapid Shirt	Taclite/Knit	Long-Sleeve	XS-6XL*	Short/Regular/Tall**	750
50087	Taclite Epaulette Kit	Taclite/Knit				019, 190, 724

* Sizes 3XL+ and Tall sizes add (PDU Rapid add) ** Shorts and Talls in select sizes and colors. Short: 5'3"-5' 7 1/2", Regular: 5'8"-6' 1/2", Tall: 6'1"-6'3".

WOMEN'S PDU SHIRTS						
61158	Class A Shirt	PDU Twill	Short-Sleeve	Missy Fit XS-XL*	Regular/Tall**	010, 019, 160, 750
62064	Class A Shirt	PDU Twill	Long-Sleeve	Missy Fit XS-XL*	Regular/Tall**	010, 019, 160, 750
61159	Class B Shirt	PDU Twill	Short-Sleeve	Missy Fit XS-XL*	Regular/Tall**	160, 750
62065	Class B Shirt	PDU Twill	Long-Sleeve	Missy Fit XS-XL*	Regular/Tall**	019, 160, 750
61167	Class A Shirt	Taclite Ripstop	Short-Sleeve	Missy Fit XS-XL	Regular/Tall**	108, 750, 850
62365	Class A Shirt	Taclite Ripstop	Long-Sleeve	Missy Fit XS-XL	Regular/Tall**	108, 750, 850
61168	Class B Shirt	Taclite Ripstop	Short-Sleeve	Missy Fit XS-XL	Regular/Tall**	750
62366	Class B Shirt	Taclite Ripstop	Long-Sleeve	Missy Fit XS-XL	Regular/Tall**	750
61304	PDU Rapid Shirt	Twill/Knit	Short-Sleeve	XS-XL	Regular/Tall**	019, 160, 750
62372	PDU Rapid Shirt	Twill/Knit	Long-Sleeve	XS-XL	Regular/Tall**	019, 160, 750

** Talls available in select sizes and colors. Regular 5'5-5'7, Tall 5'8-5'11

MEN'S PDU PANTS						
74338	Class A Pant	PDU Twill	Hidden zip-side thigh pocket	30, 31, 32, 33, 34, 35, 36-60 even sizes*, unhemmed		019, 750, 890
74326	Class B Pant	PDU Twill	Low Profile Cargo Pocket	30, 31, 32, 33, 34, 35, 36-60 even sizes*, unhemmed		019, 108, 750, 890
74370	Class A Pant	Taclite Ripstop	Hidden side-zip thigh pocket	30, 31, 32, 33, 34, 35, 36-60 even sizes*, unhemmed		108, 724, 750
74371	Class B Pant	Taclite Ripstop	Low Profile Cargo Pocket	30, 31, 32, 33, 34, 35, 36-60 even sizes*, unhemmed		108, 750, 850

* Sizes 46+ add Men's unhemmed length is 39-1/2"

WOMEN'S PDU PANTS						
64304	Class A Pant	PDU Twill	Hidden zip-side thigh pocket	Missy Fit 2-20 evens unhemmed		019, 750, 890
64308W	Class A Pant	PDU Twill	Hidden side-zip thigh pocket	Women's Fit 16W-28W evens unhemmed		750
64306	Class B Pant	PDU Twill	Low Profile Cargo Pocket	Missy Fit 2-20 evens unhemmed		019, 750, 890
64310W	Class B Pant	PDU Twill	Low Profile Cargo Pocket	Women's Fit 16W-28W evens unhemmed		750
64370	Class A Pant	Taclite Ripstop	Hidden side-zip thigh pocket	Missy Fit 2-20 evens unhemmed		108, 750
64371	Class B Pant	Taclite Ripstop	Low Profile Cargo Pocket	Missy Fit 2-20 evens unhemmed		108, 750, 850
64387	Go Pant	PDU Twill	Zippered Drop Tail	2-20 unhemmed		750

Women's unhemmed length is 37-1/2".

WHITE 010	BLACK 019	BROWN 108	SILVER TAN 160
DARK NAVY 724	MIDNIGHT NAVY 750	SPRUCE 850	SHERIFF GREEN 890



UNIFORM OUTER CARRIERS

The perfect companion for our PDU® and 5.11 Stryke® PDU® Rapid shirts, our new Uniform Outer Carriers support a wide range of third-party soft body armor panels and are available in Class A and Class B profiles in an expanded range of sizes.

Uniform Outer Carriers are made with fade-resistant 7.4-oz. 100% polyester twill and are finished with Teflon™ for stain- and soil-resistance and feature sewn-in creases in front and back. Front chest patch pockets feature pen slots. Class B styles add 5.11's Ready Pockets at the left and right chest. Imported.

- + Elastic cummerbund for comfort and a secure fit
- + Embellishment kit (epaulette, badge tab, radio loop and badge support strap included)
- + User guide included



Class B features our patented ReadyPocket™ on the left and right chest.



UNIFORM OUTER CARRIERS

49032	Men's Class A Uniform Outer Carrier	XS, XS/S, S, S/M, M	Short, Regular	019, 160, 750
		M/L, L, L/XL, XL, 2XL	Regular	
49032T	Men's Class A Tall Uniform Outer Carrier	S/M, M, M/L, L, L/XL, XL, 2XL, 3XL, 4XL, 5XL	Tall	019, 160, 750
		M/L, L, L/XL, XL, 2XL, 3XL, 4XL, 5XL	Extra Tall	
49030	Men's Class B Uniform Outer Carrier	XS, XS/S, S, S/M, M	Short, Regular	019, 160, 750
		M/L, L, L/XL, XL, 2XL	Regular	
49030T	Men's Class B Tall Uniform Outer Carrier	S/M, M, M/L, L, L/XL, XL, 2XL, 3XL, 4XL, 5XL	Tall	019, 160, 750
		M/L, L, L/XL, XL, 2XL, 3XL, 4XL, 5XL	Extra Tall	
49033	Women's Class A Uniform Outer Carrier	XS, XS/S, S, S/M, M	Short, Regular	019, 160, 750
		M/L, L, L/XL, XL	Regular	
49031	Women's Class B Uniform Outer Carrier	XS, XS/S, S, S/M, M	Short, Regular	019, 160, 750
		M/L, L, L/XL, XL	Regular	

BLACK 019

SILVER TAN 160

MIDNIGHT NAVY 750



HEXGRID® UNIFORM OUTER CARRIERS

The HEXGRID Uniform Outer Carrier provides a versatile, customizable platform for attaching MOLLE or web pouches, and supports a wide range of third-party soft body armor panels. Front panels feature 5.11's own HEXGRID system, with the body of the carrier constructed in our fade-resistant 7.2-oz., 100% nylon canvas with reinforced zones for durability. The elastic cummerbund promotes comfort and a secure fit. A Teflon® finish resists the inevitable stains and soiling that comes with a day in your boots. In addition to regular fit, this carrier is available in an expanded range of sizes for men and women. Imported.



- + Loop patch panel at upper front and back
- + User guide included
- + Body: 7.2-oz., 100% nylon plain weave with a Teflon® finish
- + HEXGRID®: 19.2-oz., 100% nylon Cordura® plain weave, TPU, water-resistant finish

HEXGRID UNIFORM OUTER CARRIERS

49036	Men's HEXGRID Uniform Outer Carrier	XS, XS/S, S, S/M, M	Short, Regular	019, 328, 724
		M/L, L, L/XL, XL, 2XL	Regular	
49036T	Men's HEXGRID Tall Uniform Outer Carrier	S/M, M, M/L, L, L/XL, XL, 2XL, 3XL, 4XL, 5XL	Tall	019, 328, 724
		M/L, L, L/XL, XL, 2XL, 3XL, 4XL, 5XL	Extra Tall	
		XS, XS/S, S, S/M, M	Short, Regular	
49037	Women's HEXGRID Uniform Outer Carrier	M/L, L, L/XL, XL	Regular	019, 328, 724

BLACK 019

SANDSTONE 328

DARK NAVY 724

XPRT[®] UNIFORMS





XPRT® TACTICAL SHIRT REGULAR FIT



- + Ergonomically fitted retracting bi-swing shoulders
- + Main body is constructed of 4.2-oz., 60% cotton / 40% Cordura® NYCO Tactical Nylon ripstop with Teflon™ finish, gussets are 5.0-oz., 60% cotton / 40% Cordura® jersey with wicking and odor-control finish
- + DuPont Kevlar® interlock fabric built into mandarin collar
- + Ortholite® shoulder pads with a textured surface for air flow
- + Elbow features a bonded layer for enhanced abrasion resistance
- + Articulated elbowpad pockets accommodate internal soft elbowpads and select hard elbowpads
- + 7 pockets including low profile front utility chest pockets with internal bellows, zippered bicep pockets, pen pockets on left forearm and small utility pocket on right forearm
- + Adjustable sleeve cuffs and collar closure
- + Tether loops inside utility pockets and bicep pockets
- + Includes loop shoulder patches, badge tab, epaulettes and camera loop

STRETCH READY POCKET™

XPRT® TACTICAL PANT RELAXED FIT



- + Main body is constructed of 6.2-oz., 60% cotton / 40% Cordura® NYCO Tactical Nylon ripstop with Teflon™ finish, gusset and yoke are 4.7-oz., 87% polyester / 13% elastane plain weave with DWR finish
- + Low-profile adjustable waistband system with a sculpted waistband has spacer mesh for comfort and breathability
- + Abrasion resistant stretch riding gusset with DuPont Kevlar® lining
- + Articulated kneepad pockets accommodate internal soft kneepads and select hard kneepads
- + Includes 5.11's ENDO.K internal kneepads with D30® technology for high performance shock absorption
- + 16 pockets in total, including front hand pockets with Nylon 6 reinforced edges
- + Cargo, rear and lower leg pockets feature magnetic closures for quiet access
- + Hidden cuff key pockets and nylon blousing strap capable of cutting flex-cuffs with friction
- + Knees and seat feature a bonded layer for enhanced abrasion resistance

STRETCH



XPRT® RAPID SHIRT REGULAR FIT



- + Upper body is constructed of 4.2-oz., 60% cotton / 40% Cordura® NYCO Tactical Nylon with Teflon™ finish, lower body is 5-oz., 60% cotton / 40% Cordura® jersey with wicking and odor-control finish
- + Ergonomically fitted design with knit body and arm gussets for outstanding comfort
- + DuPont Kevlar® interlock fabric built into mandarin collar
- + Ortholite® shoulder pads with a textured surface for air flow
- + Elbow features a bonded layer for enhanced abrasion resistance
- + Articulated elbowpad pockets accommodate internal soft elbowpads and select hard elbowpads
- + 5 pockets including zippered bicep pockets, pen pockets on left forearm and small utility pocket on right forearm
- + Elastic tether loops inside upper bicep pockets
- + Adjustable sleeve cuffs
- + Includes loop shoulder patches, badge tab and epaulettes

STRETCH

XPRT® TACTICAL SHIRTS

72091	Men's	XPRT Tactical Shirt	S-3XL	019, 162, 190, 724
72095	Men's	XPRT Tactical Multicam Shirt	S-3XL	169
72090	Men's	XPRT Rapid Shirt	S-3XL	019, 162, 190, 724
72094	Men's	XPRT Rapid Multicam Shirt	S-3XL	169
62024	Women's	XPRT Tactical Shirt	XS-XL	019, 162, 190, 724
62023	Women's	XPRT Rapid Shirt	XS-XL	019, 162, 190, 724

XPRT® TACTICAL PANT

74068	Men's	XPRT Tactical Pant	30-44 even sizes, 30-34 even inseams	019, 162, 190, 724
74070	Men's	XPRT Tactical MultiCam® Pant	30-44 even sizes, 30-34 even inseams	169
64414	Women's	XPRT Tactical Pant	2-20 even sizes, reg (32") or long (35")	019, 162, 190, 724

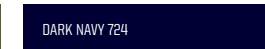
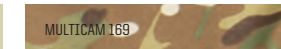
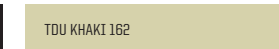

5.11 STRYKE[®] TDU



5.11 STRYKE® TDU® SHIRTS



The 5.11 Stryke TDU Shirt offers unparalleled maneuverability, durability, and utility in any demanding environment. The shirt is built from our Flex-Tac® mechanical stretch fabric and features reinforced, articulated elbows with a Teflon™ finish for stain and soil resistance. Adjustable cuffs, a mandarin collar, and a full-zip front ensure a secure fit; and a badge tab, loop patch platform, and epaulettes allow complete uniform integration. With canted chest pockets, vertical sleeve pockets, and forearm pen pockets. Also available in our Rapid Assault style with moisture-wicking knit body. Imported.



STRETCH READY POCKET™

- + TDU Shirts: 7.8-oz., 78% polyester / 22% cotton Flex-Tac® mechanical stretch ripstop with Teflon™ finish
- + TDU Rapid Shirts: 7.8-oz., 78% polyester / 22% cotton Flex-Tac® mechanical stretch ripstop with Teflon™ finish upper body with 5.3-oz., 87% polyester / 13% elastane jersey knit with moisture wicking and odor-control

5.11 STRYKE® TDU® PANT

STRAIGHT FIT



5.11's Stryke TDU Pant provides the high-performance maneuverability, durability, and utility required in high-activity, tactical environments. Built from our Flex-Tac® mechanical stretch fabric featuring bartacked construction finish, the 5.11 Stryke TDU Pant is built for hard use. With double-layered, articulated knees, a fully-gusseted crotch, and stretch panels at the waist and knees, you'll have a secure and flexible fit even when you're on the move. Ergonomic cargo pockets, hip pockets, and knee pockets for available 5.11 kneepads keep you squared away. It's time to roll. Imported.

STRETCH

- + 6.8-oz., 80% polyester / 20% cotton Flex-Tac® mechanical stretch ripstop with Teflon™ finish



5.11 STRYKE® TDU® SHIRTS

72416	Men's	5.11 Stryke TDU Shirt	Classic Fit	XS-3XL, L-5XL Tall (72416T)	019, 092, 162, 186, 190, 724
72480	Men's	5.11 Stryke TDU MultiCam® Shirt	Classic Fit	XS-3XL, L-5XL Tall (72480T)	169
72416G7	Men's	5.11 Stryke TDU GE07 Shirt	Classic Fit	S-3XL, L-5XL Tall (72416TG7)	357, 865
72071	Men's	5.11 Stryke TDU Rapid Shirt	Fitted	XS-3XL, L-5XL Tall (72071T)	019, 092, 162, 186, 190, 724
72481	Men's	5.11 Stryke TDU MultiCam® Rapid Shirt	Fitted	XS-3XL, L-5XL Tall (72481T)	169
72071G7	Men's	5.11 Stryke TDU GE07 Rapid Shirt	Fitted	S-3XL, L-5XL Tall (72071TG7)	357, 865

5.11 STRYKE® TDU® PANTS

74433	Men's	5.11 Stryke TDU Pant	28-44 even waist, 28-36 even inseams; 46-54 even waist, unhemmed	019, 092, 162, 186, 190, 724
74483	Men's	5.11 Stryke TDU MultiCam® Pant	28-44 even waist, 28-36 even inseams; 46-54 even waist, unhemmed	169
74433G7	Men's	5.11 Stryke TDU GE07 Pant	28-44 even waist, 28-36 even inseams; 46-54 even waist, unhemmed	357, 865



QUANTUM TDU



QUANTUM TDU® SHIRT REGULAR FIT



We took a page out of the 5.11 operator playbook and came up with the Quantum TDU® Shirt. It's made with the kind of fabric engineered for high-level performance, where the smallest detail can make a world of difference. We built the body with FlexLite ripstop fabric with Teflon™ to give you freedom of movement and protection from water, oil, grease and dirt. The shoulders are Fast-Tac® fabric for flexibility and the rear panel is abrasion-resistant jersey for stretch and next-to-skin comfort. Imported.

- + Ready Pocket™ at left and right chest
- + Main Fabric: 5.6-oz., FlexLite Ripstop 71% polyester / 29% cotton, Teflon™ finish
- + Contrast Fabric: 4.7-oz., Fast-Tac® Ripstop 100% polyester, DWR finish
- + Contrast Fabric: 4.5-oz., full dull yarn jersey, 100% polyester, moisture wicking and odor-control finish

STRETCH READY POCKET™



Zippered placket with hook and loop cover.



Hook and loop wrist closures.

QUANTUM TDU® PANT STRAIGHT FIT



Take one giant leap ahead in tactical style and essential functionality in the Quantum TDU® Pant. Constructed with three distinct stretch fabrics for maximum flexibility and durability, you may find yourself wearing this pant often, and for a lot of different purposes. It has 8 pockets to store your portable essentials, and the comfort waistband and stretch gusset construction promote ultimate ease of movement. The Quantum is also Kneepad Ready and comes with blousing straps. Imported.

- + Ergonomic cargo pockets
- + Comfort waistband
- + Main Fabric: 5.6-oz., FlexLite Ripstop 71% polyester / 29% cotton. Teflon™ finish.
- + Contrast Fabric: 4.7-oz., Fast-Tac® Ripstop 100% polyester, DWR finish,
- + Contrast Fabric: 4.5-oz., 4-way stretch fabric, 87% polyester / 13% elastane, DWR finish

STRETCH



Four-way stretch panels at strategic locations for maximum comfort, breathability and ease of movement.



Three purpose-built fabrics are used throughout the Quantum TDU uniforms.



QUANTUM TDU®

74504	Men's	Quantum TDU Pant	28-44 even waist, 28-36 even inseams; 46-54 even waist, 30-34 even inseams	019, 186, 724
72506	Men's	Quantum TDU Shirt	S-3XL, L-5XL Tall (72560T)	019, 186, 724

BLACK 019

RANGER GREEN 196

DARK NAVY 724

TACTICAL DUTY UNIFORMS







TDU® PANT RELAXED FIT

Available in twill, Taclite® and ripstop, 5.11's TDU® Pant is built for rugged, durable, and high-performance. With a self-adjusting tunnel waistband, double-reinforced seat and knees, triple stitching and robust

bartacking, these pants are made to last. And with a Teflon™ finish, roomy cargo pockets, secure rear pockets, hidden kneepad pockets, and secondary mag pockets, you'll be more than satisfied. Imported.

TDU PANTS						
74003	Men's	TDU Pant	Ripstop	XS-4XL (Short/Regular/Long)*		019, 108, 162, 190, 724
74350	Men's	MultiCam® TDU Pant	Ripstop	S-3XL (Short/Regular/Long)*		169
74280	Men's	TDU Pant	Taclite	XS-4XL (Short/Regular/Long)*		019, 092, 190, 724
74462	Men's	Fast-Tac TDU Pant	Fast-Tac® Ripstop	28-44 even waist, 30-36 even inseams; 46-54 even waist, unhemmed		019, 162, 190, 724
74462G7	Men's	Fast-Tac TDU GE07 Pant	Fast-Tac® Ripstop	28-44 even waist, 30-36 even inseams; 46-54 even waist, unhemmed		357, 865
64359	Women's	TDU Pant	Ripstop	2-20 (Regular/Long)**		019, 190
Sizes 3XL+ add (74350 add 46-54 even waist sizes (74462) *Short: 29-1/2", Regular 32-1/2", Long: 35-1/2". ** Regular: 30"-32", Long 34"-36"						



TDU[®] SHIRT

CLASSIC FIT



Available in a range of fabrics and colors, our TDU Shirt is an ideal choice for tactical duty use. Rugged and fade-resistant, Teflon[®] treated for stain- and soil-resistance, and featuring bi-swing shoulders, reinforced elbows, the shirt is as comfortable as it is tough. Patented 5.11 Ready Pocket[™] at left and right chest. Imported.

READY POCKET[™]



RAPID ASSAULT SHIRT

FITTED



The body of the Rapid Assault Shirt is built from moisture-wicking poly/cotton/spandex for durability, breathability, and stretch. The shoulders and sleeves are made of poly/cotton ripstop and feature angled sleeve pockets, just in case the shirt wasn't tough enough. With a zip-up collar, flat-lock seams for comfort, and saddle-shoulder design, you'll be ready for anything. Imported.

TDU SHIRTS

71339	Men's	TDU Shirt	Taclite Ripstop	Short-Sleeve	S-4XL, L-5XL Tall*	019, 092, 162, 190, 724
72054	Men's	TDU Shirt	Taclite Ripstop	Long-Sleeve	S-4XL, L-5XL Tall*	019, 092, 190, 724
72013	Men's	MultiCam [®] TDU Shirt	Ripstop	Long-Sleeve	S-4XL*	169
72002	Men's	TDU Shirt	Ripstop	Long-Sleeve	XS-4XL*	019, 162, 190, 724
72465	Men's	Fast-Tac [™] TDU Shirt	Fast-Tac [™] Ripstop	Long-Sleeve	S-3XL, L-5XL Tall*	019, 162, 190, 724
72465G7	Men's	Fast-Tac [™] TDU GEO7 Shirt	Fast-Tac [™] Ripstop	Long-Sleeve	S-3XL, L-5XL Tall*	357, 865
71379	Men's	Fast-Tac [™] TDU Shirt	Fast-Tac [™] Ripstop	Short-Sleeve	S-3XL, L-5XL Tall*	019, 162, 190, 724
72194	Men's	Rapid Assault Shirt	Taclite/Knit	Long-Sleeve	XS-3XL*	019, 092, 162, 190, 724
72185	Men's	Multicam [®] Rapid Assault Shirt	Ripstop	Long-Sleeve	S-3XL*	169
72488	Men's	Fast-Tac [™] TDU Rapid Shirt	Fast-Tac [™] Ripstop	Long-Sleeve	XS-3XL, L-5XL Tall*	019, 162, 190, 724
72488G7	Men's	Fast-Tac [™] TDU GEO7 Rapid Shirt	Fast-Tac [™] Ripstop	Long-Sleeve	XS-3XL, L-5XL Tall*	357, 865
61025	Women's	TDU Shirt	Taclite Ripstop	Short-Sleeve	S-XL	019, 162, 724
62016	Women's	TDU Shirt	Taclite Ripstop	Long-Sleeve	S-XL	019, 162, 724

* Sizes 3XL+ add (72013 add 72194 add 72185 add Talls add Shorts and Talls in select sizes and colors. Short: 5'3"-5' 7 1/2", Regular: 5'8"-6' 1/2", Tall: 6'1"-6'3".

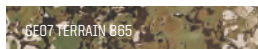
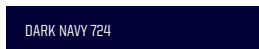
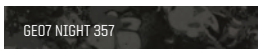
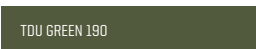
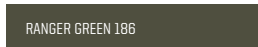
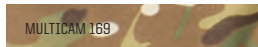
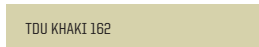

EMS PANTS





5.11 STRYKE® EMS PANT

RELAXED FIT



Constructed with our mechanical stretch 80% polyester / 20% cotton Flex-Tac® ripstop fabric with a Teflon™ finish for stain and soil resistance. The 5.11 Stryke EMS Pant raises the bar for functionality and comfort. A gusseted construction frees you up to move through the most challenging situations. But don't worry, the comfort waistband with stretch panels are not only flexible; it's set high in the back to help you maintain a professional appearance. Every pocket has a purpose, including the mission-specific, thigh-mounted cargo pockets with internal compartments, outer pockets with retention straps and welted rear pockets. Double layered knees are compatible with our D30® ENDO-K kneepads. Imported.



EMS PANT & EMS SHORT

RELAXED FIT



Our popular EMS Pant and Short are engineered with features, comfort, and performance you won't find anywhere else. Available in a 7.3-oz. twill or 6.2-oz. Taclite® ripstop (65% polyester / 35% cotton) with Teflon™ finish for stain and soil resistance, the EMS Pant and Short feature compartmentalized cargo pockets, secondary cargo pockets at the calf, and double-time belt loops for enhanced accessory anchorage. The reinforced knees accept kneepads, and a self-adjusting waist and gusseted construction ensure comfort and mobility. Imported.



The Taclite® EMS Short features an 11" inseam.

5.11 STRYKE® EMS PANTS

74482	Men's	5.11 Stryke® EMS Pant	Flex-Tac® mechanical stretch ripstop	28-44 even waist, 30-36 even inseams; 46-54 even waist, unhemmed	019, 724
64418	Women's	5.11 Stryke® EMS Pant	Flex-Tac® mechanical stretch ripstop	2-20 even, Regular (31") and Long (35") inseams	019, 724

EMS PANTS AND SHORTS

74363	Men's	Taclite® EMS Pant	Poly/Cotton Ripstop	28-44 even waist, 30-36 even inseams; 46-54 even waist, unhemmed	019, 724
73309	Men's	Taclite® EMS Short	Poly/Cotton Ripstop	28-54 even waist, 11" inseam	724
74310	Men's	EMS Pant	Poly/Cotton Twill	28-44 even waist, 30-36 even inseams; 46-54 even waist, unhemmed	019, 724
64369	Women's	Taclite® EMS Pant	Poly/Cotton Ripstop	2-20 even, Regular (31") and Long (35") inseams	019
64301	Women's	EMS Pant	Poly/Cotton Twill	2-20 even, Regular (31") and Long (35") inseams	019, 724

BLACK 019

DARK NAVY 724

STATION WEAR





COMPANY SHIRTS CLASSIC FIT

Ready to answer every call through a busy shift, the Company Shirt backs you with a vital layer of safety (certified to NFPA 1975, 2019 edition) in a high-tech, low maintenance fabric. It's made with a soft, yet durable cotton twill that's wrinkle-resistant and stitched with protective Firefly™ thread. The Company Shirt also features heat-resistant melamine buttons and a modern, yet professional collar shape with collar stays. Badge tab and epaulette kit included. Imported.

- + NFPA 1975 (2019) certified
- + Firefly™ thread used throughout construction
- + Melamine buttons
- + Modern collar shape w/collar stays
- + Badge tab & epaulette kit included
- + 100% cotton twill, 5.6-oz.
- + Any and all repairs and alterations must be performed by 5.11 or an authorized service representative

COMPANY PANT 2.0 RELAXED FIT

Under pressure, close to the heat, the Company Pant 2.0 helps you stay focused and ready. Designed with proven, station-ready features, this pant is certified to NFPA 1975 (2019 edition). It's constructed with a TOUGH COTTON™ finished twill and stitched with heat-resistant Firefly™ thread from top to bottom. Last but not least, the self-adjusting waistband with gripper elastic helps keep your shirt tucked in, even if everything else around you is coming unhinged. Imported.

- + NFPA 1975 (2019) certified
- + Self-adjusting waistband
- + 4 pockets or 6 pockets
- + Firefly™ thread used throughout
- + 100% cotton twill with a TOUGH COTTON™ finish, 7.8-oz.
- + Any and all repairs and alterations must be performed by 5.11 or an authorized service representative

COMPANY SHIRTS

72515	Men's	Company Shirt	Long-Sleeve	S-3XL, L-5XL Tall (72515T)	010, 696, 720
71391	Men's	Company Shirt	Short-Sleeve	S-3XL, L-5XL Tall (71391T)	010, 696, 720
62399	Women's	Company Shirt	Long-Sleeve	XS-2XL	010, 696, 720
61321	Women's	Company Shirt	Short-Sleeve	XS-2XL	010, 696, 720

COMPANY PANT 2.0

74508	Men's	Company Pant 2.0	TOUGH COTTON™ finished twill	28-44 even waist, unhemmed; 46-54 even waist, unhemmed	720
74509	Men's	Company Cargo Pant 2.0	TOUGH COTTON™ finished twill	28-44 even waist, unhemmed; 46-54 even waist, unhemmed	720
64435	Women's	Company Pant 2.0	TOUGH COTTON™ finished twill	2-20 even waist, unhemmed	720
64436	Women's	Company Cargo Pant 2.0	TOUGH COTTON™ finished twill	2-20 even waist, unhemmed	720

WHITE 010

MEDIUM BLUE 696

FIRE NAVY 720



ALS/BLS Bag, p 269
ALS Operator Backpack, p 267



Canvas collar and elbows.



1/4 Zip collar.



Available also in Heather Grey and Range Red.

JOB SHIRTS

Provides superior versatility and utility while remaining tough, comfortable, and professional. The shirt offers warmth and breathability, and our exclusive Chest BreakThrough pocket utilizes a hook-and-loop divider to keep your gear within reach. Also featuring a no-roll collar, mic loops, side-seam hand-warmer pockets, and sleeve pocket. The Job Shirt is available in a range of styles, including a water-resistant version made with Storm Cotton™ and the value-minded Utility Job Shirt. Imported.



STORM COTTON

Storm Cotton™ offers protection from light rain showers.

JOB SHIRTS					
72321	Job Shirt	10.2-oz., 82% cotton / 18% polyester	Canvas Collar and Elbows	S-3XL, L-5XL Tall (72515T)	720
72301	Job Shirt	10.2-oz., 82% cotton / 18% polyester	Denim Collar and Elbows	S-3XL	720
72314	1/4-Zip Job Shirt	10.2-oz., 82% cotton / 18% polyester	Quarter-zip front	S-3XL, L-5XL Tall (72515T)	016, 019, 720
72363	Water-Repellent Job Shirt	10.2-oz., 82% cotton / 18% polyester	Storm Cotton™ and Quarter-zip front	XS-3XL	720
72441	Utility Job Shirt	7.3-oz., 60% cotton / 40% polyester	Quarter-zip front	XS-4XL, L-5XL Tall (72441T)	477, 720

BLACK 019

HEATHER GREY 019

RANGE RED 477

FIRE NAVY 720

PATCHES, HATS & LOGOWEAR

Show a little Always Be Ready® attitude at the range, the weekend trail run or wherever you want with 5.11 branded t-shirts, patches, hats and now even socks.







81024 USA Patch | Black 019, Double Tap 026, Sand 038, Coyote 120, OD Green 182, Red 460 |



81200 Arizona Flag | Multi 999 |



81071 CA State Bear | Double Tap 026, Coyote 190, Multi 999 |



81198 Colorado Flag | Multi 999 |



81235 Florida Flag | Multi 999 |



81237 Georgia Flag | Multi 999 |



81196 | Hawaii State Flag | Multi 999 |



81214 Maryland Flag | Multi 999 |



81217 Massachusetts Flag | Multi 999 |



81257 Minnesota Flag | Multi 999 |



81199 Nevada Flag | Multi 999 |



81233 New Jersey Flag | Multi 999 |



81234 New York Flag | Multi 999 |



81236 North Carolina Flag | Multi 999 |



81216 Oregon Flag | Multi 999 |



81197 Texas Flag | Coyote 120, Multi 999 |



81159 Keep Texas Tactical | Medium Grey 037 |

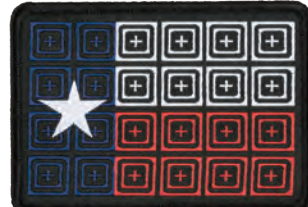

81160 Reticle Flag | Black 019 |



81288 Utah State | Multi 999 |



81215 Virginia Flag | Multi 999 |



81213 Washington D.C. Flag | Multi 999 |



81209 Canada Flag | Charcoal 018, Coyote 120, Red 460, Sage Green 831 |



81292 USA Flag Woven | Double Tap 026, Coyote 120, Red 460 |



81293 USA Flag Reversed Woven | Double Tap 026, Coyote 120, Red 460 |



81291 Thin Blue Line Rubber | Black 019 |



81297 Thin Blue Line Reversed Rubber | Black 019 |



81298 Thin Blue Line Woven | Black 019 |



81299 Thin Blue Line Woven Reversible | Black 019 |



81343 Mini Flag | Black 019, Multi 999 |



81260 Legacy Woven | Multi 999 |



81251 5.11 Scope Large (6" x 3") | Multi 999 |



81322AN Blood Type A Neg
81322AP Blood Type A Pos
81322BN Blood Type B Neg
81322BP Blood Type B Pos
81322ON Blood Type O Neg
81322OP Blood Type O Pos

81438 WriteBar™ Name Tape 3x1 | Black 019, Kangaroo 134, Ranger Green 186, Fire Red 474 |

81437 WriteBar™ Name Tape 6x1 | Black 019, Kangaroo 134, Ranger Green 186, Fire Red 474 |



WriteBars allow you to easily label and ID your camp gear, range gear, or any item with a nametape holder with an enamel marker (market not included).



89061 Operator 2.0 A-Flex Cap
| Black 019, Storm 092, Sage
Green 831 | M/L, L/XL |



89406 Flag Bearer Cap | Black
019, Khaki 055, Storm 092,
Burnt 117, Ranger Green 186,
Ensign Blue 678, Dark Navy 724
| One Size |



**89063 MultiCam Flag Bearer
Cap** | Multicam 169 | One Size
|



89137 Flag Bearer Scope Cap
| Black 019, Khaki 055, Ranger
Green 186 | One Size |



89075 Kryptek Cap | Typhon
099, Highlander 159 | One Size
|



89134 Vent-Tac Cap | Black
019, Green 194 | One Size |



**89406G7 GE07 Flag Bearer
Cap** | Night 357, Terrain 865 |
One Size |



89130 Stuntman Trucker Cap |
Multi 999 | One Size |



89133 Caliber Reticle Cap |
Storm 092, Dark Navy 724 | One
Size |



89132 Caliber 2.0 Cap | Black
019, Green 194 | One Size |



89135 Name Plate Cap | Black
019, Storm 092, Ranger Green
186, Dark Navy 724 | One Size
|



89096 XTU Cap | Black 019,
Dark Navy 724 | One Size |



89260 Uniform Cap | Black 019,
TDU Green 190, Dark Navy 724 |
One Size |



89381 Taclite Uniform Cap |
Black 019, TDU Khaki 162, TDU
Green 190, Dark Navy 724 | One
Size |



89381G7 GE07 Uniform Cap
| Night 357, Terrain 865 | One
Size |



89098 Fast-Tac Uniform Cap |
Black 019, Ranger Green 186,
TDU Green 190, Dark Navy 724 |
One Size |



89095 Foldable Uniform Cap |
Black 019, Dark Navy 724 | One
Size |



**89099 Foldable Hi-Vis Uniform
Cap** | Hi-Vis Orange 405 | One
Size |



89422 5.11 Boonie | Black 019,
TDU Khaki 162, Ranger Green
186, TDU Green 190, Dark Navy
724 | M/L, L/XL |



89422G7 GE07 Boonie | Night
357, Terrain 865 | M/L, L/XL |



89076 5.11 Boonie Multicam
| Multicam 169 | M/L, L/XL |



89089 5.11 Boonie Kryptek |
Typhon 099, Highlander 159 |
M/L, L/XL |



10041AB Sock and Awe AF |
Red 460 |



10041AM Sock and Awe OF OD |
Multi 999 |



89250 Watch Cap | Black 019,
Coyote 120, OD Green 182, Dark
Navy 724 | S/M, L/XL |



89430 5.11 Balaclava | Black
019, Dark Navy 724 | S/M, L/XL |



89367 Underhelmet Skull Cap |
Black 019 | One Size |



10041AA Sock and Awe TBL |
Black 019 |



10041AP Sock and Awe TRL |
Multi 999 |



10041AK Sock and Awe Airraid |
Multi 999 |



10041AO Sock and Awe TacTex
| Multi 999 |



41191JS Legacy USA Fill Tee | Charcoal Heather 033 | S-2XL |



41191AAZ Legacy USA Blue Fill Tee | Navy Heather 749 | S-2XL |



41191POW Diamond Crest Tee | Military Green Heather 223 | S-2XL |



41191RRW Banners and Bayonets Tee | Charcoal Heather 035, Military Green Heather 223 | S-2XL |



41195LKW Dusty Blue Line Tee | Black 019 | S-2XL |



411950PW Eagle Strike Tee | Black 019 | S-2XL |



41195LJW Vintage Flag Tee | Black 019 | S-2XL |



41195QXW Freedom Is Not Free Tee | Cream 342 | S-2XL |



41195RJW America The Beautiful Tee | Black 019 | S-2XL |



41195RUW Alpha Dog Tee |
Black 019 | S-2XL |



41195SFW Stunt Man Tee |
Navy 728 | S-2XL |



**31022AAI Women's Legacy
USA Flag Fill Tee |** Charcoal
Heather 035 | XS-XL |



**31022ABF Women's Legacy
Blue Fill Tee |** White 010 | XS-
XL |



**31022MQ Women's Ammo
Queen Tee |** Black 019 | XS-XL
|



**3102200W Women's True Love
Tee |** Black 019 | XS-XL |



**31022PUW Women's Sunday
Gunday Tee |** White 010 | XS-XL
|



**31022RPW Women's Life Isn't
Perfect Tee |** Military Green
Heather 223 | XS-XL |



**31022RQW Women's Happy
At The Range Tee |** Black 019 |
XS-XL |

ABOUT 5.11

A FOUNDATION BUILT ON PURE GRANITE



The name "5.11" derives from the most difficult rock-climbing level listed in the Yosemite Decimal System during the 1970s. The rating system was developed by legendary rock climber Royal Robbins and his group of fellow climbers. Robbins pioneered free climbing, preferring to scale grueling routes without hammering pitons into the rock.

5.11 Climbing Difficulty: "After thorough inspection, you conclude this move is obviously impossible; however, occasionally someone actually accomplishes it."

THE ORIGINAL 5.11 PANT

Using his climbing experiences in Yosemite, Royal Robbins began manufacturing technical climbing pants and shorts in 1968. Robbins, along with his wife Liz, founded the outdoor apparel company Royal Robbins, Inc. and later introduced the official 5.11 Pant which became a favorite among climbing and outdoor enthusiasts.



THE FBI CONNECTION

In 1993, the FBI Academy in Quantico, VA chose the 5.11 Pant as its standard-issue training pant. FBI New Agents and FBI National Academy Students were issued 5.11 pants, now known as the 5.11 Tactical Pant. The FBI Academy trains FBI employees as well as US Federal, State and Local Agencies and Law Enforcement Executives from allied countries around the world. Attendees of the FBI Academy are still issued 5.11 Pants and Polos as part of their training uniforms.



5.11® IS A PROUD DIAMOND SPONSOR OF THE FBNA



5.11 AT A GLANCE

 **+ 1000+ Employees Worldwide**

 **+ 20,000,000+ pants sold**

 **+ Eight Corporate Offices**

- Dev Center - Irvine, CA, USA
- Ops Center - Manteca, CA, USA
- Limhamn, Sweden
- Kowloon Bay, Hong Kong
- Ciudad de Mexico, Mexico
- Bankstown, Australia
- Dubai, United Arab Emirates
- São Paulo, SP, Brasil

 **+ More than 50 issued and pending patents worldwide**

- Highlights include Flex-Tac[®] Fabric, the HEXGRID[®] System, Apex[™] Pants and 5.11 Stryke[®] Pants

 **+ 2300+ Dealers Worldwide**

 **+ 60+ 5.11 Retail Locations Worldwide**

READY TODAY AND FOR TOMORROW

5.11 remains dedicated to solving the challenges of professionals and elite end-users around the world. We push through traditional product development boundaries, bringing to market new technologies and purpose-built gear that lives up to our heritage and your expectations.

We never rest. Fueled by a passion for innovation, we are always developing new product solutions to help you tackle your toughest challenges head on.

5.11 

FOOTWEAR

Breaching doors, 12 hour patrol shifts, outdoor adventures or serious workout routines? We have purpose-built footwear for all of those missions, and more.





WHEN YOU CARRY ALL OF THIS... (AND MORE)



YOU NEED A.T.L.A.S.



The All Terrain Load Assistance System (A.T.L.A.S.) has been created for operators who routinely carry heavy loads - for long durations. A.T.L.A.S. boots feature a high level of built-in structure and layered cushioning and support to help keep you focused on your mission, not on your feet.

5.11® A.T.L.A.S. SYSTEM

We designed the All Terrain Load Assistance System (A.T.L.A.S.) to provide a more structured supportive and cushioning boot. If you're reading this, chances are you throw on a substantial amount of gear before you start doing work. Agility, stability and durability are essential footwear performance features, and they're reduced by carrying all the gear essential in law enforcement work. We've listened, learned and put our time and attention into a footwear system that enhances your agility, stability and provides a durable platform.

A.T.L.A.S. boots feature a high level of built-in structure and layered cushioning to provide an exceptionally supportive boot for you and other end users like you. A new Ortholite® footbed and an axis plate for torsion and stability control help manage the weight. So too does the echo foam/force foam midsole, which enhances rebound with heavy loads.



NEW

5.11® A.T.L.A.S. TRAINER

Ortholite®

Get your physical training off on the right foot. All the features of the All Terrain Load Assistance System are available in a shoe designed to help you undergo every kind of workout punishment you can stand. And some you can't. The 5.11 A.T.L.A.S. Trainer offers comfort, agility, flexibility, and durability for your cross training, functional fitness and heavy workouts. Imported.

- + High abrasion mesh with welded support for structure
- + Echo Lite high rebound EVA outsole

12429 5.11 A.T.L.A.S. Trainer | Black 019, Dark Coyote 106 | Regular 4, 5, 6-12, 13, 14, 15 |

KEY A.T.L.A.S. Features:

- + Structured upper for support
- + Welded mesh for lightweight performance
- + Robust lacing system with locking ankle eyelet for secure all-day fit
- + Ortholite® footbed
- + Echo Foam high rebound PU and Force Foam lightweight cushioning footbed
- + 5.11 Axle plate torsion board for stability
- + Aggressively treaded outsole with high-traction compound



NEW

5.11® A.T.L.A.S. MID

Ortholite®

This is the 5.11 A.T.L.A.S. Mid Boot. That's mid-height, not mid-night, though it will find favor on that shift to be sure. Featuring 3D molded TPR toe and heel protection, a welded/mesh upper, and high performance, high traction outsole, the All Terrain Load Assistance System will mitigate the rigors of a heavy load bearing job (and in no small way, either). Work longer, with less stress even when you're loaded down with All. The. Things. Imported.

- + 5.11 A.T.L.A.S. Plate
- + Echo Foam high rebound PU and Force Foam lightweight PU cushioning
- + Ortholite® footbed

12430 5.11 A.T.L.A.S. Mid Boot | Black 019, Dark Coyote 106 | Regular 4, 5, 6-12, 13, 14, 15 | Wide 7-12, 13, 14 |



NEW

5.11® A.T.L.A.S. 8" SZ

Ortholite®

The 5.11 A.T.L.A.S. 8" Side Zip is a performance boot built from the sole up to increase performance. The All Terrain Load Assistance System is a force multiplier for those who carry heavy weight on long shifts. This boot is constructed of nylon with high abrasion air mesh, a water resistant leather upper, and because so many arduous jobs demand it - a polishable toe. Additional features include a YKK® side zipper and a locking ankle eyelet, and a slip- and oil-resistant outsole so you can take those corners in a foot pursuit or run headlong into whatever challenge you're up against. Imported.

- + 5.11 A.T.L.A.S. Plate
- + Echo Foam high rebound PU and Force Foam lightweight PU cushioning
- + Ortholite® footbed

12431 5.11 A.T.L.A.S. 8" Side Zip Boot | Black 019 | Regular 4, 5, 6-12, 13, 14, 15 | Wide 7-12, 13, 14 |



NEW

5.11® A.T.L.A.S. 8" NZ

Ortholite®

The 8 in. 5.11 A.T.L.A.S. is a performance boot built from the sole up to increase performance. The All Terrain Load Assistance System is a force multiplier for those who carry heavy weight on long shifts. This boot is constructed of nylon with high abrasion air mesh, a water resistant suede upper. Additional features include a YKK® side zipper and a locking ankle eyelet, and a slip- and oil-resistant outsole so you can take those corners in a foot pursuit or run headlong into whatever challenge you're up against. Imported.

- + 5.11 A.T.L.A.S. Plate
- + Echo Foam high rebound PU and Force Foam lightweight PU cushioning
- + Ortholite® footbed

12422 5.11 A.T.L.A.S. 8" Non-Zip Boot | Black 019, Dark Coyote 106 | Regular 4, 5, 6-12, 13, 14, 15 | Wide 7-12, 13, 14 |



APEX™ 8" WATERPROOF



The Apex WP 8" Boot is ready when you are with its waterproof full grain leather upper. The Vibram® MegaGrip outsole formula keeps you sure footed and stable and the boot is resoleable. Inside, you'll have total support and cushioning hour after hour with the D30® Lite EVA midsole and D30® Support foot bed maximum comfort and heel/arch support. And with eVent® BBP waterproof membrane lining and a high abrasion reinforced heel, braving the elements is like a walk in the park. Imported.

- + Waterproof full grain leather upper
- + eVent® waterproof, breathable, BBP resistant membrane
- + D30® Lite midsole, fiberglass shank

12374 Apex Waterproof 8" Boot | Black 019, Dark Coyote 106 | Reg: 7-12, 13, 14, 15; Wide: 7-12, 13, 14 |



APEX™ 8"



Tough as nails and amazingly comfortable Apex 8" looks to be your new favorite boot. From the base to the exterior, superior quality materials set the tone for maximum performance. We built this boot on a resoleable Vibram® Maltese outsole and added Vibram's Megagrip compound for excellent traction on dry or wet terrain. The Apex 8" also features a D30® Support footbed and D30® Lite EVA midsole for unbeatable support and all-day comfort. An 8" full grain leather upper with a high abrasion reinforced heel seals the deal. Imported.

- + Full grain leather upper
- + D30® Lite midsole, fiberglass shank

12381 Apex 8" Boot | Black 019 | Reg: 7-12, 13, 14, 15; Wide: 7-12, 13, 14 |



APEX™ 6" WEDGE



The Apex 6 Wedge is built with a D30® support footbed for revolutionary shock absorption, all day comfort, and lasting heel and arch support. Its lightweight Vibram® Christy resoleable outsole gives all day stability and comfort.. The outsole also features Vibram Newflex to maximize your grip and enhance your energy. The APEX wedge is ready to put some in serious miles in over all kinds of territory. Count on it. Imported.

- + Full grain leather upper
- + D30® footbed for all-day cushioning & support

12413 Apex 6" Wedge | Rust 140 | Reg: 7-12, 13, 14, 15; Wide: 7-12, 13, 14 |



A.T.A.C.® 2.0 COLLECTION

The boot worn by the world's leading public safety personnel, the 5.11® A.T.A.C., just got promoted. It's lighter and more comfortable, yet maintains its reputation for toughness and durability. A new air flow tongue and full-length dual durometer Ortholite® footbed work to keep your feet cool, dry and comfortable all day, every day. Another new feature, the Achilles heel flex zone, gives a critical part of your foot more range of motion without compromising support. The full-grain leather toe, 840D nylon upper and shock mitigation system provide the kind of rugged protection you need; while the knife pocket keeps an important ally within reach. Imported.

A.T.A.C. 2.0 NEW FEATURES

- High air-flow, breathable tongue
- 840D Nylon abrasion resistant upper
- Lighter weight construction,
- Full length dual durometer Ortholite® footbed
- Achilles flex zone with Ortholite foam for more comfort & performance
- Strobel construction for comfort

CARRY-OVER FEATURES

- Full grain leather toe
- High abrasion nylon upper
- YKK® side zipper (select styles)
- Knife pocket
- Shock Mitigation System®
- Slip- and oil-resistant outsole
- ProFit silhouette



A.T.A.C.® 2.0 8" SZ

Ortholite®

- + Waterproof full grain leather and 840D nylon upper
- + YKK® full length side zipper
- + Ortholite® footbed

12391 A.T.A.C.® 2.0 8" SZ | Black 019 | R: 4, 5, 6-12, 13, 14, 15; W: 7-12, 13, 14 |

12403 Women's A.T.A.C. 2.0 8" SZ | Black 019 | 5-10 Regular |

**A.T.A.C.® 2.0 8" STORM**

Ortholite®

- + Waterproof full grain leather and 840D nylon upper
- + 5.11 SlipStream® Waterproof and BBP resistant membrane lining
- + YKK® full length side zipper

12392 A.T.A.C. 2.0 8" Storm | Black 019 | 4,5,6-12,13,14,15 Regular, 7-12,13,14 Wide |

12406 Women's A.T.A.C. 2.0 8" Storm | Black 019 | 5-10 |

**A.T.A.C.® 2.0 8" SHIELD**

Ortholite®

- + Waterproof full grain leather and 840D nylon upper
- + ASTM 2413-11 M I/75 C/75 EH PR Certified & CSA Z195-14 Certified
- + 5.11 SlipStream® Waterproof and BBP resistant membrane lining

12416 A.T.A.C.® 2.0 8 Shield | Black 019 | R: 4, 5, 6-12, 13, 14, 15; W: 7-12, 13, 14 |

**A.T.A.C.® 2.0 6" SZ****Ortholite®**

- + Waterproof full grain leather and 840D nylon upper
- + YKK® full length side zipper
- + Ortholite® footbed

12394 A.T.A.C. 2.0 6" SZ | Black 019 | 4,5,6-12,13,14,15 Regular, 7-12,13,14 Wide |

12403 Women's A.T.A.C. 2.0 6" SZ | Black 019 | 5-10 |

**A.T.A.C.® 2.0 6" NZ****Ortholite®**

- + Waterproof full grain leather and 840D nylon upper
- + Ortholite® footbed

12401 A.T.A.C. 2.0 6" NZ | Black 019 | 4,5,6-12,13,14,15 Regular, 7-12,13,14 Wide |

12405 Women's A.T.A.C. 2.0 6" NZ | Black 019 | 5-10 |



A.T.A.C.® 2.0 8" ARID

Ortholite®

- + Full grain suede leather and 840D nylon upper
- + Agion® odor-control treatment
- + YKK® full length side zipper

12417 A.T.A.C.® 2.0 8 Arid | Coyote 120 | R: 4, 5, 6, 7-12, 13, 14, 15; W: 7-12, 13, 14 |



A.T.A.C.® 2.0 8" DESERT

Ortholite®

- + Full grain suede leather and 840D nylon upper
- + YKK® full length side zipper
- + Ortholite® footbed

12393 A.T.A.C. 2.0 8" Desert | Dark Coyote 106 | 4,5,6,7-12,13,14,15 | Reg 7-12,13,14 Wide |



A.T.A.C.® 2.0 6" SZ DESERT

Ortholite®

- + Full grain suede leather and 840D nylon upper
- + YKK® full length side zipper
- + Ortholite® footbed

12395 A.T.A.C. 2.0 6" SZ Desert | Dark Coyote 106 | 4,5,6,7-12,13,14,15 | Regular, 7-12,13,14 Wide |



A.T.A.C.® 2.0 6" NZ DESERT

Ortholite®

- + Full grain suede leather and 840D nylon upper
- + Ortholite® footbed

12402 A.T.A.C. 2.0 6" NZ Desert | Dark Coyote 106 | 4,5,6,7-12,13,14,15 | Regular, 7-12,13,14 Wide |

FAST-TAC® COLLECTION

Whether you're gearing up for duty or deployment, the high-performance 5.11® Fast-Tac® Boot provides the mobility and comfort you need at a great value. The lightweight Fast-Tac is built on our rugged Speed 3.0 all-terrain cup outsole platform. A fence-climbing toe, self-cleaning forefoot lugs and arch lugs give you the upper hand when climbing and scrambling over obstacles. The oil- and slip-resistant tread also provides superior traction on most surfaces. Thanks to the enhanced cushioning power of the Ortholite insole, you can face those long assignments in comfort. The Fast-Tac is available in six- and eight-inch versions with a range of options, including a polishable full-grain leather/high-abrasion nylon upper and a suede/high-abrasion nylon upper.



FAST-TAC® 8"

Ortholite®

- + Leather and high-abrasion 840D nylon upper
- + Ortholite® footbed
- + Speed all-terrain cup outsole for traction in any environment

12387 Fast-Tac® 8 | Black 019 | R: 4, 5, 6, 7-12, 13, 14, 15; W: 7-12, 13, 14 |



FAST-TAC® 6"

Ortholite®

- + Leather and high-abrasion 840D nylon upper
- + Ortholite® footbed
- + Speed all-terrain cup outsole for traction in any environment

12380 Fast-Tac® 6" Boot | Black 019 | 4, 5, 6-12, 13, 14, 15 Regular, 7-12, 13, 14 Wide |



FAST-TAC® 6" WATERPROOF

SLIP STREAM™ Ortholite®

- + Leather and high-abrasion 840D nylon upper
- + Waterproof BBP-resistant 5.11® SlipStream™ membrane
- + Ortholite® footbed
- + Speed all-terrain cup outsole for traction in any environment

12388 Fast-Tac® 6 Waterproof | Black 019 | R: 4, 5, 6, 7-12, 13, 14, 15; W: 7-12, 13, 14 |



FAST-TAC® 8" DESERT

Ortholite®

- + Suede and high-abrasion 840D nylon upper
- + Ortholite® footbed
- + Speed all-terrain cup outsole for traction in any environment

12414 Fast-Tac® 8 Desert | Dark Coyote 106 | R: 4, 5, 6, 7-12, 13, 14, 15; W: 7-12, 13, 14 |



FAST-TAC® 6" DESERT

Ortholite®

- + Suede and high-abrasion 840D nylon upper
- + Ortholite® footbed
- + Speed all-terrain cup outsole for traction in any environment

12415 Fast-Tac® 6 Desert | Dark Coyote 106 | R: 4, 5, 6, 7-12, 13, 14, 15; W: 7-12, 13, 14 |

EVO COLLECTION

Mobility is the ability to move freely and easily. Add durability, stability, and high performance to that definition, you've got 5.11's EVO Boot. Non-waterproof boot versions feature a cemented, fully-stitched (non-waterproof versions) EVO Prime platform with cutting-edge, dynamic D30 cushioning and Ortholite® insoles for ultimate comfort. A full-length EVA midsole with a nylon shank for promotes peak stability and ease of wear. And a stitched-cup outsole with oil- and slip-resistant climbing lugs catapult the EVO Boot to the apex of tactical footwear. Available in 6" and 8" heights, the boot is non-metallic, lightweight, and has a 14 mm heel-to-toe drop for a responsive, natural stance. The waterproof model features a breathable eVent® waterproof and bloodborne pathogen-resistant membrane. The insulated model features eVent® and 400g PrimaLoft insulation. This isn't just a boot built for battle. It's a boot built for victory. Imported.



EVO 8"

D30 Ortholite®

- + Full grain leather and 1200D nylon upper with welded overlay
- + YKK® full length side zipper
- + Ortholite® footbed, D30® Decell heel insert

12310 EVO 8" | Black 019 | 4, 5, 6-12, 13, 14, 15 Regular | 7-12, 13, 14 W



EVO 8" CST

D30 Ortholite®

- + Full grain leather and 1200D nylon upper with welded overlay
- + ASTM F 2413-11 certified safety toe
- + YKK® full length side zipper
- + Ortholite® footbed, D30® Decell heel insert

12354 EVO 8" CST | ASTM F2413-11 M I/75 C/75 Certified | eVent® WP/B | Black 019 | Regular 4, 5, 6-12, 13, 14, 15 | Wide 7-12, 13, 14 |



EVO 6 WATERPROOF™

eVent D30 Ortholite®

- + Full grain leather and 1200D nylon upper with welded overlay
- + eVent® waterproof, breathable, BBP resistant membrane
- + YKK® full length side zipper
- + Ortholite® footbed, D30® Decell heel insert

12313 EVO 6" Waterproof | eVent® WP/B | Cold weather outsole compound | Black 019 | 4, 5, 6-12, 13, 14, 15 Regular | 7-12, 13, 14 W |

**EVO 6"**
 Ortholite®

- + Full grain leather and 1200D nylon upper with welded overlay
- + YKK® full length side zipper
- + Ortholite® footbed, D30® Decell heel insert

12311 EVO 6" | Black 019 | 4, 5, 6-12, 13, 14, 15 Regular | 7-12, 13, 14 W |

**EVO 8" WATERPROOF**
  Ortholite®

- + Full grain leather and 1200D nylon upper with welded overlay
- + eVent® waterproof, breathable, BBP resistant membrane
- + YKK® full length zipper
- + Ortholite® footbed, D30® Decell heel insert

12312 EVO 8" Waterproof | eVent® WP/B | Cold weather outsole compound | Black 019 | 4, 5, 6-12, 13, 14, 15 Regular | 7-12, 13, 14 W |

**EVO 8" DESERT**
 Ortholite®

- + Nubuc leather and 1200D nylon upper with welded overlay
- + YKK® full length side zipper
- + Ortholite® footbed, D30® Decell heel insert

12347 EVO Desert 8" | Suede leather | Coyote 120 | 4, 5, 6-12, 13, 14, 15 Regular | 6-12, 13, 14 Wide |

**EVO 8" INSULATED**
   Ortholite®

- + Full grain leather and 1200D nylon upper with welded overlay
- + PrimaLoft® insulation
- + eVent® waterproof, breathable, BBP resistant membrane
- + Ortholite® footbed, D30® Decell heel insert

12348 EVO 8" Insulated | PrimaLoft Insulation & eVent® WP/B | Black 019 | 4, 5, 6-12, 13, 14, 15 Regular | 7-12, 13, 14 W |

SPEED 3.0 COLLECTION

When you need a tough, all-duty boot that can handle your pace without breaking the bank, reach for the 5.11® Speed 3.0. This lightweight and breathable footwear solution comes in a wide range of options, including a polishable full-grain leather toe and a suede upper. The enhanced cushioning of the OrthoLite® insole helps you stay on your feet longer while the anti-microbial Agion® odor-control lining keeps your boots fresh. Self-cleaning forefoot lugs, a fence-climbing toe and arch lugs molded into the Speed all-terrain cup outsole provide stability and extra assistance when climbing ladders and ropes or crossing that fence in your way. A side zipper on select models provides quick on and off—perfect for changing in tight quarters. Grab a pair of Speed 3.0 boots and get moving.



SPEED 3.0 8" SZ

OrthoLite®

- + Full grain leather and nylon upper
- + YKK® full length side zipper
- + Agion® odor-control lining
- + OrthoLite® footbed

12336 Speed 3.0 Sidezip Boot | Black 019 | Regular 4, 5, 6-12, 13, 14, 15 | Wide 7-12, 13, 14 |



SPEED 3.0 8" RAPIDRY

OrthoLite®

- + RapiDry upper with drainage vents
- + Agion® odor-control lining
- + OrthoLite® footbed and sockliner

12339 Speed 3.0 RapiDry | Black 019 | Regular 4, 5, 6-12, 13, 14, 15 | Wide 7-12, 13, 14 |



SPEED 3.0 5"

OrthoLite®

- + Full grain leather and nylon upper
- + Agion® odor-control lining
- + OrthoLite® footbed

12355 Speed 3.0 5" | Black 019 | Regular 4, 5, 6-12, 13, 14, 15 | Wide 7-12, 13, 14 |



SPEED 3.0 8" WATERPROOF

SLIP
STREAM™ Ortholite®

- + Full grain leather and nylon upper
- + 5.11® SlipStream™ waterproof, BBP-resistant membrane with low friction lining
- + Agion® odor-control lining
- + Ortholite® footbed

12371 Speed 3.0 Waterproof Boot | Black 019 | 4, 5, 6-12, 13, 14, 15 regular width, 7-12, 13, 14 wide width |



SPEED 3.0 8" SHIELD CST

Ortholite®

- + Full grain leather and nylon upper
- + Lightweight Carbon Tac safety toe certified to ASTM 2413-11 & CSA
- + YKK® full length side zipper
- + Agion® odor-control lining

12378 Speed 3.0 8" Shield (CST) Boot | ASTM 2413-11/CSA Certified | Black 019 | 4, 5, 6-12, 13, 14, 15 Regular, 7-12, 13, 14 Wide |



SPEED 3.0 8" DESERT

Ortholite®

- + Suede leather and nylon upper with drainage vents
- + Agion® odor-control lining
- + Ortholite® footbed

12337 Speed 3.0 Desert Side Zip | Coyote 120 | Regular 4, 5, 6-12, 13, 14, 15 | Wide 7-12, 13, 14 |



SPEED 3.0 8" JUNGLE

Ortholite®

- + RapiDry upper with drainage vents
- + Agion® odor-control lining
- + Ortholite® footbed and sockliner

12338 Speed 3.0 Jungle | Dark Coyote 106 | Regular 4, 5, 6-12, 13, 14, 15 | Wide 7-12, 13, 14 |

COMPANY BOOTS

Our tough-as-nails 5.11® Company Boots are ready to roll with you on a medical call or pull an extra shift at the firehouse. The updated collar on the new Company 3.0 makes these boots even more comfortable to wear



NEW

COMPANY 3.0

Ortholite®

Featuring a nylon collar at the mouth for easy donning and doffing and a high traction outsole with climbing lug, this boot is made to move no matter how damn bad the footing is. Force foam PU cushioning helps protect your feet from fatigue.

- + Industrial grade leather upper
- + Nylon collar with improved slip-on fit for easy donning and doffing
- + Force foam PU foam cushioning, Ortholite® footbed

12420 Company 3.0 Boot | Black 019 | Regular 4, 5, 6-12, 13, 14, 15 | Wide 7-12, 13, 14 |

and easier to remove when you're changing into turnout gear. A non-slip outsole keeps you on your feet in wet truck bays and a combination of Force Foam PU cushioning and OrthoLite® insoles help fight fatigue.



NEW

COMPANY 3.0 CST

Ortholite®

The Company 3.0 CST is an ultra lightweight work boot with a certified safety toe and a puncture resistant Wellmax board in the footbed. The Carbon-Tac Safety Toe is about 20% thinner and about 30% lighter than a standard composite toe cap. Force foam PU cushioning helps protect your feet from fatigue.

- + Industrial grade leather upper
- + ASTM F2413-17 M I/75 C/75 EH PR certified boot with CSA Z195 puncture resistant Wellmax board in footbed,
- + ASTM Certified Carbon Tac Safety Toe
- + Nylon collar with improved slip-on fit for easy donning and doffing
- + Force foam PU foam cushioning, Ortholite® footbed

12421 Company 3.0 CST Boot | Black 019 | Regular 4, 5, 6-12, 13, 14, 15 | Wide 7-12, 13, 14 |



COMPANY 2.0™

Ortholite®

The Company 2.0 gives you the power and elite performance of our A.T.A.C.® boot in a convenient, pull-on boot. Imported.

12032 Company 2.0 Boot | Black 019 | Regular 4, 5, 6-12, 13, 14, 15 | Wide 7-12, 13, 14 |



COMPANY 2.0™ CST

Ortholite®

The Company 2.0 CST features a ASTM F2413-05 M I/75 C/75 EH PR certified composite safety toe pull-on boot with a full grain leather upper. Imported.

12033 Company 2.0 CST Boot | Black 019 | Regular 4, 5, 6-12, 13, 14, 15 | Wide 7-12, 13, 14 |



SKYWEIGHT 8" WATERPROOF SZ

D3O Ortholite®

- + Clarino® leather and 1200D nylon breathable upper
- + eVent® waterproof, breathable membrane
- + YKK® full length side zipper
- + Non-metallic construction
- + Full length CMEVA midsole with nylon shank, Ortholite® insole

| 12321 Skyweight Waterproof (Side-Zip) | Polishable leather | Black 019 | 4, 5, 6-12, 13, 14, 15 Regular, 6-12, 13 Wide Width |



MOTO BOOT

Ortholite®

Ride well with the knowledge that our new Moto Boot is built to provide comfort, flexibility and easy wear for your next patrol shift. With a mid-calf full grain premium leather upper and a high wear rubber outsole, the Moto is built to last. Articulation is built into the front and rear of the ankle for freedom of movement. An OrthoLite® footbed provides cushioning and a Bi-fit board and nylon shank provide stability and protection and a double-layered toe enhances shifting durability. Imported.

- + Quick lace system for easy wear
- + Double layered toe leather for shifting durability
- + Ankle articulation zones for freedom of movement
- + BiFit board and nylon shank for stability and protection

| 12328 Moto Boot | Black 019 | 7, 8-12 Regular |



XPRT® 3.0 6" WATERPROOF

Aggressive performance meets durability in the XPRT 3.0 Waterproof boot. This athletic boot features full grain waterproof leather, eVent® waterproof breathable and blood borne pathogen resistant membrane and is built on a Vibram® Ananasi outsole with the Vibram Megagrip for traction on all sorts of terrain. An OrthoLite® imperial foodbed ads moisture wicking and long lasting comfort. The XPRT 3.0 Waterproof has a 6" height and has a Kevlar® reinforced heel for durability and a ghillie lacing system with our sausage laces keep the fit locked in.

12373 XPRT 3.0 Waterproof 6" Boot | Black 019, Dark Coyote 106, Dark Earth 282 | 7-12, 13, 14 regular width, 7-12, 13, 14 wide width |





UNION 6" WATERPROOF



When the weekend calls for some serious foot work, the Union Waterproof Boot steps up with outstanding comfort and toughness. The outsole with Vibram® XS-trek formula provides excellent grip and balance, so you can feel confident traversing wet or dry terrains. And the eVent® BBP Waterproof lining gives you all the more reason to ford that stream. Did we mention comfort? A new Ortholite® X-25 footbed gives you the kind of "aah" you feel right away, and cushioning you feel all day. Imported.

- + Waterproof suede upper/high abrasion nylon upper
- + eVent® BBP Waterproof lining
- + Ortholite X-25 footbed for comfort & all day cushioning
- + Vibram Nuansi 2 outsole w/PU midsole using Vibram XS-trek

12390 Union 6" Boot WP | Black 019, Dark Coyote 106 | R: 7-12, 13, 14; W: 7-12, 13, 14 |



CABLE HIKER TACTICAL



Keep your feet feeling, and smelling their best, even on the longest treks, in the 5.11 Cable Hiker Tactical boot. Engineered for ultimate comfort and durability, the Cable Hiker Tactical features industry-leading 5.11 SlipStream™ Agion® low friction odor-control lining. The OrthoLite® X-40 high-rebound footbed helps your feet recover from impact or shock quickly, and a scratch rubber toe offers heightened protection. This hiker sits on our Speed 3.0 all terrain outsole, 5.11's most advanced, multi-terrain outsole, which provides outstanding stability and comfort even in the harshest environments. Lace them up for a day at the range, a long day at work, or to conquer a tough trail. The Cable Hiker Tactical was born ready. Imported.

- + Rough out suede and nylon upper
- + Agion® low friction antimicrobial lining
- + OrthoLite® X-40 footbed

12418 Cable Hiker Tactical | Dark Coyote 106, Coyote 120 | R: 4, 5, 6, 7-12, 13, 14, 15; W: 7-12, 13 |





NORRIS SNEAKER



It may look like a casual, high-top sneaker, and it is, but the Norris is stacked even higher with style, comfort, and tactical intelligence. The Vibram® Marbrani outsole with XS Trek provides the optimal balance of traction and durability, particularly on wet surfaces, and Ortholite® technology cushions your feet in total support and comfort. The Norris is ASTM certified for puncture resistance and built with a super-strong Welmax board that guards your feet against up to 1,200 newtons of force. From the outside in, this shoe is more than show. Imported.

- + Suede and nylon upper with a rubber toe cap for durability
- + ASTM F2413-11 PR Puncture Resistance Certified
- + New full length Ortholite® footbed
- + Vibram® Marbrani outsole w/XS Trek

12411 Norris Sneaker | Black 019, Ranger Green 186 | R: 4, 5, 6, 7-12, 13 |





MISSION READY™ OXFORD



Mission Ready Oxford helps you stay focused, ready, and light on your feet. The D30® Lite EVA midsole and Ortholite® X-25 footbed provide extra cushioning and all-day comfort, and an Ortholite Achilles Cuff adds even more comfort and heel hold. And when you need to move, the Vibram® Overland high traction outsole with XS Trek lets you step up without slipping up. Imported.

- + Full grain leather upper
- + D30® Lite EVA midsole, Ortholite® X-25 footbed
- + Vibram Overland high traction outsole w/XS Trek

12385 Mission Ready Oxford | Black 019, Flat Dark Earth 131 | Sizes R: 7-12,13,14,15; W: 7-12,13, 14 |



MISSION READY™ CHUKKA



Whether protecting a client, watching over a venue, or working to keep a crowd safe, the Mission Ready Chukka helps you stay focused and ready. The D30® Lite EVA midsole and Ortholite® X-25 footbed provide extra cushioning and all-day comfort, and an Ortholite Achilles Cuff adds even more comfort and heel hold. And when you need to move, the Vibram® Overland high traction outsole with XS Trek helps provide sure footing. Imported.

- + Full grain leather upper
- + D30® Lite EVA midsole, Ortholite® X-25 footbed
- + Vibram Overland high traction outsole w/XS Trek

12386 Mission Ready Chukka | Black 019, Flat Dark Earth 131 | Sizes R: 7-12,13,14,15; W: 7-12,13, 14 |





CUPRON® YEAR ROUND SOCKS

Fight the funk! The Cupron® material built into these socks makes the most of copper's natural antimicrobial properties. Cupron® is EPA approved to kill 99.9% of bacteria. Made with moisture wicking TransDRY® cotton to keep feet cool and dry with a Cupron® copper heel and toe. Nanoglide thread helps prevent blisters. 82% polyester, 16% Cupron® copper yarn, 2% elastane. Made in USA.

10042 Cupron® Year Round Crew Sock | Black 019, Dark Coyote 106 | S/M, L/XL |

10043 Cupron® Year Round OTC Sock | Black 019, Dark Coyote 106 | S/M, L/XL |



CUPRON® 3-PACK SOCKS

Cupron® is EPA approved to kill 99.9% of bacteria. Made with moisture-wicking polyester with a Cupron® copper heel and toe. Odor-control comfort. 82% polyester, 16% Cupron® copper yarn, 2% elastane. Made in USA.

10039 Cupron® 3-Pack OTC Sock | White 010, Black 019 | S/M, L/XL |

10038 Cupron® 3-Pack Crew Sock | Black 019 | S/M, L/XL |



MERINO WOOL SOCKS

Crafted from 144-needle-count Merino wool, featuring NanoGLIDE® technology for blister protection and copper thread for odor-control.

10023 Merino Crew Socks | 019 Black | S,M,L |

10024 Merino OTC Boot Socks | 019 Black | S,M,L |



YEAR-ROUND SOCKS

Knitted with TransDRY® cotton and copper threads for breathability, moisture management, and odor-control performance plus NanoGLIDE® technology for blister protection. USA made.

10014 Year-Round Crew Socks | Black 019 | S/M, L/XL |

10013 Year-Round OTC Socks | Coyote 120 | S/M, L/XL |



SLIPSTREAM SOCKS

NanoGLIDE® knit fiber, friction reducing, moisture-wicking and quick drying performance.

10034 Slipstream OTC Sock | Black 019, Gunmetal 032, Dark Coyote 106 | S, M, L |

10033 Slipstream Crew Sock | Black 019, Gunmetal 032, Dark Coyote 106 | S, M, L |



5.11 TACLITE™ SOCKS

Multiple compression zones, reinforced heel and toe. Imported.

59224 5.11 Taclite™ 9" Socks | Black 019 |

59289 5.11 Taclite™ 6" Socks | Black 019 |



LEVEL 1 SOCKS

Moisture wicking performance, 12 zones of construction. Imported.

59048 Level 1 9" Socks | Black 019, Coyote 120, Foliage 180 |

59047 Level 1 6" Socks | Black 019, Coyote 120 |



3-PACK SOCKS

Moisture wicking performance with multiple compression zones for support. Imported.

59121 3-Pack 9" Socks | A 3-pack of our basic 9" sock. | Black 019 |

50078 3-Pack 6" Socks | A 3-pack of our basic 6" sock. | Black 019 |

10035 3-Pack PT Ankle Sock | White 010, Heather Grey 016, Black 019 | S, M, L |



REPLACEMENT PARACORD LACES

10503 Paracord Laces | Black 019, Coyote 120 | M (63"), L (72"), XL (84") |

SOCK & AWE COLLECTION, PAGE 155



TOOLS & EDC

Whether your daily carry is as simple as a wallet and keys, or a Heavy Breaching Kit, 5.11 has something for you.







MAVERICK ASSAULTERS BELT

The Maverick Assaulters Belt is an ergo-nomic 1-3/4" rigger's belt with a comfortable pre-curved design and AustriAlpin® buckle assembly for stability and quick attach-detach capability. Varying male/female buckles give the Maverick Assaulter convenient one-time fit-and-forget wearability. Imported.

59569 Maverick Assaulters Belt | 1-3/4" width | Black 019, Sandstone 328 | S-4XL



ALTA BELT

Heavy-duty versatility. Alta's 1-3/4" wide webbing effortlessly supports your holster. Paired with tactical pants, used as a tie down or converted to a carry strap, this belt works hard. Imported.

59538 Alta Belt | 1-3/4" width | Black 019, Coyote 120 | Men's S-4XL



TRAINER AND OPERATOR BELTS

Popular among law enforcement professionals, 5.11®'s Trainer and Operator belts are constructed from ultra-strong nylon mesh and features a stainless steel buckle with a 6,000 lbs. rating. Ideal for on- and off-duty wear, the Trainer Belt supports your holster and accessories without sagging, bending, or losing shape. With heavy, reinforced stitching, the Trainer Belt can also quickly convert into a secure tie-down, carry strap, or emergency harness. Now that's utility. Imported.

59409 Trainer Belt | 1-1/2" width w/ matte stainless buckle | Charcoal 018, Tundra 192, Sandstone 328 | S-4XL

59409 Trainer Belt | 1-1/2" width w/ black buckle | Black 019, Coyote 120, TDU Green 190 | S-4XL

59405 Operator Belt | 1-3/4" width, visually similar to Trainer, but heavily stiffened | Black 019, Coyote 120, TDU Green 190 | S-4XL (2XL+)



NEW

SKYHAWK 1.5" BELT

Light, sturdy, and completely non-metallic, the Skyhawk Belt secures with a carefully engineered, POM thermoplastic with a custom designed dual-lock buckle for easy of entry into belt loops without removing the buckle. The belt itself is built with a double layer precurved nylon webbing with heavy bartacks and triple row stitch reinforcement. Because everyone wears their equipment (and their britches) differently, we've added some hook and loop for micro-adjustment.

56591 Skyhawk 1.5" Belt | Black 010, Kangaroo 134 | S-4XL (2XL+)



TDU® BELT

A convenient tactical or patrol belt that excels in a wide range of environments. Crafted from tear-resistant nylon, the belt features a durable non-metallic buckle that won't set off metal detectors. Imported.

59551 TDU 1.5 Belt | 1-1/2" width | Black 019, Coyote 120, TDU Green 190 | S-4XL

59552 TDU 1.75 Belt | 1-3/4" width | Black 019, Coyote 120, TDU Green 190 | S-4XL



DOUBLE-DUTY TDU® BELT

Featuring a dual-layer reversible design, the Double-Duty TDU Belt offers exceptional versatility and efficiency. Crafted from tear-resistant nylon, the belt incorporates a durable non-metallic buckle and five-rows of stitching deliver stability. Two great belts in one. Imported.

59567 1.75" Double-Duty TDU Belt | 1-3/4" width | Black/Coyote 120, Black/TDU Green 190 | S-4XL

59568 1.5" Double-Duty TDU Belt | 1-1/2" width | Black/Coyote 120, Black/TDU Green 190 | S-4XL



LOW PRO TDU® BELT

A staple in the 5.11 Tactical line gets some serious updates. The no-sew construction features modular parts for easy replacement. The custom buckle has been upgraded to provide an even more secure fit, yet the lower inset tension bar presents a flatter profile. 1.5" nylon webbing. Imported.

56514 1.5" Low Pro TDU® Belt | Black 019, Kangaroo 134, Ranger Green 186 | S-4XL



NEW

PRINTED LOW PRO TDU® BELT

A quick and convenient low-pro belt suitable for casual wear in a range of environments, the 1.5 in. Printed Low Pro TDU® Belt features a patent-pending, rugged, precision-designed no-sew Polyoxymethylene buckle and flat nylon webbing with a number of custom print patterns. Use it to keep your pants up, convert it into a secure tie down strap or other improvised use.

56616 Printed Low Pro TDU 1.5" Belt | Black Camo 536, Green Camo 537, | Fits up to 44" |

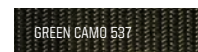
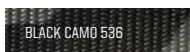



ELAS-TAC BELT

Who says you can't pack a ton of durability into a lightweight, flexible belt? Certainly not us. 5.11's heavy duty, stretchable 1-1/2" Elas-Tac belt is 100% nylon and 200% convenient with hook and loop adjustability and a set-it-and-forget-it, low-profile G-hook buckle. Accent stitching and the 5.11 Scope logo on the belt tip add a hint of style. Imported.

56409 Elas-Tac Belt | 1-1/2" width | Black 019, Kangaroo 134 | S - 4XL



DROP SHOT BELT

The Drop Shot's high-strength 1-1/2" and 1" nylon webbing is your newest strong point. This easily adjustable belt transitions to allow for an IWB conceal carry at the center front. Imported.

59539 Drop Shot Belt | 1-1/2" width | Volcanic 098, Sandstone 328 | Men's S-4XL



TRAVERSE® DOUBLE BUCKLE BELT

The Traverse Double-Buckle is a superior multi-purpose belt, featuring ribbed-weave 1-1/2" nylon webbing for enhanced strength and durability in a comfortable, low-profile design. Imported.

59510 Traverse Double Buckle Belt | 1-1/2" width | Black 019, Battle Brown 116, Sandstone 328 | S-2XL



SI WEB BELT

For a comfortable, secure fit and duty-ready support, The SI Belt just works. The no-sew construction features modular parts for easy replacement, and the custom cam style buckle features ample room for etching and engraving. This belt announces your presence and authority with room to spare. Imported.

56515 SI Web Belt | Black 019, Kangaroo 134, Ranger Green 186 | S-2XL (fits up to 44" waist), 3XL-5XL (fits up to 58" waist)



APEX GUNNER BELT

The Apex Gunner is one of the sturdiest belts you'll find. Made from the material used to hoist elevators, 1-1/2" B10 webbing, the Apex Gunner provides 1,500 lbs. of tensile strength. A TPU coating and pre-curved design ensure enhanced load-bearing capacity and broken-in comfort. The cast aluminum buckle with dual retention prongs adds stability and a clean, professional look. This belt deadlifts elevators. What does yours do? Imported.

59492 Apex Gunner Belt | 1-1/2" width | Black 019 | S-4XL (2XL+)



ARC LEATHER BELT

A premium belt for patrol and CCW wear, the Arc Leather is built from durable, full-grain 4 mm-thick 1-1/2" wide matte leather. Pre-curved and strong, the belt easily supports your holster and resists sagging, bending, and twisting, all while providing broken-in comfort and a sharp, professional look. Everyone needs a leather belt. This one's tough to beat Imported.

59493 Arc Leather Belt | 1-1/2" width | Black 019, Brown 108 | S-4XL



MISSION READY™ BELT

The Mission Ready 1-1/2" Belt fuses the best professional style and tactical functionality. A formal, genuine leather facing is backed by a durable webbing body, and the internal reinforcement provides a stable sidearm platform. And to make sure you're really ready for any and everything, there's a hidden interior cuff key pocket, too. Imported.

59541 Mission Ready Belt | 1-1/2" width | Black 019, Dark Earth 282 | Even waist sizes 32-42 |



MISSION READY™ CASUAL BELT

The Mission Ready 1-1/2" Belt fuses the best of casual style and tactical functionality. A genuine leather facing is backed by a durable webbing body, and the internal reinforcement provides a stable sidearm platform. And to make sure you're really ready for any and everything, there's a hidden interior cuff key pocket, too. Imported.

56512 Mission Ready Casual Belt | 1-1/2" width | Black 019, Dark Brown 112 | Even waist sizes 32-42 |



STAY SHARP LEATHER BELT

It's easy to Stay Sharp with this 5.11 Belt. Made of genuine leather with a custom zinc roller buckle, the Stay Sharp fits as well as it looks. Imported.

56513 Stay Sharp Leather Belt | Black 019, Dark Brown 112 | 32-42 Even Sizes |



REVERSIBLE BELT

Change your style as you see fit with the 5.11 reversible belt. Engineered with 1.5" BioThane®, it's durable as all get out. The buckle has minimal parts to reduce the likelihood of parts failure, unlike other reversible buckles. Imported.

56516 Reversible Belt | Black 019, Military Brown 110 | 32-42 even sizes |



1.5" LEATHER BASKETWEAVE BELT

Full-grain leather with Permastiff™ reinforcement, 1-1/2" -wide, and features a rugged I-beam buckle, reinforced stitching and hidden handcuff key pocket. Imported.

59503 Basketweave Leather Belt | 1-1/2" width, basketweave emboss | Black 019 | S-4XL



1.5" LEATHER CASUAL BELT

Full-grain leather with Permastiff™ reinforcement, 1-1/2" -wide, and features a rugged I-beam buckle, reinforced stitching and hidden handcuff key pocket. Imported.

59501 Leather Casual Belt | 1-1/2" width, smooth finish | Black 019, Classic Brown 109 | S-4XL



FIELD WATCH

Inspired by military watches worn by forces around the world, 5.11's Field Watch is built to last, no matter where you find yourself. It's water resistant to 330 feet and features a unidirectional ratcheting bezel. Phosphorescent hands keep civilian time on the main dial, with military time displayed on the inner dial. The bold 44mm case makes a statement

on your wrist, and is ideal for customization on the back. Perfect for active weekends or easy nights out, the Field Watch rolls with a clean, classic military look you can wear every day. Imported.

| **50513 Field Watch** | Black 019, Kangaroo 134 |



KUBATON TACTICAL PEN

With refined styling and precise balance, the Kubaton Tactical Pen feels solid yet nimble in hand. It features a pummel-grip textured, anodized aluminum body, and a twist open pressurized ink cartridge. Get ready to amplify your productivity in the office or in the field. Imported.



DOUBLE DUTY PEN 1.5

With an aerospace-grade aluminum body, spring-steel pocket clip, and medium-sized Fisher Space Pen® cartridge, Double Duty pens are up for the challenge. Imported.

| **50249C Double Duty 1.5 Tactical Pen** | matte black body with knurling | Black 019 |

| **51164 Kubaton Tactical Pen** | Black 019, Sandstone 328, Weathered Orange 366 |



CFX 3.4 NYLON BADGE WALLET

Carry your CFX™ badge in a wallet made just for that purpose. Includes CFX badge from existing templates with department seal and laser etching. Imported.

56325 CFX 3.4 N Badge Wallet | 3" L x 4.5" W, nylon and synthetic leather | Black 019 |



PHANTOM BIFOLD WALLET

The Phantom Bifold Wallet guards your identity and privacy. Made with RFID blocking material, with internal compartments for your CCW or agency ID card, the Phantom is designed like a mini fortress, it features internal card slots, a bill divider in the main compartment and a clear ID window with thumbhole. Imported.

56377 Phantom Bifold Wallet | Black 019 |



BIFOLD WALLET

Built from durable 100% nylon, the Bifold Wallet from 5.11® has everything you need in a wallet and more with its hidden key compartment and ample organization.

56367 Bifold Wallet | Black 019 |



TRACKER BIFOLD WALLET

Picture everything you could possibly need in a wallet and you've got the Tracker Bifold. Load it up with all your everyday carry must-haves and go. The ID window has a thumbhole for quick, easy ID removal. There's plenty of storage for your most important cards, and a backup key pocket ... just in case. The Tracker is constructed with rugged nylon webbing, including a 420D nylon interior. Imported.

56405 Tracker Bifold Wallet | Kryptek Typhoon 099, Kryptek Highlander 159, Multicam 169, Multicam Black 251 |

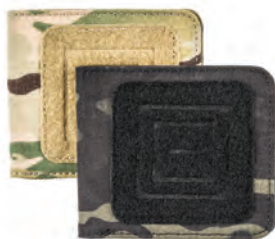

CAMO BIFOLD WALLET

Your VIP cards and cash are sure to fit perfectly in the Camo Bifold Wallet. A bill compartment with a divider houses four cards and bills in the strength of 500D nylon and nylon webbing. The MultiCam® or MultiCam Black™ color choices are complemented by a 5.11® Scope embossed loop patch. Imported.

56544 Camo Bifold Wallet | MultiCam 169, MultiCam Black 251 |



STATUS BIFOLD WALLET

With a branded front loop panel, the Status Bifold lives up to its name. Clearly tactical, it's also utility minded with card pockets, a money compartment and the essential ID pocket. Nylon webbing, 3" x 4.5" Imported.

56466 Status Bifold Wallet | Black 019, Kangaroo 134 | One Size |



STANDBY CARD WALLET

For the card-carrying person in your life, this is the wallet they need. It features pockets to hold up to 15 cards in a comfortable, slim profile. Imported.

| **56464 Standby Card Wallet** | Black 019, MultiCam 169, Ranger Green 186 |



EXCURSION CARD WALLET

Slim, light and comfortable, the Excursion is the perfect wallet for the card-carrying person in your life. Between two pockets, it holds up to 15 cards.

| **56465 Excursion Card Wallet** |



STEEL JACKET MULTI-TOOL WALLET

The Steel Jacket Multi-Tool Wallet is a powerhouse of utility and functionality, with small, medium and large flathead screwdrivers, a pry tool, insets for SIM and memory cards, multi-sized hex bolt wrenches, a 1/4" hex bit socket and yes, even a bottle opener. On the outside, the stainless-steel body shields against RFID intrusion. And don't worry about traveling, this technical marvel meets TSA carry-on regulations.

| **56403 Steel Jacket Multi-Tool Wallet** | Tumbled Steel 988 |



QR CARD WALLET

Walk tall and carry your essentials in a small footprint. Our sleek QR Card Wallet is built with durable yet pliable Hypalon® material with a covert magnet for quick release. Four die-cut pockets easily hold eight cards that no one can access but you. The QR has an RFID blocking material to help keep those cards, and your identity, more secure. You, 1, thieves, 0. Imported.

| **56504 QR Card Wallet** |



CAMO CARD WALLET

Carry your most important cards in the compact, easy to store Camo Wallet. It holds up to 11 cards in tough, tamper-resistant 500D nylon and nylon webbing. Two exterior card slots offer quick access to your ID and the entry card to that all-important side door at work. Imported.

| **56548 Camo Card Wallet** | MultiCam 169, MultiCam Black 251 |



MULTITOOL MONEY CLIP

Made from spring steel, it houses two flat head screwdrivers, a wire stripper, bottle opener, multi-sized bolt drivers and rulers in its innovative design. Imported.

| **56379 Multitool Money Clip** | Black Oxide 927, Tumbled Steel 988 |



ESC RESCUE TOOL

When you see trouble, you act, and the compact ESC Rescue Tool keeps you ready and easy to carry in your pocket or clipped to your visor. Imported.

| 51149 ESC Rescue Tool | Tumbled Steel 988 |



TKO RATCHET KIT

Always Be Ready® to handle field maintenance with the TKO Ratchet Kit and its selection of nine tools. The TKO Ratchet Kit secures to one column of MOLLE/Web with an ABS clip compact for everyday carry.

| 51154 TKO Ratchet Kit | Black 019 |



LE EMT MULTI-TOOL

When seconds count, you need a reliable multi-tool that's always on call but never gets in the way. The 5.11® LE EMT Multi-Tool is designed for optimal efficiency and functionality end-to-end. The Tanto knife blade is designed specifically for piercing hard materials. The seatbelt cutter with a pry bar and a spring-loaded glass breaker can expedite auto extractions and rescues. And with an oxygen wrench, two types of pliers a magnetic hex bit driver, and more, there's almost nothing this multi-tool can't handle. Imported.

| 51150 LE EMT Multi-Tool | Tumbled Steel 988 |

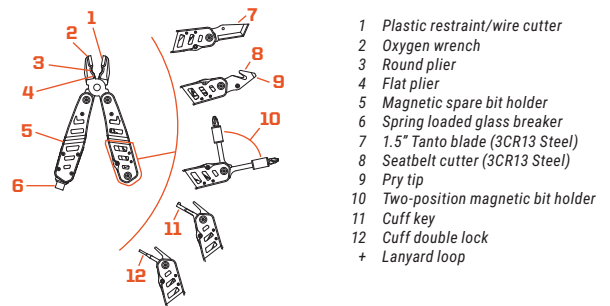



NEW
HARDPOINT M3

- + Attaches securely to load bearing platforms (MOLLE, HEXGRID)
- + Gimped edges for grip
- + Load Rating: 121LB/50KG
- + Stainless steel body
- + Self-closing spring steel wire gates

| **56596 Hardpoint M3** | Black 019, Kangaroo 134 |



NEW
HARDPOINT M2

- + Attaches securely to load bearing platforms (MOLLE, HEXGRID)
- + Gimped edges for grip
- + Load Rating: 99LB/45KG
- + Stainless steel body
- + Self-closing spring steel wire gate

| **56595 Hardpoint M2** | Black 019, Kangaroo 134 |

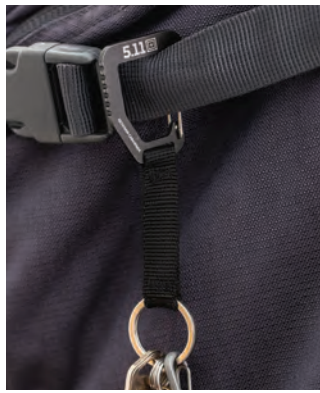

NEW
HARDPOINT MK1

- + Webbing strap with 1" strap pass through
- + Metal split ring for keys
- + Gimped edges for grip
- + Stainless steel body
- + Self-closing spring steel wire gate

| **56597 Hardpoint M1K** | Black 019, Kangaroo 134 |



EDT MULTITOOL

10 tools built into one compact stainless steel tool. Securely clicked into a kydex sheath and easily attached to a belt loop or pack.

- + Stainless steel multitool with sheath & spring clip
- + Standard 6mm hex wrench & flat head screw driver
- + Bottle opener, pry tool & wire stripper
- + Metric & Imperial ruler
- + DIMS: 72mm x 20mm

| **56450 EDT Multitool** | Black 019, Kangaroo 134 |



VTAC® OPERATOR AXE

Designed by Kyle Lamb (Viking Tactics), the Operator Axe brings no-nonsense functionality and performance to the forefront. With 7 mm-thick SCM435 stainless-plate steel (HRC 53-55) and a 21 mm hammer, the axe features metric and standard hex drivers, small and large socket drivers, a 1/4" bit driver, a sheet metal cutter, a pry end with a nail-remover, and a two-piece hard sheath. Pretty much does it all. Imported.

| **51121 Operator Axe** | Black 019 | 4.5" blade, 15" OAL |



CFK FIELD KNIVES

- + Designed in partnership with Gingrich Tactical Innovations
- + Removable FRN handle over full length tang
- + MOLLE/web compatible ambidextrous sheath
- + 435 stainless steel blade (HRC 58-60)

51101 CFK 7 Field Knife | 7" blade, 13" OAL / .28" thick | Sandstone 328 |

51152 CFK 45 | 4" blade, 8.875" OAL / .14" thick | Kangaroo 134 |

FERRO KNIFE

- + Integrated ferro rod w/ strike surface
- + 2" serrated blade, 5" OAL
- + Black oxide coated 420J2 stainless steel blade
- + Thin profile sheath occupies 1 row of MOLLE

| 51145 Ferro Knife | Multi 999 |



HERON KNIFE

- + Integrated ferro rod w/ strike surface
- + 2" blade, 5" OAL
- + Teflon[®] coated stainless steel blade
- + Thin profile sheath occupies 1 row of MOLLE

| 51146 Heron Knife | Black 019 |



TANTO SURGE KNIFE

- + G10 scales over full length tang
- + 4.25" blade, 8.85" OAL
- + Black oxide coated AUS8 blade
- + MOLLE/web compatible ambidextrous sheath

| 51030C Tanto Surge Fixed Knife |



KARAMBIT FOLDER

- + Lock back, full length steel liners
- + 2.87" blade, 6.5" OAL
- + Black oxide coated AUS8 blade
- + Traditional karambit design with retention ring

| 51105 Karambit Folder |



INCEPTOR CURIA KNIFE

- + Frame lock, full length steel liners
- + 2.86" blade, 6.5" OAL
- + Beadblast finish AUS8 blade

| 51141 Inceptor Curia Knife | Black 019, Diplomat 764 |



EDC 2AAA

53383 EDC 2AAA | Cree XP-G3 LED, AAA (2) powered, batteries included, 2M impact | Black 019, Kangaroo 134 |

127 LUMENS
3HR 27M RUNTIME



ANSI FL1	LUMENS	RUNTIME	DISTANCE	CANDELA
HIGH	127	3H 27M	27M	187

EDC PL 2AAA

53380 EDC PL 2AAA | Cree XP-G3 LED, AAA (2) powered, batteries included, 2M impact, IPX-4 | Black 019, Sandstone 328, Weathered Orange 366 |

107 LUMENS
4HR 20M RUNTIME

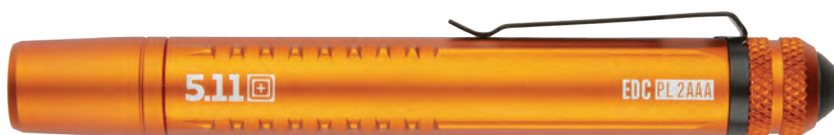

ANSI FL1	LUMENS	RUNTIME	DISTANCE	CANDELA
HIGH OUTPUT	107	4H 20M	26M	172

EDC PL 1AAA

53381 EDC PL 1AAA | Cree XB-D LED, AAA (1) powered, battery included, 2M impact, IPX-4 |

55 LUMENS
3HR 54M RUNTIME



ANSI FL1	LUMENS	RUNTIME	DISTANCE	CANDELA
HIGH OUTPUT	55	3H 45M	23M	137

EDC PLUV 1AAA

53382 EDC PLUV 1AAA | NICHIA™ LED, AAA (1) powered, battery included, 2M impact, IPX-4 | For currency and ID authentication. Additionally can detect hidden fluids, leaks, and troublesome scorpions.

UV
375 NM
6H 40M RUNTIME



ANSI FL1	OUTPUT	RUNTIME
HIGH OUTPUT	Ultraviolet 375nm wavelenth	6H 40M

EDC L2

53385 EDC L2 | Cree XP-G3 LED, CR123 (2) powered, batteries included, 3M impact, IPX-4 | Black 019, Kangaroo 134 |

 **315**
LUMENS

 **3HR 36M**
RUNTIME



ANSI FL1	LUMENS	RUNTIME	DISTANCE	CANDELA
HIGH	315	3H 36M	119M	3528

STATION 2AA

53277 Station 2AA | Cree® XP-G2 LED, AA (2) powered, batteries included, 1M impact, IPX-4 |

 **256**
LUMENS

 **2HR 21M**
RUNTIME



ANSI FL1	LUMENS	RUNTIME	DISTANCE	CANDELA
HIGH OUTPUT	256	2H 21M	119M	3523

STATION 4AA

53278 Station 4AA | Cree® XP-G3 LED, AA (4) powered, batteries included, 1M impact, IPX-4 |

 **508**
LUMENS

 **1HR 33M**
RUNTIME



ANSI FL1	LUMENS	RUNTIME	DISTANCE	CANDELA
HIGH OUTPUT	508	1H 33M	260M	6907

STATION 3D

53279 Station 3D | Cree® XP-L2 LED(3), D (3) powered, batteries not included, 1M impact, IPX-4 |

 **1232**
LUMENS

 **5HR 54M**
RUNTIME



ANSI FL1	LUMENS	RUNTIME	DISTANCE	CANDELA
HIGH	1232	5H 54M	179M	8044
LOW	89	144H 32M	55M	767

RAPID L1

53390 RAPID L1 | Cree® XP-L2 LED, CR123 (1) power, battery incl., 2M impact resistance, IPX7 waterproof and 1M submersible |

290
LUMENS

2H 7M
RUNTIME



ANSI FL1	LUMENS	RUNTIME	DISTANCE	CANDELA
HIGH OUTPUT	290	2H 7M	75M	1416
LOW OUTPUT	19	28H 9M	19M	90
STROBE OUTPUT	290	3H 15M	75M	1416

RAPID L2

53391 RAPID L2 | Cree® XP-L2 LED, CR123 (2) power, batteries incl., 2M impact resistance, IPX7 waterproof and 1M submersible |

523
LUMENS

2H 2M
RUNTIME



ANSI FL1	LUMENS	RUNTIME	DISTANCE	CANDELA
HIGH OUTPUT	523	2H 2M	103M	2643
LOW OUTPUT	61	19H 43M	34M	293
STROBE OUTPUT	523	3H 30M	103M	2643

RAPID PL 1AA

53395 Rapid PL 1AA | Cree XP-G3 LED, Three modes, 1M impact, IP68 dust proof, 2M submersible 1 AA battery (included), upgradeable to 14500 rechargeable power |

202
LUMENS
(UPGRADABLE TO 330)

1H 6M
RUNTIME



ANSI FL1	LUMENS	RUNTIME	DISTANCE	CANDELA
HIGH OUTPUT	190	1H 16M	70M	1250
LOW OUTPUT	55	4H 34M	39M	370
STROBE OUTPUT	190	2H	50M	1250

* 330 lumens when upgraded to 14500 rechargeable Li-Ion power

RAPID PL 2AA

53396 Rapid PL 2AA | Cree XP-G3 LED, Three modes, 1M impact, IP68 dust proof, 2M submersible, 2 AA batteries (included), upgradeable to 14500 rechargeable power |

362
LUMENS
(UPGRADABLE TO 547)

1H 37M
RUNTIME



ANSI FL1	LUMENS	RUNTIME	DISTANCE	CANDELA
HIGH OUTPUT	280	1H 37M	105M	2700
LOW OUTPUT	85	5H 5M	65M	1050
STROBE OUTPUT	280	3H 13M	74M	2700

* 500 lumens when upgraded to 14500 rechargeable Li-Ion power

RESPONSE CR1

549
LUMENS

4H 25M
RUNTIME



53400 Response CR1 | Cree® XP-L2 LED, USB rechargeable cradle with Li-Ion cartridge and CR123 (2) backup cartridge included, 1M impact resistance, IPX4 water resistant |

ANSI FL1*	LUMENS	RUNTIME	DISTANCE	CANDELA
HIGH OUTPUT	549	4H 25M	123M	4397
LOW OUTPUT	45	44H 46M	38M	355
STROBE OUTPUT	549	5H 26M	123M	4397

RESPONSE XR1

1031
LUMENS

1H 37M
RUNTIME



53401 Response XR1 | Cree® XML2-U3 LED, CR123 (2) power upgradeable to rechargeable 18650 (1) power, 1M impact resistance, IP68 dust proof, waterproof and 2M submersible |

ANSI FL1*	LUMENS	RUNTIME	DISTANCE	CANDELA
HIGH OUTPUT	1031	1H 37M	235M	13857
MED OUTPUT	591	1H 57M	179M	8050
LOW OUTPUT	92	8H 25M	65M	1083
STROBE OUTPUT	1031	1H 50M	235M	13857

RESPONSE XR2

2359
LUMENS

2H 25M
RUNTIME



53402 Response XR2 | Cree® XHP50.2 LED, CR123 (4) power upgradeable to rechargeable 18650 (2) power. 1M impact resistance, IP68 dust proof, waterproof and 2M submersible |

ANSI FL1*	LUMENS	RUNTIME	DISTANCE	CANDELA
HIGH OUTPUT	2359	2H	215M	11540
MED OUTPUT	1334	2H 13M	171M	7307
LOW OUTPUT	75	26H 52M	40M	402
STROBE OUTPUT	2359	2H 40M	215M	11540

RESPONSE XR CHARGING KIT

MICRO USB INPUT

USB OUTPUT CHARGE YOUR DEVICE

COMPATIBLE CHARGES LI-ION, NIMH & NICD



53403 Response XR Charger Kit |

- + Dual bay charger
- + Includes two 3400 mAh rechargeable batteries
- + 18650/CR123 transport case
- + Powered by Micro USB for easy travel

- + Use as a powerbank w/ USB output feature
- + Built-in circuit protection
- + Charges NiMH (AAA, AA), Li-Ion (16340, 14500, 18650, 21700)



NEW
RAPID HL 1AA

53415 Rapid HL 1AA | Cree XP-G3 LED, 5 modes, 1M impact, IP54 dust and water resistant, 1 AA battery (included), upgradeable to 14500 rechargeable power | Features an integrated (patent pending) pocket clip under flood light. This allows additional mounting options to gear or apparel | Weight with battery is 4.4oz

| **53415 Rapid HL 1AA Headlamp** | Black 019 |



200 LUMENS



HEADBAND HANDS-FREE



GEAR MOUNT VERSATILITY



POCKET COMPATIBLE

ANSI FL1	LUMENS	RUNTIME	DISTANCE	CANDELA
SPOT LED OUTPUT	200	1H 6M	55M	747
FLOOD (WHITE) COB OUTPUT	22	3H 16M	6M	8

* 330 lumens when upgraded to 14500 rechargeable Li-Ion power



Light rotates within bracket for near or far illumination.



Attaches to web, MOLLE, HEXGRID® and more.



Adjustable elastic band.



Dual-action tailcap buttons.



NEW

RESPONSE HL XR1



1021 LUMENS



RED COB NIGHT VISION



HEADBAND HANDS-FREE



GEAR MOUNT VERSATILITY



POCKET COMPATIBLE

53414 Response HL-XR1 | Cree® XPL-HD LED, 6 modes, CR123 (2) power (included) upgradeable to rechargeable 18650 (1) power, 1M impact resistance, IP54 dust and water resistant | Dual White and Red flood light | Features an integrated (patent pending) pocket clip under flood light. This allows additional mounting options to gear or apparel | Weight with batteries is 6.3oz

ANSI FL1	LUMENS	RUNTIME	DISTANCE	CANDELA
SPOT LED OUTPUT	1021	1H 35M	135M	4548
FLOOD (WHITE) COB OUTPUT	81	6H 20M	9M	20
FLOOD (RED) COB OUTPUT	3	45H	3M	3

| **53414 Response HL XR1** | Black 019 |



Light rotates within bracket for near or far illumination.



Attaches to web, MOLLE, HEXGRID® and more.



Adjustable elastic band.



Dual-action tailcap buttons.



TACLITE 3

Security, comfort, dexterity, warmth, and protection. The Taclite 3 Glove leaves nothing undone. Engineered with elastane and sheepskin leather and a hook & loop-secured cuff closure, this glove is also EN 388: 2016-3011X for abrasion, cut, tear, and puncture resistance. The Taclite 3 covers all the key bases and leaves zero to chance. Imported.

| 59375 Taclite 3 Glove | Black 019 | S-2XL |



STATION GRIP 2

The 5.11 Station Grip Glove is the next level of comfort and safety, with excellent ergonomics, padding, grip, and protection. Suit up and go to work with a glove professionals demand with superior grip and an abrasion resistant palm. EN 388: 2016-2121X rated. The Station glove's got you. Imported.

| 59376 Station Grip 2 Glove | Black 019 | S-2XL |



HIGH ABRASION TAC GLOVE

High abrasion synthetic suede on the palms serves as proper reinforcement to take the brunt of any task. Ring-cut microfiber strips on key fingers give you extra grip where you need it most. And because fit and flexibility are equal priorities, we added notched gussets on the index finger and thumb for maximum movement. EN 388: 2016-4121X rated. Imported.

| 59371 High Abrasion Tac Glove | Black 019, Kangaroo 134 |



COMPETITION SHOOTING GLOVE

The 5.11® Competition Shooting Glove is built for maximum dexterity, breathability and flexibility, with accordion flex points in the fingers, vented palms and a sweat wipe for your thumb. Ironclad® rolled fingertips with conductive microfiber allow you to use your smartphone without removing a glove. EN 388: 2016-2121X rated. Imported.

| 59372 Competition Shooting Glove | Black 019, Kangaroo 134, Ranger Green 186 |



ROPE K9 GLOVE

Engineered and designed with direct input from active K-9 teams and fast roping operations. This glove features a Vibram® anti-friction palm overlay and AX suede fingers for the ultimate protection and durability. The nylon elastane synthetic suede and pinch fingertips promote outstanding comfort and control, no matter how intense your day gets. EN 388: 2016-4121X rated. Imported.

| 59373 Rope K9 Glove | Black 019 | S-2XL |



BATTALION FR GLOVE

It's relied upon by law enforcement officers and special operators around the globe. It offers superior comfort and enhanced dexterity in any operational or tactical setting. The Battalion FR Glove is safety rated for abrasion, cut, tear, puncture, flame, and heat resistance. Don't let them get you down today, or any day. EN 388:2016-3122X, EN407:2004-4231XX rated. Imported.

| 59377 Battalion FR Glove | Black 019 | S-2XL |



HARD TIMES 2 GLOVE

The 5.11 EN 388: 2016-3011XP rated Hard Times 2 Glove provides operators strong, reliable knuckle protection. And the touchscreen leather means you'll never feel disconnected. Even in the harshest mission environments, this glove goes the extra mile to keep your hands safe and responsive. Imported.

| 59379 Hard Times 2 Glove | Black 019, Kangaroo 134 | S-2XL |



FOXTROT FR GLOVE

Engineered for tactical versatility, our Foxtrot FR gloves are built with cut-resistant CarbonX® fabric, strong supple goatskin leather, and reinforced fingertips for exceptional dexterity and durability. And the Foxtrot FR is rated to protect you against the worst of any job, including punctures, tears, cuts and abrasion. Now you're having a good day. EN 388:2016-3011X, EN 407:2004-4111XX rated. Imported.

| 59378 Foxtrot FR Glove | Black 019 | S-2XL |



TAC-CR CUT RESISTANT GLOVE

The TAC-CR Cut Resistant Glove provides 360 degree cut protection while maintaining high dexterity while out on patrol. Protect yourself from scrapes and cuts with this second skin technical knit design. EN388:2016-4X43C, ANSI 105 A3 rated. Imported.

| 59348 Tac-CR Cut Resistant Glove | Black 019 | S-2XL |



CALDUS GLOVE

Thinsulate C100 lining repels wind, moisture and icy temperatures. The patented TacticalTouch™ fingertips allow officers to confidently handle firearms or other duty belt components without removing their gloves. Extended wrist length, neoprene storm cuffs ensure total protection from the elements. EN388:2016-3111X, EN511:2006-11X rated. Imported.

| 59365 Caldus Glove | 019 Black | S-2XL |



EXO.K GEL KNEE PAD

The ideal gear for training and combat in all environments, 5.11's Gel Knee Pad is lightweight, yet extremely robust. It's made with a durable TPE shell and EVA padding with a gel core for ultimate comfort with a TPE overmold for grip and a flat kneeling surface for stability.

58679 EXO.K Gel Knee Pad | Black 019 | One Size



EXO.K1 KNEE PAD

Made specifically to take the brunt of the pressure on your knees the EXO.K1 Knee Pads feature a molded, flexible cap with built-in traction and a flat face for a stable, quiet shooting platform—even on hard surfaces. Beneath the cap is an EVA foam pad for shock absorption and even more protection. A thick woven upper elastic strap and polypropylene lower strap make for a secure fit. Adjustable, silent straps are designed to stay in place without slipping. Stay focused on your mission and not your knees with the EXO.K1 Knee Pads. Imported.

| 50359 EXO.K1 Knee Pad | Black 019, Kangaroo 134, Ranger Green 186 | One Size |



EXO.E1 ELBOW PAD

When you're in full training mode on the range, the last thing you want to think about is skinning or bruising your elbows. With 5.11's new EXO.E1 Elbow Pad, you won't have to. Its molded, flexible cap has built-in traction for stability and an EVA foam pad beneath for shock absorption and added protection. The Elbow Pad features thick woven straps for a secure fit, and adjustable, non-slip straps are designed to stay in place without slipping. Now, focus on getting into any shooting position quickly, safely and comfortably. Imported.

| 50360 EXO.E1 Elbow Pad | Black 019, Kangaroo 134, Ranger Green 186 | One Size |



NEOPRENE KNEE PAD

Ergonomically shaped and compatible with a wide range of 5.11 pants. 6mm thick neoprene backed with a nylon/polyester fabric for easy insertion. Imported.

| 59008 Neoprene Kneepads |



D30 is a patented technology featuring unique molecular properties. In standard conditions its molecules flow freely, but on impact, they lock together to absorb energy and reduce the force transmitted.

ENDO.K INTERNAL KNEE PAD

Ergonomically shaped and compatible with a wide range of 5.11 pants. Made with D30® for impact protection. Imported.

| 56306 ENDO.K Internal Knee Pad |

5.11 BREACHING SYSTEM

ENGINEERED BY 

When you're first on the scene and every second counts, be sure you have the right tools for an effective, expedient entry. Developed in partnership with S.E.T., a world leader in breaching techniques, 5.11®'s Breaching System is designed to quickly defeat a variety of doorway configurations. Our system can be used from outward-facing security doors to car-mounted safety glass. Usable alone or in two-person teams, our patented system, when combined with proven techniques, leads to faster breaches and less exposure for operators. No door is too tough, no window too thick.



HEAVY BREACHING KIT

The ultimate tactical portal entry solution, our Heavy Breaching Kit is the most complete and versatile breaching kit on the market. The kit includes the MultiBreach, MultiPry, MiniRam, EdgeBender, and Heavy Kit Bag, a steel-framed backpack that allows secure transportation and consistent access. The kit contains everything a professional response team needs to quickly and safely breach. 37" height, 52 lbs. loaded weight. Imported, restricted sales.

50268 Heavy Breaching Kit |
56993 Heavy Kit Bag |



TRAINING DOOR

Designed for repeated mechanical and hydraulic breaching, the patented 5.11 Training Door offers extremely sturdy construction and fully customizable settings, including inward/outward swinging options, multiple lock placements, various reinforcement points, and adjustable resistance levels, allowing you to prepare for portal defeat situations on thresholds of any type or composition. Made in USA.

50138 Multi-Purpose Training Door |
50231 Replacement Door Case Edge |
50232 Replacement Door Jamb Edge, 10 qty. |
50344 Training Door Pins, 100 qty. |
50346 Training Door Shims, 100 qty. |



ACTIVE PATROL KIT

Ideally suited for law enforcement and emergency service agencies, the Active Patrol Kit facilitates quick, efficient defeat of a wide range of portals. The kit includes the MultiPry, MultiSledge, and Lite Kit Bag and is effective against standard doors, security doors, and standard and safety glass. Compact and lightweight, the Active Patrol Kit stores easily in your trunk or locker. 13 lbs. loaded weight. Imported, restricted sales.

50267 Active Patrol Breaching Kit |
56992 Lite Kit Bag |



CARRAKE

The CarRake allows swift, safe breach and clearance of laminated, security, privacy, and other glass types for expedited vehicular rescue. Utilizes a weighted head for proper penetration, a curved rake to remove glass shards, and an integrated seatbelt cutter. Weight: 3 lbs. Length: 19.5". Made in USA, restricted sales.

| 50334 CarRake |



EDGEBENDER 2.0

The EdgeBender's vice jaws slip behind mounted security plates, and the T-handle applies even, silent pressure to create an attack gap, allowing the use of leverage-based tools, like the MultiBreacher and MultiPry. Weight: 6 lbs. Length: 17.5". Made in USA, restricted sales.

| 50527 EdgeBender 2.0 |

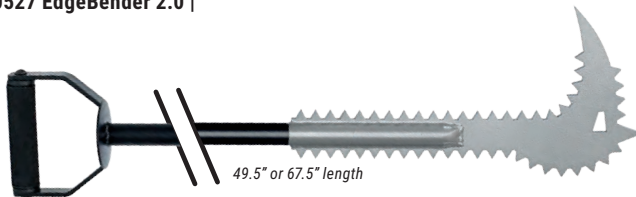

49.5" or 67.5" length

GRYPHON BREAK 'N RAKE

The Gryphon Break 'N Rake provides fast, safe breach of laminated, security, privacy, and other glass types commonly used in automobiles and buildings. A protective D-ring and rubber grip handle offers excellent grip and control while sawing, and the serrated rake excels as a blunt force tool and shard rake. 49.5" and 67.5" versions available. Made in USA. Restricted sales.

| 50335 Gryphon Break 'N Rake-Extended | Weight: 9.5 lbs (4.3kg), 67.5" (171 cm) length |
 | 50336 Gryphon Break 'N Rake-Standard | Weight 8 lbs (3.6kg), 49.5" (126 cm) length |



MINIRAM

A compact, high-impact force tool. Weighted and balanced for use in tight quarters, the MiniRam features knuckle guards, non-slip grips, and a convex head to ensure complete force transmission regardless of contact angle. Weight: 23.2 lbs. Length: 17.5". Restricted sales.

| 50091 MiniRam |



MULTIPRY

The MultiPry features a strengthened pry blade and non-slip Traction Teeth for superior penetration and maximum strength against hardened security portals. The handle shaft ends in a traditional pry bar. Weight: 5.4 lbs. Length: 28". Restricted sales.

| 50093 MultiPry |



MULTIBREACHER

A full-sized multi-function pry bar that provides effective entry against fortified security portals. Integrated TractionTeeth along the strengthened pry blade minimize slippage and maximize displacement, and the handle shaft ends in a traditional pry bar. Patented. Weight: 8.4 lbs. Length: 32". Restricted sales.

| 50094 MultiBreacher |



MULTISLEDGE

5.11's MultiSledge offers 4 tools in 1: A multi-directional, hardened hammer, a ram, a multi-purpose saw/rake for breaking and clearing glass shards, and a traditional pry bar. This all-around tool provides exceptional utility in a wide variety of breaching situations. Patented. Weight: 6.8 lbs. Length: 27". Restricted sales.

| 50092 MultiSledge |



MEDIUM RAM

Engineered to provide strong, reliable kinetic breaching, the Medium Ram is suitable for use by 1 or 2 breachers. Featuring high-grade steel construction, a convex head for accurate force delivery, and sure-grip handles and ballasts for balance and control. Weight: 37 lbs. Length: 28.5". Width: 10". Height: 7". Made in USA, restricted sales.

| 50358 Medium Ram |

LOAD BEARING GEAR

From mission-specific pouches to cavernous gear rollers, 5.11 has a solution (or two) for whatever you need to haul.

On patrol in our GE07® camo pattern in 5.11 Stryke® TDUs and TacTec® Plate Carriers.



ADVANCED CONCEALMENT

MACRO DISRUPTION

By networking large regions of color with shape, GEO7 breaks up the profile of the human form and increases the visual delay in identifying the human form beginning at 10 meters, providing the operator a tactical time advantage.

MICRO DISRUPTION

By networking small regions of color with shape, GEO7 breaks up the details within the human form and increases the visual delay in identifying the human form inside of 25 meters, providing the operator an additional tactical time advantage.

DISRUPTIVE MIMETIC COLORATION

GEO7 color palettes are extracted from target environments and refined to expand their performance in those environments. These colors are combined with both macro and micro disruption for performance in the field.

SCALABLE CONCEALMENT

Our combination of macro and micro disruption fields and color palettes work in tandem across light conditions, distance and environments to gain the operator a significant advantage

MATHEMATICAL EDGE

GEO7 has been designed using both fractal and chaos mathematical principals. These principals fuel the visual biases found in the natural world. This approach leads to the color and disruption fields which make GEO7 so effective.

GEO7™ ITEMS

Duty Rain Shell	85
5.11 Stryke® TDU Uniforms	138
TDU Uniforms	144
Hats	156
TacTec™ Plate Carrier	220
Pouches	228
AMP24™ Backpack	237

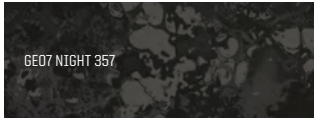

GEO7 NIGHT 357



GEO7 TERRAIN 865



**GEO7 IS AN EXCLUSIVE PATTERN
FROM 5.11 AND PRODUCED IN
PARTNERSHIP WITH VEIL CAMO.**



ALL MISSIONS PLATE CARRIER

Ready for any operation, the All Missions Plate Carrier comes equipped with a full range of components that you can tailor to suit your needs. Build out the carrier with a “Slick” low-vis and low-profile configuration, or go with a “Standard” setup using our patented multi-angle HEXGRID® mounting system. When a maximum loadout of equipment, ammo and armor is required, the All Missions Plate Carrier easily transforms to a layered “Raid” configuration. Imported.

- + Front and rear plate bags which are compatible with any ESAPI plate. Plates are secured internally with 5.11’s patent-pending shock absorbing suspension system. Rear plate bag features our GrabDrag handle for emergency exfil.
- + HEXGRID® 12x9 Gear Set™ and HEXGRID® 12x9 Gear Set™ with Pouch.
- + Three sets of waist straps/cummerbunds allow you to customize the carrier’s capacity and fit.
- + Webbing waist straps for a low-vis profile. Inner stretch cummerbunds can be switched side-to-side. Outer cummerbund with HEXGRID® multi-angle load-bearing platform.
- + Kangaroo pouch Adapter to securely mount three AR magazines on the HEXGRID® 12x9 Gear Set™ with Pouch or the built-in kangaroo pouch on the front plate bag.

59587 All Missions Plate Carrier | Black 019, Kangaroo 134, Ranger Green 186 | S/M, L/XL |

90149 All Missions PC Extender | Black 019, Kangaroo 134, Ranger Green 186 | 2XL-4XL |

BLACK 019

KANGAROO 134

RANGER GRN 186





ALL MISSIONS RIG

On patrol or on a mission, the All Missions Rig is the ultimate customizable storage expansion for your critical gear. The Rig features a harness, a 9" x 9" loop panel to mount a 5.11® Gear Set™, an adjustable waist strap and two adjustable panel straps for configuring things your way. The All Missions Rig can also host the AMPC Pack or MOLLE attachment pouches on the back side. Low-pro, super-durable Hypalon straps allow you to wear a backpack on top of the Rig. Whether you're defending freedom or protecting the community, this is the ideal solution for carrying your essential gear. Imported.

- + Mount a 9 x 9 Gear Set™ on the front with up to 8" of vertical adjustment
- + Mount AMPC Pack or MOLLE attachment pouches on back
- + Low profile Hypalon straps allow for wearing a backpack on top
- + Includes harness, 9" x 9" loop panel for Gear Set™ with multiple strap attachment locations, adjustable waist strap, two adjustable panel straps

56492 All Missions Rig | Black 019, Kangaroo 134, Ranger Green 186 |



Front platform allows up to 8" of vertical adjustment for high to low placement of your Gear Set™.

AMPC Pack (56493) can be attached to the rear platform of the All Missions Rig. The All Missions Rig can also be worn beneath a backpack.

BLACK 019

KANGAROO 134

RANGER GRN 186



DOUBLE DEPLOY GEAR SET™

- + Two individually detachable pouches
- + Stretch woven pouch with side zipper

56399 Double Deploy Gear Set | Tungsten 014, Black 019, Kangaroo 134, Ranger Green 186 |

TUNGSTEN 014

BLACK 019

KANGAROO 134

RANGER GRN 186



LASER-CUT MOLLE™

- + Two loop strips for name tape
- + Laser-cut MOLLE with top two rows of loop

56432 Laser-Cut MOLLE Gear Set™ | Tungsten 014, Black 019, Kangaroo 134, Ranger Green 186 |

TUNGSTEN 014

BLACK 019

KANGAROO 134

RANGER GRN 186

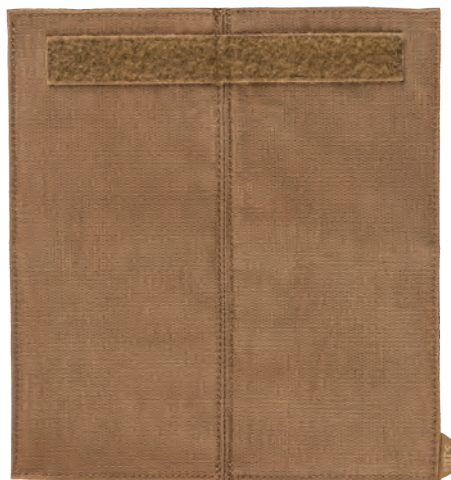

NEW

AMP COVERT PANEL

- + 5.11's signature Center Line™ design
- + Covers front loop panel of AMP™ bags for low-vis/slick appearance for mission-ready versatility
- + Loop strip for name tape or flap closure

56553 AMP Covert Panel | Tungsten 014, Black 019, Kangaroo 134, Ranger Green 186 |

TUNGSTEN 014

BLACK 019

KANGAROO 134

RANGER GRN 186



HEXGRID® 9x9 GEAR SET™

- + Patented HEXGRID® multi-angle load-bearing platform
- + Bottom access for easy weaving

56398 HEXGRID 9x9 Gear Set | Tungsten 014, Black 019, Kangaroo 134, Ranger Green 186 |

TUNGSTEN 014

BLACK 019

KANGAROO 134

RANGER GRN 186



HELMET/SHOVE-IT GEAR SET™

- + Holds ballistic & bump helmets
- + Alternative shove-it for misc. cargo

56491 Helmet/Shove-It Gear Set™ | Tungsten 014, Black 019, Kangaroo 134, Ranger Green 186 |

TUNGSTEN 014

BLACK 019

KANGAROO 134

RANGER GRN 186



HEXGRID® 12x9 GEAR SET™

- + Patented HEXGRID® multi-angle load-bearing platform
- + Bottom access for easy weaving

56415 HEXGRID 12x9 Gear Set | Black 019, Kangaroo 134, Ranger Green 186 |

56494 HEXGRID 12x9 Gear Set with Pouch | Black 019, Kangaroo 134, Ranger Green 186 |

BLACK 019

KANGAROO 134

RANGER GRN 186





2 BANGER GEAR SET™

- + Two accessory/utility compartments
- + Rear compartment for Two AR magazines

56400 2 Banger Gear Set | Tungsten 014, Black 019, Kangaroo 134, Ranger Green 186 |



ADMIN GEAR SET™

- + Foldout admin pouch with organization panels

56401 Admin Gear Set | Tungsten 014, Black 019, Kangaroo 134, Ranger Green 186 |





MED POUCH GEAR SET™

- + Three tier fold-out organization system
- + Dual main zipper opening

| 56407 Med Pouch Gear Set | Black 019 |



NEW

UTILITY 9X9 GEAR SET™

The Utility 9x9 Gear Set™ expands your organization options with 249 cu. in. of highly engineered cargo space. Two rugged primary compartments and a front zippered pocket keep your gear separated and in place, while a forward tilting tray front compartment wall provides easy access. The main compartment contains a file system with elastic bands, slip pockets and a divider. A rear compartment is equipped with elastic bands for magazines or other accessories. Imported.

- + 9" H x 8.5" L x 3.25" D
- + 5.11's signature Centerline™ design

| 56518 Utility 9x9 Gear Set | Tungsten 014, Black 019, Kangaroo 134, Ranger Green 186 |

TUNGSTEN 014

BLACK 019

KANGAROO 134

RANGER GRN 186



Attaches to AMPC Plate Carrier or any Gear Set™ Compatible platform.



Serious gear organization and a front platform with a rigid (removable) insert.



TACTEC™ PLATE CARRIER



Our patented TacTec® Plate Carrier is the most comfortable plate carrier you will ever wear—period. Constructed from rugged, lightweight 500D nylon, the TacTec Plate Carrier features padded yoke shoulder straps, front and back padded panels with built-in airflow channels and perforated mesh. It's secure, breathable, functional and provides maximum range of motion. Sized to hold two ballistic armor plates (medium/large), with a low-profile grab-drag handle and single-handed quick-release cable escape system, the TacTec Plate Carrier is always ready for duty. Side panels are available. MultiCam version features slight design changes. Imported.

56100 TacTec Plate Carrier | Black 019, Storm 092, Tac OD 188, Sandstone 328, Dark Navy 724 |

56385 TacTec MultiCam® Plate Carrier | Multicam 169 | 1 SZ |

56100G7 GE07™ TacTec Plate Carrier | Night 357, Terrain 865 |

56274 TacTec Plate Carrier Side Panels | Black 019, Storm 092, Tac OD 188, Sandstone 328, Dark Navy 724 |

90144 TacTec Plate Carrier Extender | Black 019, Storm 092, Kangaroo 134, Tac OD 188, Sandstone 328, Dark Navy 724 |

BLACK 019

STORM 092

MULTICAM 169

TAC OD 188

SANDSTONE 328

GE07 NIGHT 357

DARK NAVY 724

GE07 TERRAIN 865

**NEW**

PRIME PLATE CARRIER

Fully scalable and modular, the Prime Plate Carrier offers outstanding versatility and mission-ready adaptability. Go from low-vis slick to a tactical loadout with our Gear Set™ attachments, our Flex Hook Adapters (56480) or any hook and loop attachment. Adjustable shoulder straps are low-profile and can be adjusted on the go. The interior of carrier is padded for comfort and breathability. Includes two adapters for AMPC Pack attachment on rear of carrier. Imported.

56546 Prime Plate Carrier | Black 019, Kangaroo 134, Ranger Green 186 | S/M, L, XL |

BLACK 019

KANGAROO 134

RANGER GRN 186



S/M sized for a medium ESAPI plate and includes strap for mounting a small ESAPI plate.

L sized for a large ESAPI plate and includes a strap for mounting a small- or medium-sized ESAPI plate.

XL is universal plate sizing and accommodates any size of ESAPI plate. Includes straps for mounting small, medium, large or extra-large plates.



TACLITE PLATE CARRIER

Superior protective capability in a lightweight, low-profile platform. Built from durable 500D nylon, featuring adjustable yoke shoulder straps and elastic waist straps for a snug, secure fit, the Taclite Plate Carrier is comfortable and effective. Sized for standard armor plates, it also offers a grab-drag handle for rapid exfiltration. The front web platform is MOLLE- and SlickStick®-compatible, and the back side includes a large patch panel. Imported.

| **56166 Taclite Plate Carrier** | Black 019 | One Size |



LBE VEST

This is the best LBE system on the market, bar none. Constructed of a durable, stiffened nylon mesh that provides outstanding structure while remaining lightweight and breathable, the LBE Vest features hidden utility pockets and a hydration pocket. Girth and length adjustments ensure a perfect fit. There's a hidden grab-drag handle for emergency exfiltration, and naturally, this system is MOLLE- and 5.11 SlickStick®-compatible. Imported.

| **58631 LBE Vest** | Black 019 | Reg, 2XL+, 4XL (4XL





TACTEC® CHEST RIG

Constructed from durable nylon and Duraflex® hardware, the TacTec Chest Rig is lightweight and configurable with a Rhodesian-style or H-frame fit. Featuring six front-facing compartments, twin outside compartments suitable for 500ml water bottles and a rear utility pocket, the rig offers an interior web platform for backup storage. The whole system is MOLLE- and SlickStick® compatible, and magazines can be mounted via nylon cover or bungee retention. Imported.

56061 TacTec Chest Rig | Black 019, Tac OD 188, Sandstone 328 | One Size |

VTAC® COMBAT BELT & THIGH RIG

Our VTAC® Combat Belt is engineered from tough 500D nylon and breathable 3D spacer mesh. It features an ergonomic shape that spreads the load and reduces hip pressure. With web platforms to attach your holster, pouches and everything else, add a 5.11 belt of your choice and you're ready to go. Tether the VTAC® harness to your Combat Belt or add a Thigh Rig for drop-down access to your sidearm or other tactical gear. Imported.

58642 VTAC® Combat Belt | Black 019, Sandstone 328 | S/M, L/XL, 2XL/3XL (2XL-3XL) |

58633 Thigh Rig | Black 019 |

90143 Thigh Rig Belt Strap Attachment | Black 019 |



VTAC® TWO-POINT SLINGS



The VTAC Two-Point Sling provides superior flexibility and security in tactical situations. Quick-adjust action allows you to rapidly transition from strong-side to support-side, or to pull your firearm close to your chest or back in close quarters. Heavy-duty nylon construction and high-impact clips ensure durability. Imported.

59123 Two-Point Padded Sling | Black 019, Sandstone 328 |

59120 Two-Point Sling | Black 019 |



VTAC® SINGLE-POINT SLING



Crafted from durable 500D nylon for maximum resilience the VTAC® Single-Point Sling supports a standard-sized rifle or submachine gun. The Single-Point Sling is ideal for individuals who prefer a single-point adjust, quick-release snap shackle and an assortment of attachment options. Imported.

54000 Bungee Single-Point Sling | Black 019 |





COVERT INSERT

Organization yields efficiency. And efficiency makes for an exceptional operator. Keep your pouches and gear in order, or convert any bag or pack into an instant go-bag. The Covert Insert is available in two sizes (15" x 10" or 19" x 12") and features a rigid panel, configurable handle, and a web panel that runs horizontally (front) and vertically (back) for maximum functionality and flexibility. The panels are MOLLE-, SlickStick®, and TacTec-compatible, allowing you to tailor an easy-go loadout. There's no better way to manage your tools of the trade. Imported.

56280 Small Covert Insert | Black 019, Sandstone 328 | 15.25" x 10" |

56281 Large Covert Insert | Black 019, Sandstone 328 | 19" x 12.25" |



Any 5.11 SlickStick® pouch, MOLLE or WEB gear pouch can be attached to our new Covert Inserts, making it easy to transfer specialized equipment or daily essentials between larger bags. Pouches pictured available separately.

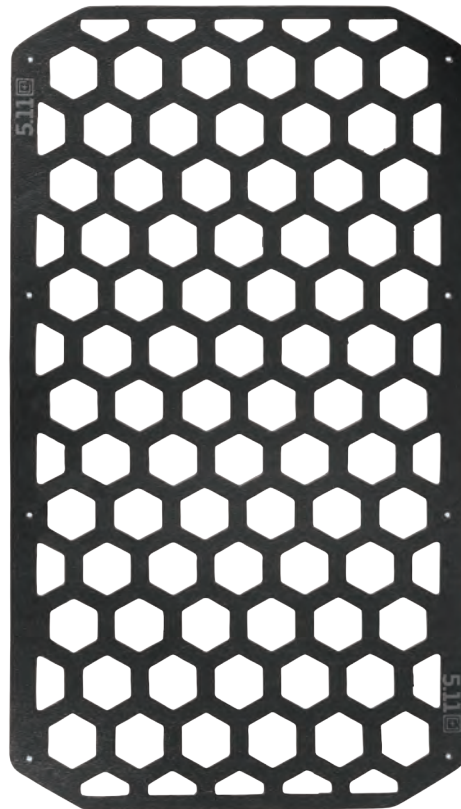

HEXGRID® INSERT

Organization problem? Say hello to 5.11's patented HEXGRID® multi-angle load bearing system. Removable webbing straps allow for Gear Set™ attachment, making any backpack or bag Gear Set™ compatible. So, when your shift gets switched or your mission changes, you'll be ready. Imported.

- + Removable board for mounting gear in a backpack
- + Included webbing straps for attachment of any Gear Set™
- + Holes on perimeter for routing cordage / bungee
- + Polyethylene
- + DIMS: 17.0" x 9.0", 2.5mm thick

| **56434 HEXGRID® Insert** | Black 019 |





NEW
VEHICLE READY HEXGRID® PLATFORMS

Commuting, overlanding or pulling security for an NGO convoy across the Djado Plateau in a gun truck, our HEXGRID Platforms will improve the journey. The panel features a full loop face and provides placement for an assortment of hook and loop and Gear Set™ attachments.

The Seat Platform features an adjustable headrest strap and removable side seat straps. A quick-release padded seat wedge provides secure attachment to either the front or rear of a driver or passenger seat. The Seat Platform comes packaged in a removable and reusable hook and loop attachment. A mesh bag is included.

The Headrest Platform can be attached to the front or back of a headrest and features the same loop face HEXGRID functionality as the Seat Platform, providing a ready place for a flashlight, FAK and other essentials you need within easy reach. Imported.

56520 Vehicle Ready HEXGRID® Headrest Platform | 5.8" H x 6.6" W | Black 019 |

56519 Vehicle Ready HEXGRID® Seat Platform | 19" H x 12" W | Black 019 |



FLEX-HT™ POUCHES

The Flex-HT™ mounting system offers maximum versatility and cross-platform mounting options. The ½" webbing ladder provides more mounting versatility than normal webbing and the ¾" width straps make it easier to attach.



FLEX SINGLE PISTOL MAGAZINE POUCH

- + Built-in retention insert to secure magazine without cover/bungee
- + Double layer N500D & webbing on front/bottom for extra durability
- + Drain hole on bottom panel

56426 Flex Single Pistol Mag Pouch | 1 Flex Hook Adapter Included | Black 019, Kangaroo 134, Ranger Green 186 |



FLEX DOUBLE PISTOL MAGAZINE POUCH

- + Built-in retention insert to secure magazine without cover/bungee
- + Double layer N500D & webbing on front/bottom for extra durability
- + Drain hole on bottom panel

56425 Flex Double Pistol Mag Pouch | 2 Flex Hook Adapters Included | Black 019, Kangaroo 134, Ranger Green 186 |



FLEX SINGLE AR MAGAZINE POUCH

- + Built-in retention insert to secure magazine without cover/bungee
- + Double layer N500D & webbing on front/bottom for extra durability
- + Drain hole on bottom panel

56424 Flex Single AR Mag Pouch | 2 Flex Hook Adapters Included | Black 019, Kangaroo 134, Ranger Green 186 |



FLEX DOUBLE AR MAGAZINE POUCH

- + Built-in retention insert to secure magazine without cover/bungee
- + Double layer N500D & webbing on front/bottom for extra durability
- + Drain hole on bottom panel

56423 Flex Double AR Mag Pouch | 2 Flex Hook Adapters Included | Black 019, Kangaroo 134, Ranger Green 186 |



FLEX ADMIN POUCH

- + Laser cut platform on front & zipper closure
- + Internal loop platform, slip pockets & elastic bandoliers
- + Adjustable bungee cord for securing a phone or accessories

56429 Flex Admin Pouch | Black 019, Kangaroo 134, Ranger Green 186 |



FLEX RADIO POUCH

- + 3mm bungee cord & magnetic Fidlock® adjuster for retention
- + Hypalon pull tab with loop back to secure position on pouch
- + Flex-HT™ mounting system with two Flex Hook Adapters

56428 Flex Radio Pouch | Black 019, Kangaroo 134, Ranger Green 186 |



FLEX MEDIUM GP POUCH

- + Stretch woven front pocket
- + Internal mesh pocket
- + Two internal slip pockets

56427 Flex Medium GP Pouch | Black 019, Kangaroo 134, Ranger Green 186 |



FLEX MED POUCH

- + External seam binding construction for maximum internal volume
- + Pull tab for quick opening and dual zipper webbing for quick closure
- + 44 cubic inch / 0.7-liter total capacity / 7.0"H x 2.5"L x 2.5"D

56489 Flex Med Pouch | Black 019, Kangaroo 134, Ranger Green 186 |



FLEX VERTICAL GP POUCH

- + Padded pouch with expandable drop bottom (5.75" to 9")
- + Fits 32-oz. water bottle
- + Top zipper closure with tension lock webbing pulls

56490 Flex Vertical GP Pouch | Black 019, Kangaroo 134, Ranger Green 186 |



FLEX RESCUE POUCH

- + Compatible with two doses of NARCAN® nasal spray or Naloxone Hydrochloride injection (not included)
- + Padded pouch with hook & loop closure
- + 5.375 cubic inch / 0.4-liter total capacity / 5.375"H x 3.125"L x 1.75"D

56501 Flex Rescue Pouch | Black 019 |



FLEX DROP POUCH

- + Drop pouch with zippered storage capability
- + Paracord/toggle latch
- + Elastic bandoliers for attachment of accessories

56430 Flex Drop Pouch | Black 019, Kangaroo 134, Ranger Green 186 |



FLEX LOOP PANEL

- + Converts any MOLLE platform to a 4.5" x 4.5" loop panel

56481 Flex Loop Panel | Black 019, Kangaroo 134, Ranger Green 186 |



FLEX HOOK ADAPTER

- + Converts any MOLLE/WEB pouch to a hook attachment
- + Two Flex Hook Adapters included

56480 Flex Hook Adapter | Black 019, Kangaroo 134, Ranger Green 186 |



56154 Pistol Single Bungee/Cover | Black 019, Tac OD 188, Sandstone 328 |



56155 Double Pistol Bungee/Cover | Black 019, Storm 092, Tac OD 188, Sandstone 328, Dark Navy 724 |



56386 Multicam® Double Pistol Bungee/Cover | Multicam 169 |



56155G7 GE07 Double Pistol Bungee/Cover | Night 357, Terrain 865 |



56156 AR Single Bungee/Cover | Black 019, Tac OD 188, Sandstone 328 |



56157 AR Double Bungee/Cover | Black 019, Storm 092, Tac OD 188, Sandstone 328, Dark Navy 724 |



56387 Multicam® AR Double Bungee/Cover | Multicam 169 |



56157G7 GE07 AR Double Bungee/Cover | Night 357, Terrain 865 |



56158 AK Single Bungee/Cover | Black 019 |



56159 AK Double Bungee/Cover | Black 019, Sandstone 328 |



56160 MP5 Single Bungee/Cover | Black 019 |



56161 MP5 Double Bungee/Cover | Black 019 |



56162 Rigid Cuff Case | Black 019 |



58721 Cuff Case | Black 019 |



56030 C5 Case | Black 019 | Smartphone/PDA/GPS |



58703 Large Drop Pouch™ | Black 019, Tac OD 188, Sandstone 328 | 10"H x 6"D open |



58718 Radio Pouch | Black 019, Storm 092, Flat Dark Earth 131, Tac OD 188, Sandstone 328, Dark Navy 724 |



56388 Multicam® Radio Pouch | Multicam 169 |



58718G7 GE07 Radio Pouch | Night 357, Terrain 865 |



58722 H2O Carrier | Black 019, Flat Dark Earth 131, Tac OD 188 |



58719 Strobe/GPS Pouch | Black 019 |



56031 Flash Bang Pouch | Black 019, Tac OD 188, Sandstone 328 |



56164 Single 40mm Grenade Pouch | Black 019 |



56250 Double 40mm Grenade Pouch | Black 019 |



58713 6.6 Pouch | Black 019, Storm 092, Flat Dark Earth 131, Tac OD 188, Dark Navy 724 |



56389 Multicam® 6.6 Pouch | Multicam 169 |



58713G7 GE07 6.6 Pouch | Night 357, Terrain 865 |



58714 6.6 Padded Pouch | Black 019, Flat Dark Earth 131, Sandstone 328 |



58717 6.10 Pouch | Black 019, Flat Dark Earth 131, Tac OD 188, Sandstone 328 |



58716 10.6 Pouch | Black 019, Flat Dark Earth 131 |



58715 6.6 Med Pouch | Black 019, Storm 092, Flat Dark Earth 131, Tac OD 188, Sandstone 328 |



56096 3.6 Med Kit | Black 019, Tac OD 188, Sandstone 328 |



56122 5 Round Shotgun Bandolier | Black 019, Sandstone 328 |



56165 12 Round Shotgun Carrier | Black 019 |



56119 Shotgun Ammo Pouch | Black 019, Tac OD 188, Sandstone 328 |



50058 Disposable Glove Pouch | Black 019, Sandstone 328 |



56121 Light-Write Patch | Black 019, Sandstone 328 |



58780 LBE Holster | Black 019 |



58828 LBE Compact RH | Black 019 |

58829 LBE Compact LH | Black 019 |



59002 Holster Pouch (hook and loop) | Black 019 |



56318 TacTec Holster 2.0 | Black 019 |



58830 TacTec Flex Kit |

SIERRA BRAVO

2" and 2.25" duty belts and pouches built for durability and stability without adding unnecessary weight to your duty belt.





SIERRA BRAVO DUTY BELT SYSTEM

A belt shouldn't weigh you down. It shouldn't constantly remind you that you're wearing a rig. A duty belt should just quietly, intuitively, effectively equip you for the situation at hand. Constructed from high-tensile 1680D nylon, the Sierra Bravo system features a water-resistant coating to guard against sweat, rain, and other elements. Our patent pending Slim-Lock buckle is only 1.7" wide; maximizing the real estate on your belt. The kit includes the main belt, inner belt, and 4 keepers with dual-retention hook-and-loop/snap closures. Available in 2" and 2.25" widths. Imported.

59505 Sierra Bravo 2" Belt | Black 019 | S-4XL (2XL+)

59506 Sierra Bravo Plus 2.25" Belt | Black 019 | S-4XL (2XL)



56244 Baton Loop | Black 019 |

56322 SB Expandable Baton Pouch | 1.25" dia | Black 019 |

56245 SB DbI Pistol Mg Pouch | 019 Black |

56246 SB Handcuff Cuff Pouch | 019 Black |

56247 Radio Pouch | Black 019 |

56479 Flashlight Holder | 1" dia | Black 019 |

56257 SB Flashlight Holder | 1.25" dia | Black 019 |

56243 Gas/Mace/Light Pouch | 1.5" dia | Black 019 |

56321 SB Mace/Mk4 Flashlight Pouch | 1.5" dia | Black 019 |

56258 Latex Glove Pouch | Black 019 |

59507 SB Buckle | 019 Black |

59508 SB Keepers 2" | 019 Black |

56328 SB Keepers 2.25" | 019 Black |



"...after wearing them for a few days I could not believe how comfortable the system was. The plates lock your gear into place... and seem to push your duty belt in and up, making your gear seem weightless."

- NTOA Reviewer, Connecticut

ZERO-G LOAD-BEARING PLATES

Research-Driven Design – 5.11 Zero-G Plates™ distribute the load of duty equipment correctly by utilizing the body's natural-weight bearing structure. Specifically, the Zero-G Plate positions the weight of your duty belt properly on your hip and through to your femur.

Promotes A Spine-Safe Posture – Unlike the traditional front-load duty belt, which increases forward pressure on your lumbar spine and can prevent abdominal muscles from properly firing, Zero-G Plates promote correct posture through their ergonomic shape and precise application.

Low-Profile Appearance – Zero-G Plates maintain a neat, clean, and professional appearance with a minimal profile. Made from a non-reflective carbon-fiber material and overmolded for comfort, the plates are durable and easy to use. The inner face of the Zero-G plate features a large loop-sided panel that securely adheres to your inner hook-sided liner belt.

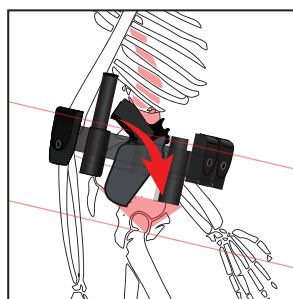

Standard duty belt systems typically shift the weight of the belt forward over the femur, forcing the lower back to work harder and absorb undue stress.

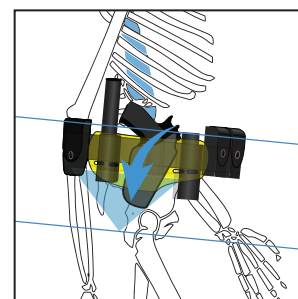

Zero-G places your duty belt in a more neutral position, preventing it from tilting forward while distributing the weight for long-term comfort.

59509 Zero-G Plates | Black 019

90110 Zero-G Attachment Loop

ALL MISSIONS

Equip your backpack or plate carrier to suit your mission with our versatile and adaptable Gear Set Pouches.

1. SELECT YOUR GEAR SET(S)

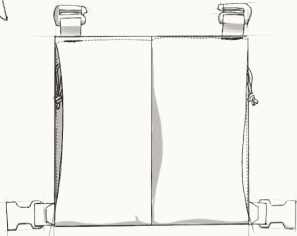

DOUBLE DEPLOY GEAR SET
(TWO REMOVABLE POCKETS)

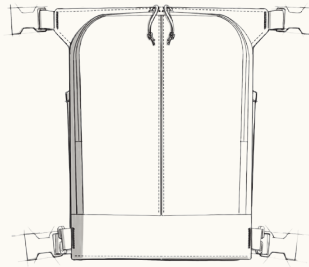

HELMET/SHOVE-IT
GEAR SET



ADMIN GEAR SET
(STAY ORGANIZED)

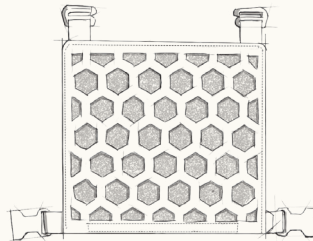

HEXGRID 9X9 GEAR SET
(12X9 ALSO AVAILABLE)



2 BANGER GEAR SET
(HOLDS TWO AR MAGS)

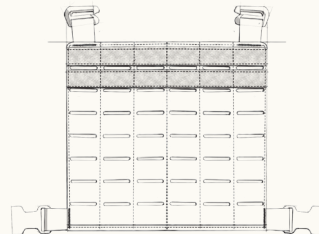

LASER-CUT
MOLLE GEAR SET



UTILITY 9X9 GEAR SET
(WORK PLATFORM)

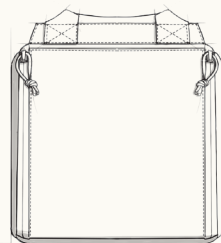

MED POUCH GEAR SET
(FOLD-OUT ORGANIZATION)

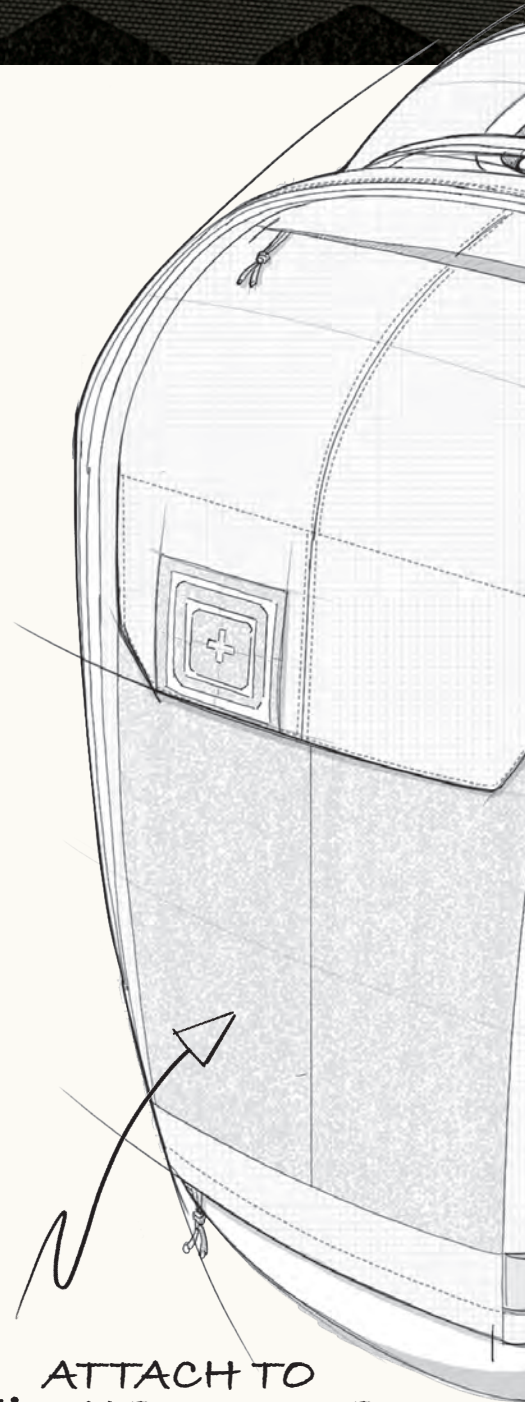

2. ATTACH TO THE OUTSIDE...

GEAR SETS ARE BACK ON PAGE 216

PLATFORM

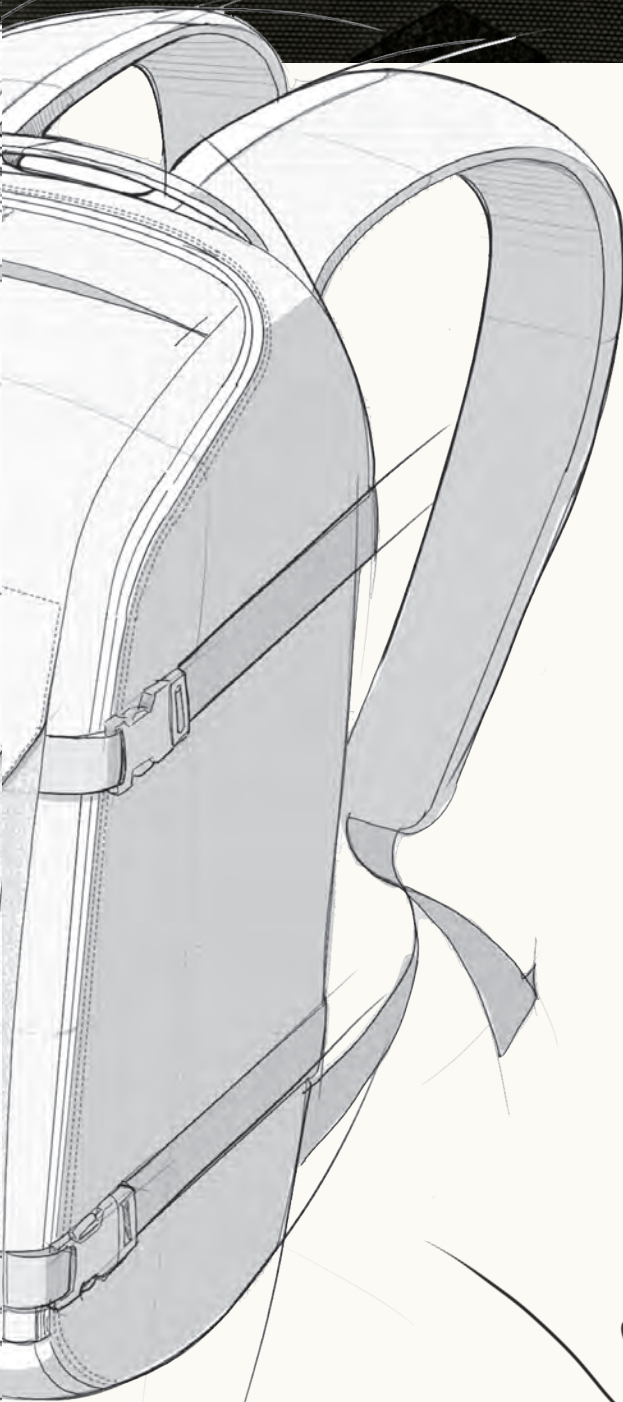

...OR INSIDE

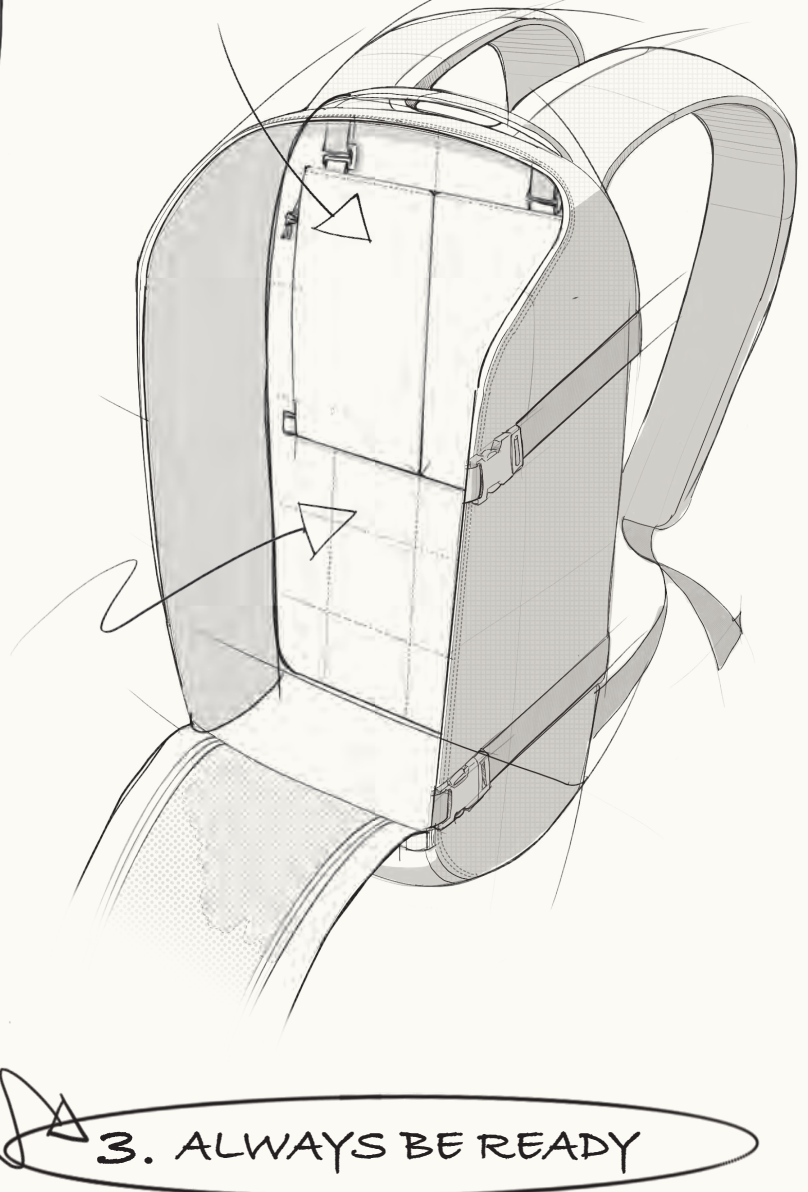

GEAR SETS ALSO WORK WITH:
ALL MISSIONS PLATE CARRIER, P 214
ALL MISSIONS RIG, P 215
PRIME PLATE CARRIER, P 221

5.11 



AMPC PACK

16L

The tough, yet lightweight 5.11® AMPC Pack takes tactical utility, versatility and comfort to the next level. Perfect for carrying hydration or extra cargo, the AMPC Pack can mount directly to the backs of our All Missions, TacTec® and Prime Plate Carriers. It also integrates with the Helmet/Shove-It Gear Set™. The AMPC Pack is Gear Set™ compatible inside and out and comes with the 5.11 HEXGRID® 9x9 Gear Set™. Internal elastic and stitched pleats provide active compression for a low profile, while a front and internal mesh pocket give you easy access to your sunglasses, keys or smartphone. The AMPC Pack is the smarter way to pack. Imported.

- + Stowable Hypalon backpack straps
- + Integrated Hypalon tab for zipper stop or compression
- + Hydration bladder strap and full loop back panel
- + 500D nylon



Attaches to All Missions and TacTec Plate Carriers (not included).

56493 AMPC Pack | 16-liter (976 cu. in.) | Black 019, Kangaroo 134, Ranger Green 186 |

BLACK 019

KANGAROO 134

RANGER GRN 186



AMP10™

20L

Small but mighty, the AMP10™ backpack is built to be tough, flexible and comfortable. It offers virtually limitless options for mounting or attaching gear with 5.11's innovative HEXGRID® multi-angle load-bearing system and Gear Set™ compatibility. This super pack includes a dual-entry front compartment, full-loop platform and webbing loops for internal Gear Set™ placement within the main compartment. It forms to your body for total support via the thermoformed ergonomic back panel. Removable shoulder straps can be converted from backpack to sling with crossbody strap. Imported.

- + Bag converts from backpack to slingpack
- + CCW pocket
- + 500D nylon dobby (body), 1050D nylon (bottom)

56431 AMP10 | 20-liter (1220 cu. in.) | Tungsten 014, Black 019, Kangaroo 134, Ranger Green 186 |



TUNGSTEN 014

BLACK 019

KANGAROO 134

RANGER GRN 186



AMP12™

25L

Set your course and move out. The AMP12™ backpack is engineered for durability, flexibility and comfort. Compact and efficient, it features 5.11's innovative HEXGRID® load-bearing system, which offers unprecedented options for mounting or attaching gear. The AMP12™ has two compartments, including a full-loop platform and webbing loops for internal Gear Set™ placement. The thermoformed ergonomic back panel forms to your body for total support, and the CCW pocket adds total peace of mind. Imported.

- + Hydration/laptop compartment
- + CCW pocket
- + 500D nylon doobby (body), 1050D nylon (bottom)



56392 AMP12™ | 25-liter (1525 cu. in.) | Tungsten 014, Black 019, Kangaroo 134, Ranger Green 186 |

TUNGSTEN 014

BLACK 019

KANGAROO 134

RANGER GRN 186



AMP24™

32L

Perfect for an overnight mission or an all-day trek, the AMP24™ backpack is made to load up, but light enough to just go. Equipped with 5.11's innovative HEXGRID® load bearing system, it offers all-new options for mounting or attaching gear. The AMP24™ has two compartments, including a full-loop platform and webbing loops for internal Gear Set™ placement. The thermoformed ergonomic back panel helps keep you ultimately comfortable, while the CCW pocket adds precious peace of mind. Imported.

- + Hydration/laptop compartment
- + CCW pocket
- + 500D nylon dobby (body), 1050D nylon (bottom)

56393 AMP24™ | 32-liter (1950 cu. in.) | Tungsten 014, Black 019, Kangaroo 134, Ranger Green 186 |

56393G7 GE07 AMP24™ | 32-liter (1950 cu. in.) | GE07 Night 357, GE07 Terrain 865 |



TUNGSTEN 014

BLACK 019

KANGAROO 134

RANGER GRN 186

GE07 NIGHT 357

GE07 TERRAIN 865



AMP72™

40L

So your overnight assignment just got extended by a few days. No problem. The roomy AMP72™ backpack is Gear Set™ compatible and ready when you are. With 5.11's innovative HEXGRID® load bearing system, it gives you brand-new options for mounting or attaching gear. This beast also features a side-opening compartment that holds up to a 24" rifle with the MOLLE-based platform, muzzle sleeve and a removable retention strap. The thermoformed ergonomic back panel keeps you comfortable and an aluminum back panel frame protects your back against heavy lifts. Imported.

- + Hydration/laptop compartment
- + Padded waist belt with pockets for quick grab items
- + CCW pocket
- + 500D nylon dobby (body), 1050D nylon (bottom)

56394 AMP72™ | 40-liter (2440 cu. in.) | Tungsten 014, Black 019, Kangaroo 134, Ranger Green 186 |



TUNGSTEN 014

BLACK 019

KANGAROO 134

RANGER GRN 186

AMP PACK SIZE COMPARISON

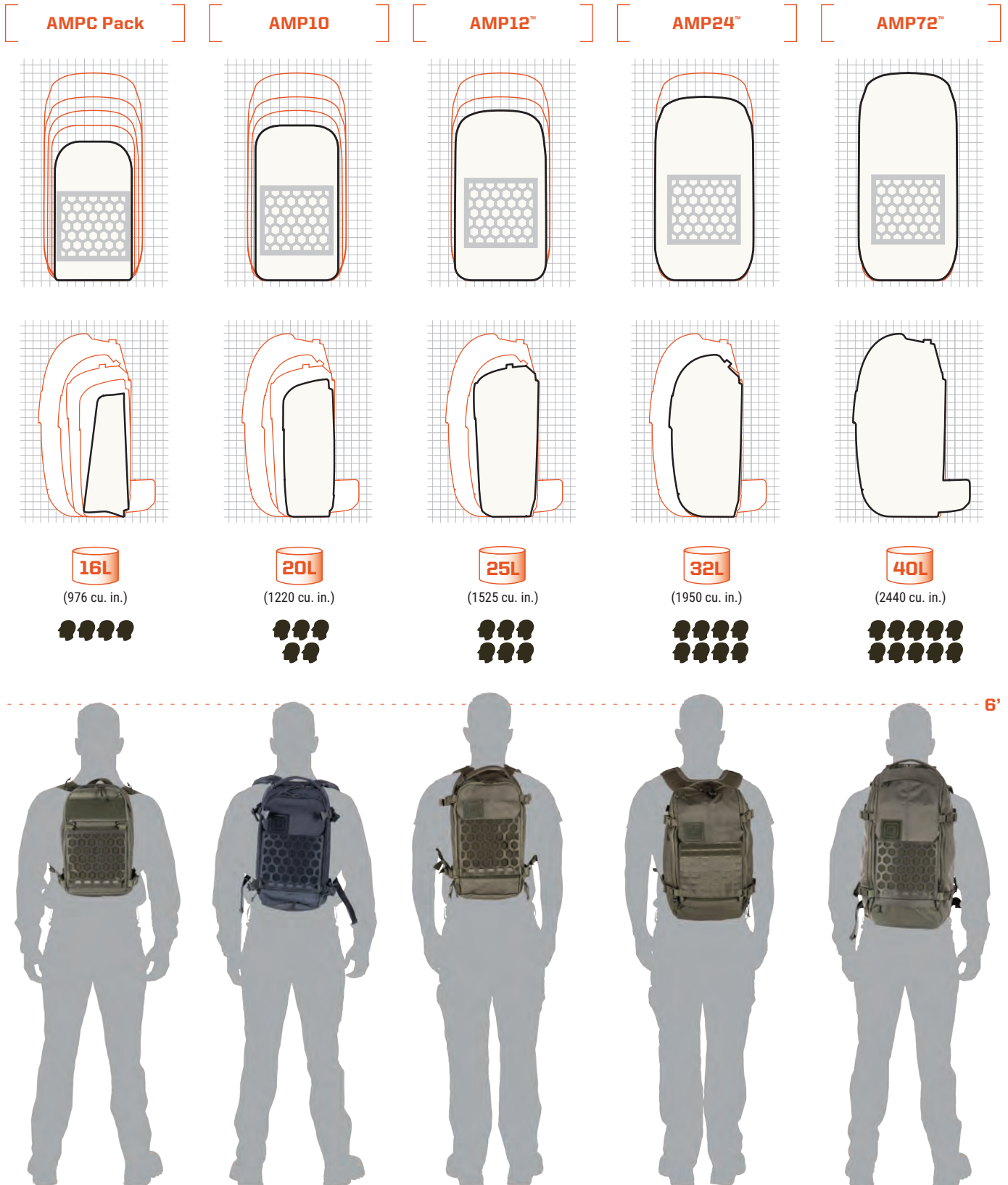

6'



An adult human head is approximately four liters of volume.



Icon Pant, p. 22
Cable Hiker, p. 181



RUSH12™



On a long day hike or for everyday use, as a tactical assault pack, hunting backpack or an emergency go-bag, the RUSH12 keeps you organized and on mission. Sixteen total compartments, each sized for a specific use, give you virtually endless storage options. There's an internal admin panel for small accessories, a hydration pocket to keep you going and a fleece-lined sunglasses pocket to protect your eyewear. Last but not least, the wrap-around web platform is MOLLE and 5.11 SlickStick® System-compatible. Imported.

- + Main compartment = 18" x 11" x 6-1/2"
- + Capacity = 1476 cu in, 24 liters

56892 RUSH12™ | Black 019, Double Tap 026, Tac OD 188, Sandstone 328 |

56954 RUSH12™ | MultiCam® 169 |

BLACK 019

DOUBLE TAP 026

MULTICAM 169

TAC OD 188

SANDSTONE 328





RUSH24™



When it comes to efficiency, this is the tactical backpack of choice. Our most popular pack, the RUSH24 is ideal for overnight treks or heavier everyday use. It has more than 20 compartments to stow your stuff, including a roomy main compartment with three mesh pockets, a padded hydration pocket and a fleece-lined sunglasses pocket. A large stuff-it pocket lets you add gear as needed. The wrap-around web platform is MOLLE/5.11 SlickStick® System-compatible for even more storage options. But even fully loaded, RUSH24's contoured shoulder straps and adjustable sternum straps keep you comfortable. Imported.

- + Main compartment = 20" x 12-1/2" x 8"
- + Capacity = 2275 cu in, 37 liters

58601 RUSH24™ | Black 019, Double Tap 026, Flat Dark Earth 131, Tac OD 188, Sandstone 328, Dark Navy 724 |

56955 RUSH24™ | MultiCam® 169 |

BLACK 019

DOUBLE TAP 026

STORM 092

FLAT DARK
EARTH 131

MULTICAM 169

TAC OD 188

SANDSTONE 328

DARK NAVY 724





RUSH72™



If you're up for a three-day jaunt into the mountains or slated for a weekend of tactical duty, the RUSH72 is your best friend. Perfectly sized and structured for hauling more gear in not-so-friendly environments, it's built with highly resilient, water repellent nylon, and did we mention the aluminum spine? This pack raises your org game, too. The MOLLE / TacTec® System-compatible web platform keeps your gear within reach. There's an admin pocket to store maps, pens and documents, a shove-it compartment, integrated org pockets and a hydration compartment with hangers and toggles. Ready, set, go. Imported.

- + Main compartment = 23" x 13-1/2" x 8-1/2"
- + Capacity = 3342 cu in, 55 liters

58602 RUSH72™ | Black 019, Double Tap 026, Storm 092, Flat Dark Earth 131, Tac OD 188, Sandstone 328 |

56956 RUSH72™ | MultiCam® 169 |

BLACK 019

DOUBLE TAP 026

STORM 092

FLAT DARK
EARTH 131

MULTICAM 169

TAC OD 188

SANDSTONE 328





ALL-HAZARDS NITRO

21L

Take the fight with you. The All Hazards Nitro Bag features dual main compartments, a 180° opening for easy access, pass-through slots for breaching tools or a baton, loop patches and a three-surface MOLLE- and SlickStick®-compatible web platform. An orange lining helps you identify your gear in low-light, and the all-purpose shove-it pocket holds your helmet or jacket. The All-Hazards Nitro also features a fleece-lined sunglasses pocket, side-mounted retention lanyards and a quick-grip top handle. Bag of the brave. Imported.

56167 All Hazards Nitro | Black 019, Double Tap 026, Sandstone 328 |

BLACK 019

DOUBLE TAP 026

SANDSTONE 328



ALL-HAZARDS PRIME

29L

The All Hazards Prime is meaner than your average bag. Designed with input from MACTAC instructors, the bag's main compartment can hold two Ammo Mules or other equipment, while the front panel unzips 180° for full access to a MOLLE- and SlickStick-compatible medical compartment. The bag features an internal laptop sleeve, dedicated hydration or armor compartment and an all-purpose shove-it pocket for quick storage of a helmet or jacket. We finish it up with a fleece-lined sunglasses pocket, side-mounted retention lanyards, and a quick-grip top handle so there's no excuse for not being ready. Imported.

56997 All Hazards Prime | Black 019, Double Tap 026, Tac OD 188, Sandstone 328 |

BLACK 019

DOUBLE TAP 026

TAC OD 188

SANDSTONE 328





RUSH LBD DUFFELS

Built to haul heavy loads like armor and equipment, our RUSH LBD (Load Bearing Duffels) are available in three sizes and made from durable 1050D nylon, with webbing and heavy-duty bartacking reinforcements throughout. Featuring interior mesh pockets, lashing straps, compression straps and grab handles, the duffels can be shouldered or worn as a backpack. RUSH LBD Duffels are MOLLE-compatible, giving you customizable storage options. Topped off with nametape holders and rainfly enclosures, these bags mean business. Big business. Imported.

56293 RUSH LBD Mike | Black 019, Kangaroo 134, Tac OD 188, Sandstone 328 | 11" H x 20" L x 10" W; 2440 cu in |

56294 RUSH LBD Lima | Black 019, Tac OD 188, Sandstone 328 | 12" H x 24" L x 12" W; 3456 cu in |

56295 RUSH LBD Xray | Black 019, Tac OD 188, Sandstone 328 | 15" H x 31" L x 14" W; 6510 Cu. In. |

BLACK 019

KANGAROO 134

TAC OD 188

SANDSTONE 328

RED 8100 DUFFEL

134L

Keep it simple with our 8100 Duffel, a durable, high-performance carryall built from rugged 1050D nylon. The main compartment features a light-colored interior for visibility, and the inside hanging pocket is perfect for your accessories. Oversized zipper pulls provide easy access while wearing gloves, and a water-resistant coating keeps your gear dry. Imported.

56878 RED 8100 Bag | Fire Red 474 | 32" x 16" x 16"; 8192 cu. in. (134 liters) |



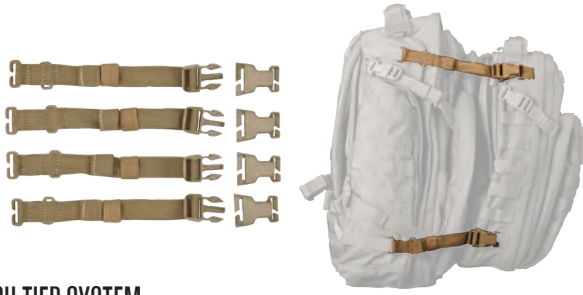

RUSH TIER SYSTEM

The RUSH Tier System is a versatile four-piece strap system that connects 5.11® RUSH MOAB™ packs to other bags with web platforms. Imported.

| **56957 RUSH Tier System** | Black 019, Sandstone 328 |



RUSH TIER SCABBARD

Attach the RUSH Tier Scabbard to the front or side of any 5.11 RUSH pack to securely, easily transport your long gun. The padded wrap covers trigger and optics and the adjustable Scabbard includes the RUSH Tier System. Imported.

| **56086 RUSH TIER Scabbard** | Sandstone 328 |



WRITEBAR™ NAME TAPES

Mark your gear's ID or contents with a marker or paint pen on a WriteBar™ name tape. Engineered with strong hook backing and 1050D nylon, you can ensure all your stuff has a name. Imported.

| **81438 WriteBar™ Name Tape 3x1** | Black 019, Kangaroo 134, Ranger Green 186, Fire Red 474 |

| **81437 WriteBar™ Name Tape 6x1** | Black 019, Kangaroo 134, Ranger Green 186, Fire Red 474 |



SIDEWINDER STRAPS

Secure additional items to your favorite tactical gear and take maximum advantage of your web platforms with Sidewinder Straps. Sidewinder Straps are a rigid nylon insert with a auto-cinching integrated CAM lock that locks into web/MOLLE platforms. Quickly attach a jacket, poncho, tarp or other cover to any web/MOLLE platform.

- + Nylon body locks onto webbing
- + Adjustable and cinchable nylon webbing
- + Small occupies 1 column & 1 row of MOLLE, 1.25" W x 2.5" H
- + Large occupies 1 column & 3 rows of MOLLE, 1.25" W x 6.5" H

| **56482 Sidewinder Straps - SM** | 2 Pack | Black 019, Kangaroo 134, Ranger Green 186 |

| **56485 Sidewinder Straps - LG** | 2 Pack | Black 019, Kangaroo 134, Ranger Green 186 |



BAILOUT BAG

9L

An always-ready solution for urgent operations, the Bailout Bag has outside pockets made to house six standard AR magazines or three .308 magazines, plus additional internal and external platforms that are MOLLE-, SlickStick-, and TacTec®-compatible. Built from rugged, lightweight, all-weather 1050D nylon, featuring an adjustable quick-release strap, the Bailout Bag will see you through the day's battle. Imported.

| **56026 Bailout Bag** | Black 019, Flat Dark Earth 131 |

BLACK 019

SANDSTONE 328



PUSH™ PACK

6L

The PUSH Pack is popular among frequent travelers who require a reliable carryall with tactical utility. The bag features a main compartment, expandable side compartments, a TacTec-compatible pocket at the rear, and MOLLE- and SlickStick-compatible slots on the sides. With a hook-and-loop nametape and flag holders for quick ID, the PUSH Pack meets all your grab-and-go needs. Imported.

| **56037 PUSH Pack** | Black 019, Flat Dark Earth 131 |

BLACK 019

SANDSTONE 328



2-BANGER BAG

3L

Engineered from rugged 500D nylon, the 2-Banger Bag carries two AR magazines using traditional flap and bungee-retention storage options. A loop-sided TacTec® compartment secures your backup pistol, while dual zippered front pockets hold additional EDC items. Imported.

| **56180 2 Banger** | Black 019, Double Tap 026, OD Trail 236, Sandstone 328 | 8" H x 9.5" L x 3" W; 200 Cu. In. |

BLACK 019

DOUBLE TAP 026

OD TRAIL 236

SANDSTONE 328



4-BANGER BAG

5L

Built from rugged 500D nylon, the low-vis 4-Banger Bag carries four AR magazines using traditional flap and bungee-retention storage options. A loop-sided TacTec® compartment secures your backup pistol, while dual zippered front pockets hold extra EDC items. The ambidextrous strap design provides comfort for all-day carry. Imported.

| **56181 4 Banger** | Black 019, Double Tap 026 | 8" H x 15.5" L x 3" W; 325.50 Cu. In. |

BLACK 019

DOUBLE TAP 026



MOAB™ 6



The ambidextrous MOAB™ 6 sling pack thrives in harsh environments. This everyday tactical pack features an interior pocket for your tablet and accessories, an admin panel for those EDC must-haves and a coms pocket to keep you connected. Secure your CCW inside the hidden rear compartment and stash your shades in the fleece-lined sunglasses holder. No matter how hot it gets, you'll be ready thanks to the integrated 1.5-ltr. hydration bladder. Need to carry more stuff? No sweat. The MOAB 6 integrates with other RUSH backpacks via the RUSH Tier. Imported.

56963 MOAB 6 | 11L capacity, 10.5" H x 9" W x 7" D | Black 019, Double Tap 026, Storm 092, Tac OD 188, Sandstone 328 |

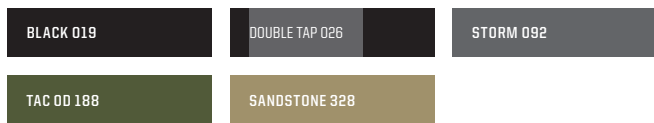

MOAB™ 10



For those longer missions in unforgiving environments, choose the MOAB™ 10 sling pack. This ambidextrous pack contains a primary compartment for your tablet and accessories, an admin panel for EDC items and a coms pocket to keep you connected. Stow your sidearm inside the hidden rear compartment and protect your sunglasses in the fleece-lined holder. No matter how hot the action gets, you'll be ready thanks to the integrated 1.5-ltr. hydration bladder. The MOAB 10 can be attached to other RUSH backpacks via the RUSH Tier System. Imported.

56964 MOAB 10 | 18L capacity, 18.25" H x 9" W x 7.25" D | Black 019, Double Tap 026, Storm 092, Tac OD 188, Sandstone 328 |

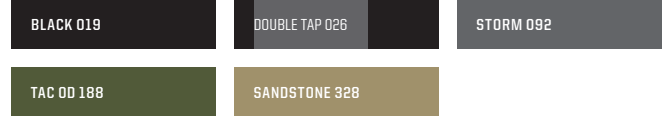



RUSH DELIVERY MESSENGERS



Most messengers simply can't handle the Always Ready lifestyle, which is why we created the RUSH Delivery Messenger Bag. Constructed from rugged, water-resistant 1050D nylon, the RUSH Delivery secures your documents and essentials in the main compartment, while protecting your laptop in a padded sleeve. The quick-access admin panel keeps your EDC must-haves at your fingertips, while a rapid-draw compartment offers fast access to your CCW. An exterior wrap-around platform that's compatible with MOLLE, SlickStick® and TacTec® systems provides additional carry capabilities. Long-distance hauling is a breeze thanks to the wide cross-body strap. This is one tough mother of a messenger bag. Imported.

56176 RUSH Delivery MIKE | Black 019, Double Tap 026, OD Trail 236, Sandstone 328 | 11" H x 14" L x 2.5"; 385 Cu. In. (6 liters) |

56177 RUSH Delivery LIMA | Black 019, Double Tap 026, OD Trail 236, Sandstone 328 | 11" H x 17" L x 4" W; 748 Cu. In. (12 liters) |

BLACK 019

DOUBLE TAP 026

OD TRAIL 236

SANDSTONE 328



Concealment compartment.



Padded laptop compartment.



COVRT18™ BACKPACK

30L

Designed to appear subtle and inconspicuous, the COVRT18 is a full-sized pack that delivers superior utility in a low-vis setup. The rugged 500D and 420D water-resistant nylon construction is made to last. Ideal for CCW use, the backpack features a TacTec® system-compatible hidden pistol pocket, a Roll-Down Assault Compartment (R.A.C.™) for MOLLE or web pouches and a quick-access flex cuff channel. The main compartment includes a built-in padded laptop sleeve along with roomy primary and secondary storage zones. Stash your sunglasses in the fleece-lined pocket and your ID in the flip-down panel. The QuickTact shoulder straps, adjustable yoke shoulders and compression straps keep everything in place. Imported.

56961 COVRT18 Backpack | Black 019, Asphalt/Black 021, Ice/Smoke Grey 049, Foliage/Sandstone 180 |

BLACK 019

ASPHALT/BLK 021

ICE/SMK 049

FOL/SSTONE 180

RAPID EXCURSION PACK

23L

The Rapid Excursion Pack is big enough for your gym essentials, a simple overnighter or an afternoon hike. One-handed cinch closure, aerospace mesh shoulder straps. Imported.

56182 Rapid Excursion Pack | Double Tap Black 026, Sandstone 328 |





SELECT CARRY PACK™

15L

The low-profile Select Carry Pack™ is built for operations that require stealth. This pack is sized for a submachine gun with a length of 600 mm or less, or can be loaded up with a full first responder kit. Made with 1050D and 840D nylon, the Select Carry Pack features internal web platforms and a TacTec® system-compatible panel in the front pocket. A removable Select Carry Pistol Pouch deceptively fits a full-sized pistol and magazines. The Select Carry Pistol Pouch is also available separately. Imported.

58603 Select Carry Pack | Charcoal/Black 018, Black 019 |

58604 Select Carry Pistol Pouch | Charcoal/Black 018 |



Color-blocking breaks up the perceived size of the Pistol Pouch, fits a full-sized pistol.



MORALE PACK

20L

Nothing lifts your spirits like having the right gear at the right time. Not only is the Morale Pack a lightweight 20L day pack with 5.11's CenterLine™ design, it's up for carrying all you need for a full day of venturing out. The Morale features a large loop panel on the front of the pack, a dedicated 15" laptop pocket and shoulder straps for your favorite patches or hook-and-loop attachments as well as a web/MOLLE platform on the left side and a water bottle pocket on the right side. And of course, you have to know where everything is. That's why we included a front admin pocket to help organize your EDC essentials. Imported.

56447 Morale Pack | 18.5"H x 11.0W x 6.0"D, 20L capacity | Black 019, Double Tap 026, Kangaroo 134 |

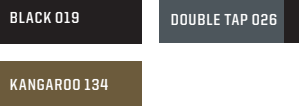



LV18

30L

The LV18 offers tactical versatility and everyday ease in a low-vis 30L profile. The main compartment holds a 15" laptop in its padded sleeve, a designated compartment secures your CCW and a channel holds your flex cuffs. A third compartment features slip and zippered pockets. And for the control freak in you, the front compartment has a laser-cut loop panel and a layered pocket approach to organization. Imported.

- + Lower webbings straps for attaching the LV6 or other cargo
- + Expandable side pockets with snap closure and compression strap
- + CCW compartment and flex cuff channel
- + 840D Nylon

56436 LV18 | 19.75"H x 11"W x 5.5"D, 30L capacity (1831 cu. in.) | Black 019, Tarmac 053, Night Watch 734 |



BLACK 019

TARMAC 053

NIGHT WATCH 734



LV10

13L

Everyday carry is anything but boring with the LV10 sling pack. Its over-the-shoulder design makes it easy to have your gear within reach without being in your way. Outside, the exterior is low-vis. Inside, the LV10 is blatantly loaded with organization, with a concealment compartment, a tablet pocket, admin panel and zippered pockets. Imported.

- + CCW compartment with hot pulls, separate flex cuff channel
- + Fleece lined eyewear/media pocket
- + 840D Nylon



56437 LV10 | 10.5"H x 16.25"W x 5.7"D, 13L capacity (793 cu. in.) | Black 019, Tarmac 053, Night Watch 734 |

BLACK 019

TARMAC 053

NIGHT WATCH 734



LV10 opens to reveal robust internal organization and great interior visibility.

LV6

3L

From crossbody bag to waist pack, the LV6 is packed with utility and flexibility and can also be attached to the LV18 backpack. The LV6 can be worn in four ways to help enable easy CCW and EDC carry. 840D nylon. Imported.

56445 LV6 | 3L capacity (183 cu. in.) | Black 019, Tarmac 053, Night Watch 734 |

BLACK 019

TARMAC 053

NIGHT WATCH 734



LV6 can be worn as a fanny pack, crossbody, rear slingpack or as a shoulder bag.





DART PACK

25L

Designed for maximum storage efficiency and tactical readiness, the Dart Pack features an angled zip main compartment, a removable panel with laptop sleeve and MOLLE attachment panel for pouches that can be placed in either the main or rear compartments. Built with nylon oxford, this is one durable pack for a long trek or a weekend mission. The slick faced exterior blends into a crowd so you can confidently carry using the TacTec™ CCW compartment, which is also hydration compatible. Imported.

- + Padded laptop compartment
- + 420D Nylon
- + 5.11's signature CenterLine™ design

56442 Dart Pack | Heather Grey 294 |

HEATHER GREY
294



Padded internal 15" laptop compartment



DART24 PACK

30L

A low-vis appearance cleverly conceals the DART24 pack's bold interior functionality – in an excellent EDC and CCW platform. The front features our 5.11® Signature CenterLine™ design, and side entry compartments contain dedicated admin and organization panels. The laptop compartment is removable, allowing for even more customizable storage options. A padded back with air-spacer mesh delivers comfortable carry of this pack's 30L capacity. Try a DART24 on for size. Bet it's the perfect fit. Imported.

- + Removable laptop compartment
- + 420D Nylon (56439) / 300D Nylon (56441)
- + 5.11's signature CenterLine™ design

56439 DART24 Pack | Black 019, Night Watch 734, Grenade 828 | 30L

BLACK 019

NIGHT WATCH
734

GRENADA 828



Removable/convertible 15" laptop insert



DART DUFFEL

40L

A true professional and the quintessential chameleon, the Dart Duffel cuts a refined low-vis exterior that's capable of traveling in the most covert circles. The interior, on the other hand, is shamelessly loaded with functionality and organization. For instance, the interior web/MOLLE panel, dual-entry zippered mesh pockets and loop strips allow you to mix up your gear as you like. Add a concealed loop-sided TacTec® CCW compartment on the back of the bag, and you've got an insane range of storage options. The Dart Duffel also offers a 40L capacity and a removable storage cube. What else could you possibly need? Imported.

- + Removable storage cube (9" x 11" x 5.25")
- + 420D Nylon (56440) / 300D Nylon (56443)
- + 5.11 Signature CenterLine™ design

56440 Dart Duffel | Black 019, Night Watch 734, Grenade 828 | 40L |

BLACK 019

NIGHT WATCH
734

GRENADE 828



Includes removable packing cube.





RAPID QUAD-ZIP PACK

28L

If your daily gear bag needs a re-org, the Rapid Quad Zip Pack is how you chart it. The Rapid Quad features the ultimate in all-access storage: A 270° U Zip main compartment with access at all four corners. The body is constructed with durable 600D polyester and features handy pockets, interior mesh pockets and a waterbottle pocket plus side compression straps. Don't forget your laptop – just stow it safely in the padded compartment and be on your way. Imported.

| 56371 Rapid Quad-Zip Pack | Khaki 055, True Black 264 |



RAPID ORIGIN PACK

25L

Inspired by our battle-tested backpacks, the Rapid Origin Pack is a lightweight, medium-sized solution for a dayhike, or whatever you feel like taking on. Built with a large drop-front inverted U opening, the interior is easy to access and, if you can't avoid bringing that laptop, there's a padded compartment to keep it safe and secure. Made from color-contrast 600D polyester, the Rapid Origin features multiple quick-release and adjustable straps to customize the fit. There's a large web platform on the front to add pouches or gear, a secure CCW compartment and an internal admin panel. Imported.

| 56355 Rapid Origin Pack | Black 019, Kangaroo 134, Ranger Green 186, True Black 264 |



25L

MIRA 2-IN-1 BACKPACK

Function and form come together in a colorful way with the Mira 2-in-1 Backpack. The pack is built for versatility and features a front storage pouch that can be removed and used as a crossbody bag. The main compartment features a dedicated 15" laptop compartment, zippered sunglass pocket and external mesh water bottle pockets. The front pouch features a TacTec™ system compatible CCW compartment with a magnetic closure. Imported.

- + Padded laptop compartment
- + 420D Nylon
- + Removable crossbody bag can be worn independently

56338 Mira 2-in-1 Backpack | Stone 070, Stealth Black 266, Fig 560, Peacoat 787 |



MIRA CROSSBODY BAG

Take easy, secure everyday carry along for the ride. The Mira Crossbody sports multiple pockets, including interior org panel pockets for your phone, pens, mags and more. The MOLLE compatible front panel makes changing your set up easy. There's also a rear pocket with magnetic closure as well as an adjustable shoulder strap. Imported.

56467 Mira Crossbody Bag | Black 019, Tac OD 188 |





CAMS™ 3.0



Picture the CAMS™ (Carry All My Stuff) 2.0, yet stronger, tougher and more versatile. The 5.11 CAMS 3.0 lives up to the reputation of the ultimate large deployment bag or travel companion. This beast has a PE support board and withstands high impacts in extreme environments. With multiple, secure compartments and pockets, you can safely transport everything from documents to your armor to your rifle – all kept in place with skid rails for support and load displacement, and removable fiberglass rods in the molded side panels. Pack up and roll out. The CAMS 3.0 can handle it. Imported.

+ 1050D nylon / 1680D nylon / 8.9kgs

56475 CAMS 3.0 | 186.5L | Black 019, Double Tap 026, Kangaroo 134, Ranger Green 186 |

- BLACK 019
- DOUBLE TAP 026
- KANGAROO 134
- RANGER GREEN 186

-  LOAD READY
-  LOCKABLE ZIPPERS
-  REINFORCED ZONES



Corner guards and U Foot lashing points.



Upgraded wheels and wheel housings are user replaceable.



Corner protectors are user replaceable.



Lockable YKK® zippers.

Replacement Parts: 90151 3.0 Luggage Wheels, 90152 3.0 Wheel Housings, 90153 CAMS 3.0 Skid Rail, 90156 Corner Protectors, 90157 U Foot lashing point.



SOMS™ 3.0



The SOMS™ (Some of My Stuff) 2.0 just got tougher and more versatile. Our 5.11's SOMS 3.0 rolling duffel bag gives you even more customizable storage and travel-friendly features to keep you organized, no matter your destination. It withstands high impacts in extreme environments that 5.11 customers are known to frequent. With a roomy main compartment and pockets, you can safely transport everything from documents (flat) to your uniforms and gear – all kept in place with skid rails for support and load displacement, removable fiberglass rods, and molded side panels. Pack up the SOMS 3.0 and roll out. Imported.

+ 1050D nylon / 1680D nylon / 7.4kgs

56476 SOMS 3.0 | 126L | Black 019, Double Tap 026, Kangaroo 134, Ranger Green 186 |

BLACK 019

DOUBLE TAP 026

KANGAROO 134

RANGER GREEN 186



LOAD READY



LOCKABLE ZIPPERS



REINFORCED ZONES



Corner guards and U Foot lashing points.



Upgraded wheels and wheel housings are user replaceable.



Corner protectors and bottom skid rails are user replaceable.



Haul handle retracts into bag.

Replacement Parts: 90151 3.0 Luggage Wheels, 90152 3.0 Wheel Housings, 90154 SOMS 3.0 Skid Rail, 90156 Corner Protectors, 90157 U Foot lashing point.



MISSION READY™ 3.0



Outstanding durability, flexibility and value make the Mission Ready 3.0 rolling duffel a must have. Upper and lower compartments, side pockets and a flat document pocket give you more ways to get, and stay organized. Moisture and weather-resistant, the Mission Ready 3.0 is built to keep your essentials ultimately secure. We added skid rails for support and load displacement and fiberglass rod in the side panels. For your next mission, this bag is ready. Imported.

+ 1050D nylon / 1680D nylon / 4.4kgs

56477 Mission Ready 3.0 | 90L | Black 019, Double Tap 026, Kangaroo 134, Ranger Green 186 |

BLACK 019

DOUBLE TAP 026

KANGAROO 134

RANGER GREEN 186



U Foot lashing points are user replaceable.



Upgraded wheels and wheel housings are user replaceable.



Corner protectors and bottom skid rails are user replaceable.



Haul handle retracts into bag.

Replacement Parts: 90151 3.0 Luggage Wheels, 90152 3.0 Wheel Housings, Mission Ready 3.0 Skid Rail, 90156 Corner Protectors, 90157 U Foot lashing point.



LOAD UP 22" CARRY ON

45L

Traveling with your EDC gear doesn't have to be complicated. At least not with our Load Up 22" Carry On. Constructed for simplicity, safety and convenience, the Load Up features a hard shell PC main compartment with expandable zipper (adds 2" depth). Your laptop travels in the padded laptop sleeve in the compression molded EVA lid compartment, which also features an admin pocket and access to the middle compartment. The name tape and ID sleeve make securing and accessing your ID or other vital documents worry-free. Imported.

- + P1680D (lid), N1050D (center), polycarbonate (bottom)
- + 22" x 14" x 9" (11" expanded)

56435 Load Up 22" Carry On | 45L (55L expanded) | Volcanic 098, Ranger Green 186 |

VOLCANIC 098
RANGER GREEN 186

Replacement Parts: 90158 Load Up Wheels



NEW

CONVOY PACKING CUBES

Whether you're aiming for a weekend away, a long-term trip, or organizing all of the gear in your vehicle, the Convoy Packing Cubes are ready to keep your kit in order. Each cube features a mesh face for visibility and a grab handle. Sierra and Mike sizes are expandable by 2" and the Lima size expands by 3" for flexibility.

- + N219 mini ripstop (N66) PU coated body
- + Open main compartment for storage
- + Full mesh back wall for visibility
- + Grab handle

56600 Convoy Packing Cube Sierra | 5.25" x 7" x 2" | .2/.3L (101/174 cu. in.) | Black 019, Kangaroo 134 |

56601 Convoy Packing Cube Mike | 7" x 10.5" x 2" | .3/.6-liter (202/349 cu. in.) | Black 019, Kangaroo 134 |

56602 Convoy Packing Cube Lima | 10.5" x 13.875" x 3" | .6/1.4-liter (400/837 cu. in.) | Black 019, Kangaroo 134 |



BLACK 019

KANGAROO 134

**NEW****CONVOY STUFF SACKS**

Clean base layers, dirty laundry or the week's supply of snacks, stash it all in the Convoy Stuff Sack. Available in two sizes, the stuff sacks feature a 'bucket' style opening with a drawcord closure.

- + N219 mini ripstop (N66) PU coated body
- + Large main compartment for all purpose quick storage
- + Drawstring closure with cord lock and webbing pull tab

56603 Convoy Stuff Sack Mike | 17 in. long x 9 in. wide x 6 in. deep
| 1.5-liter (891 cu. in.) | Black 019, Kangaroo 134 |

56604 Convoy Stuff Sack Lima | 21 in. long x 10 in. wide x 6 in. deep |
| 2.1-liter (1260 cu. in.) | Black 019, Kangaroo 134 |

BLACK 019

KANGAROO 134

**NEW****CONVOY DOPP KIT**

Keep your toiletries or other gear ready with the Convoy Dopp Kit. Internal mesh divider and a zippered mesh pocket helps with organization.

- + N219 mini ripstop (N66) PU coated body
- + Large main compartment with internal organization
- + Grab handle and YKK® zipper closure

56605 Convoy Dopp Kit | .6-liter (234 cu. in.) | Black 019, Kangaroo |

BLACK 019

KANGAROO 134

**JOEY POUCHES**

For all your EDC must-haves, the Joey is constructed with durable, water-resistant Hypalon®, with the added reliability of a YKK® AquaGuard® zipper. Carry on. 7" x 10" or 9" x 12" sizes. Imported.

56454 7.10 Joey Pouch | Black 019, Kangaroo 134, Ranger Green 186
| 7x10 |

56455 9.12 Joey Pouch | Black 019, Kangaroo 134, Ranger Green 186
| 9x12 |



NEW
BASIC PATROL BAG

37L

Built using rugged, all-weather 600D polyester, the Basic Patrol Bag is a readiness-optimized storage solution for trunk, cab or even passenger seat. The spacious primary compartment intended for the bulk of your items can be arranged to personal spec with removable dividers and other organization measures like zippered and slip pockets on the lid, a hook and loop closure front pocket. Baton loops will secure smaller, more sensitive or more frequently accessed implements. There's also a loop ID panel and business card ID holder for a proclamation of ownership – gear left adrift is a gift! Imported.

| **56523 Basic Patrol Bag** | Black 019 |



PATROL READY™ BAG

40L

Our Patrol Ready™ Bag keeps your duty gear organized and quickly accessible. Built from rugged, all-weather 600D polyester, the Patrol Ready Bag features multiple exterior pockets to store your flashlight, baton, radio, water bottles and more. The large interior compartment includes an adjustable separator, two zippered pockets and additional admin pockets. Sturdy grab handles and a removable shoulder strap make transporting easy, while the transparent ID panel marks your stuff. Imported.

59012 Patrol Ready Bag | Black 019 |





WINGMAN PATROL BAG™

39L

We designed the Wingman Patrol Bag™ to ride in the front passenger seat, secured with a seat belt pass-through and the upper panel fastened to the headrest. The Wingman serves as a tactical organizer, toolkit and gear bag. Easily reach your patrol essentials thanks to the dual-fold-open web platforms and foldout organizer panel. Adjustable inner dividers, zippered and mesh pockets offer nearly limitless storage options. An exterior MOLLE platform provides additional storage. When your shift is over, the Wingman transitions to a traditional patrol bag. Imported.

| 56045 Wingman Patrol Bag | Black 019 |



SIDE TRIP™ BRIEFCASE

32L

Our popular, multi-functional Side Trip Briefcase is built for the battlefield and the boardroom. Crafted from rugged, stylish 1050D texture nylon, with molded handles and a removable shoulder strap, the bag offers a useful, professional profile. The interior feature MOLLE and 5.11SlickStick® compatible storage options, a roomy main compartment made to hold a 16" laptop, and a TacTec® compatible covert pocked sized for a sidearm. Side pocket blouse out to hold bulky items, and a rain cover stows in the bottom of the bag. Imported.

| 56003 Side Trip™ Briefcase | Black 019 |







OPERATOR ALS BACKPACK

26L

For what you do, you need gear you don't have to think about, let alone second guess. Meet the Operator ALS Backpack, with four removable, color-coded Easy-Vis Med Pouches and two long internal pockets to keep vital supplies within reach. A dedicated, padded compartment can be used for hydration, stowing your tablet or carrying a litter. The main compartment is primed for internal Gear Set™ placement. The ALS pack is smart and tough on the outside, too. Its nylon 1050D body and waterproof poly 1000D base construction stands up to punishment shift after shift, and reflective pulls and piping help you stay visible. 20" H x 11.5" W x 8.75" D / 1586 cu. in. / 26L capacity. Imported.

- + Double Deploy Gear Set™ included
- + Dedicated, padded hydration, tablet or litter carry compartment
- + High abrasion resistant 1050D nylon and waterproof 1000D poly

| 56395 Operator ALS Backpack | 26L capacity | Black 019 |



The Operator ALS Backpack includes a Double Deploy Gear Set™ with two individually removable stretch pockets to keep essential gear at hand and easily shared.



56406 Easy-Vis Med Pouch | 7" x 6.5" x 3.5" | Black 019, Yellow 372, Cherry Bomb 476, Royal Blue 693, Shamrock Green 839



NEW

TAC OPERATOR ALS BACKPACK

26L

The Tac Operator ALS is the Operator ALS Pack's tactical cousin with all 1050D nylon material and no reflectivity. With the included Double Deploy Gear Set™, four color-coded Easy-Vis Med Pouches, and additional real estate configured for both internal and external Gear Set™ mounting, the Tac Operator has plenty of room for both necessities and niceties... though hopefully you have a priority on the former. How you configure your pack is up to you, and dependent on mission and need. Your ability to configure effectively is up to the pack. The Tac Operator ALS more than meets that responsibility.

- + Double Deploy Gear Set™ included
- + Dedicated, padded hydration, tablet or litter carry compartment
- + High abrasion resistant 1050D nylon

| 56522 Tac Operator ALS Backpack | 26L capacity | Kangaroo 134 |





EASY-VIS MED POUCH

Additional Med Pouch for the Operator ALS Backpack or AMP Backpack. The top and front panels are made of clear vinyl, so you can see exactly what you're reaching for in crucial moments. The bottom has a hook strip for attaching inside compatible bags like the ALS Backpack or AMP Backpacks. Imported.

- + Pull strap for quick detach
- + 7" x 6.5" x 3.5"
- + Clear vinyl / 600D poly

56406 Easy-Vis Med Pouch | 7" x 6.5" x 3.5" | Black 019, Yellow 372, Cherry Bomb 476, Royal Blue 693, Shamrock Green 839 |



TPO II

The Turnout Pocket Organizer II has four padded dividers that keep your critical tools within easy reach. 7.5" x 7" x 0.125". Tools not included. Imported.

56875 TPO II | 474 Fire Red



MED POUCH GEAR SET™

Compatible with our new AMP Backpacks, Operator ALS Backpack, ALS/BLS Duffel and All Missions Plate Carrier

- + 1050D nylon / clear vinyl
- + Fold-out configuration for access to three-tier org system
- + Hook and loop closure on main flap with handle for quick opening
- + Fold out top flap w/elastic bandoliers zipper on back

| **56407 Med Pouch Gear Set** | Black 019 |





ALS/BLS DUFFEL

40L

Gear Set™ compatible (Med Pouch Gear Set™ included), the ALS/BLS Duffel is ideal for fire, rescue and medical professionals who must work quickly and accurately under pressure. You can securely store your tablet in a clear, vinyl top compartment and a front pocket is present for first-grab items. This duffel is durable, too. Constructed with a high abrasion-resistant 1050D nylon body and a waterproof 1000D poly bottom with double sided TPU, it stands up to every test. 21.25" L x 10.5" H x 13.5" D / 3051 cu. in. / 50L capacity. Imported.

- + Tablet compartment
- + Adjustable, single shoulder strap and all metal hardware
- + Reflective pulls and piping
- + Includes Med Pouch Gear Set™

56396 ALS/BLS Duffel | Black 019, Olympian 758 | 50L capacity |



Reinforced, self-standing design with 'lunchbox' style opening and front admin panel. Rigid compartment on right end for sharps, meds or other gear that needs to be protected. Metal hardware, robust grab handles on all corners.



UCR SLINGPACK

The UCR Slingpack is an ambidextrous bag designed for the aware and prepared. Built from 1050D nylon, featuring a drop-front opening with side retention lashes, haul handles, interior pockets with bungee retention, a customizable pull-out ID panel and a large front web patch panel, the UCR Slingpack keeps your gear organized and at hand. Designed to carry a sizable payload of hemorrhage control. Imported.

| **56298 UCR Slingpack** | Black 019 |

BLACK 019



UCR THIGH RIG

Built for carrying up to two blow-out kits, some essentials and a pair of AR magazines, the UCR Thigh Rig features a drop-down zippered compartment with a light-colored interior, bungee tie-downs, and MOLLE- and web platform-compatibility. Crafted from 1050D nylon, with breathable aerospace mesh on the back, this useful rig will faithfully go where you lead – because it's attached to you. Imported.

| **56301 UCR Thigh Rig** | Black 019, Sandstone 328 |

BLACK 019

SANDSTONE 328



UCR IFAK POUCH

Designed to attach to your vehicle's headrest or any MOLLE or web platform, the UCR IFAK Pouch lets you keep a blow-out kit and medical essentials within arm's reach. The pouch features a drop-down zippered compartment with a light-colored interior for easy equipment identification, and bungee tie-downs for added stability. It's nice to know you've got it all right there. Ready to go. Imported.

| **56300 UCR IFAK Pouch** | Black 019, Storm 092, Sandstone 328 |

BLACK 019

STORM 092

SANDSTONE 328



NEW

EMERGENCY READY POUCH

3L

Carry the Emergency Ready Pouch or stage it aboard a vehicle as your intent or mission demands it. Dual zippers provide quick access to an extensively organized interior with dividers, pockets and internal elastic bands to compartmentalize and secure contents. There is also a stretch front pocket for a tourniquet or bandage with clotting agent and a heavy-duty mesh slip pocket at the rear for other necessities. Carry it courier style or around your waist with the adjustable quick-release strap. The Emergency Ready Pouch is constructed of 420D nylon and the base is a formidable N1050D. A 6 in. x 1 in. loop-side tape holder is included for name or callsign tape, squad designator or other hook-back patch. Imported.

- + Main fabric: 420D nylon, base fabric: 1050D nylon
- + 6.25" H x 10" L x 3.75" D

56552 Emergency Ready Pouch | Black 019, Python 256, Night Watch 734 |

BLACK 019

PYTHON 256

NIGHT WATCH 734



NEW

EMERGENCY READY BAG

6L

The Emergency Ready Bag folds open in a partial clamshell to allow full access from the top without letting everything spill out. Once it folds open you'll find the internal partitions stacked one beside the other, with further subdivisions inside them. Dividers, pockets, a stretch woven center zipper pocket and elastic retention bands make it easier to find and access whatever particulars you need to handle your problem. Additional heavy duty slip pockets at the rear and stretch front pockets with internal elastic bands for tourniquets provide additional organizational measures. A 6" x 1" loop-side tape holder is included for name or callsign tape, squad designator or other hook-back patch. Imported.

- + Main fabric: 420D nylon, base fabric: 1050D nylon
- + 8" H x 14" L x 4.75" D

56521 Emergency Ready Bag | Black 019, Python 256, Night Watch 734 |

BLACK 019

PYTHON 256

NIGHT WATCH 734



Multi-layered internal organization including a zippered stretch pocket at the center.



RANGE MASTER SERIES





33L

RANGE MASTER BACKPACK

Stay organized and ready with all your shooting gear safely stored, yet easily accessible. The Range Master Backpack gives you multiple ways to organize your rounds, pistols, mags, holster, belt and other gear. It's sized to fit the included Single Pistol Case, as well as the Small and Medium Range Master Pouches (also included). The external web MOLLE on the front and sides, an outside top pocket, and a rear document pocket let you carry even more essentials. The Range Master Backpack was born to keep your gear, and you, perfectly organized. Imported.

- + Compression molded EVA lid front compartment with internal organization and external name tape
- + Gear loops on bottom panel
- + Includes Pistol Case, small and medium Range Master Pouches
- + 500D nylon, 1680D polyester (lid)
- + 2014 cubic inch / 33-liter total capacity / 20.75"H x 11.5"L x 7.0"D

56496 Range Master Backpack | Includes Small Pouch, Medium Pouch and Single Pistol Case | Slate 096, Ranger Green 186 |

SLATE 096

RANGER GREEN 186



Front compartment (left) features elastic loop organization and compartments. Top compartment (above) features mesh zippered pocket.



Lockable YKK® zippers.



Padded aerospacer mesh.



RANGE MASTER DUFFEL

47L

Rounds, pistols, mags, your holster, belt and more, the Range Master Duffel packs a wallop when it comes to keeping your gear organized. Your options are almost endless. The top features a compression molded EVA lid with name tape and internal mesh pockets, elastic bands and web MOLLE. Inside, there are side elastic bands to securely hold a Single Pistol Case. The Range Master accommodates the 5.11 Single Pistol Case and small and medium Range Master Pouches, which are included in this setup. An external web MOLLE attachment makes customizing your loadout easy, and you can carry this duffel using the removable shoulder strap or with the top or side handles. To have all your shooting gear and accessories well in-hand and within easy reach, the Range Master Duffel rules. Imported.

- + Compression molded EVA top lid with internal org
- + Internal elastic on sides to hold Single Pistol Case
- + Includes Pistol Case, small and medium Range Master Pouches
- + 500D nylon, 1680D polyester (lid)
- + 2868 cubic inch / 47-liter total capacity / 11.5"H x 21.5"L x 11.5"D



Top of lid features elastic loop organization, webbing and zippered mesh pockets.

56495 Range Master Duffel | Includes Small Pouch, Medium Pouch and Single Pistol Case | Slate 096, Ranger Green 186 |

SLATE 096

RANGER GREEN 186



Lockable YKK® zippers.



Molded lid with patchholder strip.



RANGE MASTER QUALIFIER

Load up the Range Master Qualifier for a full day at the range and then some. Bring your rounds, pistols, mags, your holster, belt and more. The Qualifier houses the 5.11 Single Pistol Case and the medium Range Master Pouch, which are included. An external web MOLLE attachment makes customizing your setup easy, and you can carry this case with a removable shoulder strap or with the top or side handles. To have all your shooting gear and accessories well in-hand and within easy reach, the Range Master Qualifier packs a punch when it comes to keeping your gear organized. Imported.

- + Compression molded EVA top lid with internal org
- + Internal elastic on sides to hold single pistol case
- + Includes Pistol Case, small and medium Range Master Pouches
- + 500D nylon, 1680D polyester (lid)
- + 1647 cubic inch / 27-liter total capacity / 9.75"H x 12.5"L x 11.5"D

56542 Range Master Qualifier | Includes Medium Pouch and Single Pistol Case | Slate 096, Ranger Green 186 |

SLATE 096

RANGER GREEN 186



Top of lid features elastic loop organization, webbing and zippered mesh pocket.



Lockable YKK® zippers.



Molded lid with patchholder strip.



RANGE MASTER POUCH (LARGE)

10L

Range Master Pouch (Large) offers quick and reliable access to mags, rounds, and more. Its 10-liter capacity holds your vital accessories, and it fits inside the Range Master Duffel, Qualifier and Backpack. Imported.

- + Padding on top panel and padding with PE board on bottom
- + Loop for name tape or 5.11 Writebar patch
- + 500D nylon
- + 4.5"H x 11.0"L x 9.0"D / 610 cubic inch / 10-liter total capacity

| 56499 Range Master Pouch (Large) | Black 019, Python 256 |

BLACK 019

PYTHON 256



RANGE MASTER PADDED POUCH (MEDIUM)

4L

For quick and reliable access to mags, rounds, and more, the Range Master Padded Pouch (Medium) is the ideal size to store, and stow. It easily and securely fits inside the Range Master Duffel, Qualifier and Backpack. Imported.

- + Padding on top, sides and bottom panels with PE bottom board
- + Loop for name tape or 5.11 Writebar patch
- + 500D nylon
- + 4.5"H x 9.0"L x 5.5"D, 244 cubic inch / 4-liter total capacity

| 56500 Range Master Padded Pouch (Medium) | Black 019, Python 256 |

BLACK 019

PYTHON 256



RANGE MASTER POUCH (SMALL)

1.5L

For quick and reliable access to mags or rounds, the Range Master Pouch (Small) is the ideal size to store, and stow. It easily and securely nests inside the Range Master Duffel, Qualifier and Backpack. Imported.

- + Padding on top panel and padding with PE board on bottom
- + Loop for name tape or 5.11 Writebar patch
- + 500D nylon
- + 4.0"H x 5.5"L x 4.5"D / 92 cubic inch / 1.5-liter total capacity

| 56497 Range Master Pouch (Small) | Black 019, Python 256 |

BLACK 019

PYTHON 256



RANGE MASTER POUCH (MEDIUM)

4L

For quick and reliable access to mags, rounds, and more, the Range Master Pouch (Medium) is the ideal size to store, and stow. It easily and securely fits inside the Range Master Duffel, Qualifier and Backpack. Imported.

- + Padding on top panel and padding with PE board on bottom
- + Loop for name tape or 5.11 Writebar patch
- + 500D nylon
- + 4.5"H x 9.0"L x 5.5"D / 244 cubic inch / 4-liter total capacity

| 56498 Range Master Pouch (Medium) | Black 019, Python 256 |

BLACK 019

PYTHON 256



NEW

RANGE MASTER BUCKET BAG

4L

Constructed from durable 1050D Nylon on the base and 500D Nylon for the primary compartment, the Range Master Bucket Bag is a drawstring closure bag with cord lock and top carry handle. Carry unboxed ammunition, a whole harvest of magazines or collect your brass in it. Gas 'em up when you need to. Imported.

- + Main fabric: 500D nylon, base fabric: 1050D nylon
- + Stackable bucket bag design
- + Durable bottom panel
- + 8" H x 4" L x 4" D

56534 Range Master Bucket Bag | 4-liter (244 cu. in.) | Black 019, Python 256 |

BLACK 019

PYTHON 256



KIT BAGS

VAC
TESTED

8L

16L

One of the most versatile items in the 5.11 catalog, the Kit Bag is a robust storage option for your tools, range gear, camera equipment, first aid kit or toiletries. Built from rugged 1050D nylon, featuring fold-out organizational panels and zippered mesh pockets, your gear will be ready for the road. Imported.

58725 Small Kit Bag | Black 019 | Main compartment 6" x 10" x 5.25", front and back compartments 5" x 8" x 2" |

58726 Large Kit Bag | Black 019 | Main compartment 8" x 13" x 6", front and back compartments 7.25" x 11.5" x 2" |





RANGE READY™ & RANGE QUALIFIER™

43L 18L

We take range time seriously. That's why our Range Ready™ Bag, built from rugged 600D nylon, includes separate padded storage for multiple handguns and a zip-down front organizer for eight magazines. The removable ammo tote and side pockets will keep you topped off, while a removable brass tote holds spent casings. We included a padded shoulder strap and sturdy handles to provide easy transport to your lane. If you prefer a medium-sized range bag, the Range Qualifier™ is a perfect alternative. Imported.

59049 Range Ready | 43L Capacity | Black 019, Sandstone 328 | 24" x 16" x 10" (61 cm x 41 cm x 25 cm) |

56947 Range Qualifier | 18L Capacity | Black 019, Sandstone 328 | 8-3/4" x 13" x 10-1/4" (22 cm x 33 cm x 26 cm) |



SINGLE PISTOL CASE

Constructed from tough 1050D nylon, the 5.11® Single Pistol Case protects your favorite sidearm inside the padded compartment. Heavy-duty elastic straps hold your magazines and accessories in place, while lockable wrap-around zippers offer added security. The reinforced grab-and-go handles will withstand years of heavy training. Add your name to the external WriteBar™ and you're ready for the range. Imported.

58724 Single Pistol Case | Black 019, Tac OD 188, Sandstone 328 |

58724G7 GE07™ Single Pistol Case | Night 357, Terrain 865 |

BLACK 019

DOUBLE TAP 026

TAC OD 188

SANDSTONE 328

GE07 NIGHT 357

GE07 TERRAIN 865



DOUBLE PISTOL CASE

If you train with more than one sidearm, you need the 5.11® Double Pistol Case. Built from durable 1050D nylon, the Double Pistol Case allows you to safely and securely transport two handguns. Heavy-duty elastic straps keep multiple magazines and accessories in place, while lockable YKK® zippers provide added security. The external WriteBar™ nametape helps prevent any mix-ups at the range. Imported.

56444 Double Pistol Case | Black 019, Kangaroo 134, Ranger Green 186 |

BLACK 019

KANGAROO 134

RANGER GREEN 186

29"
INTERNAL LENGTH



32"
INTERNAL LENGTH



LV M4 SHORTY & LV M4

The LV M4 rolls how you need to roll, as a backpack or a crossbody bag and is available in a 32" or 29" internal height measurement. This pack makes it easy to stay organized, too. Its front compartment features a laser-cut loop panel and internal mesh pocket. There's a top fleece-lined pocket to keep your eye protection secure, or flip the pocket inside out to hold your ID panel/patch. Imported.

- + Removable shoulder straps convert from backpack to slingpack with crossbody strap
- + Discrete/tuckable logos
- + 840D Nylon
- + LV M4: 32" internal length / LV M4 Shorty: 29" internal length

56474 LV M4 Shorty | Black 019, Tarmac 053, Night Watch 734 | 29" internal length |

56438 LV M4 | Black 019, Tarmac 053, Night Watch 734 | 32" internal length |

BLACK 019

TARMAC 053

NIGHT WATCH 734



44"
INTERNAL LENGTH

38"
INTERNAL LENGTH

VTAC® DOUBLE RIFLE CASES



Field-tested by Viking Tactics®, the VTAC® Double Rifle Case has a rugged 1050D nylon shell, 500D nylon ripstop interior and lockable zippers. A padded divider and rifle tie-downs protect against dings and accidental impact, and a simplified front compartment features a full-sized web platform and MOLLE-compatibility for easy, customizable organization. Complete with muzzle and stock pockets, an adjustable shoulder strap, backpack straps, an ID window and a WriteBar™, the VTAC Double Rifle Case is stuffed with features. Now it's time to stuff it with your gear. Imported.

56221 Double 36" Rifle Case | Black 019, Sandstone 328 |

56222 Double 42" Rifle Case | Black 019 |

BLACK 019

SANDSTONE 328



Padded yoke backpack straps make carrying a heavy load comfortable.



Interior padded divider prevents rifles from damaging each other in transit.



44"
INTERNAL LENGTH

38"
INTERNAL LENGTH

SHOCK RIFLE CASES

Available in 36" and 42" sizes, the Shock Rifle Case features a stout 600D polyester shell and a padded interior lined with 300D polyester. Also comes with internal retention straps, lockable main compartment zippers, an adjustable shoulder strap that converts to a simple backpack system, ID window and Write Bar. Imported.

56219 Shock 36" Rifle Case | Black 019, Sandstone 328 |

56220 Shock 42" Rifle Case | Black 019 |

BLACK 019

SANDSTONE 328



Shoulder strap converts to backpack straps.



Corner protection and built-in retention straps.

LOAD READY

Load them up with your camp gear, construction tools and equipment or even just your groceries. The Load Ready collection is built to haul it all.



LOAD READY HAUL PACK
(35-LITER CAPACITY)

LOAD READY UTILITY MEDIUM
(19-LITER CAPACITY)

LOAD READY UTILITY LARGE
(39-LITER CAPACITY)

LOAD READY UTILITY MEDIUM TALL
(26-LITER CAPACITY)

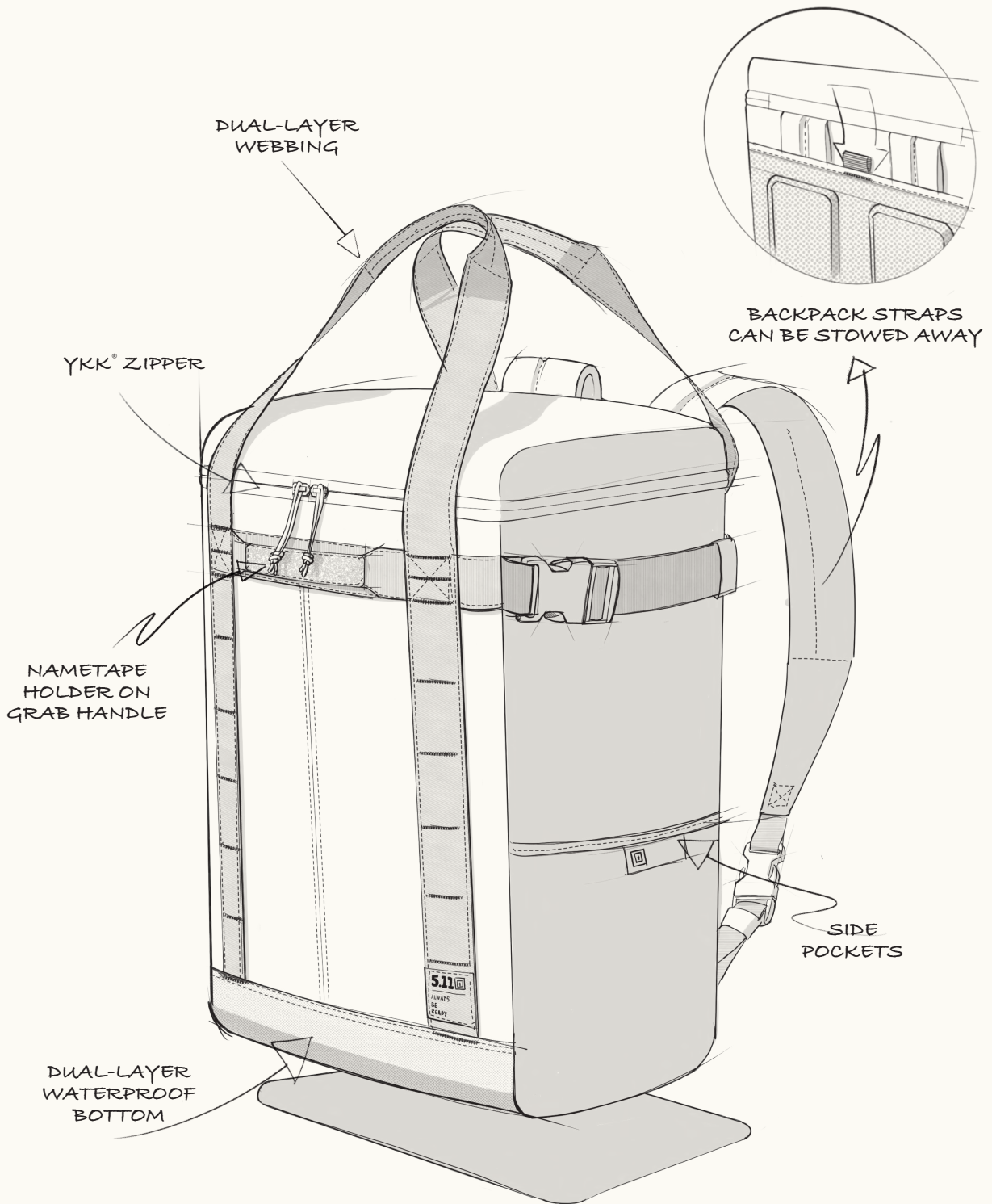



NEW

LOAD READY HAUL PACK

35L

Constructed from durable 1050D nylon and featuring a 1000D polyester base with waterproof TPU coating, the Load Ready Haul Pack is an ultra-heavy-duty convertible haul-all. Load what you need then carry it in either backpack or tote/duffel configuration. For open access, roll up and store the top lid with toggle/loop, or roll it back down and secure it to secure your cargo. The pack is protected on the bottom by a dual-layer waterproof panel and is sewn with extra-heavy-duty thread and reinforced with numerous bartacks. Imported.

- + Main fabric: 1050D nylon, base: 1000D polyester with TPU coating
- + 19.5" H x 12" L x 9.0" D
- + 5.11's signature Centerline™ design
- + Internal zippered mesh pocket
- + Grab handle with name tape

56528 Load Ready Haul Pack | 35-liter (2135 cu. in.) | Smoke Grey 009, Kangaroo 134, Ranger Green 186 |

SMOKE GREY 009

KANGAROO 134

RANGER GREEN 186



NEW

LOAD READY UTILITY LARGE

39L

The Load Ready Utility Large is a heavy-duty, haul-all stackable utility bag. Built with 1050D nylon and boasting a dual layer internal and external waterproof TPU base, this Utility Bag can be manhandled by using reinforced side grab handles. Or, secure them together with front, rear and corner external lash loops. Separate specific smaller items internally with the inside mesh pocket. Tough, dual-layered waterproof bottom for durability and protection for your gear. Imported.

- + Main fabric: 1050D nylon, base: 1000D polyester with TPU coating
- + 12" H x 18" L x 11" D
- + 5.11's signature Centerline™ design
- + Internal mesh pocket
- + Side grab handles with name tape

56533 Load Ready Utility Large | 39-liter (2380 cu. in.) | Smoke Grey 009, Kangaroo 134, Ranger Green 186 |

SMOKE GREY 009

KANGAROO 134

RANGER GREEN 186





NEW

LOAD READY UTILITY MEDIUM TALL

26L

Constructed from durable 1050D nylon and featuring a P1000D base with waterproof TPU coating, the Load Ready Utility Tall is a heavy duty, stackable utility bag. Front, rear and corner external lash loops mean you can secure multiple Load Ready Bags in your truck bed or car trunk. Whatever you actually load these bags with, you'll be able to move it as needed with reinforced side grab handles and set it where you need to without worrying about moisture. The bottom is built with an internal and external dual-layer waterproof panel. Bring on the heavy cargo. Imported.

- + Main fabric: 1050D nylon, base: 1000D polyester with TPU coating
- + 16" H x 11" L x 9" D
- + 5.11's signature Centerline™ design
- + Internal mesh pocket
- + Side grab handles with name tape

56532 Load Ready Utility MD Tall | 26-liter (1587 cu. in.) | Smoke Grey 009, Kangaroo 134, Ranger Green 186 |

SMOKE GREY 009

KANGAROO 134

RANGER GREEN 186



NEW

LOAD READY UTILITY MEDIUM

19L

Constructed from durable 1050D nylon and featuring a 1000D polyester base with waterproof TPU coating, the Load Ready Utility Medium is a heavy-duty, stackable utility bag. Load it down and haul it, stash it away in a shed or car trunk until needed. The Load Ready Utility Bags are equipped with side grab handles, a roll-up heavy-duty mesh top with a toggle for stowing, and an internal mesh pocket for small item segregation. The bottom is built with a dual-layer, internal and external, waterproof panel, and its already robust construction has been reinforced with heavy-duty thread and extra bartacks. Imported.

- + Main fabric: 1050D nylon, base: 1000D polyester with TPU coating
- + 12" H x 11" L x 9" D
- + 5.11's signature Centerline™ design
- + Internal mesh pocket
- + Side grab handles with name tape

56531 Load Ready Utility Medium | 19-liter (1159 cu. in.) | Smoke Grey 009, Kangaroo 134, Ranger Green 186 |

SMOKE GREY 009

KANGAROO 134

RANGER GREEN 186



5.11 PERFORMANCE FABRICS	6
5.11 FABRIC FEATURES	6
FAVORITE FEATURES	7
OPS CENTER OVERVIEW	10
CUSTOM SHOP 2.0	11

MEN'S APPAREL 68

DEFENDER FLEX RANGE PANT	14
DEFENDER FLEX URBAN PANT	15
DEFENDER FLEX JEAN SLIM FIT	16
DEFENDER FLEX JEAN STRAIGHT FIT	17
CAPITAL PANT	18
QUEST PANT	19
ICON PANT	22
5.11 STRYKE® PANT	23
APEX™ PANT	26
ABR™ PRO PANT	27
TACLITE® PRO PANT	27
DELTA PANT	28
BRAVO PANT	29
EDGE CHINO	29
FAST-TAC™ CARGO PANT	30
FAST-TAC™ URBAN PANT	30
5.11 TACTICAL® PANT	31
5.11 RECON® POWER TRACK PANT	31
APEX™ SHORT	34
ABR™ PRO SHORT	35
STEALTH SHORT	35
5.11 STRYKE® SHORT	36
FAST-TAC URBAN SHORT	38
BASE SHORT	38
TACLITE® PRO SHORT	39
5.11 TACTICAL® SHORT	39
UTILITY PT SHORT	40
RANGE READY™ MERINO WOOL BRIEFS	40
PERFORMANCE BRIEFS	40
5.11 RECON® SHIELD TIGHT	41
RANGE READY™ MERINO WOOL TIGHT	41
HAWTHORN LONG-SLEEVE SHIRT	44
MARKSMAN LONG-SLEEVE SHIRT	45
ALPHA FLEX SHIRTS	45
5.11 STRYKE® SHIRTS	46
TACLITE PRO® SHIRTS	47
5.11 TACTICAL® SHIRTS	47
FAST-TAC™ SHIRTS	48
FREEDOM FLEX™ LONG-SLEEVE SHIRT	49
HI-VIS PERFORMANCE SHIRT	49
CONTENDER LONG-SLEEVE SHIRT	50
RAPID OPS SHIRT	51
RAPID HALF-ZIP	51
CARSON SHORT-SLEEVE SHIRT	52
VENTURE SHORT-SLEEVE SHIRT	53
TANGO SHORT-SLEEVE SHIRT	53
FREEDOM FLEX™ SHORT-SLEEVE SHIRT	54
FLEX-TAC TWILL SHORT-SLEEVE SHIRT	54
PARAMOUNT POLO	55
PROFESSIONAL POLOS	56
TACTICAL POLOS	57

HELIOS POLOS	57
PERFORMANCE POLOS	58
UTILITY POLOS	59
REFLEX POLO	60
RAPID PERFORMANCE POLO	61
PINNACLE POLO	61
RANGE READY™ MERINO WOOL TOPS	62
RANGE READY™ TOPS	62
CAMS SHORT-SLEEVE BASE LAYER	63
UTILITY PT SHIRT	63
5.11 RECON® CHARGE SHORT-SLEEVE TOP	64
PERFORMANCE UTILI-T (2 PACK)	64
UTILI-T	65
STATION WEAR TEES	65
PROFESSIONAL TEES	66
5.11® TIGHT FIT CREW	67
5.11® LOOSE FIT CREW	67

MEN'S OUTERWEAR 68

3-IN-1 PARKA™	70
AGGRESSOR PARKA	70
BRISTOL PARKA	71
5-IN-1 JACKET™	71
VALIANT DUTY JACKET	72
SIGNATURE DUTY JACKET	72
DOUBLE-DUTY JACKET™	73
4-IN-1 JACKET	73
RESPONDER PARKA	74
FIRST RESPONDER PARKA	74
HIGH VIS RESPONDER PARKA	75
FIRST RESPONDER HIGH VIS PARKA	75
REVERSIBLE LONG HIGH VIS RAIN COAT	76
REVERSIBLE HIGH VIS 3-IN-1 PARKA™	76
BIKE PATROL JACKET	77
5-POINT BREAKAWAY VEST	77
XPRT® WATERPROOF PANT	78
XPRT® WATERPROOF JACKET	78
APPROACH JACKET	79
SABRE JACKET 2.0	79
SIERRA SOFTSHELL	81
CHAMELEON SOFTSHELL JACKET	82
BIG HORN JACKET	83
RESPONSE JACKET™	83
TACTICAL FLEECE	84
JOB SHIRTS	84
DUTY RAIN SHELL	85
TAC DRY® RAIN SHELL	86
PATROL RAIN PANT	86
PACKABLE JACKET	87
PACKABLE OPERATOR JACKET	87
PENINSULA HYBRID JACKET	89
PENINSULA INSULATOR JACKET	90
PENINSULA INSULATOR SHIRT JACKET	90
RAPPEL JACKET	91
APOLLO TECH FLEECE	91
BRAXTON JACKET	93
REVOLVER REVERSIBLE JACKET	93
SURPLUS JACKET	95

CRUISER HOODIE	96	JOB SHIRTS	151
PACKABLE RAID VEST	96	LOGOWEAR	152
COVERT VEST	97	PATCHES	154
TACLITE PRO VEST	97	HATS PLUS SOCK & AWE	156
WOMEN'S	98	T-SHIRTS	158
WOMEN'S APEX™ PANT	101	ABOUT 5.11	160
WOMEN'S 5.11 STRYKE® PANT	102	FOOTWEAR	162
WOMEN'S ICON PANT	103	5.11® A.T.L.A.S. SYSTEM	166
WOMEN'S ABR™ PRO PANT	105	5.11® A.T.L.A.S. TRAINER	166
WOMEN'S TACLITE® PRO PANT AND SHORT	106	5.11® A.T.L.A.S. MID	166
WOMEN'S 5.11 TACTICAL® PANT	106	5.11® A.T.L.A.S. 8" SZ	167
WOMEN'S FAST-TAC™ CARGO PANT	107	5.11® A.T.L.A.S. 8" NZ	167
WOMEN'S FAST-TAC™ URBAN PANT	107	APEX™ 8" WATERPROOF	168
AVALON PANT	109	APEX™ 8"	168
VISTA PANT	110	APEX™ 6" WEDGE	169
ASCENT PANT	110	A.T.A.C.® 2.0 COLLECTION	170
NATASHA TIGHT	111	A.T.A.C.® 2.0 8" SZ	170
HARPER TIGHT	112	A.T.A.C.® 2.0 8" STORM	171
WOMEN'S FREEDOM FLEX SHIRT	114	A.T.A.C.® 2.0 6" SZ	171
WOMEN'S 5.11 STRYKE® SHIRTS	114	A.T.A.C.® 2.0 8" SHIELD	171
WOMEN'S FAST-TAC™ SHIRTS	115	A.T.A.C.® 2.0 6" NZ	171
WOMEN'S TACLITE® PRO SHIRT	115	A.T.A.C.® 2.0 8" ARID	172
WOMEN'S RAPID HALF-ZIP	116	A.T.A.C.® 2.0 6" SZ DESERT	172
ATLAS JACKET	116	A.T.A.C.® 2.0 8" DESERT	172
EMMA FULL ZIP	117	A.T.A.C.® 2.0 6" NZ DESERT	172
UNIFORMS	118	FAST-TAC® COLLECTION	173
CLASS A FLEX-TAC POLY/WOOL SHIRTS	123	FAST-TAC® 6"	173
CLASS A FLEX-TAC POLY/WOOL PANTS	123	FAST-TAC® 8" DESERT	173
5.11 STRYKE® PDU® PANT	124	FAST-TAC® 8"	173
5.11 STRYKE® PDU® SHIRT	125	FAST-TAC® 6" WATERPROOF	173
5.11 STRYKE® PDU RAPID SHIRT	125	FAST-TAC® 6" DESERT	173
NYPD 5.11 STRYKE® PANT	126	EVO COLLECTION	174
CLASS A FAST-TAC® TWILL SHIRTS	127	EVO 8" CST	174
CLASS A FAST-TAC® TWILL PANTS	127	EVO 8"	174
MOTORCYCLE BREECHES	128	EVO 6 WATERPROOF™	174
BIKE PATROL ZIP-OFF PANT	129	EVO 6"	175
PATROL SHORT	129	EVO 8" DESERT	175
5.11 S.A.F.E.™ BADGES	130	EVO 8" WATERPROOF	175
PATROL DUTY UNIFORM® PANTS	133	EVO 8" INSULATED	175
PATROL DUTY UNIFORM® SHIRTS	133	SPEED 3.0 COLLECTION	176
UNIFORM OUTER CARRIERS	134	SPEED 3.0 8" RAPIDRY	176
HEXGRID® UNIFORM OUTER CARRIERS	135	SPEED 3.0 8" SZ	176
XPRT® TACTICAL SHIRT	137	SPEED 3.0 5"	176
XPRT® TACTICAL PANT	137	SPEED 3.0 8" WATERPROOF	177
XPRT® RAPID SHIRT	137	SPEED 3.0 8" DESERT	177
5.11 STRYKE® TDU® SHIRTS	139	SPEED 3.0 8" SHIELD CST	177
5.11 STRYKE® TDU® PANT	139	SPEED 3.0 8" JUNGLE	177
QUANTUM TDU® SHIRT	141	COMPANY BOOTS	178
QUANTUM TDU® PANT	141	COMPANY 3.0	178
TDU® PANT	144	COMPANY 2.0™	178
TDU® SHIRT	145	COMPANY 3.0 CST	178
RAPID ASSAULT SHIRT	145	COMPANY 2.0™ CST	178
5.11 STRYKE® EMS PANT	147	SKYWEIGHT 8" WATERPROOF SZ	179
EMS PANT & EMS SHORT	147	MOTO BOOT	179
COMPANY SHIRTS	149	XPRT® 3.0 6" WATERPROOF	180
COMPANY PANT 2.0	149	UNION 6" WATERPROOF	181

CABLE HIKER TACTICAL	181
NORRIS SNEAKER	182
MISSION READY™ OXFORD	183
MISSION READY™ CHUKKA	183
CUPRON® YEAR ROUND SOCKS	184
MERINO WOOL SOCKS	184
CUPRON® 3-PACK SOCKS	184
YEAR-ROUND SOCKS	184
SLIPSTREAM SOCKS	185
LEVEL 1 SOCKS	185
REPLACEMENT PARACORD LACES	185
5.11 TACLITE™ SOCKS	185
3-PACK SOCKS	185

EDC & TOOLS 186

MAVERICK ASSAULTERS BELT	188
TRAINER AND OPERATOR BELTS	188
ALTA BELT	188
SKYHAWK 1.5" BELT	188
TDU® BELT	189
LOW PRO TDU® BELT	189
DOUBLE-DUTY TDU® BELT	189
PRINTED LOW PRO TDU® BELT	189
ELAS-TAC BELT	190
TRAVERSE® DOUBLE BUCKLE BELT	190
DROP SHOT BELT	190
SI WEB BELT	190
APEX GUNNER BELT	191
MISSION READY™ BELT	191
ARC LEATHER BELT	191
MISSION READY™ CASUAL BELT	191
STAY SHARP LEATHER BELT	192
1.5" LEATHER BASKETWEAVE BELT	192
REVERSIBLE BELT	192
1.5" LEATHER CASUAL BELT	192
FIELD WATCH	193
KUBATON TACTICAL PEN	193
DOUBLE DUTY PEN 1.5	193
CFX 3.4 NYLON BADGE WALLET	194
TRACKER BIFOLD WALLET	194
PHANTOM BIFOLD WALLET	194
CAMO BIFOLD WALLET	194
BIFOLD WALLET	194
STATUS BIFOLD WALLET	194
STANDBY CARD WALLET	195
QR CARD WALLET	195
EXCURSION CARD WALLET	195
CAMO CARD WALLET	195
STEEL JACKET MULTI-TOOL WALLET	195
MULTITOOL MONEY CLIP	195
ESC RESCUE TOOL	196
TKO RATCHET KIT	196
LE EMT MULTI-TOOL	196
HARDPOINT M3	197
HARDPOINT MK1	197
HARDPOINT M2	197
EDT MULTITOOL	197
VTAC® OPERATOR AXE	198

CFK FIELD KNIVES	198
FERRO KNIFE	199
HERON KNIFE	199
TANTO SURGE KNIFE	199
KARAMBIT FOLDER	199
INCEPTOR CURIA KNIFE	199
EDC 2AAA	200
EDC PL 2AAA	200
EDC PL 1AAA	200
EDC PLUV 1AAA	200
EDC L2	201
STATION 2AA	201
STATION 4AA	201
STATION 3D	201
RAPID L1	202
RAPID L2	202
RAPID PL 1AA	202
RAPID PL 2AA	202
RESPONSE CR1	203
RESPONSE XR1	203
RESPONSE XR2	203
RESPONSE XR CHARGING KIT	203
RAPID HL 1AA	204
RESPONSE HL XR1	205
HIGH ABRASION TAC GLOVE	206
TACLITE 3	206
STATION GRIP 2	206
COMPETITION SHOOTING GLOVE	206
ROPE K9 GLOVE	207
HARD TIMES 2 GLOVE	207
TAC-CR CUT RESISTANT GLOVE	207
BATTALION FR GLOVE	207
FOXTROT FR GLOVE	207
CALDUS GLOVE	207
EXO.K GEL KNEE PAD	208
EXO.K1 KNEE PAD	209
EXO.E1 ELBOW PAD	209
NEOPRENE KNEE PAD	209
ENDO.K INTERNAL KNEE PAD	209
HEAVY BREACHING KIT	210
TRAINING DOOR	210
ACTIVE PATROL KIT	210
CARRAKE	211
EDGE BENDER 2.0	211
GRYPHON BREAK 'N RAKE	211
MINIRAM	211
MULTIPRY	211
MULTIBREACHER	211
MULTISLEDGE	211
MEDIUM RAM	211

LOADBEARING 212

GE07™ ITEMS	213
ALL MISSIONS PLATE CARRIER	214
ALL MISSIONS RIG	215
DOUBLE DEPLOY GEAR SET™	216
LASER-CUT MOLLE™	216
AMP COVERT PANEL	216

HEXGRID® 9X9 GEAR SET™	217	RUSH DELIVERY MESSENGERS	249
HEXGRID® 12X9 GEAR SET™	217	COVRT18™ BACKPACK	250
HELMET/SHOVE-IT GEAR SET™	217	RAPID EXCURSION PACK	250
2 BANGER GEAR SET™	218	SELECT CARRY PACK™	251
ADMIN GEAR SET™	218	MORALE PACK	251
MED POUCH GEAR SET™	219	LV18	252
UTILITY 9X9 GEAR SET™	219	LV10	253
TACTEC™ PLATE CARRIER	220	LV6	253
PRIME PLATE CARRIER	221	DART PACK	254
TACLITE PLATE CARRIER	222	DART24 PACK	254
LBE VEST	222	DART DUFFEL	255
TACTEC® CHEST RIG	223	RAPID QUAD-ZIP PACK	256
VTAC® COMBAT BELT & THIGH RIG	223	RAPID ORIGIN PACK	256
VTAC® TWO-POINT SLINGS	223	MIRA CROSSBODY BAG	257
VTAC® SINGLE-POINT SLING	223	MIRA 2-IN-1 BACKPACK	257
COVERT INSERT	224	CAMS™ 3.0	258
HEXGRID® INSERT	224	SOMS™ 3.0	259
VEHICLE READY HEXGRID® PLATFORMS	225	MISSION READY™ 3.0	260
FLEX-HT™ POUCHES	226	LOAD UP 22" CARRY ON	261
FLEX SINGLE PISTOL MAGAZINE POUCH	226	CONVOY PACKING CUBES	262
FLEX SINGLE AR MAGAZINE POUCH	226	CONVOY STUFF SACKS	263
FLEX ADMIN POUCH	226	CONVOY DOPP KIT	263
FLEX DOUBLE PISTOL MAGAZINE POUCH	226	JOEY POUCHES	263
FLEX DOUBLE AR MAGAZINE POUCH	226	BASIC PATROL BAG	264
FLEX RADIO POUCH	226	PATROL READY™ BAG	264
FLEX MEDIUM GP POUCH	227	WINGMAN PATROL BAG™	265
FLEX VERTICAL GP POUCH	227	SIDE TRIP™ BRIEFCASE	265
FLEX DROP POUCH	227	OPERATOR ALS BACKPACK	267
FLEX MED POUCH	227	TAC OPERATOR ALS BACKPACK	267
FLEX RESCUE POUCH	227	EASY-VIS MED POUCH	268
FLEX LOOP PANEL	227	TPO II	268
FLEX HOOK ADAPTER	227	MED POUCH GEAR SET™	268
VTAC® POUCHES	228	ALS/BLS DUFFEL	269
SIERRA BRAVO DUTY BELT SYSTEM	231	UCR SLINGPACK	270
ZERO-G LOAD-BEARING PLATES	231	UCR THIGH RIG	270
AMPC PACK	234	UCR IFAK POUCH	270
AMP10™	235	EMERGENCY READY POUCH	271
AMP12™	236	EMERGENCY READY BAG	271
AMP24™	237	RANGE MASTER BACKPACK	273
AMP72™	238	RANGE MASTER DUFFEL	274
AMP PACK SIZE COMPARISON	239	RANGE MASTER QUALIFIER	275
RUSH12™	241	RANGE MASTER POUCH (LARGE)	276
RUSH24™	242	RANGE MASTER PADDED POUCH (MEDIUM)	276
RUSH72™	243	RANGE MASTER POUCH (SMALL)	276
ALL-HAZARDS NITRO	244	RANGE MASTER POUCH (MEDIUM)	276
ALL-HAZARDS PRIME	244	RANGE MASTER BUCKET BAG	277
RUSH LBD DUFFELS	245	KIT BAGS	277
RED 8100 DUFFEL	245	RANGE READY™ & RANGE QUALIFIER™	278
RUSH TIER SYSTEM	246	SINGLE PISTOL CASE	278
WRITEBAR™ NAME TAPES	246	DOUBLE PISTOL CASE	278
RUSH TIER SCABBARD	246	LV M4 SHORTY & LV M4	279
SIDEWINDER STRAPS	246	VTAC® DOUBLE RIFLE CASES	280
BAILOUT BAG	247	SHOCK RIFLE CASES	281
PUSH™ PACK	247	LOAD READY HAUL PACK	284
2-BANGER BAG	247	LOAD READY UTILITY LARGE	284
4-BANGER BAG	247	LOAD READY UTILITY MEDIUM TALL	285
MOAB™ 6	248	LOAD READY UTILITY MEDIUM	285
MOAB™ 10	248		