

Right Tapes. Right System. Right Partner.



190

3M Packaging Solutions Guide





At 3M, we never forget our success was sealed by a roll of tape.

A single inventive way of solving a customer's problem more than 86 years ago led to a breakthrough that became known as **"Scotch® Tape"; an invention that changed the world.** Today, the curious minds at 3M continue to maintain the legacy of the original Scotch® Tape by meeting customer needs everyday and never compromising on performance.

Reliable performance proven over time has formed a bond of trust with Scotch® Tape. This is why it remains the number one brand for packaging, bundling, reinforcing solutions and more. At 3M, Scotch® Tape isn't "just tape." It's the crown jewel which built our reputation for uncompromising quality and innovation. We stake our reputation on delivering the very best, most reliable tapes every day so you can trust Scotch® Tape to protect your reputation, as well.

You can double down on dependability by combining Scotch® Box Sealing Tapes with 3M-Matic™ Case Sealers. With nearly a half-century of experience in building case sealing equipment, 3M delivers the "total package" in packaging systems.

In a world where so many unexpected events can impact your results, Scotch® Tapes and 3M packaging solutions have got you covered — with dependable, high quality products and systems to meet your ever-changing requirements.

RIGHT RIGHT
TAPES. SYSTEM.
RIGHT PARTNER.

3M

Scotch

3M-Matic
Case Sealing Systems

The most trusted names in packaging systems

3M Packaging Solutions

Table of Contents

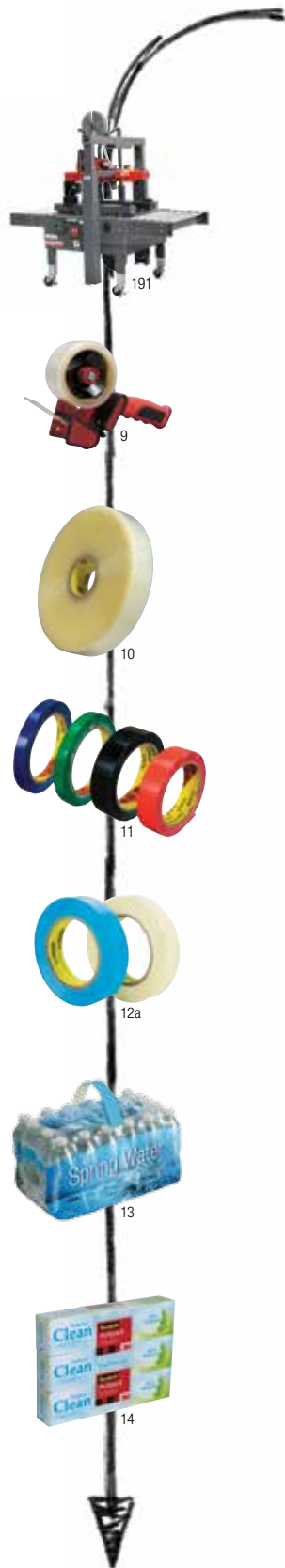

Packaging Equipment and Dispensers

3M-Matic™ Case Sealers Selection Overview.....	5–7
3M-Matic™ Adjustable Case Sealers	8–9
3M-Matic™ Random Case Sealers	10
3M™ AccuGlide™ Taping Head Technology	11
Customized 3M-Matic™ Equipment.....	11
Non-RSC Closure Solutions.....	12
3M-Matic™ Case Sealers Replacement Parts and Accessories.....	13
Scotch® Tape Dispensers	14–15
3M Systems Tape Agreement	16

Box Sealing Tapes

Scotch® and Tartan™ Box Sealing Tapes	18–20
Scotch® Box Sealing Tapes	20
Scotch® Recycled Corrugate Tapes.....	20
Tartan™ Box Sealing Tapes.....	20
Scotch® Specialty Box Sealing Tapes.....	21
Cold Temperature Tapes	21
Custom Printed Tapes.....	21
Security Tapes	21
Water Activated Tapes	21
Light Duty Packaging Tapes.....	22–23

High Strength Tapes

High Strength Tapes Overview.....	25
High Strength Filament Tapes	26–27
Tensilized Polypropylene Tapes	28
Scotch® Reinforced Strapping Tapes	29
Scotch® Stretchable Tapes	30

Custom Packaging Solutions

3M™ Carry Handles.....	32
Scotch® Multipack Tapes.....	33
Bag Sealing Tapes.....	34
3M™ Tape Pads	34
Scotch® Bag Conveying Tapes	35
3M™ Hang Tabs.....	35
Scotch® Pouch Tapes	36
Label Protection Tapes	36
3M™ Packing List Envelopes.....	37
Remote Sensing Tapes	38
Scotch® Tear Strip Tapes	39

Glossary.....	40–41
---------------	-------

Numerical Index.....	42–43
----------------------	-------

Product Name Index	44–45
--------------------------	-------

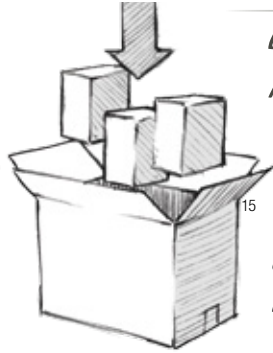

ERECTING & PACKING

CASE ERECTORS
ERGO PACKS

THROUGHPUT & SPEED



CONSISTENCY
SECURITY
PROTECTION

3M™ ACCUGLIDE™ TAPE
HEAD TECHNOLOGY

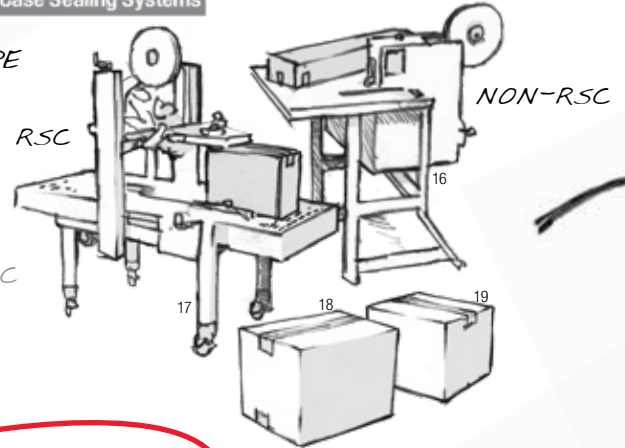

SEALING

SEMI-AUTOMATIC
HAND APPLIED
BAG SEALING



RECYCLED
CORRUGATE?
NO PROBLEM!



PROTECTION
CONTROL
SECURITY

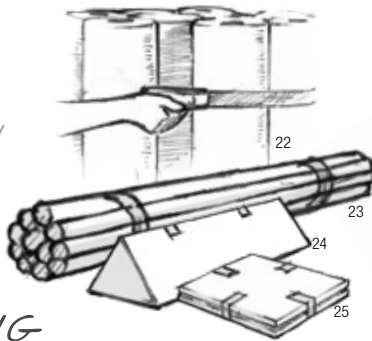

BUNDLING

L-CLIP CLOSURE

PACKING STATIONS

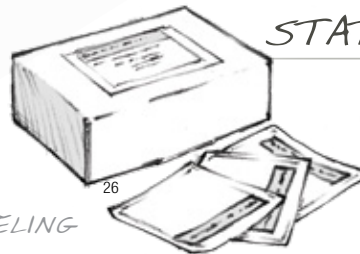

LABELING
EASE OF USE

DOCUMENT
ATTACHMENT
LABEL PROTECTION
PATCHING

TECH SUPPORT
BEFORE &
AFTER THE SALE



The Total Package

Pack it. Close it. Move it. Sell it. Use it.

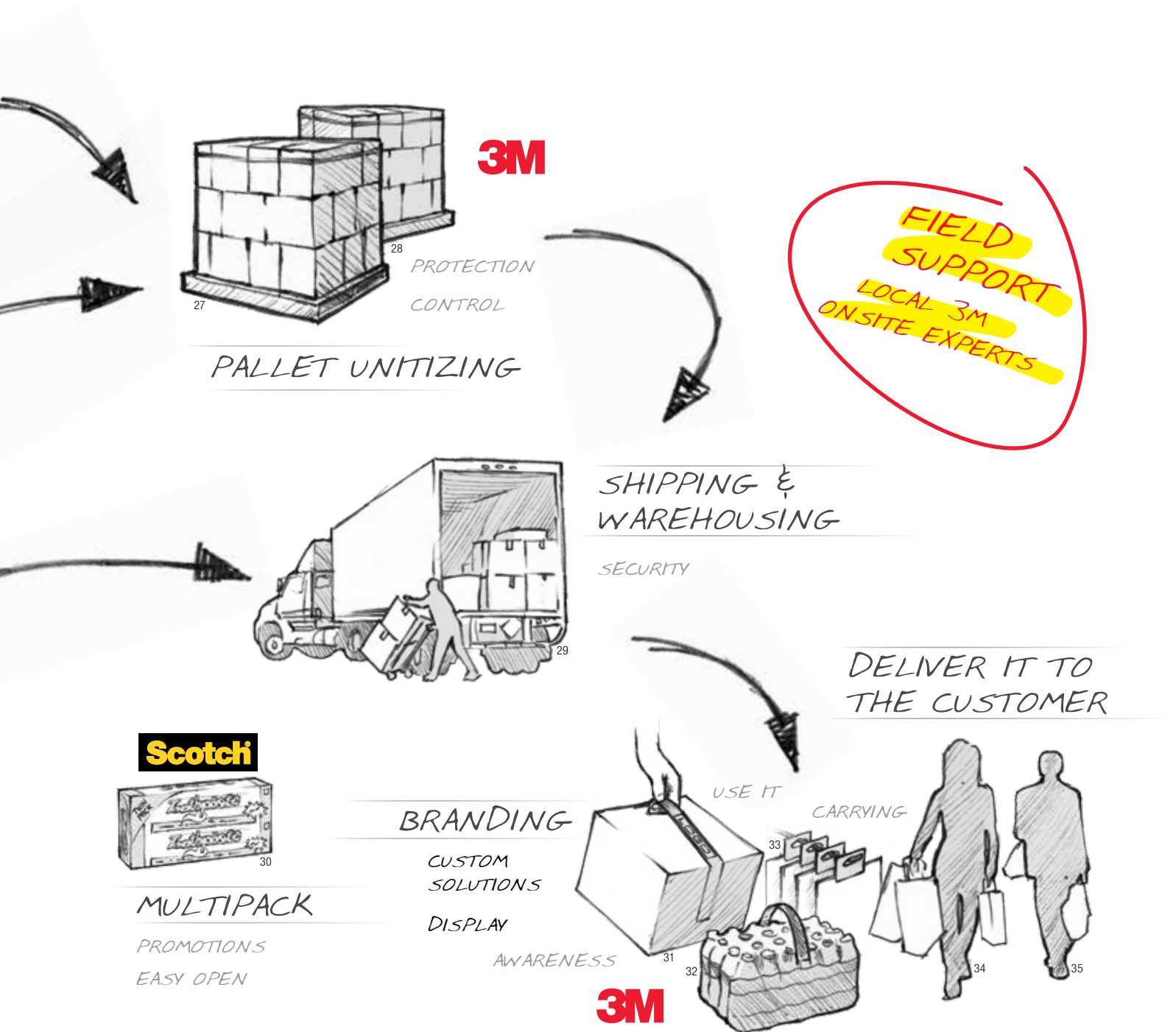

Packaging Equipment and Dispensers

CONSISTENT.
Reliable.
Tough.

Now, better than ever.

The end of your production line is no place for bottlenecks. That's why rock-solid dependability is the most important attribute of a case sealer. 3M-Matic™ Case Sealers have been setting the bar for consistent and reliable case sealing for more than 45 years. There's a 3M-Matic™ Case Sealer for virtually any packaging requirements in any size operation. You can count on it.

The seal is placed at the top center of each case.
Machine height is 670 to 700 mm.
Operator permission is required before for
overriding lock for or stress.
Pack must be at least 25 mm (1.0 in.)
long to start machine.

Connect to compressed
air source. See PG 562
for details.
Actual pressure regulator
to PG 562 max.

AIR PRESSURE
ON/OFF



3M-Matic™ Case Sealer

Things to Consider When Selecting a Case Sealer

1

**Do you pre-form your boxes?
What style box do you use?**

- RSC (regular slotted carton)
- FPF (five panel fold)
- Full overlap

3

What closure method do you use?

- RGT (reinforced gum tape)
- Pressure-sensitive box sealing tape
- Glue
- Staples

2

**How many boxes do you
seal per day?**

4

**Do you seal your boxes in uniform
or random production runs?**

3M-Matic™ Case Sealers Selection Overview



For Sealing Uniform Size Boxes

Manually Adjustable, Semi-Automatic

Affordable for Low Volume



40

a20

Up to 30 cs/min
Up to 65 lbs
Bottom belt drive



41

a80*

Up to 30 cs/min
Up to 65 lbs
Side belt drives

Engineered for High Volume



193

200a*

Up to 40 cs/min
Up to 85 lbs
Bottom belt drive



44

800ab

Narrow cases
Bottom only taping
Up to 40 cs/min
Up to 85 lbs
Side belt drives



194

800asb

Small cases
Up to 28 cs/min
Up to 85 lbs
Side belt drives



195

7000a Pro

Up to 40 cs/min
Up to 85 lbs
Top and bottom belt drives



191

8000a

Up to 40 cs/min
Up to 85 lbs
Side belt drives

Manually Adjustable, Semi-Automatic



36

800af

Up to 40 cs/min
Up to 85 lbs
Side belt drives

Case Former



48

700cf

3M-Matic™ Case Former and Sealer 700cf is an adjustable top and bottom belt drive case sealer with an integrated case former to form, pack and seal up to 15 cs/min.

*Available with 3 in. taping head



For Sealing Various Sized Boxes

Self Adjusting, Semi-Automatic



800r*
Up to 20 cs/min
Up to 85 lbs
Side belt drives



800rks†
Up to 10 cs/min
Up to 200 lbs
Top and bottom side belt drives



7000r Pro
Up to 24 cs/min
Up to 85 lbs
Top and bottom belt drives

Self Adjusting Fully-Automatic Flap Folding



800rf*
Up to 10 cs/min
Up to 65 lbs
Side belt drives

Non-RSC Box



S867
3M-Matic™ L-Clip Applicator S867 is a semi-automatic unit that applies 4.5 in. L-Clips of Scotch® Filament Tapes and Scotch® Box Sealing Tapes at up to 50 clips/min.

*Available with 3 in. taping head
†Comes standard with 3 in. taping head

Belt Drive Key

- 2 = Bottom belt drives
- 7 = Top and bottom belt drives
- 8 = Side belt drives

Box Type

- a = Adjustable, for batch runs
- r = Random, for mixed runs

Additional Capability

- b = Bottom only
- f = Flap folding
- ks = King size
- sb = Small box

3M-Matic™ Adjustable Case Sealers



Productivity with Quick Height and Width Adjustments

With quick manual adjustment, these rugged units reliably and accurately seal runs of the same size cartons for a variety of markets: food and beverage, medical devices, pharmaceutical, electronics, retail, manufacturing and distribution centers.



a20 40
3M-Matic™ Adjustable Case Sealer a20 is an adjustable bottom belt drive case sealer to dependably seal uniform cases at up to 30 per minute.



200a 193
3M-Matic™ Case Sealer 200a is an adjustable bottom belt drive case sealer to dependably seal uniform cases at up to 40 per minute.



700a-s 53
3M-Matic™ Adjustable Case Sealer 700a-s stainless steel has advanced features to seal uniform cases up to 30 per minute. Dual masts with dual lead screws for stability and uniform height adjustments. Adjustable top and bottom belt drive system for reliable conveyance of heavier or tall/light boxes. Compression rollers position each box for precise tape sealing. Stainless construction for corrosive environments.



7000a Pro 195
3M-Matic™ Adjustable Case Sealer 7000a Pro is an adjustable top and bottom belt drive to dependably seal uniform cases at up to 40 cases per minute.

Bottom Belt Drive Systems

Machine	Drive System	Box Size Capacity (inches)						Power Requirements		Operating Rate (cs/min)	Belt-Drive Speed ft/min (m/s)	Taping Head	Comments
		Minimum			Maximum			Electrical	Air				
		L	W	H	L	W	H						
a20	Bottom	6.0	6.5	4.25 [3.5]	N/L	21.5	21.5	115VAC 60Hz 2.8A 360W	No Air	Up to 30	78 (0,4)	2" 3M™ AccuGlide™ 2+	Entry Level
a20-s	Bottom	6.0	6.5	4.25 [3.5]	N/L	21.5	21.5	115VAC 60Hz 2.8A 360W	No Air	Up to 30	78 (0,4)	2" 3M™ AccuGlide™ 2+	Stainless Steel
200a	Bottom	6.0	6.5	4.5 [3.75]	N/L	21.5	24.5 [28.5]	115VAC 60Hz 1.9A 220W	No Air	Up to 40	100 (0,5)	2" 3M™ AccuGlide™ 3	Semi-Automatic Adjustable
200a3	Bottom	6.0	7.5	4.5 [3.75]	N/L	21.5	24.5 [28.5]	115VAC 60Hz 1.9A 220W	No Air	Up to 40	100 (0,5)	3" 3M™ AccuGlide™ 3	Semi-Automatic Adjustable

Standard size capabilities are listed above. If additional sizes can be met, they are indicated by [Taping Head] or [Machine Configuration]. Changing the taping head or machine configuration will allow for enhanced box height range indicated in the chart above. Please refer to the Instructions and Parts List or 3M representative for more detail.

Top and Bottom Belt Drive Systems

Machine	Drive System	Box Size Capacity (inches)						Power Requirements		Operating Rate (cs/min)	Belt-Drive Speed ft/min (m/s)	Taping Head	Comments
		Minimum			Maximum			Electrical	Air				
		L	W	H	L	W	H						
700a-s	Top and Bottom	6.0	6.0	4.75	N/L	21.5	24.5	115VAC 60Hz 3.8A 440W	No Air	Up to 30	78 (0,4)	2" 3M™ AccuGlide™ 2+ Stainless Steel	For Corrosive Environment
7000a Pro	Top and Bottom	6.0	6.5	2.0	N/L	26.5	28.0	115VAC 60Hz 3.8A 440W	No Air	Up to 40	100 (0,5)	2" 3M™ AccuGlide™ 3	Extended size capabilities are possible, please contact 3M
7000a3 Pro	Top and Bottom	6.0	6.5	2.0	N/L	26.5	28.0	115VAC 60Hz 3.8A 440W	No Air	Up to 40	100 (0,5)	3" 3M™ AccuGlide™ 3	

Standard size capabilities are listed above. If additional sizes can be met, they are indicated by [Taping Head] or [Machine Configuration]. Changing the taping head or machine configuration will allow for enhanced box height range indicated in the chart above. Please refer to the Instructions and Parts List or 3M representative for more detail.



3M-Matic™ Adjustable Case Sealers



a80
3M-Matic™ Adjustable Case Sealer a80 is an adjustable side belt drive case sealer that dependably seals uniform size cases.



8000a
3M-Matic™ Side Belt Adjustable Case Sealer 8000a is an adjustable side belt drive case sealer. Seals up to 40 cases per minute, using tape widths from 36mm to 48mm, and also 72mm tape.



800asb
3M-Matic™ Case Sealer 800asb is an adjustable side belt drive case sealer. Seals up to 28 cases per minute, using tape width of 36mm.



800af
3M-Matic™ Case Sealer 800af is an adjustable fully automatic case sealer.



3M-Matic™ T-table Attachment
3M-Matic™ T-table Attachment is a 6" x 44" t-table attachment for use with 3M-Matic™ Case Sealers a80 and a80-3.



800ab
3M-Matic™ Case Sealer 800ab is an adjustable side belt drive case sealer. Applies bottom seal only at rates up to 40 cases per minute, using tape widths from 36mm to 48mm, and also 72mm tape.

Side Belt Drive Systems

Machine	Drive System	Box Size Capacity (inches)						Power Requirements		Operating Rate (cs/min)	Belt-Drive Speed ft/min (m/s)	Taping Head	Comments
		Minimum			Maximum			Electrical	Air				
		L	W	H	L	W	H						
a80	Side	6.0	4.75	4.5	N/L	21.5	21.5	115VAC 60Hz 3.8A 440W	No Air	Up to 30	78 (0,4)	2" 3M™ AccuGlide™ 2+	Entry Level
a80-3	Side	6.0	5.75	4.5	N/L	21.5	21.5	115VAC 60Hz 3.8A 440W	No Air	Up to 30	78 (0,4)	3" 3M™ AccuGlide™ 2+	
a80b	Side	6.0	4.75	3.5	N/L	21.5	N/L	115VAC 60Hz 3.8A 440W	No Air	Up to 30	78 (0,4)	2" 3M™ AccuGlide™ 2+	Entry Level Bottom Taping Only
a80b-3	Side	6.0	5.75	3.5	N/L	21.5	N/L	115VAC 60Hz 3.8A 440W	No Air	Up to 30	78 (0,4)	3" 3M™ AccuGlide™ 2+	
8000a	Side	6.0	4.5	3.75	N/L	21.5	27.25	115VAC 60Hz 3.8A 440W	No Air	Up to 40	100 (0,5)	2" 3M™ AccuGlide™ 3	Extended size capabilities are possible, please contact 3M
8000a3	Side	6.0	5.5	4.25	N/L	21.5	28.25	115VAC 60Hz 3.8A 440W	No Air	Up to 40	100 (0,5)	3" 3M™ AccuGlide™ 3	
800asb	Side	6.0	3.9	2.75	N/L	21.5	22.25	115VAC 60Hz 3.8A 440W	No Air	Up to 28	57 (0,3)	1.5" 3M™ AccuGlide™ II	Small Box
800ab	Side	6.0	5.5	3.5	N/L	21.5	N/L	115VAC 60Hz 3.8A 440W	No Air	Up to 40	100 (0,5)	2" 3M™ AccuGlide™ 3	Bottom Taping Only
800ab3	Side	6.0	5.5	3.5	N/L	21.5	N/L	115VAC 60Hz 3.8A 440W	No Air	Up to 40	100 (0,5)	3" 3M™ AccuGlide™ 3	Bottom Taping Only
800af	Side	6.0	4.75	4.5 [3.75]	30	21.5	24.5 [28.5]	115VAC 60Hz 3.8A 440W	2.5 SCFM @ 85 PSIG	Up to 40	100 (0,5)	2" 3M™ AccuGlide™ 3	Flap-Folding
800af3	Side	6.0	5.75	4.5 [3.75]	30	21.5	24.5 [28.5]	115VAC 60Hz 3.8A 440W	2.5 SCFM @ 85 PSIG	Up to 40	100 (0,5)	3" 3M™ AccuGlide™ 3	
a80-t	Side	6.0	4.75	4.5	N/L	21.5	21.5	115VAC 60Hz 3.8A 440W	No Air	Up to 30	78 (0,4)	2" 3M™ AccuGlide™ 2+	Entry Level Pack Station

Standard size capabilities are listed above. If additional sizes can be met, they are indicated by [Taping Head] or [Machine Configuration]. Changing the taping head or machine configuration will allow for enhanced box height range indicated in the chart above. Please refer to the Instructions and Parts List or 3M representative for more detail.

3M-Matic™ Random Case Sealers



Productivity with Automatic Height and Width Adjustments

Adjusting automatically, these rugged units reliably and accurately seal runs of random size cartons for a variety of markets: food and beverage, medical devices, pharmaceuticals, electronics, retail, manufacturing and distribution centers. Patented 3M™ AccuGlide™ 2+ and 3 Taping Heads securely apply tape with low impact to protect even lightweight cases.



7000r Pro 192
3M-Matic™ Random Case Sealer 7000r Pro is a semi-automatic random case sealer that automatically adjusts for case height and width and is capable of sealing 24 cases per minute, using tape widths from 36mm to 48mm wide.



800r 49
3M-Matic™ Case Sealer 800r is a semi-automatic random case sealer automatically adjusts for case height and width. Top and bottom seal at rates up to 20 cases per minute, using tape widths from 36mm to 48mm wide.



800rks 50
3M-Matic™ Case Sealer 800rks is a random king size case sealer that automatically adjusts for case height and width and is capable of sealing up to 10 cases per minute, using tape widths from 48mm to 72mm wide.



800rf 51
3M-Matic™ Case Sealer 800rf Type 40800 is a fully automatic random size case sealer that automatically adjusts for various case sizes and folds the top minor and major flaps up to 10 cases per minute. Using tape widths from 36mm to 48mm tape widths.

Top and Bottom Belt Drive Systems

Machine	Drive System	Box Size Capacity (inches)						Power Requirements		Operating Rate (cs/min)	Belt-Drive Speed ft/min (m/s)	Taping Head	Comments
		Minimum			Maximum			Electrical	Air				
		L	W	H	L	W	H						
7000r Pro	Top and Bottom	6.0	6.5	2.25	N/L	26.5	26.0	115VAC 60Hz 3.8A 440W	3.75 SCFM @ 85 PSIG	Up to 24	100 (0,5)	2" 3M™ AccuGlide™ 3	Extended size capabilities are possible, please contact 3M
7000r3 Pro	Top and Bottom	6.0	6.5	2.25	N/L	26.5	26.0	115VAC 60Hz 3.8A 440W	3.75 SCFM @ 85 PSIG	Up to 24	100 (0,5)	3" 3M™ AccuGlide™ 3	

Standard size capabilities are listed above. If additional sizes can be met, they are indicated by [Taping Head] or [Machine Configuration]. Changing the taping head or machine configuration will allow for enhanced box height range indicated in the chart above. Please refer to the Instructions and Parts List or 3M representative for more detail.

Side Belt Drive Systems

Machine	Drive System	Box Size Capacity (inches)						Power Requirements		Operating Rate (cs/min)	Belt-Drive Speed ft/min (m/s)	Taping Head	Comments
		Minimum			Maximum			Electrical	Air				
		L	W	H	L	W	H						
800r	Side	8.0	4.0	5.0	N/L	20.0	21.25 [25.25]	115VAC 60Hz 3.8A 440W	3.75 SCFM @ 85 PSIG	Up to 20	100 (0,5)	2" 3M™ AccuGlide™ 3	Semi-Automatic Random
800r3	Side	8.0	4.0	5.0	N/L	20.0	21.25 [25.25]	115VAC 60Hz 3.8A 440W	3.75 SCFM @ 85 PSIG	Up to 20	100 (0,5)	3" 3M™ AccuGlide™ 3	
800rks	Side	15.0	6.0	12.0	N/L	30.0	50.0	208/240VAC 3Ph 60Hz 6.6A 1500W	6.25 SCFM @ 85 PSIG	Up to 10	78 (0,4)	3" 3M™ AccuGlide™ 2+	Random King Size
800rf	Side	8.0	5.5	6.0	24.0	20.0	20.0	208/240VAC 3Ph 60Hz 5.5A 1300W	7.0 SCFM @ 75 PSIG	Up to 10	100 (0,5)	2" 3M™ AccuGlide™ 3	Fully-Automatic
800rf3	Side	8.0	5.5	6.0	24.0	20.0	20.0	208/240VAC 3Ph 60Hz 5.5A 1300W	7.0 SCFM @ 75 PSIG	Up to 10	100 (0,5)	3" 3M™ AccuGlide™ 3	

Standard size capabilities are listed above. If additional sizes can be met, they are indicated by [Taping Head] or [Machine Configuration]. Changing the taping head or machine configuration will allow for enhanced box height range indicated in the chart above. Please refer to the Instructions and Parts List or 3M representative for more detail.

3M™ AccuGlide™ Taping Head Technology

3M Taping Heads for Easy and Accurate Case Sealing

3M™ AccuGlide™ Taping Heads are patented with a curvilinear design that applies tape securely with low impact that helps protect even lightweight cartons and contents. Since the combination of box sealing tape and taping head determines carton closure performance, 3M is continually improving both to meet your requirements for productivity and reliability.



3M™ AccuGlide™ 3
Raising the speed limit to 100 ft. per minute for easy, consistent and accurate case sealing.



3M™ AccuGlide™ 2+
Speeds up to 80 ft. per minute.



3M™ AccuGlide™ 2+ SSSL
Stainless steel resists corrosion. Speeds up to 80 ft. per minute.



3M™ AccuGlide™ NPH
Designed for case sealers with narrow taping head cavity. Applies tape at up to 100 ft. per minute.



3M™ AccuGlide™ LHB
A low height box taping head that exerts minimum force on case and utilizes shorter tape legs.



3M™ AccuGlide™ HST
Heads available to apply 48mm and 72mm wide tape at case speeds of up to 150 ft. per minute. Unique precision shaft and ball bushing slide ensure precise application.

Customized 3M-Matic™ Equipment

Built Around Your Product Needs

As a market leader in case sealing equipment, 3M realizes it's not one size fits all. We have a unique capability to take an existing 3M-Matic™ Case Sealer and customize it to securely seal your unique cartons. Some of our capabilities include width and height modifications, accommodating lighter or heavy weight boxes, and integrating unique tape set ups.



Side Taping



Gap Flap Taping



Wide Roll Taping

Non-RSC Closure Solutions

A Range of Solutions Can Increase Throughput While Decreasing Packaging Costs

- Solutions for start-ups
- Automation for large companies

3M-Matic™ L-Clip Applicator S867 and S867II

To save cost and time, apply pre-fed 4.5-inch L-Clips of Scotch® Filament or Reinforced Strapping Tapes at up to 50 clips per minute to five panel fold, full overlap, telescoping, tuck fold and other non-standard packages. Dual head applies two clips simultaneously as close as 8 inches apart.



3M-Matic™ Dual L-Clip Applicator S867II



3M-Matic™ L-Clip Applicator S867 with optional U-Clip adapter.

Great L-Clip Closure Solution for Non-RSC Box Styles

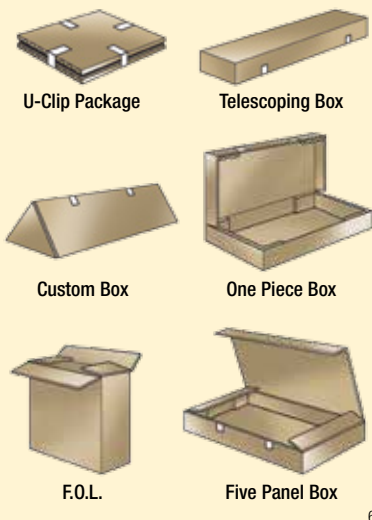

Table Top L-Clip Applicators

Features	Box Sealer S634
Tape Type(s)	Filament Tape Light Duty Packaging Tape
Can L-Clip These Package Types	Corrugate
Applied Tape Length	4 in.
Tape Width Options	9mm to 18mm
Cutting Method	Serrated blade cuts tape as box passes L-Clip application mechanism



Scotch® Filament Tape Box Sealer S634

3M-Matic™ Case Sealers Replacement Parts and Accessories

Genuine 3M Parts to Maintain Optimal Performance of 3M-Matic™ Case Sealers

Engineered for rugged duty with steel construction and epoxy coated surfaces, 3M-Matic™ Case Sealers may have parts that wear and need occasional replacement. 3M maintains stock of a full range of replacement parts from typical wear parts such as blades, belts, and springs to safety labels to bushings and cylinders. With over 5,000 stocked SKUs, replacement parts are available for prompt delivery to your location whether you are doing preventive maintenance or rebuilding a 3M-Matic™ Case Sealer after years of service.

Regular preventive maintenance of your equipment and quality parts are keys to performance of both newer case sealers or models that have been running for 30 years.



71



Application Monitor

With top and bottom sensors, the case sealer mounted programmable logic controller alerts the operator when tape is not applied to the box or not cut, or when tape supply is low on the roll.



Low Tape Indicator Light Kit

An option for 3M-Matic™ Case Sealers. Indicates when tape is getting low.



3-Flap Folder

For increased productivity, easily attached flap folder assists operator in folding the minor (front) and two major (side) flaps of RSCs before taping.



Infeed/Exit Conveyor

Ball bearing steel rollers in a steel frame bolts to the 3M-Matic™ Case Sealer to provide a smooth transition in existing conveyor lines. Provides pack area surface at infeed. Available also in stainless steel.



Box Hold Down Attachment

Holds RSCs on the optional infeed conveyor to free the operator's hands for case filling.



Locking/Swivel Casters

When packaging operations need to be reconfigured or moved, 3M-Matic™ Case Sealers roll to the job on these heavy duty casters. Toe-operated lever locks case sealer in place.

Scotch® Tape Dispensers

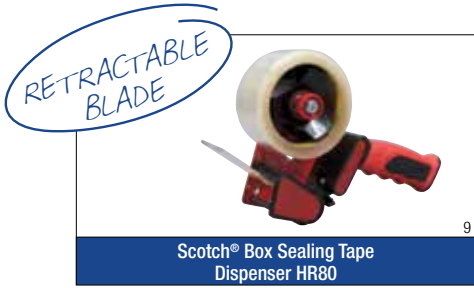

Scotch® Box Sealing Tape Dispenser HR80
 Portable, lightweight, easy to operate, hand-held dispenser with a retractable blade.



Scotch® Low Noise Box Sealing Tape Dispenser H150
 A hand-held, roll-on, pistol-grip dispenser designed to reduce the noise of tape unwind.

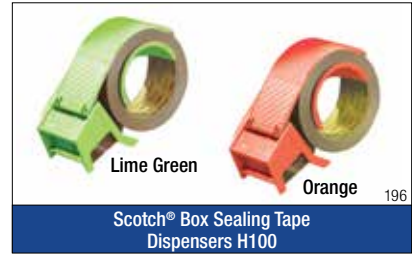

Scotch® Box Sealing Tape Dispensers H100
 A hand-held, roll-on, pistol-grip dispenser.

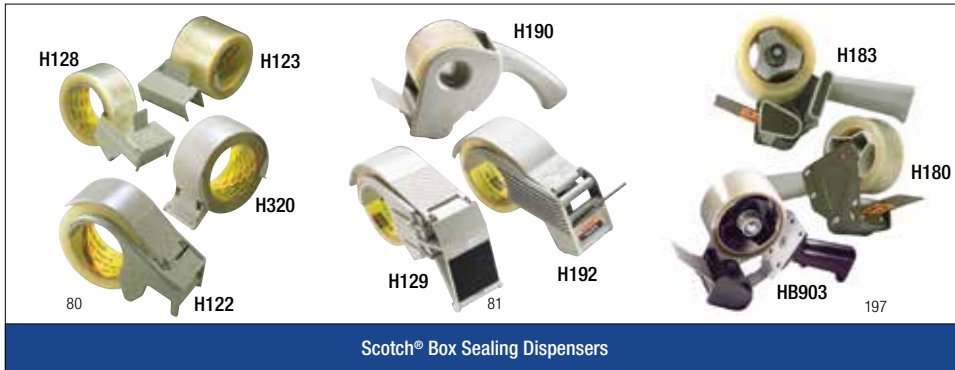

Hand-held dispensers for use with specially formulated Scotch® Box Sealing Tapes.



Applies tape in an adhesive-to-adhesive flag seal.

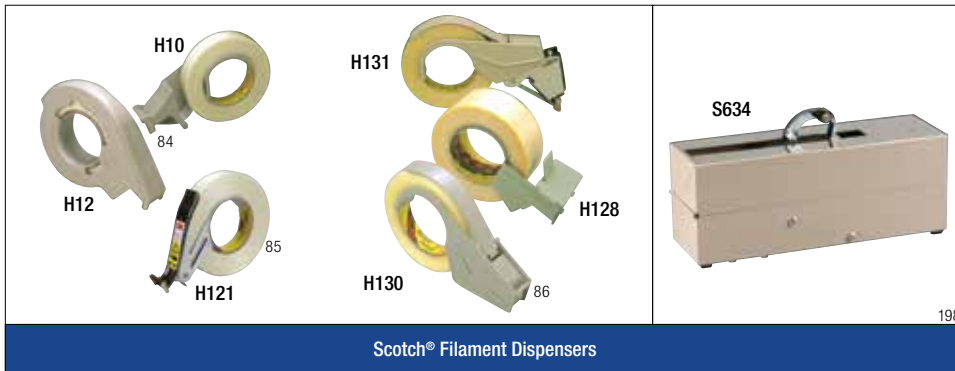

Hand-held dispensers for use with Scotch® High Strength Filament Tapes.

Semi-automatic dispensers for use with Scotch® High Strength Filament Tapes.

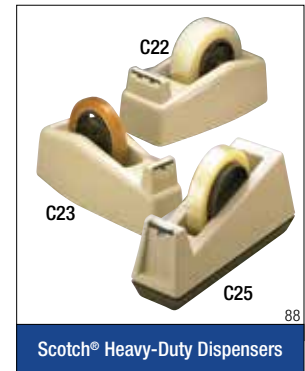

Manual heavy-duty dispensers for use with 3M™ Narrow Width Film Tapes.



Dispenser has a heated water reservoir that speeds tape activation. Dispenses a pre-set length of water-activated tape at the push of a button.

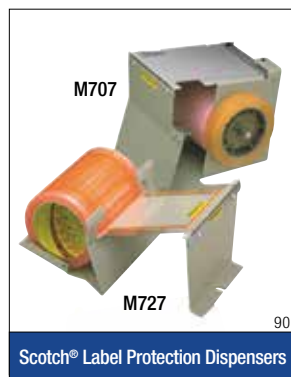

Tabletop and portable dispensers designed specifically for 3M™ Label Protection and Pouch Tapes.

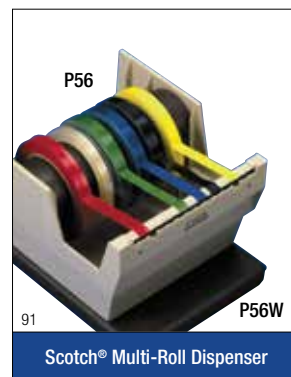

Dispenser for pull and tear of up to 6 inches total width of tapes. P56W offers weighted base.



Dispensers that deliver a uniform length of 3M™ Narrow Width Tape and Scotch® Filament Tapes every time quickly and easily.

Scotch® Tape Dispensers

Easy Dispensing for Manufacturing, Office, Commercial and Retail Jobs

All Scotch® Manual Dispensers for box sealing tapes, filament tapes, film tapes, label protection tapes and pouch tapes are application-designed to meet the needs of the customer. Select from a variety of hand-held and heavy duty pull-and-tear table top dispensers.

Product	Product Description	Max Tape Width
Hand-Held Box Sealing Tape Dispensers		
H100	Durable, lightweight plastic tape dispenser	50.8mm
H122	Durable plastic dispenser with built-in brake for precise seals	48mm
H123	Lightweight, compact metal tape dispenser	72mm
H128	Heavy-duty durable metal tape dispenser	48mm
H129	Quick and easy one hand method to apply, cut, and buff the tape closures	48mm
H150	Tape dispenser designed to reduce the noise of tape unwind during application	48mm
H153	Tape dispenser designed to reduce the noise of tape unwind during application	72mm
H180	Portable and easy to operate pistol grip dispenser	48mm
H183	Portable and easy to operate pistol grip dispenser	72mm
H190	Pistol grip dispenser features pull apart design	48mm
H192	Ergonomical tape dispenser with hand brake	48mm
H320	Ultra-light, economical, plastic tape dispenser	48mm
HB902	Economical, compact, and lightweight tape dispenser	48mm
HB903	Economical pistol grip tape dispenser	48mm
HR80	Portable, lightweight, easy to operate, dispenser with a retractable blade	48mm
HR83	Portable, lightweight, easy to operate, dispenser with a retractable blade	72mm
HR933	Tape dispenser with a retractable blade	72mm
Hand-Held Filament Tape Dispensers		
H10	Durable, lightweight plastic tape dispenser	24mm
H12	Portable, plastic dispenser features a hand brake to add tension to the tape roll	24mm
H121	Durable, metal dispenser allows operator to add tension for a tighter tape application	24mm
H128	Heavy-duty, metal dispenser commonly used to dispense tapes 8959 and 890	48mm
H130	Portable, plastic dispenser features a hand brake to add tension to the tape roll	18mm
H131	Quick and easy one hand method to apply, cut, and buff the tape closures	18mm
H133	Quick and easy one hand method to apply, cut, and buff the tape closures	18mm
HB901	Economical and portable tape dispenser	24mm
Table Top Dispensers		
C22	Weighted dispenser for easy pull and cut tape dispensing	2 in.
C23	Weighted dispenser for easy pull and cut tape dispensing	1 in.
C25	Weighted dispenser for easy pull and cut tape dispensing	1 in.
HB900	Weighted, slip-proof base for quick and easy one-handed operation	1 in.
M82	Definite length dispenser handles multiple rolls of tape commonly dispensed with filament and light duty tapes	96mm
M96	Definite length dispenser — dispenses tape in lengths of 3/4 in. to 5 in. per stroke	1 in.
M900	Durable, metal construction dispenses a uniform length of packaging tape from 1-1/2 in. to 16 in.	3 in.
M920	Definite length dispenser — dispenses tape in lengths of 1/2 in. to 4 in. per stroke	1 in.
P52	Mainline tabletop manual pull and cut dispenser with multiple roll capacity	2 in.
P52W	Mainline tabletop manual pull and cut dispenser with multiple roll capacity (comes with weighted base)	2 in.
P56	Mainline tabletop manual pull and cut dispenser with multiple roll capacity	6 in.
P56W	Mainline tabletop manual pull and cut dispenser with multiple roll capacity (comes with weighted base)	6 in.
P448	Metal dispenser that handles multiple rolls for easy dispensing	8 in.
S634	Semi-automatically applies L-Clip of tape to a box using filament or light duty tapes	18mm
W100	Manually dispenses pre-set length of water-activated tapes	3 in.
W200	Electronic dispenser — dispenses a pre-set length of water-activated tape at the push of a button	3 in.
Specialty Tape Dispensers		
M707	Heavy duty metal dispenser with auxiliary holder and cutter for 3/4-inch rolls of tape — commonly used with 821 and 823 tapes	4 in.
M727	Metal construction provides easy dispensing of pouch tapes 824, 827 and 829	5 in.
M797	Metal construction provides easy dispensing of pouch tape 827	6 in.
P400	Bag sealer — applies tape in an adhesive-to-adhesive — flag seal (includes bag trimmer)	3/4 in.
P410	Bag sealer — applies tape in an adhesive-to-adhesive flag seal	1/2 in.

3M Systems Tape Agreement

Buy a New 3M-Matic™ Case Sealer and Scotch® Box Sealing Tape, Get a Cash Rebate or Accessories at No Additional Charge

The 3M Systems Tape Agreement allows you to:

- Save on the overall cost of your case sealing equipment
- Accelerate your packaging equipment Return on Investment
- Receive valuable parts and accessories at no charge
- Increase productivity and uptime
- Choose options that best fit your needs



The More Tape You Purchase,

The Greater Your Rebate and Savings!

Earn Cash Rebates*

Earn cash rebates when you purchase a new 3M-Matic™ Case Sealer or Combi Packaging Systems equipment and purchase qualifying amounts of Scotch® Box Sealing Tape in accordance with the terms of the program.



Add Credits Towards a New Case Sealer**

- Spare parts kits or parts vouchers
 - Earn free spare parts for your 3M-Matic™ Case Sealer when you purchase qualifying amounts of Scotch® Box Sealing Tape
- 3M™ AccuGlide™ Taping Heads
 - Earn free 3M™ AccuGlide™ Taping Heads for your 3M-Matic™ Case Sealer when you purchase qualifying amounts of Scotch® Box Sealing Tape
- 3M™ Scotch™ Manual Tape Dispenser
 - Earn a free dispenser when you purchase qualifying amounts of Scotch® Box Sealing Tape



Sign a second Systems Tape Agreement, get another taping accessory at no additional charge†

3M tape dispensers available with qualifying purchases.

*Rebate check is paid directly from 3M to customer after completing purchase of 3M-Matic™ Case Sealing Equipment and qualifying tape products. Dollar amount of rebate is determined by equipment purchase price, plus tape model and pallet quantity ordered.

**3M™ AccuGlide™ Taping Heads, Spare Parts Kits and Hand Dispensers are shipped up front to customer upon signing new tape purchase agreement. Parts Vouchers can be used as needed during the agreement term.

†Purchase requirements for initial Systems Tape Agreement must be satisfied in order to enter into a second agreement.

Box Sealing Tapes



Scotch® and Tartan™ Box Sealing Tapes

Technology That Really Delivers

The full job of a package is containment, protection and communication.

Delivering quality with tapes that keep production lines moving with less interruption and ensure packages are sealed on arrival.

- 3M tapes can typically wrap the world 3.5 times before a defect is found
- Cost savings with fewer rejected shipments

Delivering service and support to help you select the right 3M product for your application.

- On-site consultation with experienced 3M engineers and sales specialists

Delivering sustainability by caring for the environment now and for the future.

- The manufacturing process of our 3M™ Scotch® Box Sealing Tape is now virtually free of organic solvents. This equates to total avoided emissions of about 100MT CO2-e per year.
- Our Scotch® Recycled Corrugate Tape 3073 is made with an adhesive that contains over 10% bio-based content. All recycled corrugate tapes use recycled materials in the core to help with your sustainability goals.

Delivering more. In addition to box sealing tapes and equipment, 3M is your resource for bundling, reinforcing, labeling and other innovative packaging solutions.

Technology That Solves Common Problems



Easy unwind and high initial adhesion of Scotch® Box Sealing Tapes reduce tabbing downtime and rework.



Initial adhesion and subsequent holding power of Scotch® Box Sealing Tapes resist popping for secure sealing throughout a supply chain.



Scotch® Box Sealing Tapes close securely without the holes, waste, appearance, sharp points and disposal of staples.



Scotch® Box Sealing Tapes resist moisture encountered in storage and shipping through the supply chain.

Tape Backing and Adhesive Selection Guide

Step 1. Select Tape Backing

Scotch® and Tartan™ Box Sealing Tapes offer backing choices for specific performance properties:

Polyester

- Strongest backing
- Excellent abrasion resistance
- Moisture and chemical resistance
- Highest temperature resistance
- Transparency

Polypropylene

- Strong backing
- Good abrasion resistance
- Good conformability
- Most economical
- Transparency

Step 2. Select Tape Adhesive

With the Scotch® and Tartan™ Box Sealing Tapes you have two choices of pressure sensitive adhesive, each with a different combination of properties. Both seal cartons reliably without the mess, dwell time and equipment maintenance of hot melt adhesive.

Synthetic Rubber

- Excellent holding power
- Good initial adhesion above 40°F
- Meets ASTM D-5486 government specification

Acrylic

- Excellent initial adhesion over a broad temperature range
- Extremely long performance life
- UV and chemical resistance

Box Sealing Tape Selector

Additional packaging and shipping factors should be considered when selecting a box sealing tape. To determine a product for testing use this selector.

Circle the Point Value That Best Describes Your Operations			Choose an Effective Closure...Choose 3M				
	Point Value	POINTS					
1. How much does the filled box weigh?							
a. 10 pounds	10						
b. 20 pounds	20						
c. 30 pounds	25						
d. 40 pounds	30						
e. 50 pounds	35						
f. 70 pounds	45						
g. 80 pounds	50						
h. 100 pounds	60						
2. What is the carton burst/ECT test?							
a. 150 SW/26	5						
b. 175 SW/29	10						
c. 200 SW/32	15						
d. 250 SW/40	20						
e. 275 SW/44	25						
f. 350 SW/55	30						
g. 200 DW/42	35						
h. 275 DW/48	40						
i. 350 DW/51	45						
3. What is the value of contents?							
a. <100	10						
b. 100–1000	25						
c. >1000	40						
4. What is the method of shipment?							
a. Palletized and unitized	5						
b. Palletized but not unitized	15						
c. Single	30						
5. Type of carrier							
a. Company truck	5						
b. Commercial transport/LTL	15						
c. UPS/USPS/FEDEX	30						
TOTAL POINTS							
			205				
			195				72mm
			180				
			165			72mm	
			150				48mm
			135				
			120		72mm	48mm	
			105				
			90	72mm	48mm	42mm	
			75				
			60	48mm	42mm		36mm
			45				
			35	42mm	36mm	36mm	
			35	36mm			
			TOTAL POINTS	Scotch® Box Sealing Tape Recommended for Testing			
				#3071	#3072	#3072	#3073
				#371	#372	#373	#375
				#311	#313		#355

The suggestion provided by this method must be confirmed by testing. These suggestions are based on experience, but there are factors which could alter the overall performance. For example:

- Cartons with center seam gap greater than 3/4" or over packed/ under packed cartons should be tested with 3" (72mm) wide tape
- Hard-to-stick surfaces and Recycled Corrugate Boxes, test Scotch® Recycled Corrugate Tape 3071, 3072 and 3073
- Box sealing tapes are available custom printed and with standard security messages
- Applications when tape is applied under 40°F, test Scotch® Box Sealing Tape 311, 313 and 3073
- If your package is unusual in size, shape, or load, try the 3M Technical Service Request (TSR) Program. Using the 3M TSR Program, a 3M representative will work with you on initial testing of a Scotch® Box Sealing Tape. One or two best options will be identified then a sample of your substrate is brought to the 3M Laboratories and tested for stress or other factors the product will encounter. The 3M test results will help you select the best box sealing tape for your manufacturing process and customer needs.

Scotch® and Tartan™ Box Sealing Tapes

Dependability for Food and Beverage, Electronics, e-Fulfillment, Pharmaceuticals and More

With choices of polyester or polypropylene backings and synthetic rubber or acrylic adhesives, you have dependability for a wide variety of box types, sizes, contents, handling situations and storage conditions.

- Reliability even with the stresses of over packed or under packed boxes
- Quick, easy application by hand, manual dispensers or 3M-Matic™ Case Sealers
- Choice of lengths, widths and colors to meet specific needs

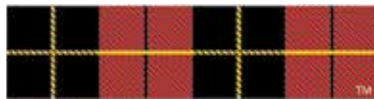

Scotch® Box Sealing Tapes with polyester backing and synthetic rubber adhesive resist the moisture in storage and shipping.

Consistent quality of Scotch® Box Sealing Tapes means fewer interruptions on your packaging line.

It's not sealed until it's Scotch® Sealed.

Product	Tape Structure (Backing/Adhesive)	Adhesion to Steel oz./in. (N/100 mm)	Tensile Strength lbs./in. (N/100 mm)	Elongation at Break (%)	Backing Thickness mils (mm)	Total Thickness mils (mm)	Available Colors/Comments
ASTM Test Method		D-3330	D-3759	D-3759	D-3652	D-3652	
Scotch® Box Sealing Tapes							
311	Polypropylene/Acrylic	22 (24)	25 (438)	125	1.1 (.028)	2.05 (.052)	Yellow, Clear, Tan, Red, Blue, White
313		32 (35)	35 (613)	125	1.6 (.041)	2.55 (.065)	Clear
315		38 (41.5)	23 (402)	200	2.3 (.058)	3.5 (.089)	
351	Polyester/Synthetic Rubber	78 (85)	67 (1174)	130	2.0 (.051)	3.43 (.089)	Clear, Tan or Custom Printed
353		45 (49)	25 (437)	110	1.0 (.025)	1.9 (.048)	Clear, Tan
355		78 (85)	67 (1174)	130	2.0 (.051)	3.43 (.089)	Clear, Tan or Custom Printed
371	Polypropylene/Synthetic Rubber	40 (44)	22 (385)	160	1.2 (.030)	1.8 (.046)	Clear, Tan, Blue, Green, Orange, Red, White, Yellow or Custom Printed
372		45 (49)	26 (455)	160	1.4 (.035)	2.2 (.056)	Clear, Tan or Custom Printed
373		50 (55)	30 (525)	160	1.6 (.041)	2.5 (.064)	Clear, Tan, Blue, Green, Orange, Red, White, Yellow or Custom Printed
375		55 (60)	35 (613)	160	2.0 (.051)	3.1 (.079)	Clear, Tan or Custom Printed
Tartan™ Box Sealing Tapes							
302	Polypropylene/Acrylic	18 (20)	23 (402)	116	1.0 (.025)	1.6 (.040)	Clear, Tan
305		18 (20)	21 (368)	116	1.0 (.025)	1.8 (.046)	
369	Polypropylene/Synthetic Rubber	30 (32)	19 (333)	160	1.0 (.025)	1.6 (.041)	

Strength that Sticks to Recycled Corrugate Cartons

With environmental standards changing rapidly and companies constantly seeking new ways to reduce costs and improve their environmental footprint, packaging materials are in a constant state of flux. Scotch® Recycled Corrugate Tapes are designed to help you stay on top of the changes.

- They're tackier than conventional box sealing tapes
- Made with a proprietary adhesive designed specifically for recycled corrugate cartons

Product	Tape Structure (Backing/Adhesive)	Adhesion to Steel oz./in. (N/100 mm)	Tensile Strength lbs./in. (N/100 mm)	Elongation at Break (%)	Backing Thickness mils (mm)	Total Thickness mils (mm)	Available Colors/Comments
ASTM Test Method		D-3330	D-3759	D-3759	D-3652	D-3652	
Scotch® Recycled Corrugate Tapes							
3071	Polypropylene/Synthetic Rubber	45 (49)	22 (385)	160	1.2 (.030)	2.1 (.053)	For use on recycled corrugate cartons, Custom Printed
311+	Polypropylene/Acrylic	38 (42)	25 (438)	125	1.1 (.028)	2.05 (.052)	Clear
3072	Polypropylene/Synthetic Rubber	65 (71)	22 (385)	160	1.2 (.030)	2.3 (.058)	For use on recycled corrugate cartons, Custom Printed
3073		46 (50)	30 (525)	160	1.6 (.041)	2.6 (.066)	For use on recycled corrugate cartons, Custom Printed, 10% bio-based content

Note: This technical information and data should be considered representative or typical only and should not be used for specification purposes.

Scotch® Specialty Box Sealing Tapes

Dependability for Cold Storage, Gapped Flap Cartons and More

Starting with the same dependability and durability of Scotch® Box Sealing Tapes, specialty tapes add specialized form and/or functional properties for specific applications across all markets.



For box packing, sealing and storage below 40°F, Scotch® Box Sealing Tapes 3073 and 3723 seal with a rubber adhesive modified for reliability in the cold.



Scotch® Box Sealing Tape 3779 alerts receivers to unauthorized opening with a red “Check Seal Before Accepting.”

Product	Tape Structure (Backing/Adhesive)	Adhesion to Steel oz./in. (N/100 mm)	Tensile Strength lbs./in. (N/100 mm)	Elongation at Break (%)	Backing Thickness mils (mm)	Total Thickness mils (mm)	Available Colors/Comments
ASTM Test Method		D-3330	D-3759	D-3759	D-3652	D-3652	
Cold Temperature Tapes							
311+	Polypropylene/Acrylic	38 (42)	25 (438)	125	1.1 (.028)	2.05 (.052)	Clear
3723	Polypropylene/Modified Synthetic Rubber	45 (49)	30 (525)	160	1.6 (.041)	3.0 (.076)	Clear
Custom Printed Tapes							
355CP	Polyester/Synthetic Rubber	78 (85)	67 (1174)	130	2.0 (.051)	3.42 (.089)	Clear, Tan
371CP	Polypropylene/Synthetic Rubber	40 (44)	22 (385)	160	1.2 (.030)	1.8 (.046)	Clear, Tan, Blue, Green, Orange, Red, White, Yellow
372CP		45 (49)	26 (455)	160	1.4 (.035)	2.2 (.056)	Clear, Tan
373CP		50 (55)	30 (525)	160	1.6 (.041)	2.5 (.064)	Clear, Tan, Blue, Green, Orange, Red, White, Yellow
375CP		55 (60)	35 (613)	160	2.0 (.051)	3.1 (.079)	Clear, Tan
3071CP		45 (49)	22 (385)	160	1.2 (.030)	2.1 (.053)	For use on recycled corrugate cartons
3073CP		46 (50)	30 (525)	160	1.6 (.041)	2.6 (.066)	10% bio-based and for use on recycled corrugate cartons
Security Tapes							
3199	Polypropylene/Acrylic	22 (24)	25 (438)	125	1.1 (.028)	2.05 (.052)	Clear with Red Type: CHECK SEAL BEFORE ACCEPTING
3732	Polypropylene/Synthetic Rubber	50 (55)	30 (525)	160	1.6 (.041)	2.5 (.064)	Tan with Red Type: IF SEAL IS BROKEN CHECK CONTENTS BEFORE ACCEPTING
3771		40 (44)	22 (385)	160	1.2 (.030)	1.8 (.046)	White with Red Type: IF SEAL IS BROKEN CHECK CONTENTS BEFORE ACCEPTING
3772		40 (44)	22 (385)	160	1.2 (.030)	1.8 (.046)	White with Red Type: FRAGILE HANDLE WITH CARE
3775		40 (44)	22 (385)	160	1.2 (.030)	1.8 (.046)	White with Red Type: MIXED MERCHANDISE ENCLOSED
3779		40 (44)	22 (385)	160	1.2 (.030)	1.8 (.046)	Clear with Red Type: CHECK SEAL BEFORE ACCEPTING

Product	Tape Structure (Backing/Adhesive)	Basis Weight	Caliper (mils)	Tensile Strength (lbs. / in.)	Tear Strength (grams)	Available Colors/Comments
ASTM Test Method		D-646	D-645	D-5803	D-1922	
3M™ Water Activated Tapes						
6141	Paper backing/gummed modified cornstarch based adhesive	35	3.5	30	72	Kraft (Tan) or Custom Printed
6142		60	5.5	44	125	
6143		90	7.5	58	200	
6144	Paper backing with filament reinforcement/gummed modified cornstarch based adhesive	23/23	4.9	45–50	N/A	Kraft (Tan) or Custom Printed
6145		23/23 (Kraft) 30/23 (White)	5.0 (Kraft) 7.3 (White)	52–57	N/A	Kraft (Tan), White or Custom Printed
6146		30/23	6.5	60–65	N/A	Kraft (Tan) or Custom Printed
6147		23/23 (Kraft)	8.5	60–65	N/A	Kraft (Tan) or Custom Printed

Note: This technical information and data should be considered representative or typical only and should not be used for specification purposes.

Light Duty Packaging Tapes

Versatility with Choices of Film Backings and Adhesives for Application Success

Typical Light Duty Applications

- Garment bundling
- Cookie tin seam sealing
- Plastic bag closure
- Attaching extended application tube to aerosol can
- Party tray closure
- Wrapped candy box closure
- Wrapper closure
- Document envelope closure
- Inner pack box closure

Variety of Surfaces

- Fabrics
- Molded plastics
- Metals
- Clay-coated paperboard
- Corrugated
- Vinyl and films



Hold plastic tray lid with Scotch® Transparent Film Tape 605.

104

Tapes for Apparel Tabbing and Holding

- **Scotch® Transparent Film Tape 600:** UPVC backing with very high strength acrylic adhesive
- **Scotch® Transparent Film Tape 640:** UPVC backing with clean removal acrylic adhesive for a wider variety of fabric finishes and treatments; formulated for tabbing shirts and underwear

Tapes for Other Light Duty Applications

- **Scotch® Transparent Film Tape 605:** Polypropylene backing with very aggressive acrylic adhesive for cold temperature applications
- **Scotch® Colored Film Tape 690:** UPVC backing with natural rubber adhesive for sealing and color coding



Scotch® Transparent Film Tape 640

105



Scotch® Colored Film Tape 690

91



Scotch® Colored Film Tape 690

107

Light Duty Packaging Tapes

Product	Color	Backing Material	Backing Thickness mils (mm)	Total Thickness mils (mm)	Tensile Strength lb/in (N/100 mm)	Adhesive Type	Adhesion to Steel oz/in (N/100 mm)	Elongation (%)	Typical Use	Comments
600	Clear	UPVC	1.5 (0.038)	2.3 (0.058)	28 (490)	Acrylic	40 (44)	45	L-Clip closure, attaching, tabbing and holding	Excellent handling, high clarity and long aging
605	Clear	Polypropylene	1.6 (0.041)	2.5 (0.064)	22 (385)	Acrylic	27 (30)	57	Cold temperature packaging	Cold temperature applications; Complies to FDA Regulations for indirect food contact
610	Clear	Cellophane	1.4 (0.036)	2.3 (0.058)	23 (402)	Natural Rubber	35 (38)	15	Splicing	High heat applications up to 300°F
640	Clear	UPVC	1.2 (0.030)	1.9 (0.048)	32 (560)	Acrylic	28 (30)	65	Tabbing and holding of apparel	Clean removal from wide variety of fabrics and substrates
660	Red	Cellophane	1.4 (0.036)	2.5 (0.064)	20 (350)	Natural Rubber	50 (55)	10	Splicing and easy detection	High heat applications up to 300°F; High adhesion
681	Clear	UPVC	1.5 (0.038)	2.4 (0.061)	25 (438)	Natural Rubber	30 (33)	35	Sealing	Resists moisture and chemicals; Heat shrinkable; Complies to FDA Regulations for indirect food contact
690	Black, Blue, Green, Red, Yellow, White	UPVC	1.5 (0.038)	2.3 (0.058)	35 (613)	Natural Rubber	30 (33)	45	Color coding	Resists moisture and chemicals; Heat shrinkable
856	Transparent	Polyester	1.0 (0.025)	2.0 (0.051)	25 (438)	Acrylic	20 (22)	90	Tough backing for good tear resistance	Tough backing for good tear resistance
5910	Clear	Polypropylene	1.2 (0.030)	2.0 (0.051)	18 (315)	Acrylic	16 (17)	90	Utility grade for light duty packaging applications	Conforms easily
Fingerprint Lifting Tape										
8004	Clear	Polypropylene	1.4 (0.036)	2.0 (0.051)	18 (315)	Acrylic	16 (17)	90	Ultra clear tape; Handles easily	Lift and preserve physical evidence such as fingerprints

Technologies Matched to the Applications

Choice of Backings

- **UPVC** for transparency plus moisture, chemical and UV resistance; non-staining and heat-shrinkable
- **Polypropylene** for transparency plus conformability and flexibility
- **Cellophane** for heat resistance
- **Polyester** for strength and abrasion resistance

Choice of Adhesives

- **Acrylic** for long aging and UV resistance
- **Rubber** for high initial bond strength and adhesion to wide variety of materials including hard-to-bond plastics

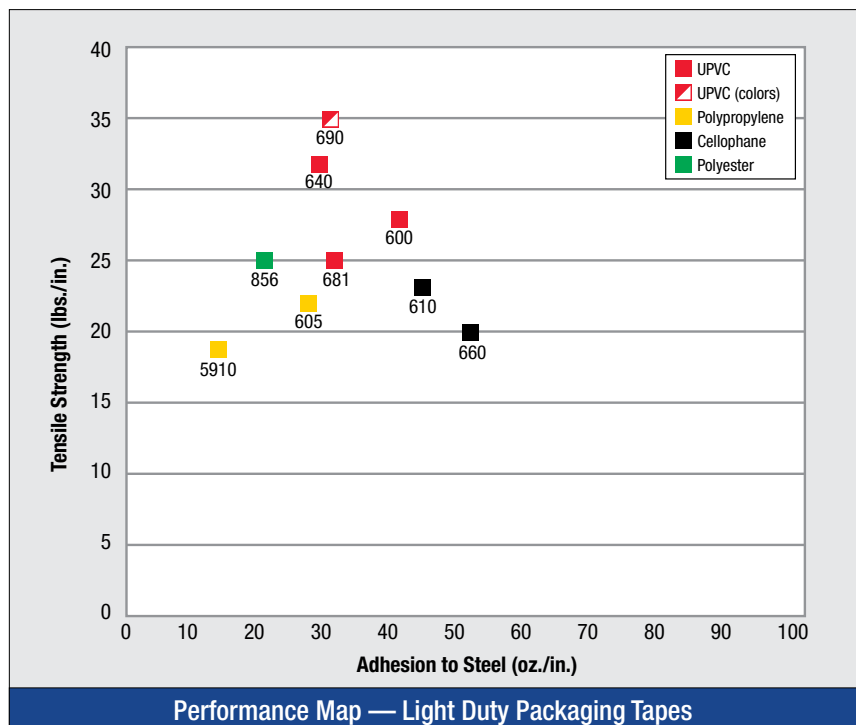

200

Note: This technical information and data should be considered representative or typical only and should not be used for specification purposes.

High Strength Tapes

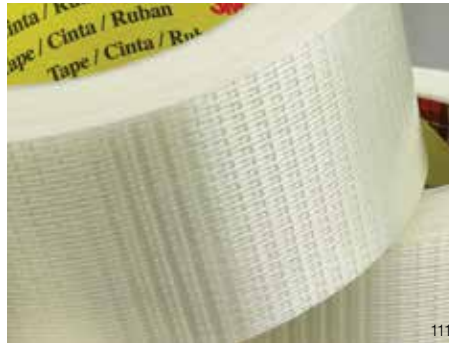

High Strength Tapes

For Packaging and Non-Packaging Applications

When you need a tape as strong as your reputation, you can count on 3M's consistently reliable, market-leading high strength tapes that are engineered to meet virtually any strapping, bundling or reinforcing challenge.

SELECTION: Our range of high strength tape constructions can help balance your product performance and budget needs.

SAVE TIME AND MONEY: Let 3M's application and technical experts, backed by a robust lab testing capability, help match the right tape to your performance requirements.

PEACE OF MIND: Scotch® and 3M brands are among the most innovative and trusted in the world. Our world-class tape manufacturing facilities churn out consistent and reliable products, roll after roll.

Filament Reinforced Tape

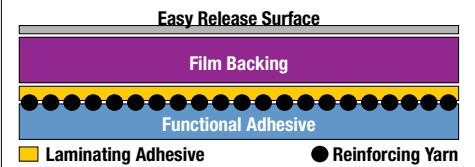

Reinforced Strapping Tape



Tensilized Polypropylene Tape

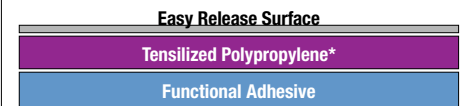

*A pre-stretched film to orient the backing for strength

Streamlined Selection for Application Success

HOLDING
Up to **120 lbs./in.**



Pallet Unitizing

BUNDLING
Up to **270 lbs./in.**



Carpet Bundling

CLOSING
Up to **600 lbs./in.**



L- and U-Clip Closures



Bundling for Shipping and Handling



PVC Pipe Bundling



Stabilizing Loose Parts



Bulk Bin or Skid Box Banding



Rebar Bundling



Metal Coil Tabbing

Product	Description	Tensile Strength*
8934	Glass yarn reinforced	100 lbs./in.
860	Tensilized polypropylene	110 lbs./in.
862	Reinforced strapping tape for strength AND high tape clarity	120 lbs./in.

Product	Description	Tensile Strength*
897	Glass yarn reinforced	170 lbs./in.
893	Glass yarn reinforced	300 lbs./in.
880	Polyester yarn reinforced	270 lbs./in.

Product	Description	Tensile Strength*
898	Glass yarn reinforced, first choice for L- or U-Clip closure of non-RSC boxes	380 lbs./in.
890MSR	Glass yarn reinforced, modified synthetic rubber adhesive for oily surfaces	600 lbs./in.
8899HP	Tensilized polypropylene, clean removal	170 lbs./in.

*ASTM Test Method D-3759

Note: This technical information and data should be considered representative or typical only and should not be used for specification purposes.

High Strength Filament Tapes

The World's Go-To Source for Filament Tapes Since 1946

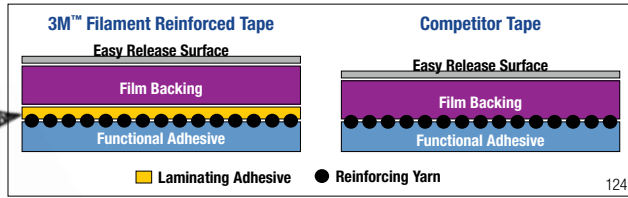

3M's laminating adhesive layer provides an extra measure of protection against tape delamination to help ensure tape strength and performance throughout the application. With 3M, you get more consistency, reliability and confidence.

Technologies Matched to the Applications

Choice of Adhesives

- **SR (Synthetic Rubber):** Versatile, good adhesion to many surfaces
- **MSR (Modified Synthetic Rubber):** Designed for adhesion to oily surfaces
- **RCT:** Designed for adhesion to recycled corrugate and other hard-to-stick-to-surfaces

Choice of Backings

- **Polypropylene:** Good abrasion, moisture and scuff resistance; excellent conformability
- **Polyester:** Tough, strong backing; handles and dispenses easily

Choice of Filament Types

- **Fiberglass:** Higher tensile strength for security and stretch resistance for stability
- **Polyester:** Higher elongation for better shock absorption and impact resistant



Bi-Directional Filament

- Superior cut and puncture resistance
- Extra box or package security against pilferage
- Highest adhesion in our high strength tape offering

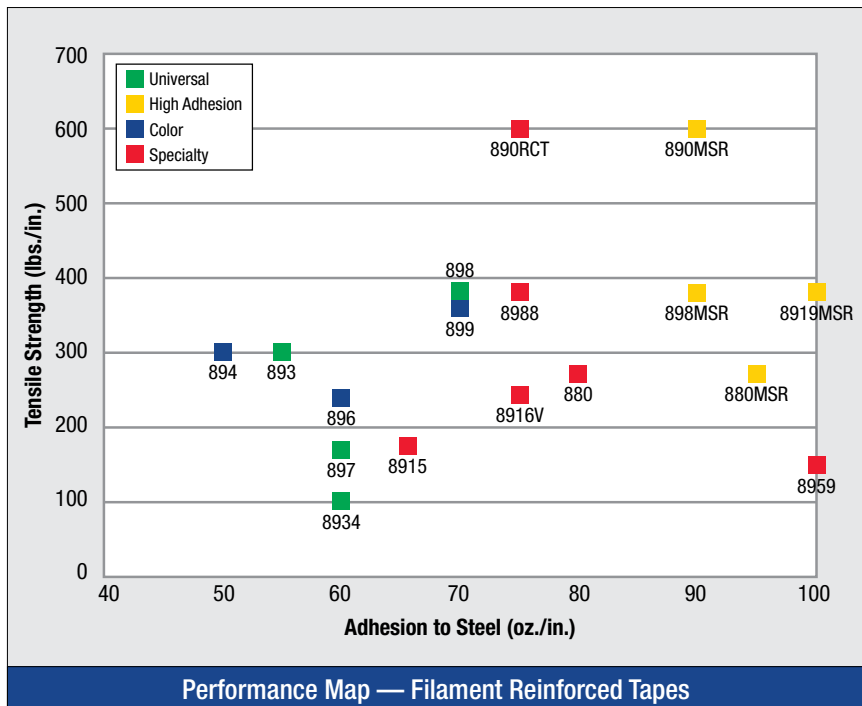

High Strength Filament Tapes

Product	Tensile Strength lb/in (N/100 mm)	Backing Material	Reinforcement	Total Thickness mils (mm)	Adhesive Type	Adhesion Strength oz/in (N/100 mm)	Elongation (%)	Backing Color	Typical Use and Comments
ASTM Test Method	D-3759			D-3652		D-3330			
Universal Filament									
898	380 (6655)	Polypropylene	Fiberglass	6.6 (0.168)	Synthetic Rubber (SR)	70 (77)	5	Clear	L-Clip box closure, General bundling and reinforcing; Very high strength, Versatile, Good adhesion to many substrates
893	300 (5254)	Polypropylene	Fiberglass	6.0 (0.152)	Synthetic Rubber (SR)	55 (60)	4.5	Clear	Box closing, palletizing, strapping, bundling and reinforcing; High strength
897	170 (2977)	Polypropylene	Fiberglass	6.0 (0.152)	Synthetic Rubber (SR)	60 (65)	3	Clear	Box closing, palletizing, strapping, bundling and reinforcing; Medium strength
8934	100 (1751)	Polypropylene	Fiberglass	4.0 (0.102)	Synthetic Rubber (SR)	60 (65)	3	Clear	Box closing, palletizing, strapping, bundling and reinforcing; Utility
Colored Filament									
899	360 (6305)	Polypropylene	Fiberglass	6.6 (0.168)	Synthetic Rubber (SR)	70 (77)	5	Red	General bundling and reinforcing; Red color for increased visible and detection
894	300 (5254)	Polypropylene	Fiberglass	6.0 (0.152)	Synthetic Rubber (SR)	50 (55)	4.5	Black	Pipe bundling and other outdoor applications; High UV resistance
896	240 (4203)	Polypropylene	Fiberglass	5.4 (0.137)	Synthetic Rubber (SR)	60 (66)	3	White	Heavy box closure, general bundling and reinforcing; White boxes, Color coding
High Adhesion Filament									
890MSR	600 (10500)	Polyester	Fiberglass	8.0 (0.203)	Modified Synthetic Rubber (MSR)	80 (88)	3	Clear/ Black	Metal coil closure; Good adhesion to oily surfaces
898MSR	380 (6655)	Polyester	Fiberglass	6.0 (0.152)	Modified Synthetic Rubber (MSR)	90 (99)	3	Clear	Metal coil closure; Good adhesion to oily surfaces
8919MSR	380 (6655)	Polyester	Fiberglass	7.0 (0.180)	Modified Synthetic Rubber (MSR)	100 (109)	3	Clear	Metal coil closure; Good adhesion to oily surfaces, Thicker backing for improved handling
880MSR	270 (4728)	Polyester	Polyester	7.7 (0.196)	Modified Synthetic Rubber (MSR)	95 (100)	19	Clear	Metal coil closure; Good adhesion to oily surfaces, High cut resistance
Specialty Filament									
890RCT	600 (10500)	Polyester	Fiberglass	8.0 (0.203)	Synthetic Rubber (RCT)	75 (82)	3	Clear	Basiloid, Heavy appliance lifting; Good adhesion to recycled corrugate
8988	380 (6655)	Polypropylene	Fiberglass	6.9 (0.175)	Synthetic Rubber (RCT)	75 (82)	3	Clear	L-Clip box closure; Good adhesion to recycled corrugate
880	270 (4728)	Polypropylene	Polyester	7.7 (0.196)	Synthetic Rubber (SR)	80 (88)	19	Clear/ Red	Pipe and conduit, bundling and color coding; Excellent shock resistance
8959	150 (2627)	Polypropylene	Bi-Directional Fiberglass	5.7 (0.145)	Synthetic Rubber (SR)	100 (109)	6	Clear	Heavy box closure, Splicing, Metal parts bundling; Bi-directional filament for excellent cut and puncture resistance; High adhesion
8916V	210 (3678)	Polypropylene	Fiberglass	6.8 (0.172)	Synthetic Rubber (SR)	75 (82)	3	Clear/ Blue	Appliance, Secure and stabilize parts; Clean removal, Thicker backing
8915	170 (2977)	Polypropylene	Fiberglass	6.0 (0.150)	Synthetic Rubber (SR)	65 (71)	3	Clear	Appliance, Secure and stabilize parts; Clean removal

Note: This technical information and data should be considered representative or typical only and should not be used for specification purposes.

Tensitized Polypropylene Tapes

Clean Removal

- MOPP (monoaxially-oriented polypropylene) tape construction
- High strength tapes that hold firm, remove cleanly with no adhesive residue
- Great adhesion to vinyl and other plastics, glass, painted and unpainted metals, or powder coated
- Holds shelving, racks, doors, panels, cords, other parts in place, from plant to install



12a



140

Bundle plastic, metal, stainless steel, glass, powdercoat or other coated electronic, appliance or automotive parts during assembly and transportation.

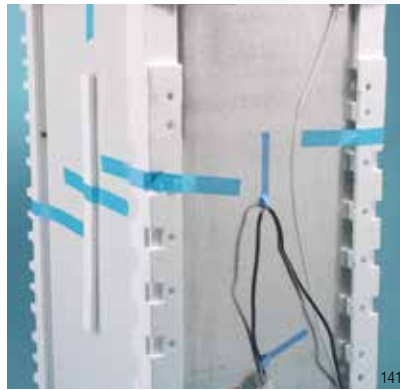

141

Hold packaging materials, spacers, corner boards, power cords and other hard-to-manage parts firmly in place.

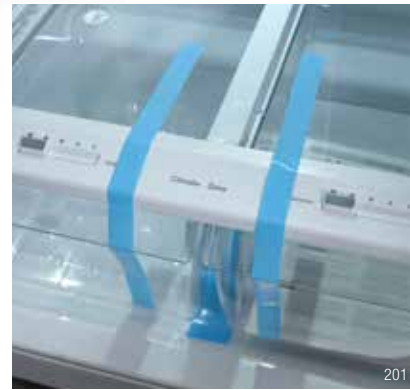

201

Appliance racks, shelves, drawers and doors can be secured, from plant to install, then removed cleanly with no adhesive residue.

Product	Tensile Strength lb/in (N/100 mm)	Backing Material	Reinforcement	Total Thickness mils (mm)	Adhesive Type	Adhesion Strength oz/in (N/100 mm)	Elongation (%)	Color	Typical Use and Comments
ASTM Test Method	D-3759			D-3652		D-3330			
8899HP	170 (2977)	Polypropylene	None	4.8 (0.12)	Synthetic Rubber	55 (60)	30	Blue/ Ivory/ White	Secure and stabilize parts, clean removal and high/low temperature performance
8898	160 (2802)	Polypropylene	None	4.6 (0.12)	Synthetic Rubber	75 (82)	32	Blue/ Ivory	Appliance, Secure and stabilize parts; Clean removal, High adhesion
860	110 (1926)	Polypropylene	None	2.8 (.071)	Synthetic Rubber	45 (49)	33	Black	General bundling and strapping; Utility grade for pallet unitizing

Note: This technical information and data should be considered representative or typical only and should not be used for specification purposes.

Scotch® Reinforced Strapping Tapes

The CLEAREST High-Strength Tape Available



Why 3M?

- **Strong:** Polypropylene backing extruded to create monofilament "ribs"
- **Secure:** Resists nicking, cutting, tearing or puncturing during handling
- **Clear:** No filaments to obstruct graphics

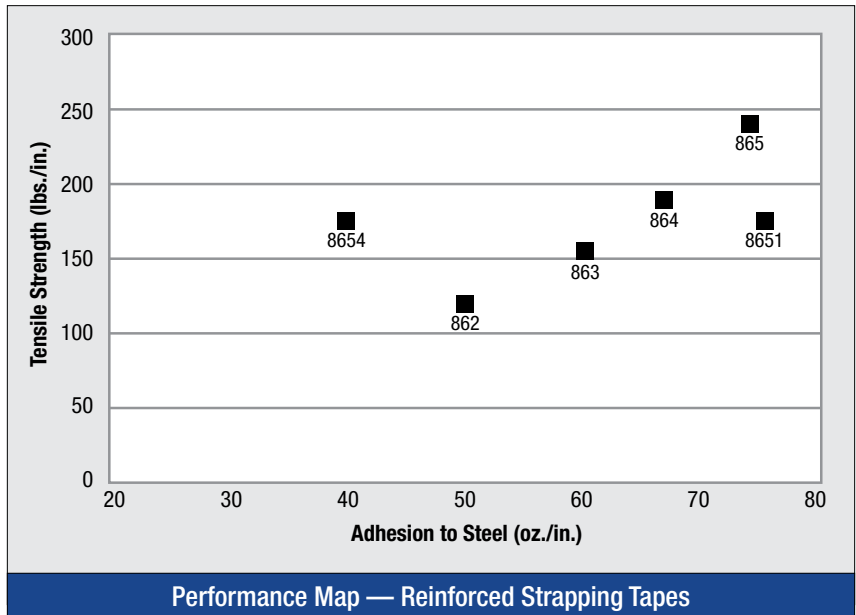
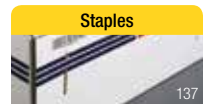

Product	Clarity to Showcase Marketing Content	Barcode Scan-able	Resists Nicks	Resists Abrasion	Does it Scratch?
Reinforced Strapping Tape	Yes	Yes	Yes	Yes	No
Reinforced Gummed Paper Tape	No	No	Yes	Somewhat	No
Staples	Somewhat	No	n/a	n/a	Yes
Filament Tape	Somewhat	No	Yes	Yes	No
Tensilized Polypropylene Tape	No	No	No	Yes	No

Product	Tensile Strength lb/in (N/100 mm)	Backing Material	Reinforcement	Total Thickness mils (mm)	Adhesive Type	Adhesion Strength oz/in (N/100 mm)	Elongation (%)	Color	Typical Use and Comments
ASTM Test Method	D-3759			D-3652		D-3330			
865	240 (4200)	Polypropylene	Polypropylene	6.4 (0.163)	Synthetic Rubber	74 (80)	30	Clear	Palletizing; L-Clip box closure; High clarity for use on highly graphic boxes; Bar code readable
864	190 (3325)	Polypropylene	Polypropylene	5.6 (0.142)	Synthetic Rubber	67 (73)	30	Clear	Palletizing; L-Clip box closure; High clarity for use on highly graphic boxes; Bar code readable
8651	175 (3064)	Polypropylene	Polypropylene	5.6 (0.142)	Synthetic Rubber	75 (82)	30	Clear	Palletizing; L-Clip box closure; High clarity for use on highly graphic boxes; Bar code readable
8654	175 (3064)	Polypropylene	Polypropylene	5.6 (0.142)	Synthetic Rubber	40 (44)	30	Clear	Cold temperature applications 35–50°F (2–13°C)
863	155 (2713)	Polypropylene	Polypropylene	5.0 (0.127)	Synthetic Rubber	60 (65)	30	Clear	Palletizing; L-Clip box closure; High clarity for use on highly graphic boxes; Bar code readable
862	120 (2100)	Polypropylene	Polypropylene	4.6 (0.117)	Synthetic Rubber	50 (54)	30	Clear/Black	Pipe Bundling; Black for UV resistance

Note: This technical information and data should be considered representative or typical only and should not be used for specification purposes.

Scotch® Stretchable Tapes

Tape That Gets Stronger As It's S-T-R-E-T-C-H-E-D

- Adhesive “de-tackifies” when stretched: holds in place but won’t damage carton graphics, shipping instructions or other pallet information when removed
- 650% stretch factor: 55-meter roll yields 357 meters of tape
- Creates ventilated load for shipment of time- and temperature-sensitive goods
- More stability — less waste

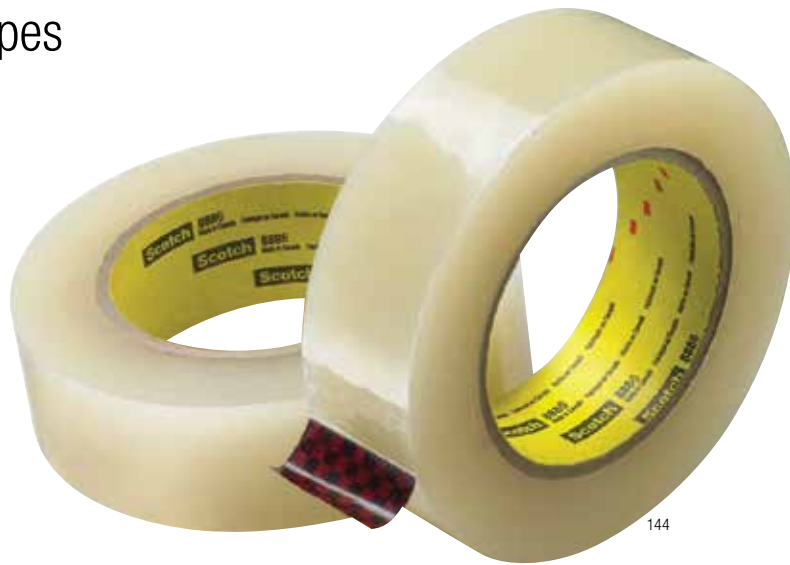

144



145

High yield! One 55-meter roll can unitize 60 or more A- or B-style pallets for intra-plant movement.



146

“X”-pattern can contain loads for shipment anywhere.



147

Less waste! Compare the 3M™ Stretchable Tape waste “ball” on the left versus the size of typical stretch film waste on the right.



148



149



89

Scotch® Stretchable Tape Dispenser H38

Hand-held dispenser with tensioning/stretching brake for use with Scotch® Stretchable Tapes.

Product	Tensile Strength lb/in (N/100 mm)	Backing Material	Total Thickness mils (mm)	Adhesive Type	Adhesion Strength oz/in (N/100 mm)	Elongation (%)	Color	Comments
ASTM Test Method	D-3759		D-3652		D-3330			
8886	28 (490)	Polyethylene	6.6 (0.168)	Synthetic Rubber	65 (71)	720	Clear	Load containment
8884	20 (350)	Polyethylene	5.0 (0.127)	Synthetic Rubber	70 (77)	710	Clear	Palletizing for intra-plant movement; Load containment; For hand application using Scotch® Stretchable Tape Dispenser H38

Note: This technical information and data should be considered representative or typical only and should not be used for specification purposes.

Custom Packaging Solutions



3M™ Carry Handles — Applied at Retail Checkout

Convenience For Your Customer

- Quickly and easily transform bulky purchases into travel-friendly packages
- Custom print! Put your BRAND in consumer's hands
- Custom size to meet your store profile
- Great alternative to large retail shipping bag. Save a bag...offer a handle

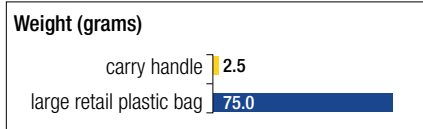

Reduce plastic waste by 97% by offering a carry handle.

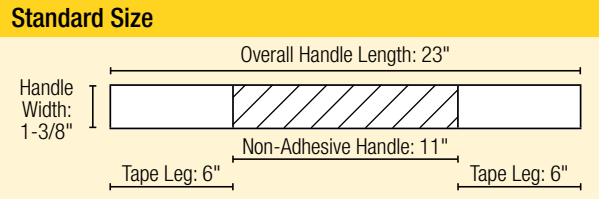

Product	Weight Holding Capacity (lbs)	Tape Material	Total Thickness mils (mm)	Tensile Strength lb/in (N/100 mm)	Adhesive Type	Adhesion oz/in (N/100 mm)	Pads per Case	Handles per Case	Handle (width x length)	Tape Leg Length
3M™ Carry Handles — Padded for Individual Application							25 Handles per Pad			
8310	10	Polypropylene	3.1 (0.079)	35 (613)	Synthetic Rubber	55 (60)	110	2750	1" x 17"	3"
8315	15	Polypropylene	3.2 (0.081)	35 (613)	Synthetic Rubber	55 (60)	80	2000	1-3/8" x 23"	6"
8320	20	Polyester	3.5 (0.089)	67 (1174)	Synthetic Rubber	78 (85)	110	2750	1" x 17"	3"
8330	30	Polyester	3.5 (0.089)	67 (1174)	Synthetic Rubber	78 (85)	80	2000	1-3/8" x 23"	6"
8340	40	Reinforced Strapping Tape	5.6 (0.142)	190 (3325)	Synthetic Rubber	67 (73)	80	2000	1-3/8" x 23"	6"
8350	50	Filament Tape	7.7 (0.196)	270 (4728)	Synthetic Rubber	80 (88)	80	2000	1-3/8" x 23"	6"

3M™ Carry Handles — Pre-Applied By Manufacturer

Give Your Products a Lift

- Differentiate your on-shelf appeal — customers will associate convenience with your brand
- Customers will **select** and **pick up** your brand
- Printed handles **communicate** — drive brand awareness, augment or replace other package information
- **Convenience:** Promo packs and up-sized SKUs can be easily carried from store to car or bus to home or office
- Ask your 3M Packaging Specialist for details on automated application equipment



3M™ Carry Handle Tape 8347



Product	Weight Holding Capacity (lbs)	Tape Material	Adhesive Type	Adhesion oz/in (N/100 mm)	Tensile Strength lb/in (N/100 mm)	Total Thickness mils (mm)	Roll Type	Roll (W x L)	Core Dia.
3M™ Carry Handles — Long-Length Rolls for In-Line Automated Application									
8347	20	Polypropylene	Synthetic Rubber	50 (55)	103 (1800)	2.56 (0.065)	Level-wound	1" x 5470 yd	6"
8346HP	20	Polyester	Synthetic Rubber	52 (57.0)	67 (1174)	3.4 (0.086)	Level-wound	25mm x 3000m	6"

Note: This technical information and data should be considered representative or typical only and should not be used for specification purposes.

Scotch® Multipack Tapes

Economical and Sustainable Alternative to Shrink Films, Banding, Boxes and Bags

- Effective, low-cost way to bundle consumer products into multipacks and value packs
- Significant reduction in consumer waste
- Clear, strong tape holds firmly and removes cleanly without damaging the primary package graphics
- Custom-print tape option delivers your branding and promotional messaging, multipack barcoding



Marketing messages can be custom printed on this transparent, repositionable tape.

Discrete adhesion highlights primary packaging.

A Full Selection of Bundling Options

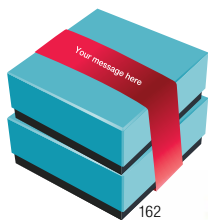

Stacked



Side-by-Side



Upright



Custom

Carry handle option for convenience

Environmental Impact

See the comparison between the Scotch® Multipack Tape 694 and the shrink wrapped grouping: 5,000,000 kits of three 400mL packages per year.

Multipack Solution



10,064 lbs.
(4,565 kg)
of plastic/year

Shrink Wrapped



23,479 lbs.
(10,650 kg)
of plastic/year

vs.

Reduction of
13,415 lbs.
(6,085 kg)
of plastic/year



Represents 304,000 water bottles.

Average of 20g/500mL bottle. For illustrative purposes only.

Product	Color	Backing Material	Backing Thickness mils (mm)	Total Thickness mils (mm)	Tensile Strength lb/in (N/100 mm)	Adhesive Type	Adhesion to Steel oz/in (N/100 mm)	Elongation (%)	Comments
694	Clear	Polypropylene	1.6 (0.040)	1.9 (0.049)	23 (409)	Acrylic	4.78 (5.23)	77	Clean removal tape designed for multi-unit primary packaging; Apply manually or with automated equipment; 649CP is a custom printed version
694CP									
699	Clear	Polypropylene	1.6 (0.041)	2.6 (0.066)	30 (525)	Acrylic	46 (50)	160	Designed for bundling multi-unit primary packaging; Combine with 3M™ Carry Handles for bundling pouches; Apply manually or with automated equipment; 699CP is a custom printed version
699CP									

Note: This technical information and data should be considered representative or typical only and should not be used for specification purposes.

Bag Sealing Tapes

Stronger, Faster, Clearer Closure for Eye-Popping Woven Polypropylene Bags

Featuring tough, transparent tapes that instantly seal a wide range of bag types and materials. Scotch® Bag Sealing Solutions can accelerate your entire end-of-line operation, while improving the visual impact of your packaging.

- Cut downtime and potentially **double** your throughput over traditional bag closing systems
- Improve bag appearance and enhance shelf appeal with woven polypropylene bags
- Eliminate the hassles of traditional mechanical stitchers and the messy glue pots that come with adhesive closure systems
- Give customers an easy-open alternative
- Reduce bag leakage and improve quality control



3M™ Transparent Film Tape 8470 with Scotch® Easy Open Tear Strip Tape 8622



Custom printed tape for proof of factory seal

Product	Color	Backing Material	Backing Thickness mils (mm)	Total Thickness mils (mm)	Tensile Strength lb/in (N/100 mm)	Adhesive Type	Adhesion to Steel oz/in (N/100 mm)	Elongation (%)	Comments
8469	Clear	Polyester	2.2 (0.051)	3.0 (0.076)	63 (1104)	Synthetic Rubber	75 (81)	130	Excellent tear, impact and abrasion resistance; 8469CP is a custom printed version
8469CP									
8470	Clear	Polypropylene	2.0 (0.051)	3.1 (0.079)	36 (615)	Synthetic Rubber	55 (60)	160	Good adhesion to variety of surfaces including polypropylene, paper, polyethylene; 8470CP is a custom printed version
8470CP									
8622	Red	Reinforced Polypropylene	8.4 (0.21)		190 (3320)	n/a No Functional Adhesive		30	Easy open feature when used with Scotch® Film Tape for heavy bag sealing

3M™ Tape Pads

No Dispenser? No Problem!

- **Portable** “peel and stick” convenience, 25 sheets per pad
- **Adheres** to bags, boxes, plastic film, powder coats, metals and glass
- **Removable tab** for easy handling
- **Stores easily** in pockets, drawers, tool boxes and part carts
- Used to repair, patch, seal, protect, reinforce, close and trap



3M™ Packaging Tape Pad 3750P



3M™ Tape Sheets 822

Product	Sheet Size(s)	Color	Tape Material	Total Thickness mil (mm)	Tensile Strength lb/in (N/100 mm)	Adhesive Type	Adhesion Strength oz/in (N/100 mm)	Elongation (%)	Tab
802	4" x 6"	Matte	Acetate	2.0 (0.05)	15 (265)	Acrylate	1.5 (1.6)	15	Repositionable matte finish, write on surface
809G	Custom Size	Transparent, Red, Yellow	Polypropylene	3.1 (0.079)	35 (613)	Synthetic Rubber	55 (60)	160	Removable or Permanent
809GP	Custom Size w/Custom Print	Transparent, Red, Yellow	Polypropylene	3.1 (0.079)	35 (613)	Synthetic Rubber	55 (60)	160	Removable or Permanent
809S	Custom Size, w/Custom Backsheet	Transparent	Polypropylene	3.1 (0.079)	35 (613)	Synthetic Rubber	55 (60)	160	Removable or Permanent
819	4" x 6"	Clear	Bi-Directional Filament	5.7 (0.145)	150 (2627)	Synthetic Rubber	100 (109)	6	Removable
822	4" x 6"	Transparent	Polypropylene	3.1 (0.079)	35 (613)	Synthetic Rubber	55 (60)	160	Removable
3750P	2" x 6"	Transparent	Polypropylene	3.1 (0.079)	35 (613)	Synthetic Rubber	55 (60)	160	Removable

Note: This technical information and data should be considered representative or typical only and should not be used for specification purposes.

Scotch® Bag Conveying Tapes

- A high performance tape designed to convey a food grade preservation bag through the bag manufacturer's forming and packaging process
- Product constructions with or without reinforcement can meet a range of price/performance needs
- The pressure sensitive adhesive is specifically formulated to provide consistent adhesion to polyethylene



Product	Tensile Strength lb/in (N/100 mm)	Backing Material	Reinforcement	Adhesive Type	Adhesion Strength oz/in (N/100 mm)	Total Thickness mils (mm)	Elongation (%)	Color	Width(s)	Core Size
ASTM Test Method	D-3759				D-3330	D-3652				
8631	160 (2800)	Polypropylene	Polypropylene	Synthetic Rubber	67 (73)	6.0 (0.15)	30%	Clear	1/4"	6"
8635	140 (2452)	Polyethylene	None	Synthetic Rubber	62 (68)	4.0 (0.102)	60%	Black	6mm, 9mm	6"

3M™ Hang Tabs

- Clear, durable, polyester tabs with a pressure-sensitive adhesive for easy in-store repair of damaged packaging such as torn punches in chipboard header cards
- Clear tabs do not obscure packaging graphics — showcases existing packaging graphics and messaging
- Pre-cut, bendable tab format for convenience and ease of use
- Sticks to most product or packaging surfaces for store display applications



Hole Styles



J-Hook

Consumer-friendly option, encourages item selection from anywhere on peg

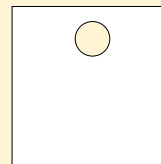

Round Hole

For single-wire pegs

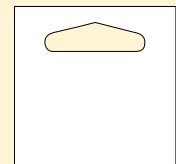

Delta Hole

For wider double-wire pegs or self-centers on standard pegs

Product	Size (height x width)	Hole Style	Color	Hang Tabs per Pad	Backing Material	Total Thickness mil (mm)	Adhesive Type	Adhesion Strength oz/in (N/100 mm)
1072	7/8" x 1-3/8"	J-Hook	Clear	Individual	Polyester	25.8 (0.66)	Synthetic Rubber	175 (192)
1074	1" x 2"	Round	Clear	10 per pad	Polyester	13.5 (0.34)	Synthetic Rubber	55 (60)
1075	2" x 2"	Delta	Clear	10 per pad	Polyester	13.5 (0.34)	Synthetic Rubber	55 (60)
1076	2" x 2"	Round	Clear	10 per pad	Polyester	13.5 (0.34)	Synthetic Rubber	55 (60)

Note: This technical information and data should be considered representative or typical only and should not be used for specification purposes.

Scotch® Pouch Tapes

Strong, Low-Profile Attachment Solution

- “Trap it” with unique 3M tape construction — strong adhesive tape area on the edges frame the large, clear non-adhesive window area in the middle
- Attach documents, packing lists, invoices, literature, catalogs, brochures, or even product samples, small part packets or other merchandise
- Polypropylene backing/synthetic rubber adhesive sticks well to corrugate and many other substrates
- Custom-print option can personalize your message



Scotch® Pouch Tape Dispenser M727 with Scotch® Pouch Tape 824 — Available in rolls for easy dispensing at pack stations.



Scotch® Pouch Tape Sheets 830 — Available in pads for portable back-pocket convenience. No liners help keep work areas clean of debris.

Product	Individual Pouch Size (h x w)	Printed Message	Applications	Core Size	Material Type	Total Thickness mils (mm)	Tensile Strength lb/in (N/100 mm)	Adhesive Type	Adhesion Strength oz/in (N/100 mm)	Dispenser Options
Pads										
830	5" x 6"	"Documents Enclosed"	25 per pad	—	Polypropylene	2.5 (0.064)	30 (525)	Synthetic Rubber	50 (55)	—
830CP	5" x 6"	Custom Print	25 per pad	—	Polypropylene	2.5 (0.064)	30 (525)		50 (55)	—
830RCT	5" x 6" 6" x 10"	"Documents Enclosed"	25 per pad	—	Polypropylene	2.6 (0.066)	30 (525)		46 (50)	—
832	6" x 10"	"Documents Enclosed"	25 per pad	—	Polypropylene	2.5 (0.064)	30 (525)		50 (55)	—
832CP	6" x 10"	Custom Print	25 per pad	—	Polypropylene	2.5 (0.064)	30 (525)		50 (55)	—
8240P	5" x 6"	"Packing List Enclosed"	25 per pad	—	Polypropylene	2.5 (0.064)	30 (525)		50 (55)	—
Rolls										
824	5" x 6"	"Documents Enclosed"	333 per roll	3"	Polypropylene	2.5 (0.064)	30 (525)	Synthetic Rubber	50 (55)	M727 or M797
824RCT	5" x 6" 5" x 8" 6" x 10"	"Documents Enclosed"	500 per roll	3"	Polypropylene	2.6 (0.066)	30 (525)		46 (50)	M727 or M797
8240	5" x 6"	"Documents Enclosed"	500 per roll	3"	Polypropylene	2.5 (0.064)	30 (525)		50 (55)	M727 or M797
825	5" x 6"	"Documents Enclosed"	250 per roll	1"	Polypropylene	2.5 (0.064)	30 (525)		50 (55)	—
827	5" x 8"	"Documents Enclosed"	500 per roll	3"	Polypropylene	2.5 (0.064)	30 (525)		50 (55)	M727 or M797
	6" x 8"	"Documents Enclosed"	500 per roll	3"	Polypropylene	2.5 (0.064)	30 (525)		50 (55)	M797
	6" x 10"	"Documents Enclosed"	400 per roll	3"	Polypropylene	2.5 (0.064)	30 (525)		50 (55)	M797
829	5" x 8"	"Packing List Enclosed"	333 per roll	3"	Polypropylene	1.9 (0.048)	22 (385)		40 (44)	M727 or M797
828CP	144 mm x 254 mm	Custom Print Custom Size	—	3"	Polypropylene	2.5 (0.064)	30 (525)		50 (55)	M797

Label Protection Tapes

Protect Labeled Shippers, Mailers, Envelopes, Tubes, Drums, Tubs

- Tape material options for use on wide range of substrates, in many applications including outdoor use
- High clarity for sharp read-through accuracy
- Bright color tape option draws attention to important label content



Product	Roll Width(s) Available	Roll Length	Color	Backing Material	Total Thickness mils (mm)	Tensile Strength lb/in (N/100 mm)	Adhesive Type	Adhesion Strength oz/in (N/100 mm)	Elongation (%)	Comments
821	2", 3", 4", 5", 6"	72 yd.	Pink	Acetate	2.5 (0.063)	12 (210)	Acrylic	25 (27)	15	Low-glare matte finish. Write-on surface; Hand-tearable — no dispenser needed
856	1", 1.5", 2", 3", 4", 6"	72 yd.	Clear	Polyester	2.0 (0.051)	25 (438)	Acrylic	20 (22)	90	Excellent transparency and resistance to abrasion, moisture and chemicals; Go-to option for outdoor applications
3565	96mm, 120mm	100m	Clear	Polypropylene	1.9 (0.048)	22 (385)	Synthetic Rubber	40 (44)	160	Excellent transparency and conformability; Resists tearing, splitting, moisture, abrasion and smudges
3765	96mm, 120mm, 144mm	132m	Clear	Polypropylene	1.5 (0.038)	20 (350)	Acrylic	22 (24)	119	Good transparency; Recommended for cold temperature applications

Note: This technical information and data should be considered representative or typical only and should not be used for specification purposes.

3M™ Packing List Envelopes

Wide Variety of Choices for Document Control and Protection

- Convenient peel-and-stick document protection
- Non-printed and printed with standard messages
- Custom sizes and/or custom printed messages
- Reclosable 3M™ Zipper Closure Envelope is available in two sizes
- Polyethylene backing/synthetic rubber adhesive/paper liner
- Backing thickness: 2.0 mil;
Total thickness: 5.0 mil









Easy Inspection — For cross border shipping and other inspection situations, zipper closure envelopes open easily and close securely. Tough construction resists moisture and abrasion.



Secure Adhesion — High tack pressure sensitive adhesive on the back of the envelope grabs on contact and holds securely even to curved and flexible surfaces.

T (Top Printed)

<p>T1 PACKING LIST/ INVOICE ENCLOSED 4.5" x 5.5" 1,000/case</p>  <p style="writing-mode: vertical-rl; transform: rotate(180deg);">side-load</p>	<p>T1 INV INVOICE ENCLOSED 4.5" x 5.5" 1,000/case</p>  <p style="writing-mode: vertical-rl; transform: rotate(180deg);">side-load</p>	<p>T3 PACKING LIST/ INVOICE ENCLOSED 7" x 5.5" 1,000/case</p>  <p style="text-align: center;">top-load</p>
<p>T1 PL PACKING LIST ENCLOSED 4.5" x 5.5" 1,000/case</p>  <p style="writing-mode: vertical-rl; transform: rotate(180deg);">side-load</p>	<p>T2 PACKING LIST/ INVOICE ENCLOSED 4.5" x 6" 1,000/case</p>  <p style="writing-mode: vertical-rl; transform: rotate(180deg);">side-load</p>	<p>T4 PACKING LIST/ INVOICE ENCLOSED 5.5" x 10" 1,000/case</p>  <p style="writing-mode: vertical-rl; transform: rotate(180deg);">side-load</p>

NP (Non-Printed)

<p>NP1 NO PRINT (CLEAR) 4.5" x 5.5" 1,000/case</p>  <p style="writing-mode: vertical-rl; transform: rotate(180deg);">side-load</p>	<p>NP6 NO PRINT (CLEAR) 9.5" x 12" 1,000/case</p>  <p style="writing-mode: vertical-rl; transform: rotate(180deg);">side-load</p>
<p>NP2 NO PRINT (CLEAR) 4.5" x 6" 1,000/case</p>  <p style="writing-mode: vertical-rl; transform: rotate(180deg);">side-load</p>	<p>NP9 NO PRINT (CLEAR) 7" x 6" 1,000/case</p>  <p style="text-align: center;">top-load</p>
<p>NP3 NO PRINT (CLEAR) 5.5" x 7" 1,000/case</p>  <p style="text-align: center;">top-load</p>	<p>FED1 NO PRINT (PERFED) 6.75" x 10.75" 500/case</p>  <p style="text-align: center;">top-load</p>
<p>NP4 NO PRINT (CLEAR) 5.5" x 10" 1,000/case</p>  <p style="writing-mode: vertical-rl; transform: rotate(180deg);">side-load</p>	<p>NP5 NO PRINT (CLEAR) 7" x 10" 1,000/case</p>  <p style="writing-mode: vertical-rl; transform: rotate(180deg);">side-load</p>

F (Full Face Printed)

<p>F1 PACKING LIST/ INVOICE ENCLOSED 4.5" x 5.5" 1,000/case</p>  <p style="writing-mode: vertical-rl; transform: rotate(180deg);">side-load</p>
--

Zipper Closure Envelope

<p>NPZ-L NO PRINT (CLEAR) 8.5" x 11.5" 500/case</p>	<p>NPZ-XL NO PRINT (CLEAR) 10" x 12.5" 500/case</p>
---	---



182

Remote Sensing Tapes

3M™ Prismatic Remote Sensing Target 3000X

- Micro-cube corner sheeting made of a flexible synthetic resin which will perform well with polarized light
- Smooth, clear surface can be cleaned easily
- Aggressive pressure sensitive adhesive provides an excellent bond to most clean, wax-free, dry, relatively non-porous, weather resistant surfaces
- Adhesive is protected by a liner which is removed at the time of application and the reflector is pressed into position



3M™ Retroreflective Materials make it easy to design sensing systems based on simple, inexpensive photoelectric sensors. They increase readability, range and accuracy with greater control.

3M™ Scotchlite™ Photoelectric Grade Smooth Surface Sheeting 7590

- Durable, flexible, wide angle, smooth-surface, retroreflective sheeting, specially designed for use in photoelectric applications such as retroreflective labels or marks
- Sheeting consists of special lens elements enclosed within a transparent resin, having a smooth flat outer surface and is supplied with a low-temperature, pressure-sensitive adhesive protected by a removable liner



3M™ Scotchlite™ Photoelectric Grade Smooth Surface Sheeting 7590

3M™ Scotchlite™ High Gain Reflective Sheeting 7610

- High gain reflective industrial grade sheeting, exposed-lens, retroreflective, plastic-based material, pre-coated with a pressure-sensitive adhesive
- Adhesive is covered with a removable protective liner that offers a very high retroreflective efficiency and small optical elements



Scotch® Photoelectric Scanning Tape 7800

Scotch® Photoelectric Scanning Tape 7800

- Exposed-lens retroreflective tape with a pressure-sensitive adhesive that is designed for use as expendable code marks in automatic warehouse or conveyor operations
- This product affords exceptional contrast with its background for increased accuracy, reliability, and depth-of-field in photoelectric sorting and classification systems and may be employed with automatic on-line applicators or manual dispensers for identification or simple sortation of paperboard shipping containers

Product	Tape Structure (Backing/Adhesive)	Liner	Format	Typical Luminance Factor		Thickness – Applied (in.)	Temperature Resistance – Intermittent °F (°C)	Lens	Color
				-4 deg.	45 deg.				
3000X	Micro-cube corner sheeting/ acrylic adhesive/paper liner	Yes	Sheets and Rolls	1000x	1500x	0.020	150 (65.5)	Protected	White with linear pattern
7590	Sealed reflective tape/ low temperature synthetic resin/liner	Yes	Rolls	200x	80x	0.007	400 (204)	Protected	Opaque White
7610	Exposed reflective tape/ synthetic resin/liner	Yes	Rolls	900x	700x	0.004	250 (121)	Exposed	Light Gray
7800	Exposed-lens reflective tape/ synthetic resin/linerless	No	Rolls	200x	100x	0.007	500 (260)	Exposed	Medium Gray

Note: This technical information and data should be considered representative or typical only and should not be used for specification purposes.

Scotch® Tear Strip Tapes

Easy Access With a Simple Pull

For easy opening of packages ranging from overnight envelopes to corrugated fiberboard, the recipient simply grabs and pulls the exposed end of a Scotch® Tear Strip Tape.

- Tensilized polypropylene tears through paper board and light to heavy weight fiber board with high pull-rate success
- Eliminates knives or other sharp edges from opening envelopes and panels



For overnight courier envelopes and mail order boxes, Scotch® Tear Strip Tape 8621 provides superior resistance to edge nicking and tearing compared to other film tear strip tapes without reinforcement.



Scotch® Tear Strip Tape 8626 with superior tensile strength tears through medium to heavy weight corrugated fiberboard as used in household detergent boxes.

Product	Backing Material	Reinforcement	Adhesive Type	Tensile Strength lb/in (N/100 mm)	Total Thickness mils (mm)	Adhesion Strength oz/in (N/100 mm)	Elongation (%)	Color	Comments
ASTM Test Method				D-3759	D-3652	D-3330			
8621	Polypropylene	Polypropylene	Synthetic Rubber	160 (2802)	5.2 (0.13)	64 (70)	30	White	Reinforced tear strip for improved nick resistance on a wide range of light- to heavy-weight paperboard and corrugated fiberboard
8624	Polypropylene	None	Synthetic Rubber	160 (2802)	4.5 (0.114)	65 (71)	30	Blue	Medium-strength tear strip for light- to medium-weight fiberboard packaging materials
8626	Polypropylene	None	Synthetic Rubber	220 (3853)	6.2 (.157)	75 (82)	30	Ivory	Heavy duty high-strength tear strip for medium to heavy-weight fiberboard packaging materials

Note: This technical information and data should be considered representative or typical only and should not be used for specification purposes.

Glossary

This glossary is compiled by the Pressure Sensitive Tape Council (PSTC) and 3M (terms identified with an asterisk). PSTC is the North American trade association for tape manufacturers and affiliate suppliers, dedicated to helping the industry produce quality pressure sensitive adhesive tape products in the global marketplace.

Abrasion Resistance

The ability of a tape to withstand rubbing and still function satisfactorily.

Acrylic Adhesive*

A pressure sensitive, viscoelastic blend of acrylic-based materials which may be modified by tackifying additives. Acrylic adhesives are a very broad class of materials and come in many types to achieve different properties.

Adhesion to Backing

The bond produced to the backing of the same tape or another tape backing.

Adhesive Deposit or Residue

Adhesive that is pulled away from the tape upon removal and remains on the surface to which it has been applied.

Adjustable Case Sealer

A case sealer that must be manually adjusted for box width and height. Accepts runs of one box size at a time.

Article Letters*

Letters if a MSDS does not exist on a product.

Backing

A relatively thin flexible material to which the adhesive is applied. Theoretically, any material that is reasonably flat, thin and flexible can be used as a tape backing.

Backsize

An occlusive coating applied to the non-pressure sensitive side of a porous backing, such as paper, in order to provide a satisfactory surface that the pressure sensitive adhesive side can contact when the tape is wound into a roll.

Caliper

The thickness (as of a sheet of paper) measured under specified conditions. See also THICKNESS.

Co-extruded*

Refers to film extruded in individual layers with the possibility of different raw materials in each layer providing unique combined film properties.

Conformability*

The ability for a tape to make arcs, circles, go into depressions, go over protrusions and still stay in one piece without slivering, tape lifting, necking down.

Containment

To confine and hold in place.

Controlled Unwind*

When a balance is achieved between too low of an unwind, allowing the tape to prematurely unwind from its own backing, or too high, causing premature slivering or breaking when unwinding from its roll.

Elastomer

An elastic, polymeric substance, such as natural or synthetic rubber.

Elongation (Stretch, Ultimate Elongation)

The distance a tape will stretch in the machine or cross direction before breaking under controlled conditions, expressed as a percentage of original length. Elongation is not necessarily an indication of conformability.

Extruded*

A manufacturing process where material is forced through a nozzle (like extruded film or backing). Better for lay-flat than skived.

FOL

Full overlap.

Filaments

Thin, longitudinal yarns or threads of glass, polyester, nylon or other high strength materials.

Holding Power (Shear Adhesion, Shear Resistance)

The ability of a tape to resist static forces applied in the same plane as the backing. Usually expressed in a time required for a given weight and length of tape to shear free from a vertical panel.

Hot Melt (Pressure Sensitive Adhesive)

A pressure sensitive adhesive, applied to the backing in hot liquid form, which then cools to form a conventional pressure sensitive adhesive.

Humidity

The moisture content of the air. Actual humidity is the number of grams of moisture in the air at any given time. Relative humidity is the percent of moisture relative to the maximum that air at any given temperature can retain without precipitation.

Impact Resistance (Shock Resistance)

The ability of a tape to resist sudden impacts, pulls, or shocks as may sometimes be encountered by packages in transit.

L-Clip

Tape seal applied over the edge of non-RSCs with one leg down the side and the other on the top and/or bottom.

Moisture Vapor Transmission Rate

A measure of the rate of water vapor transmission through a pressure sensitive product usually measured in grams per square meter per 24 hours.

MOPP

Monoaxially-oriented polypropylene tape construction.

NPE*

An NPE number is used to designate an experimental product. NPE products are often provided to customers for evaluation purposes only, and may or may not be commercialized.

Non-RCS

All box structures other than RSC (Regular Slotted Carton).

Off-Core

A roll of tape in which the layers are in correct alignment, but the tape is displaced sideways on the core.

Opacity

The ability of a tape to prevent the transmission of light.

Pad

Pre-cut, tape strips stacked on a pad for easy one-at-a-time removal.

Glossary (cont.)

PE*

The abbreviation for polyethylene. Usually extruded in a single (mono) layer.

Peel Adhesion

The force per unit width required to break the bond between a pressure sensitive adhesive tape and the surface to which it has been applied when the tape is peeled back at a controlled angle at a standard rate and condition.

PLE

Packing List Envelope.

Pouch Tape

Tape with adhesive-free area within a perimeter of pressure sensitive adhesive. When applied the adhesive-free area forms a containment pouch.

PP*

Abbreviation for polypropylene. Usually manufactured as a single (mono) layer via a casting process.

Pressure Sensitive

A term commonly used to designate a distinct category of adhesive tapes and adhesives which in dry form (solvent/water free) are aggressively and permanently tacky at room temperature and that firmly adhere to a variety of dissimilar surfaces upon mere contact without the need of more than finger or hand pressure. These products require no activation by water, solvent, or heat in order to exert a strong adhesive holding force toward such materials as paper, plastic, glass, wood, cement, and metal. They have sufficient cohesive holding power and elastic nature so that, despite their aggressive tackiness, they can be handled with the fingers and removed from smooth surfaces without leaving a residue.

Quick Stick (Finger Tack, Initial Adhesion, Wet Grab)

See TACK.

Random Case Sealer

A case sealer that automatically adjusts for case width and height. Typically used for runs of different box sizes.

Recouperage

To salvage goods within a container that has broken or opened during shipment.

Release Force

The measure of the force required to separate a unit width of pressure sensitive tape from a release coated surface at a controlled angle and speed.

Remote Sensing

The technique or process of obtaining data or images from a distance.

Retroreflective

Surface, material, or device that reflects light back to its source.

RGT

Reinforced Gum Tape.

RSC

Regular Slotted Carton.

Rubber Adhesive*

A pressure sensitive, viscoelastic blend of polymeric rubber-based materials and tackifying resin. The rubber materials may be natural or synthetic. Rubber adhesives are a very broad class of materials and come in many types to achieve different properties.

Shear Adhesion

The time required, under specified test conditions (surface area, weight load), to slide a standard area of pressure sensitive tape from a standard flat surface in a direction parallel to the surface.

Single Faced (Coated)

A tape to which a pressure sensitive adhesive is applied to only one side of the backing.

Solvent/Chemical Resistant*

Ability to resist common solvents or chemicals.

Surface Energy (Surface Wetting Ability)

The measure of surface tension in dynes. The lower the surface energy of a substrate, the more difficult it becomes for an adhesive or coating to wet out that surface.

Tack

The property of a pressure sensitive adhesive that allows it to adhere to a surface under very slight pressure. It is determined by the ability of the adhesive to wet quickly the surface it contacts.

Tear Resistance

The force required to propagate a tear in a tape in a given direction after the tear has been initiated.

Telescoping

A sideways sliding of the tape layers, one over another, such that the roll looks like a funnel or a telescope, usually occurring over a period of time.

Tensile Strength

The force required to break a unit width of tape by controlled pulling on opposite ends of the piece.

Thickness (Caliper, Gauge)

The perpendicular distance from one surface of either a tape, backing or adhesive to the other, usually expressed in mils, thousandths of an inch or millimeters. This is usually measured under controlled slight pressure with a special gauge.

TSCA*

Toxic Substances Control Act.

U-Clip

Tape seal applied to an RSC carton with tape legs down both sides of the carton and across the center seam.

UL 723*

UL 723 deals mainly with flammability.

Unwind or Unwind Adhesion

The force required to remove tape from a roll under prescribed conditions.

Water Vapor Transmission (WVTR)

The weight of water vapor allowed through a controlled area of tape within a specified time period and under controlled conditions.

*Compiled by 3M.

Numerical Index

200a.....	8	802	34	3073	20	8470CP	34
200a3.....	8	809G	34	3073CP	21	8621	39
302	20	809GP	34	3199	21	8622	34
305	20	809S	34	3565	36	8624	39
311	20	819	34	3723	21	8626	39
311+	20, 21	821	36	3732	21	8631	35
313	20	822	34	3750P	34	8635	35
315	20	824	36	3765	36	8651	29
351	20	824RCT	36	3771	21	8654	29
353	20	825	36	3772	21	8884	30
355	20	827	36	3775	21	8886	30
355CP	21	828CP	36	3779	21	8898	28
369	20	829	36	5910	23	8899HP	25, 28
371	20	830	36	6141	21	8915	27
371CP	21	830CP	36	6142	21	8916V	27
372	20	830RCT	36	6143	21	8919MSR	27
372CP	21	832	36	6144	21	8934	25, 27
373	20	832CP	36	6145	21	8959	27
373CP	21	856	23, 36	6146	21	8988	27
375	20	860	25, 28	6147	21	a20.....	8
375CP	21	862	25, 29	7000a Pro.....	8	a20-s.....	8
600	23	863	29	7000a3 Pro.....	8	a80.....	9
605	23	864	29	7000r Pro.....	10	a80-3.....	9
610	23	865	29	7000r3 Pro.....	10	a80b.....	9
640	23	880	25, 27	7590	38	a80b-3.....	9
660	23	880MSR	27	7610	38	a80-t.....	9
681	23	890MSR	25, 27	7800	38	C22	15
690	23	890RCT	27	8000a.....	9	C23	15
694	33	893	25, 27	8000a3.....	9	C25	15
694CP	33	894	27	8004	23	F1.....	37
699	33	896	27	8240	36	FED1.....	37
699CP	33	897	25, 27	8240P	36	H10	15
700a-s.....	8	898	25, 27	8310	32	H12	15
800ab.....	9	898MSR	27	8315	32	H100	15
800ab3.....	9	899	27	8320	32	H121	15
800af.....	9	1072	35	8330	32	H122	15
800af3.....	9	1074	35	8340	32	H123	15
800asb.....	9	1075	35	8346HP	32	H128	15
800r	10	1076	35	8347	32	H129	15
800r3.....	10	3000X	38	8350	32	H130	15
800rf	10	3071	20	8469	34	H131	15
800rf3.....	10	3071CP	21	8469CP	34	H133	15
800rks.....	10	3072	20	8470	34	H150	15

Numerical Index (cont.)

H153	15	HR933	15	NP5	37	S634	12, 15
H180	15	M82	15	NP6	37	S867	12
H183	15	M96	15	NP9	37	S867II	12
H190	15	M707	15	NPZ-L	37	T1	37
H192	15	M727	15	NPZ-XL	37	T1 INV	37
H320	15	M797	15	P52	15	T1 PL	37
HB900	15	M900	15	P52W	15	T2	37
HB901	15	M920	15	P56	15	T3	37
HB902	15	NP1	37	P56W	15	T4	37
HB903	15	NP2	37	P400	15	W100	15
HR80	15	NP3	37	P410	15	W200	14, 15
HR83	15	NP4	37	P448	15		

Product Name Index

3M™ AccuGlide™ Taping Heads

2+	11
2+ SSTL	11
3	11
HST	11
LHB	11
NPH	11

3M-Matic™ Adjustable Case Sealers

200a	8
200a3	8
700a-s	8
800ab	9
800ab3	9
800af	9
800af3	9
800asb	9
7000a Pro	8
7000a3 Pro	8
8000a	9
8000a3	9
a20	8
a20-s	8
a80	9
a80-3	9
a80b	9
a80b-3	9
a80-t	9

3M-Matic™ Random Case Sealers

800r	10
800r3	10
800rf	10
800rf3	10
800rks	10
7000r Pro	10
7000r3 Pro	10

Bag Conveying Tapes

8631	35
8635	35

Bag Sealing Tapes

8469	34
8469CP	34
8470	34
8470CP	34
8622	34

Box Sealing Tapes

302	20
305	20
311	20
313	20
315	20
351	20
353	20
355	20
355CP	21
369	20
371	20
371CP	21
372	20
372CP	21
373	20
373CP	21
375	20
375CP	21
600	23
605	23
610	23
640	23
660	23
681	23
690	23
856	23
3071	20
3071CP	21
3072	20
3073	20
3723	21
3073CP	21
3199	21

Box Sealing Tapes (cont.)

3771	21
3772	21
3775	21
3779	21
5910	23
6141	21
6142	21
6143	21
6144	21
6145	21
6146	21
6147	21

Carry Handles

8310	32
8315	32
8320	32
8330	32
8340	32
8346HP	32
8347	32
8350	32

Cold Temperature Tapes

311+	21
3723	21

Custom Printed Tapes

355CP	21
371CP	21
372CP	21
373CP	21
375CP	21
3071CP	21
3073CP	21

Hang Tabs

1072	35
1074	35
1075	35
1076	35

High Strength Filament Tapes

860	25
862	25
880	25, 27
880MSR	27
890MSR	25, 27
890RCT	27
893	25, 27
894	27
896	27
897	25, 27
898	25, 27
898MSR	27
899	27
8899HP	25
8915	27
8916V	27
8919MSR	27
8934	25, 27
8959	27
8988	27

Label Protection Tapes

821	36
856	36
3565	36
3765	36

Light Duty Packaging Tapes

600	23
605	23
610	23
640	23
660	23
681	23
690	23
856	23
5910	23
8004	23

Product Name Index (cont.)

Multipack Tapes

694	33
694CP	33
699	33
699CP	33

Non-RSC Solutions

S867	12
S867II	12

Packing List Envelopes

F1	37
FED1	37
NP1	37
NP2	37
NP3	37
NP4	37
NP5	37
NP6	37
NP9	37
NPZ-L	37
NPZ-XL	37
T1	37
T1 INV	37
T1 PL	37
T2	37
T3	37
T4	37

Pouch Tapes

824	36
824RCT	36
825	36
827	36
828CP	36
829	36
830	36
830CP	36
830RCT	36
832	36
832CP	36
8240	36
8240P	36

Recycled Corrugate Tapes

311+	20
3071	20
3072	20
3073	20

Reinforced Strapping Tapes

862	29
863	29
864	29
865	29
8651	29
8654	29

Remote Sensing Tapes

3000X	38
7590	38
7610	38
7800	38

Security Tapes

3199	21
3732	21
3734	21
3771	21
3772	21
3775	21
3779	21

Tape Pads

802	34
809G	34
809GP	34
809S	34
819	34
822	34
3750P	34

Stretchable Tapes

8884	30
8886	30

Tape Dispensers

C22	15
C23	15
C25	15
H10	15
H12	15
H100	15
H121	15
H122	15
H123	15
H128	15
H129	15
H130	15
H131	15
H133	15
H150	15
H153	15
H180	15
H183	15
H190	15
H192	15
H320	15
HB900	15
HB901	15
HB902	15
HB903	15
HR80	15
HR83	15
HR933	15
M82	15
M96	15
M707	15
M727	15
M797	15
M900	15
M920	15
P52	15
P52W	15
P56	15
P56W	15
P400	15
P410	15

Tape Dispensers (cont.)

P448	15
S634	12, 15
W100	15
W200	14, 15

Tear Strip Tapes

8621	39
8624	39
8626	39

Tensitized Polypropylene Tapes

860	28
8898	28
8899HP	28

Water Activated Tapes

6141	21
6142	21
6143	21
6144	21
6145	21
6146	21
6147	21