

OPERATOR'S MANUAL & SAFETY INSTRUCTIONS



3M™ Cut-Off Wheel Tool

PN 33579	76 mm (3 in.)	20,000 RPM
PN 33581	101 mm (4 in.)	20,000 RPM



English



TABLE OF CONTENTS

TABLE OF CONTENTS	1
IMPORTANT SAFETY INFORMATION	3
SUMMARY OF DEVICE LABELS CONTAINING SAFETY INFORMATION	3
EXPLANATION OF SIGNAL WORD CONSEQUENCES	4
GENERAL POWER TOOL SAFETY PRECAUTIONS:	4
 WARNING	5
 CAUTION	6
NOTICE	6
INTENDED USE	6
PRODUCT CONFIGURATION/SPECIFICATIONS	6
EXPLODED TOOL (PARTS) VIEW	7
PARTS LIST	7
MAINTENANCE/LUBRICATING AND OPERATING INSTRUCTIONS	8
DECLARATION OF CONFORMITY	10
3M LIMITED ONE YEAR WARRANTY	11



IMPORTANT SAFETY INFORMATION

Please read, understand, and follow all safety information contained in these instructions prior to the use of this device. RETAIN THESE INSTRUCTIONS FOR FUTURE REFERENCE.

<p>Read the Safety Data Sheets (SDS) before using any materials.</p>    <p>Contact the suppliers of the workpiece materials and abrasive materials for copies of the SDS if one is not readily available.</p>	<p>WARNING</p> <p>Exposure to DUST generated from workpiece and/or abrasive materials can result in lung damage and/or other physical injury.</p> <p>Use dust capture or local exhaust as stated in the SDS. Wear government-approved respiratory protection and eye and skin protection.</p> <p>Failure to follow this warning can result in serious lung damage and/or physical injury.</p>
--	---



HEALTH HAZARD BY DUST – CALIFORNIA PROPOSITION 65 STATEMENT



WARNING! Various dust created by power sanding, sawing, grinding, drilling and other construction activities contains chemicals known [to the State of California] to cause cancer, birth defects or other reproductive harm. Some examples of these chemicals are:

- Lead from lead-based paints,
- Crystalline silica from bricks and cement and other masonry products, and
- Arsenic and chromium from chemically treated lumber.



Your risk from exposure to these chemicals varies, depending on how often you do this type of work. To reduce your exposure to these chemicals:

- Work in a well-ventilated area, and
- Work with approved safety equipment, such as those dust masks that are specially designed to filter out microscopic particles.
- Wash hands after handling

SUMMARY OF DEVICE LABELS CONTAINING SAFETY INFORMATION

Markings	Description
	WARNING: READ AND UNDERSTAND INSTRUCTION MANUAL BEFORE OPERATING TOOL.
	WARNING: ALWAYS WEAR APPROVED EYE PROTECTION.
	WARNING: ALWAYS WEAR APPROVED HEARING PROTECTION
	Direction of rotation
	WARNING: HAND/WRIST/ARM INJURY CAN OCCUR WITH PROLONGED EXPOSURE TO VIBRATION
20,000 RPM	Maximum rotational speed
90 PSIG / 6.2 BAR MAX	Maximum air pressure

EXPLANATION OF SIGNAL WORD CONSEQUENCES

 WARNING:	Indicates a potentially hazardous situation, which, if not avoided, could result in death or serious injury and/or property damage.
 CAUTION:	Indicates a potentially hazardous situation, which, if not avoided, may result in minor or moderate injury and/or property damage.
NOTICE:	Indicates a potentially hazardous situation, which, if not avoided, may result in property damage.

GENERAL POWER TOOL SAFETY PRECAUTIONS:

For multiple hazards, read and understand the safety instructions before installing, operating, repairing, maintaining or changing accessories on, or working near the power tool. Failure to do so can result in serious bodily injury.

WORK AREA SAFETY

- Keep work area clean and well lit. Cluttered or dark areas invite accidents.
- Dust can be highly combustible. Keep work area clean.
- Keep bystanders away while operating a power tool. Distractions can cause you to lose control.

PERSONAL SAFETY

- As compressed air is used as the power source, it must be remembered that compressed air can be dangerous when used incorrectly. The user should take time to read and understand these operating instructions fully.
- Immediately release the start trigger in the event of any disruption of pressure. Do not attempt to restart until the disruption has been corrected.
- Do not use the power tool if it has been damaged.
- The tool RPM should be checked on a regular basis to ensure proper operating speed.
- Never operate the tool with loose, broken or missing parts.
- Do not carry the tool by the air hose. Always be careful to prevent the tool from being started when carrying the tool with the air supply connected.
- Do not use damaged abrasives or wrong type of accessories.
- Take care to avoid entanglement with the moving parts of the tool with clothing, ties, hair, cleaning rags or loose hanging objects. If entangled, stop air supply immediately to avoid contact with moving tool parts.
- Always use personal protective equipment. Always wear eye protection. Protective equipment such as gloves, dust mask, non-skid safety shoes, hard hat or hearing protection used for appropriate conditions will reduce personal injuries.
- Do not overreach. Keep proper footing, balance and grip at all times. This enables better control of the power tool in unexpected situations.
- Be aware of torque reaction developed by the Cut-Off Wheel Tool.
- Do not allow the tool to free spin without taking precautions to protect any persons or objects from the rupture of the abrasive cut-off wheel.
- Keep hands clear of the spinning cut-off wheel during use.
- Fixture workpiece such that the cut slot is kept at a constant or increasing width during operation.
- Do not allow persons to use this power tool if unfamiliar with these instructions or operation of the tool.
- Always disconnect this tool from the air supply when attaching/adjusting/replacing abrasives and accessories or when starting any maintenance/cleaning tasks.
- Whenever performing maintenance procedures, use care to avoid exposure to any hazardous substances deposited on the tool as a result of work processes.
- If the tool appears to malfunction, remove from use immediately and arrange for service and repair.

WARNING

To reduce the risks associated with impact from abrasive product or tool breakup, sharp edges, hazardous pressure, rupture, vibration and noise:

- Read, understand and follow the safety information contained in these instructions prior to the use of this tool. Retain these instructions for future reference.
- If you notice any abnormal noise or vibration when operating the product, immediately discontinue its use and inspect for worn or damaged components (mounting hardware, abrasive product, etc.). Correct or replace the suspect component. If abnormal noise or vibration still exists, return the tool to 3M for repair or replacement. Refer to warranty instructions.
- Only personnel who are properly trained should be allowed to service this tool.
- Operators and other personnel must always wear protection for eyes, hearing (or ears), and respiratory system, when in the work area or while operating this product. Follow your employer's safety policy for Personal Protective Equipment (PPE) and/or ANSI Z87.1 or local/national standards for eyewear and other personal protective equipment requirements.
- Proper eye protection must be worn at all times.
- Tool shall not be operated in the presence of bystanders.
- Wear leather apron or other protective apparel, taking into consideration the type of work being done.
- Never exceed marked maximum input pressure (90 psi / 0.62Mpa / 6.2 Bars). Exceeding maximum marked pressure rating will result in device operating at an unintended speed and therefore enhances the possibility of serious injury.
- Make sure the tool is disconnected from its air source before servicing, inspecting, maintaining, cleaning, and before changing abrasive product.
- Practice safety requirements. Work alert, have proper attire, and do not operate tool under the influence of alcohol or drugs.
- Only use wheel retainers (flanges) and wheel arbors supplied by 3M.
- Never use this tool with Depressed Center wheels.
- Prior to use, or if dropped or jammed, inspect wheel retainers and wheel arbors and abrasive product for possible chips, cracks or other damage and ensure the abrasive product is correctly secured. If damaged, or if safety labels cannot be read, replace with new abrasive product, wheel retainers, wheel arbor, and/or labels available from 3M.
- Never use a damaged Cut-Off tool unit until it has been repaired!
- Never over-ride or disable the safety features of the start-stop control such that it is in the on position.
- Never operate this tool without all guards or safety features in place and in proper working order.
- Prior to use, ensure guard is oriented to protect the operator from flying fragments and is properly secured.
- If the tool is jammed, shut off the tool and ease it free. Ensure the abrasive product is correctly secured.
- Use only with mounting hardware recommended by 3M; check with 3M for mounting hardware requirements.
- Do not use cut-off wheel tool for side grinding.
- Never install and use router bits in a Cut-Off tool.
- Never allow this tool to be used by children or untrained people.
- Do not leave an unattended tool connected to an air source.

To reduce the risks associated with skin abrasion, burns, cuts, or entrapment:

- Keep hands, hair, and clothing away from the cutting part of the tool.
- Wear suitable protective gloves while operating tool.
- Never install cut-off wheels in a tool which is unguarded.
- Do not touch the rotating parts during operation for any reason.
- Do not force tool or use excessive force when using tool.

To reduce the risk of all hazards associated with vibration:

- If any physical hand/wrist discomfort is experienced, work should be stopped promptly to seek medical attention. Hand, wrist and arm injury may result from repetitive work, motion and overexposure to vibration.

To reduce the risks associated with loud noise:

- Always wear hearing protection while operating this tool. Follow your employer's safety policy or local/national standards for personal protective equipment requirements.

To reduce the risks associated with fire or explosion:

- Do not operate the tool in explosive atmospheres, such as in the presence of flammable liquids, gases or dust. The abrasives are able to create sparks when working material, resulting in the ignition of the flammable dust or fumes.
- Refer to SDS of material being worked as to potential for creating fire or explosion hazard.

To reduce the risks associated with hazardous dust inhalation or eye/skin exposure:

- Use appropriate respiratory and skin protection, or local exhaust as stated in the SDS of the material being worked on.
- Exposure to dust generated in the workplace and/or abrasive materials can result in lung damage and/or other physical injury.
- Use dust capture or local exhaust as stated on the SDS. Wear government approved respiratory protection and eye and skin protection.
- Failure to follow this warning can result in serious lung damage and/or physical injury.

To reduce the risk of foot injury from dropped tools:

- Wear safety shoes with a reinforced toe to help protect your feet from injury caused by a dropped tool. Safety footwear comes in a variety of styles and is widely available. Choose footwear that offers traction for your work site.

To reduce the risks associated with hazardous voltage:

- Do not allow this tool to come into contact with electrical power sources as the tool is not insulated against electrical shock.

CAUTION

To reduce the risk associated with whipping or hazardous pressure-rupture:

- Ensure supply hose is oil resistant and is properly rated for required work pressure.
- Do not use tools with loose or damaged air hoses or fittings.
- Be aware that incorrectly installed hoses and fittings might unexpectedly come loose at any time and create a whipping/ impact hazard.

To reduce the risk associated with fly off of abrasive product or parts:

- Use care in attaching abrasive product and mounting hardware; follow the instructions to ensure that they are securely attached to the tool before use or free-spinning.
- Never point this product in the direction of yourself or another person, or start tool unintentionally.
- Never over-tighten accessory fasteners.

NOTICE

To maximize the life of the system:

- Do not operate tool without a properly attached 3M™ abrasive.
- Reference Maintenance/Lubricating and Operating Instructions section for proper lubrication procedures.

INTENDED USE

The 3M™ Cut-Off Wheel Tool is intended for use in industrial locations, and used only by skilled, trained professionals in accordance with the instructions in this manual. The 3M™ Cut-Off Wheel Tool optimizes the performance of 3M™ Cut-Off Wheels (sold separately) by delivering a fast, smooth, cut and the power needed to cut through metal including carbon and stainless steel. It should only be used for such applications and within its marked capacity and rating. PN 33579 uses a 76 mm (3 in) diameter abrasive, while PN 33581 uses a 101 mm (4 in) diameter abrasive. Only accessories specifically recommended by 3M should be used with this tool. Use in any other manner or with other accessories could lead to unsafe operating conditions.

- Do not operate tool in water or in an excessively wet application.
- Do not use abrasive products that have a Max RPM less than the Max RPM rating marked on the tool.
- Maintain labels and nameplates. These carry important information. If unreadable or missing, contact a 3M service facility for a free replacement.

At the end of its useful life, recycle or dispose of tool according to federal, state, and local regulations.

PRODUCT CONFIGURATION/SPECIFICATIONS

Model No.	Wheel Size In. (mm)	Spindle Thread	Product Net Wt lb (kg)	Height In. (mm)	Length In. (mm)	Width In. (mm)	Motor hp (W)	Noise Level dBA Pressure (Power)	Vibration Level m/s ²	Uncertainty Km/s ²
33579	3 (76)	1/4 in – 28	1.94 (0.88)	3.14 (79.6)	7.73 (196)	3.50 (89)	0.70 (522)	86.0 (97.0)	17.5 3.02 (If cut-off wheel used)	5.50
33581	4 (101)	1/4 in – 28	2.03 (0.92)	3.42 (86.9)	7.73 (196)	4.65 (118)	0.70 (522)	84.5 (95.5)	27.8 5.36 (If cut-off wheel used)	8.81

* Declared noise level; measurements carried out in accordance with EN ISO 15744. It is recommended to wear ear protection while using this tool.

** Declared vibration level in accordance with standard EN ISO 28927.

IMPORTANT NOTE: The noise and vibration values stated are from laboratory testing in conformity with stated codes and standards and are not sufficient risk evaluation for all exposure scenarios. Values measured in a particular work place may be higher than the declared values. Exposure to high noise levels can cause permanent, disabling hearing loss and other problems, such as tinnitus (ringing, buzzing, whistling or humming in the ears). Therefore, risk assessment and the implementation of appropriate controls for these hazards are essential. The actual exposure values and amount of risk or harm experienced to an individual is unique to each situation and depends upon the surrounding environment, the way in which the individual works, the particular material being worked, work station design, as well as upon the exposure time and the physical condition of the user. 3M cannot be held responsible for the consequences of using declared values instead of actual exposure values for any individual risk assessment.

EXPLODED TOOL (PARTS) VIEW

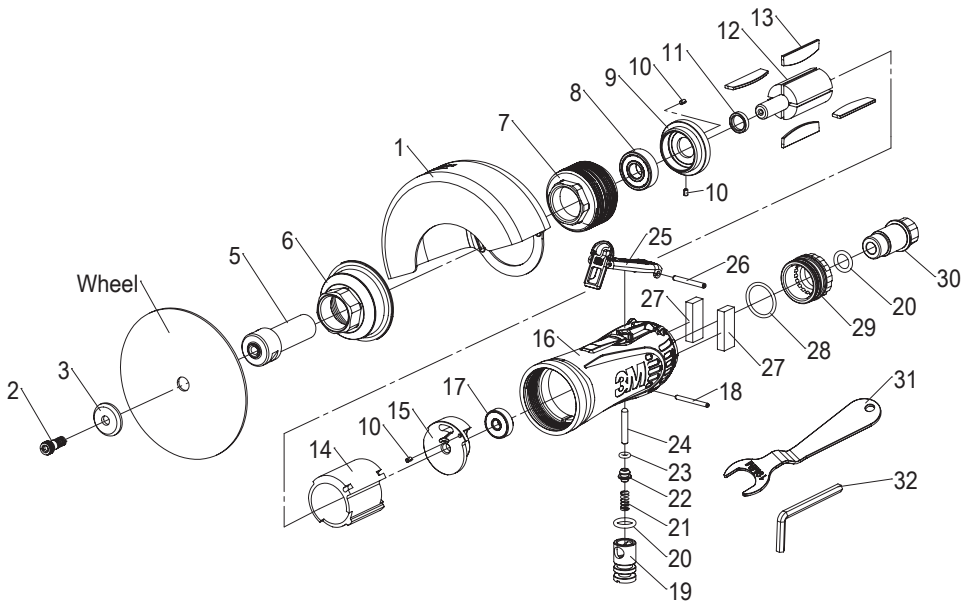

PARTS LIST

ITEM	DESCRIPTION	QTY
1	3 in. (76mm) Wheel Guard	1
	4 in. (101mm) Wheel Guard	1
2	Hex. Screw	1
3	Spacer	1
5	Spindle	1
6	Housing Cap	1
7	Lock Ring	1
8	Ball Bearing (6000ZZ)	1
9	Front End Plate	1
10	Spring Pin (ø 2.5×4)	3
11	Spacer	1
12	Rotor	1
13	Rotor Blade	4
14	Cylinder	1
15	Rear End Plate	1
16	Housing	1

ITEM	DESCRIPTION	QTY
17	Ball Bearing (626ZZ)	1
18	Spring Pin (ø 2.5×26)	1
19	Valve Screw	1
20	O-Ring	2
21	Spring	1
22	Throttle Valve	1
23	O-Ring	1
24	Valve Shaft	1
25	Safety Lever Assembly	1
26	Spring Pin (ø 3×25)	1
27	Muffler	2
28	O-Ring	1
29	Exhaust Sleeve	1
30	Inlet Bushing	1
31	Wrench (19 mm)	1
32	Wrench, 3/16" L-Key	1

MAINTENANCE/LUBRICATING AND OPERATING INSTRUCTIONS

PRIOR TO THE OPERATION

The tool is intended to be operated as a hand held tool. It is always recommended that while using the tool, operators stand on a solid floor, in a secure position with a firm grip and footing. Be aware the cut-off wheel tool can develop a torque reaction. Reference "GENERAL POWER TOOL SAFETY PRECAUTIONS" section.

Use a clean lubricated air supply that will give a measured air pressure at the tool of 6.2 bar (90 psig) when the tool is running with the trigger fully depressed. It is recommended to use an approved 9.52 mm (3/8 in) x 8 m (25ft) maximum length airline. It is recommended that the tool be connected to the air supply as shown in Figure A.

Do not connect the tool to the airline system without incorporating an easily accessible air shut off valve. It is strongly recommended that an air filter, regulator and lubricator (FRL) be used as shown in Figure A as this will supply clean, lubricated air at the correct pressure to the tool. In any case appropriate air pressure regulators shall be used at all times while operating this tool where the supply pressure exceeds the marked maximum of the tool. Details of such equipment can be obtained from your tool distributor. Adjust airline lubricator equipment such that two drops of 3M™ Air Tool Lubricant PN 20451 (or equivalent 10 centistoke oil) per minute are provided through the hose to the air inlet of the tool. If excessive oil is noted in the exhaust air, reduce the drip rate of the airline lubricator equipment accordingly. If such equipment is not used, the tool should be manually lubricated.

To manually lubricate the tool, disconnect the airline and put two to three drops of 3M™ Air Lubricant PN 20451 (or equivalent 10 centistoke oil) into the air inlet of the tool. Reconnect tool to the air supply and run tool slowly for a few seconds to allow air to circulate the oil. If the tool is used frequently, lubricate it on a daily basis or lubricate it if the tool starts to slow or lose power. It is recommended that the air pressure at the tool be 6.2 bar (90 psig) while the tool is running so the maximum RPM is not exceeded. The tool can run at lower pressures but should never be run higher than 6.2 bar (90 psig). If run at lower pressure the performance of the tool is reduced.

Recommended Airline Size – Minimum	Recommended Maximum Hose Length	Air Pressure		
		Maximum Working Pressure	6.2 Bar	90 psig
9.52 mm (3/8 in)	8 meters (25 feet)	Recommended Minimum	N/A	N/A

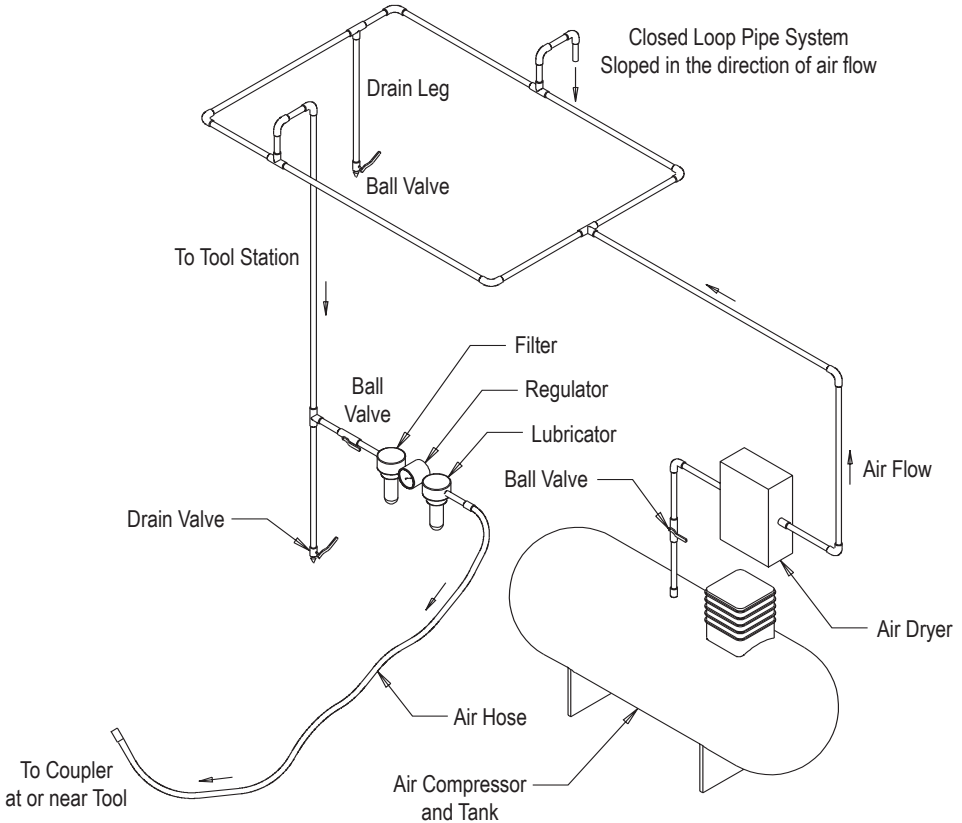

GENERAL SET UP AND USE:

- Read all instructions before using this tool. All operators must be fully trained in its use and aware of all safety rules. All service and repair must be carried out by trained personnel.
- The tool RPM should be checked on a regular basis to ensure proper operating speed.
- Make sure the tool is disconnected from the air supply.
- Select a suitable abrasive cut-off wheel and secure it to the mounting shaft using the wheel retainer and wheel arbor supplied with the tool. Be careful to center the cut-off wheel on the wheel arbor before tightening the wheel retainer nut. Do not over tighten the wheel retainer or you will crack the wheel.
- Always wear required safety equipment when using this tool.
- Always disconnect the air supply to the tool before fitting, adjusting or removing the abrasive cut-off wheel.
- Use only 3M approved parts.
- Prior to installing any abrasive cut-off wheel, always check that its marked maximum operating speed is equal to or higher than the rated speed of this tool.
- If the tool has been serviced or rebuilt, check to ensure that the maximum tool RPM is not exceeded and that there is no excessive tool vibration.

Cut-Off Wheel Mounting Instructions.

1. Disconnect tool from airline.
2. Remove Hex Screw (item 2) and the Spacer (item 3), using the 3/16" L-Key (item 32) and using the 19 mm wrench (item 31) to hold the Spindle (item 5).
3. After the old cut-off wheel has been removed from the tool, inspect Spindle to ensure that the threads are free of debris and undamaged.
4. Place a new cut-off wheel on Spindle. Ensure center hole of new cut-off wheel engages properly with the lip on the Spindle. Place Spacer onto the new cut-off wheel and align with center hole. Reinsert Hex Screw.
5. Use the 19 mm wrench to hold the Spindle and tighten the Hex Screw using the 3/16" L-Key.

SETTING & TESTING TOOL SPEED:

1. Ensure the Trigger is not depressed.
2. Connect the compressed airline.
3. Press the Trigger slowly and increase force until tool is at full speed.
4. Use a Rotary Tachometer to check the speed.
5. Check speed regularly.

EU Declaration of Conformity

Company 3M Company	Division Automotive Aftermarket Division
Address 3M Center, Building 223-6N-01 St. Paul, MN 55144 USA	

Does hereby declare under our sole responsibility that this equipment or product(s) comply with the applicable essential requirements of the legislation listed below; along with the referenced standards or specifications.

Object - Product name and/or model number(s) and/or unique identification: Part (Model) Number(s): PN 33579, PN 33581	
Type and/or description and/or intended purpose or equipment class and/or particular conditions applicable to the use of the Object: 3M™ Cut-Off Wheel	
Serial number or range (if applicable): Range: 00116001 - thru - 36599999; where the last 3 digits represent the sequential unit manufactured on the Julian date indicated in the first 3 characters, of the year indicated in the next 2 characters.	

Illustration - Typical

Conforms to the following Union harmonization legislation; together with all amendments to-date:

Directives: Machinery Directive – 2006/42/EC	
Standards / specifications / provisions complied with; in full or in part as applicable:	
EN ISO 12100:2010	Safety of machinery - General principles for design - Risk assessment and risk reduction (ISO 12100:2010)
EN ISO 11148-7:2012	Hand-held non-electric power tools – Safety Requirements – Part 7: Grinders (ISO 11148-7:2012)
EN ISO 28927-1:2009	Hand-held portable power tools – Test methods for evaluation of vibration emission – Part 1: Angle and Vertical Grinders (ISO 28927-1:2009)
EN ISO 15744:2008	Hand-held non-electric power tools - Noise measurement code - Engineering method (grade 2) (ISO 15744:2002)