



Engineered Metalworking Solutions

Complete solutions.

Commitment to Innovation and Quality.

Complete solutions. It's what you've come to expect from 3M, the leading supplier for metalworking industries. For over 100 years, 3M has been a proven leader, providing advanced technology and innovative solutions for increased productivity, enhanced efficiency and improved manufacturing processes.

This commitment to innovation continues with ongoing new product introductions focused on the complete metalworking experience. Today, 3M Metalworking Products encompass a broad spectrum of solution-specific products from personal safety to abrasives and high-strength adhesives. 3M presents a growing portfolio with each addition to this line of advanced solutions designed for all metalworking processes from start to finish.



New for 2014



1 3M™ Cubitron™ II Abrasives. The unmatched cutting power and long life of 3M™ Cubitron™ II Abrasives, made with the revolutionary 3M precision-shaped grain, has been making metalworking history since 2009. Since then, we've continued to expand the Cubitron II product line with more products and more grades. New additions to the 2014 Metalworking catalog:

- **3M™ Cubitron™ II Bonded Abrasives — Depressed Center Grinding Wheels** provide superfaster cut, are long lasting and require less pressure for heavy weld removal and other grinding applications; **Cut-off Wheels** have high cut rates to help improve your productivity; **Cut & Grind Wheels** are designed for use as both a grinding wheel and a cut-off wheel; ideal for cutting, grinding, gouging, notching and more!
- **3M™ Cubitron™ II Flap Discs 967A** — The power of 3M precision-shaped grain now available in a flap disc construction for one step grinding and finishing.
- **3M™ Cubitron™ II Belts** — Expanding line now includes the **994F Belt** for high pressure automated grinding on carbon steel and aluminum; **997F Belt** for high pressure automated applications on stainless, cobalt chrome, and nickel alloy; **947A Belt** is flexible for low-medium pressure off-hand applications on stainless, mild steel and aluminum.

2 Scotch-Brite™ Products. Make tough jobs easier! New additions to this family of abrasives include **Scotch-Brite Random Orbital (RO) Discs** for prepping bare metal for paint faster and more consistently with comfort and control; **Scotch-Brite 7447/7448 PRO** with new fiber coating technology that provides a fast cut and consistent finish, helps reduce the time it takes to scuff, prep, or finish parts prior to paint, and is available in hand pads, discs, jitterbug sheet pads, and rolls; **Scotch-Brite Rapid Cut Wheels** get more bite with the cutting power of 3M precision-shaped grain for fast, easy weld blending and deburring.

3 3M™ Power Tools. Optimize your abrasive performance with a complete system that will help you get the job done right. New additions to our line-up include:

- 3M™ Elite Non-Vacuum Random Orbital Sander — **28708**
- 3M™ Random Orbital Sander – 2-Hand — **28335**
- 3M™ Sander/Buffer — **28773**
- 3M™ Pistol Grip Random Orbital Disc Sander — **27353**
- 3M™ Cut-off Wheel Tool (upgraded, replaces model 20234) — **28771**
- 3M™ Match and Finish Sander — **28659**
- 3M™ Die Grinder, 1 HP — **28770**

4 3M™ Scotch-Weld™ Acrylic Adhesives (DP8810NS, DP8805NS, DP8405NS). These Next Generation Structural Acrylic Adhesives bond faster and deliver higher impact resistance than conventional Acrylic Adhesives. With reduced odor and non-flammable formulations, these products offer an 18 month shelf life and do not require refrigeration, helping you to build better products and improve productivity.

5 3M™ Speedglas™ 100 Series Helmets. This popular series of welding helmets provides safety and excellent optical clarity — in style. Check out the new Boneyard, Xterminator, and Tribute models!

6 3M™ Peltor™ X-Series Earmuffs. Designed for protection against moderate-to-high level industrial noise. Lightweight lower profile earmuffs for increased compatibility with other personal protective equipment. Newly designed spacer, foam liners and ear cushions help improve attenuation.

Bonded Abrasives Systems 1

3M™ Depressed Center Grinding Wheels	1–2
3M™ Cut and Grind Wheels	3
3M™ Cut-Off Wheels	4–5
3M™ Power Tools	6
Accessories	6

Right Angle Disc Systems 7

3M™ Fibre Discs	7–10
3M™ Flap Discs	11–14
Scotch-Brite™ Discs	15–18
Hook-and-Loop Discs	16–17
Center Hole Discs	17
TN Quick Change Discs	18
Surface Conditioning Disc Packs	18
3M™ Power Tools	18–19
Accessories	19–20

Roloc™ Systems 21

3M™ Cubitron™ II Roloc™ Discs	22–23
3M™ Roloc™ Discs	24–26
Scotch-Brite™ Roloc™ Discs	27–29
Roloc™ D/F Discs	30
3M™ Roloc™ Disc Packs	31
3M™ Power Tools	32
Accessories	33–34

Random Orbital Systems 35

Scotch-Brite™ Discs — Hook-and-Loop	35
Scotch-Brite™ Pads	36
3M™ Stikit™ Discs	36–39
3M™ PSA Discs	40
3M™ Power Tools	41–43
Accessories	44

Abrasive Belt Systems 45

3M™ Cubitron™ II Belts	45–46, 48–49
3M™ Trizact™ Abrasive Belts	47, 50–55
3M™ Belts	45–46, 56–62
Scotch-Brite™ Surface Conditioning Belts	63–65
3M™ Power Tools	66
Accessories	66–68

Portable Abrasive & Stationary Wheels 69

Scotch-Brite™ Convolute Wheels	69–73
Scotch-Brite™ Unitized Wheels	73–75
3M™ Flap Wheels	76–77
3M™ Power Tools	78
Accessories	79–80

Inline Sanding Systems 81

Weld Leveling Guide	81
Belts and Brushes	82
3M™ Power Tools	83
Accessories	84

Hand Finishing 85

3M™ Abrasive Sheets	85–87
Scotch-Brite™ Hand Pads	88–90
Scotch-Brite™ Rolls	91
Accessories	92

Specialty Abrasives 93

3M™ Cartridge Rolls	93
3M™ Square and Cross Pads	94
3M™ Bands	95
Scotch-Brite™ Specialty Abrasives	96–97
3M™ Power Tools	98
Accessories	99–100

Superabrasives 101

3M™ Wheels	102–108
3M™ Truing and Dressing Products	109–110

Adhesives and Tapes 111

Structural and Non-Structural Adhesives	111–118
Anaerobic Adhesives	119–120
3M™ Temporary Surface Protection Tapes	120–121
3M™ VHB™ Tapes	122
Masking Products	123–125
Filament Tapes and Dispensers	126–128
Specialty Tapes	128–129
Box Sealing Tapes and Dispensers	130–132
Duct Tapes	132

Safety Products 133

Respirators and Filters	133–136
3M™ Speedglas™ Welding Helmets	137–138
Hearing Conservation	139–141
Protective Eyewear	142
Sorbents	143
Fall Protection	144–145

SAFETY WARNINGS

146

Maintenance and Repair 147

3M™ Maintenance Aerosols	147
3M™ Electrical Products	147
3M™ Facility Care Products	148

Bonded Abrasives Systems



3M™ Bonded Wheels

Designed for your toughest grinding and cutting applications, 3M™ Grinding and Cut-Off Wheels are fast cutting and long lasting. Run with 3M™ Grinders or 3M™ Cut-Off Wheel Tools for optimal performance. For use on all metals. **DO NOT USE ON TOOLS WITHOUT GUARDS.**

3M™ Bonded Wheels Selection Guide

Bonded Wheel	Mineral	Type	Performance
3M™ Cubitron™ II	Precision Shaped Ceramic	T27	Premium
3M™ High Performance	Ceramic Abrasive Grain	T27	Best
3M™ Green Corps™	Ceramic Abrasive Grain	T27 and T28	Better
3M™ General Purpose	Aluminum Oxide	T27	Good

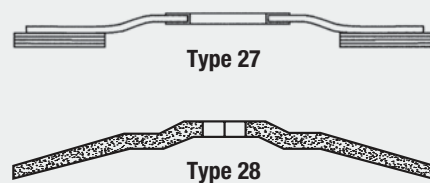

3M™ Cubitron™ II Depressed Center Grinding Wheel Type 27

- 3M precision-shaped grain for ultra fast cut and long life
- Cuts with less pressure
- Specially formulated for use on stainless and mild steel
- Cool cutting
- Available with quick change attachment
- **DO NOT USE ON TOOLS WITHOUT GUARDS**



UPC	Dia. x Thk. x AH	Max. RPM	Qty./Case
051115-66598-1	4" x 1/4" x 3/8"	15,300	10/20
051115-66597-4	4" x 1/4" x 5/8"	15,300	10/20
051115-66587-5	4-1/2" x 1/4" x 7/8"	13,300	10/20
051115-66588-2	5" x 1/4" x 7/8"	12,250	10/20
051115-66589-9	6" x 1/4" x 7/8"	10,200	10/20
051115-66590-5	7" x 1/4" x 7/8"	8,500	10/20
051115-66591-2	9" x 1/4" x 7/8"	6,650	10/20
Quick Change			
051115-66596-7	4-1/2" x 1/4" x 5/8-11	13,300	10/20
051115-66592-9	5" x 1/4" x 5/8-11	12,250	10/20
051115-66593-6	6" x 1/4" x 5/8-11	10,200	10/20
051115-66594-3	7" x 1/4" x 5/8-11	8,500	10/20
051115-66595-0	9" x 1/4" x 5/8-11	6,650	10/20

3M™ Depressed Center Grinding Wheels

3M™ High Performance Depressed Center Grinding Wheel Type 27

- A blend of conventional and precision-shaped grain provides fast cut and long life
- Cuts with less pressure
- Specially formulated for use on stainless and mild steel
- Available with quick change attachment
- **DO NOT USE ON TOOLS WITHOUT GUARDS**



UPC	Dia. x Thk. x AH	Max. RPM	Qty./Case
051115-66555-4	4" x 1/4" x 3/8"	15,300	10/20
051115-66554-7	4" x 1/4" x 5/8"	15,300	10/20
051115-66544-8	4-1/2" x 1/4" x 7/8"	13,300	10/20
051115-66545-5	5" x 1/4" x 7/8"	12,250	10/20
051115-66546-2	6" x 1/4" x 7/8"	10,200	10/20
051115-66547-9	7" x 1/4" x 7/8"	8,500	10/20
051115-66548-6	9" x 1/4" x 7/8"	6,650	10/20
Quick Change			
051115-66553-0	4-1/2" x 1/4" x 5/8-11	13,300	10/20
051115-66549-3	5" x 1/4" x 5/8-11	12,250	10/20
051115-66550-9	6" x 1/4" x 5/8-11	10,200	10/20
051115-66551-6	7" x 1/4" x 5/8-11	8,500	10/20
051115-66552-3	9" x 1/4" x 5/8-11	6,650	10/20

For safe applications using cut-off wheels, refer to ANSI B-7.1 for details. **ALWAYS** use appropriate wheel guards. Refer to ANSI B-186.1 for guarding requirements.

3M™ Depressed Center Grinding Wheels

3M™ Green Corps™ Type 27 Flexible Grinding Wheel

- 3M ceramic abrasive grain
- Can be used on a wide variety of metals
- Smooth running wheels produce less noise and vibration when grinding
- **DO NOT USE ON TOOLS WITHOUT GUARDS**



UPC	Dia. x Thk. x AH	Grade	Max. RPM	Qty./Case
051111-50440-6	4-1/2" x 1/8" x 7/8"	36	13,300	20/40
051111-50442-0	4-1/2" x 1/8" x 7/8"	46	13,300	20/40
051111-50443-7	4-1/2" x 1/8" x 7/8"	60	13,300	20/40
051111-50444-4	4-1/2" x 1/8" x 7/8"	80	13,300	20/40
051111-50445-1	7" x 1/8" x 7/8"	36	8,500	20/20
051111-50446-8	7" x 1/8" x 7/8"	46	8,500	20/20
051111-50447-5	7" x 1/8" x 7/8"	60	8,500	20/20

3M™ Green Corps™ Type 27 Depressed Center Wheel

- 3M ceramic abrasive grain
- Provides fast cut and long life
- Use with right angle grinders with a guard
- **DO NOT USE ON TOOLS WITHOUT GUARDS**

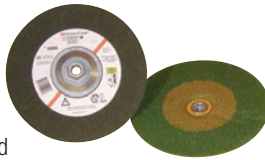

UPC	Dia. x Thk. x AH	Grade	Max. RPM	Qty./Case
051111-61010-7	4" x 1/4" x 3/8"	24	15,000	60
051111-55991-8	4-1/2" x 1/4" x 7/8"	24	13,300	40
051111-55992-5	4-1/2" x 1/4" x 7/8"	36	13,300	40
051111-55960-4	4-1/2" x 1/4" x 5/8-11 INT	24	13,300	40
051111-55961-1	4-1/2" x 1/4" x 5/8-11 INT	36	13,300	40
051111-55989-5	7" x 1/4" x 7/8"	24	8,500	20
051111-55990-1	7" x 1/4" x 7/8"	36	8,500	20
051111-55958-1	7" x 1/4" x 5/8-11 INT	24	8,500	20
051111-55959-8	7" x 1/4" x 5/8-11 INT	36	8,500	20
051111-55987-1	9" x 1/4" x 7/8"	24	6,600	20
051111-55956-7	9" x 1/4" x 5/8-11 INT	24	6,600	20

3M™ Green Corps™ Type 27 Cutting and Grinding Wheel

- 3M ceramic abrasive grain
- Safe to grind outer face and cut with edge of same wheel
- **DO NOT USE ON TOOLS WITHOUT GUARDS**

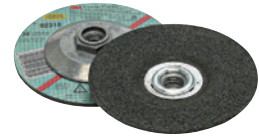

UPC	Dia. x Thk. x AH	Grade	Max. RPM	Qty./Case
051135-92316-0	4-1/2" x 1/8" x 7/8"	36	13,300	40
051135-92318-4	4-1/2" x 1/8" x 5/8-11 INT	36	13,300	40
051135-92317-7	7" x 1/8" x 7/8"	36	8,500	20
051135-92319-1	7" x 1/8" x 5/8-11 INT	36	8,500	20

3M™ Green Corps™ T-28 Depressed Center Wheel

- Made with 3M ceramic abrasive grain for fast cut rates and long life
- T28 shape works well when grinding at lower tool angles (15-25 degrees)
- Great for weld removal, grinding in tight areas and other MRO applications
- **DO NOT USE ON TOOLS WITHOUT GUARDS**



UPC	Dia. x Thk. x AH	Grade	Max. RPM	Qty./Case
051141-28327-2	7" x 1/4" x 5/8 INT	24	8,500	10

3M™ General Purpose Type 27 Wheel

- Aluminum oxide mineral
- Durable wheel provides exceptionally long life at a value price
- Excellent, economical choice for general purpose grinding on steel
- **DO NOT USE ON TOOLS WITHOUT GUARDS**

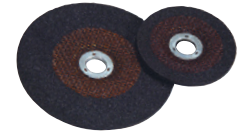

UPC	Dia. x Thk. x AH	Grade	Max. RPM	Qty./Case
051135-92312-2	4-1/2" x 1/4" x 7/8"	24	13,300	40
051135-92314-6	4-1/2" x 1/4" x 5/8-11 INT	24	13,300	40
051135-92313-9	7" x 1/4" x 7/8"	24	8,500	20
051135-92315-3	7" x 1/4" x 5/8-11 INT	24	8,500	20

3M™ Cubitron™ II Cut & Grind Wheels

If you're looking for a simple, effective way to boost shop productivity, new 3M™ Cubitron™ II Cut & Grind Wheels are the answer! These versatile bonded wheels are designed to be used both like a depressed center grinding wheel and as a cut-off wheel — making them ideal for cutting, grinding, gouging and more. **DO NOT USE ON TOOLS WITHOUT GUARDS.**

Optimized for use on mild steel and stainless steel, in applications including:

- Cutting
- Gouging
- Beveling
- Notching
- Fillet weld removal



3M™ Cut and Grind Wheels

3M™ Cubitron™ II Type 27 Cut & Grind Wheel

NEW!



- 3M precision-shaped grain for super fast cut and long life
- Versatile — can be used as both a grinding wheel and a cut-off wheel
- Optimized for use on mild steel and stainless steel — for cutting, gouging, beveling, notching and fillet weld removal
- Available with quick change attachment
- **DO NOT USE ON TOOLS WITHOUT GUARDS**

UPC	Dia. x Thk. x AH	Max. RPM	Qty./Case
046719-82276-8	4" x 1/8" x 3/8"	15,300	10/20
046719-82277-5	4" x 1/8" x 5/8"	15,300	10/20
046719-82278-2	5" x 1/8" x 7/8"	12,250	10/20
046719-82279-9	4-1/2" x 1/8" x 7/8"	13,300	10/20
051141-28758-4	6" x 1/8" x 7/8"	10,200	10/20
051141-28760-7	7" x 1/8" x 7/8"	8,500	10/20
051141-28761-4	9" x 1/8" x 7/8"	6,650	10/20
Quick Change			
051141-28762-1	4-1/2" x 1/8" x 5/8-11	13,300	10/20
051141-28763-8	5" x 1/8" x 5/8-11	12,250	10/20
051141-28764-5	6" x 1/8" x 5/8-11	10,200	10/20
051141-28765-2	7" x 1/8" x 5/8-11	8,500	10/20
051141-28766-9	9" x 1/8" x 5/8-11	6,650	10/20



For safe applications using cut-off wheels, refer to ANSI B-7.1 for details. **ALWAYS** use appropriate wheel guards. Refer to ANSI B-186.1 for guarding requirements.

3M™ Cut-Off Wheels

Durable and fast-cutting wheels for your toughest cutting applications. Run with 3M™ Cut-Off Wheel Tools for optimal performance. For use on all metals.

3M™ Cut-Off Wheels Selection Guide

Product	Mineral	Type	Performance
3M™ Cubitron™ II	Precision Shaped Ceramic	T1	Premium
		T27	Premium
3M™ High Performance	Ceramic Abrasive Grain	T1	Best
		T27	Best
3M™ Green Corps™	Ceramic Abrasive Grain	T1	Better
3M™ General Purpose	Aluminum Oxide	T1	Good

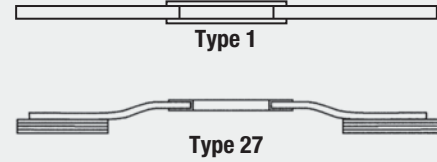

3M™ Cut-Off Wheels

3M™ Cubitron™ II Cut-Off Wheel Type 1

NEW!



- Premium performance
- 3M precision-shaped grain for ultra-fast cool cutting action and long life
- Cuts with less pressure
- Cool cutting
- Specially formulated for use on stainless and mild steel

UPC	Dia. x Thk. x AH	Max. RPM	Qty./Case
051115-66513-4	3" x .035" x 1/4"	25,465	25/50
051115-66514-1	3" x .035" x 3/8"	25,465	25/50
051115-66515-8	3" x .06" x 1/4"	25,465	25/50
051115-66516-5	3" x .06" x 3/8"	25,465	25/50
051115-66517-2	4" x .035" x 1/4"	19,100	25/50
051115-66518-9	4" x .035" x 3/8"	19,100	25/50
051115-66519-6	4" x .035" x 5/8"	15,300	25/50
051115-66520-2	4" x .06" x 3/8"	19,100	25/50
051115-66521-9	4" x .09" x 5/8"	15,300	25/50
051115-66522-6	4" x .045" x 5/8"	15,300	25/50
051115-66523-3	4" x .06" x 5/8"	15,300	25/50
051115-66524-0	4" x .125" x 3/8"	19,100	25/50
051115-66525-7	4-1/2" x .045" x 7/8"	13,300	25/50
051115-66526-4	5" x .045" x 7/8"	12,250	25/50
051115-66527-1	6" x .045" x 7/8"	10,200	25/50
051115-66528-8	7" x .045" x 7/8"	8,500	25/50

3M™ Cubitron™ II Cut-Off Wheel Type 27

NEW!



- Premium performance
- 3M precision-shaped grain for ultra-fast cool cutting action and long life
- Cuts with less pressure
- Specially formulated for use on stainless and mild steel
- Available with quick change attachment

UPC	Dia. x Thk. x AH	Max. RPM	Qty./Case
051115-66529-5	4" x .045" x 5/8"	15,300	25/50
051115-66531-8	4-1/2" x .045" x 7/8"	13,300	25/50
051115-66533-2	4-1/2" x .09" x 7/8"	13,300	25/50
051115-66535-6	4-1/2" x .125" x 7/8"	13,300	25/50
051115-66537-0	5" x .045" x 7/8"	12,250	25/50
051115-66539-4	5" x .09" x 7/8"	12,250	25/50
051115-66541-7	6" x .045" x 7/8"	10,200	25/50
051115-66543-1	7" x .09" x 7/8"	8,500	25/50

Quick Change

051115-66530-1	4-1/2" x .045" x 5/8-11	13,300	25/50
051115-66532-5	4-1/2" x .09" x 5/8-11	13,300	25/50
051115-66534-9	4-1/2" x .125" x 5/8-11	13,300	25/50
051115-66536-3	5" x .045" x 5/8-11	12,250	25/50
051115-66538-7	5" x .09" x 5/8-11	12,250	25/50
051115-66540-0	6" x .045" x 5/8-11	10,200	25/50
051115-66542-4	7" x .09" x 5/8-11	8,500	25/50

For safe applications using cut-off wheels, refer to ANSI B-7.1 for details. **ALWAYS** use appropriate wheel guards. Refer to ANSI B-186.1 for guarding requirements.

3M™ Cut-Off Wheels

3M™ High Performance Cut-Off Wheel Type 1

NEW!

- A blend of 3M precision-shaped ceramic grain and conventional abrasive grain provides fast cut and long life
- Specially formulated for use on stainless and mild steel

UPC	Dia. x Thk. x AH	Max. RPM	Qty./Case
051115-66556-1	3" x .035" x 1/4"	25,465	25/50
051115-66557-8	3" x .035" x 3/8"	25,465	25/50
051115-66558-5	3" x .06" x 1/4"	25,465	25/50
051115-66559-2	3" x .06" x 3/8"	25,465	25/50
051115-66560-8	4" x .035" x 1/4"	19,100	25/50
051115-66561-5	4" x .035" x 3/8"	19,100	25/50
051115-66562-2	4" x .035" x 5/8"	15,300	25/50
051115-66563-9	4" x .06" x 3/8"	19,100	25/50
051115-66564-6	4" x .09" x 5/8"	15,300	25/50
051115-66565-3	4" x .045" x 5/8"	15,300	25/50
051115-66566-0	4" x .06" x 5/8"	15,300	25/50
051115-66567-7	4" x .125" x 3/8"	19,100	25/50
051115-66568-4	4-1/2" x .045" x 7/8"	13,300	25/50
051115-66569-1	5" x .045" x 7/8"	12,250	25/50
051115-66570-7	6" x .045" x 7/8"	10,200	25/50
051115-66571-4	7" x .045" x 7/8"	8,500	25/50

3M™ High Performance Cut-Off Wheel Type 27

NEW!

- A blend of 3M precision-shaped ceramic grain and conventional abrasive grain provides fast cut and long life
- Specially formulated for use on stainless and mild steel

UPC	Dia. x Thk. x AH	Max. RPM	Qty./Case
051115-66572-1	4" x .045" x 5/8"	15,300	25/50
051115-66574-5	4-1/2" x .045" x 7/8"	13,300	25/50
051115-66576-9	4-1/2" x .09" x 7/8"	13,300	25/50
051115-66578-3	4-1/2" x .125" x 7/8"	13,300	25/50
051115-66580-6	5" x .045" x 7/8"	12,250	25/50
051115-66582-0	5" x .09" x 7/8"	12,250	25/50
051115-66584-4	6" x .045" x 7/8"	10,200	25/50
051115-66586-8	7" x .09" x 7/8"	8,500	25/50
Quick Change			
051115-66573-8	4-1/2" x .045" x 5/8-11	13,300	25/50
051115-66575-2	4-1/2" x .09" x 5/8-11	13,300	25/50
051115-66577-6	4-1/2" x .125" x 5/8-11	13,300	25/50
051115-66579-0	5" x .045" x 5/8-11	12,250	25/50
051115-66581-3	5" x .09" x 5/8-11	12,250	25/50
051115-66583-7	6" x .045" x 5/8-11	10,200	25/50
051115-66585-1	7" x .09" x 5/8-11	8,500	25/50

3M™ Green Corps™ Cut-Off Wheels



- 3M ceramic abrasive grain
- Provides high cut rates and long life on various substrates, including fiberglass, stainless steel and carbon steel
- Must be used with ANSI-approved flanges for Type 1 cut-off wheels
- **DO NOT USE ON TOOLS WITHOUT GUARDS**

UPC	Dia. x W x AH	Max. RPM	Min./Case
051144-83487-7	2" x 1/16" x 1/4"	42,000	50/50
051144-82238-6	3" x 1/32" x 1/4"	35,000	50/50
051131-01989-8	3" x 1/32" x 3/8"	35,000	5 wheels/pack 10 packs/case
051131-01985-0	3" x 1/32" x 3/8"	35,000	50/50
051131-01990-4	3" x 1/16" x 3/8"	28,000	5 wheels/pack 10 packs/case
051131-01986-7	3" x 1/16" x 3/8"	28,000	50/50
051144-83488-4	4" x 1/16" x 3/8"	21,000	50/50
051144-88755-2	4" x 1/32" x 1/4"	26,250	50/50
051131-01994-2	4" x 1/32" x 3/8"	26,250	50/50
051141-20275-4	4-1/2" x 3/64" x 7/8"	13,300	50/200
051141-20276-1	4-5/64" x 3/64" x 7/8"	12,200	50/200

3M™ General Purpose Cut-Off Wheels

- Value priced wheel provides fast cut and long life
- Best on carbon steel
- Must be used with ANSI-approved flanges for Type 1 cut-off wheels
- **DO NOT USE ON TOOLS WITHOUT GUARDS**



UPC	Dia. x W x AH	Max. RPM	Min./Case
051141-20447-5	6" x .045" x 7/8"	10,200	50/100
051141-20448-2	4" x 1/32" x 3/8"	21,000	50/100
051141-20449-9	4" x 1/16" x 3/8"	21,000	50/100

For safe applications using cut-off wheels, refer to ANSI B-7.1 for details. **ALWAYS** use appropriate wheel guards. Refer to ANSI B-186.1 for guarding requirements.

3M™ Power Tools for Bonded Abrasives

3M™ Grinders — Type 27

- Powerful and lightweight for more comfortable grinding and improved productivity
- Built for durability and smooth operation
- 3M™ Gripping Material for added comfort and reduced vibration
- Features repositionable guards for better visibility, steel gear heads for added durability and superior noise reduction



Model No.	Tool Dia. Inch (mm)	Motor HP (W)	Max RPM	Weight Pound (kg)	Length	Height Inch (mm)	Air Inlet Thread	Airflow Rate SCFM (LPM)	Thread Size	UPC
28403	4 (100)	1 (744)	12,000	2.66 (1.21)	Standard	4.5 (114)	3/8" NPT*	37 (1,048)	3/8"-24 EXT	051141-28403-3
28413	4 (100)	1 (744)	12,000	3.85 (1.75)	Extended	4.5 (114)	3/8" NPT*	37 (1,048)	3/8"-24 EXT	051141-28413-2
28405	4-1/2 (114.3)	1 (744)	12,000	2.84 (1.29)	Standard	4.7 (119)	3/8" NPT*	37 (1,048)	5/8"-11 EXT	051141-28405-7
28414	4-1/2 (114.3)	1 (744)	12,000	4.03 (1.83)	Extended	4.7 (119)	3/8" NPT*	37 (1,048)	5/8"-11 EXT	051141-28414-9

*Includes 3/8" to 1/4" reducer

3M™ Cut-Off Wheel Tools

- Right angle head and repositionable guard for optimal power and visibility
- Extended body style for greater versatility and control
- 3M™ Gripping Material for added comfort and reduced vibration



Model No.	Tool Dia. Inch (mm)	Motor HP (W)	Max RPM	Weight Pound (kg)	Length Inch (mm)	Height Inch (mm)	Air Inlet Thread	Airflow Rate SCFM (LPM)	UPC
NEW! 28771†	4 (100)	1 (744)	19,000	2.25 (1.02)	Standard	3 (83)	3/8" NPT	37 (1,048)	051141-28771-3
28407	4 (100)	1 (744)	18,000	2.25 (1.02)	Extended	4.26 (108.2)	3/8" NPT*	37 (1,048)	051141-28407-1

† Replaced Model No. 20243

*Includes 3/8" to 1/4" reducer





Optional Grinder Guard

- Allows 4" grinder to run larger, thicker 4-1/2" fibre and flap discs
- Both guards (55106 and 28632) fit all 1 HP 3M™ Right Angle Grinders and Disc Sanders



Model No.	Size	For Use With Tool	Required Accessories	UPC
55106	4-1/2"	3M™ Grinders — 4" (Model No. 28403; 28413)	Accessories with 3/8"-24 INT threads	051141-29403-3
28632	5"	3M™ Disc Sanders, 1 HP — 4"-5" (Model No. 28408)	Accessories with 5/8"-11 INT threads	051141-28632-7

Accessories for 3M™ Bonded Wheels and Cut-Off Wheels

Product Name	UPC	Size/Description	For Use With	Qty./Case
Grinding Wheel Adapter Nut 	051144-88765-1	5/8-11 Thread	Secures 4-1/2" diameter grinding wheels to right angle tool with a 5/8-11 threaded shaft	1 Pair/5 Pairs
Flap Disc Holder 	051144-88769-9	4" Diameter; 5/8-11 Thread	Holder for 7"-9" diameter Type 27 grinding wheels	1
3M™ Green Corps™ Flexible Grinding Disc 	051111-51046	3-3/8" Diameter; 7/8" Center Hole; Clear	Holder for 4-1/2" x 7/8" center hole flexible grinding wheel	5/100
	051111-51045	4-5/8" Diameter; 7/8" Center Hole; Clear	Holder for 7" x 7/8" center hole flexible grinding wheel	5/100
Flange Nut 	051141-28739-3	1" x 5/8" x 3/8"; 3/8-24 INT	4" grinder with 3/8-24 thread; 4" x 1/4" x 5/8" center hole Depressed Center Grinding Wheels and Unitized Wheels	1 Set
	051141-28740-9	1" x 5/8"; 5/8-11 INT	4-1/2" grinder with 5/8-11 thread; 4" x 1/4" x 5/8" center hole Depressed Center Grinding Wheels and Unitized Wheels	1 Set

3M™ Right Angle Disc Systems — Fibre, Flap and Scotch-Brite™ Discs



3M™ Fibre Discs

Choose the performance level that fits your needs with a complete offering of 3M™ Fibre Discs. Get great performance at a great price with the general purpose metalworking 3M™ Fibre Disc 381C. Or, set a new standard for productivity with 3M™ Cubitron™ II 982C Discs. All of 3M's fibre discs are available in a variety of sizes.

Selection Guide for Carbon Steel

For fast cutting when grinding and blending carbon steel.

Product	Mineral Type	Performance
3M™ Fibre Disc 381C	Aluminum Oxide	Good
3M™ Fibre Disc 501C	Alumina Zirconia	Better
3M™ Fibre Disc 988C	Ceramic Abrasive Grain	Better
3M™ Cubitron™ II Fibre Disc 982C	Precision Shaped Ceramic	Best

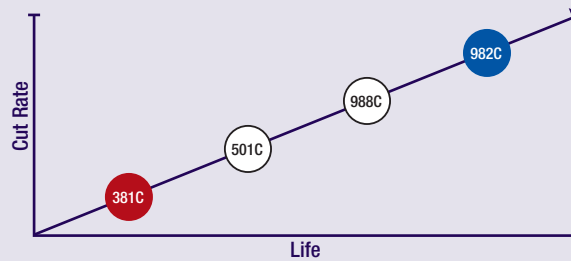

Selection Guide for Stainless Steel or Aluminum

For fast cutting when grinding and blending stainless steel or aluminum.

Product	Mineral Type	Performance
3M™ Fibre Disc 501C	Alumina Zirconia	Good
3M™ Fibre Disc 785C	Ceramic Aluminum Oxide Blend	Better
3M™ Fibre Disc 985C	Ceramic Abrasive Grain	Better
3M™ Cubitron™ II Fibre Disc 987C	Precision Shaped Ceramic	Best

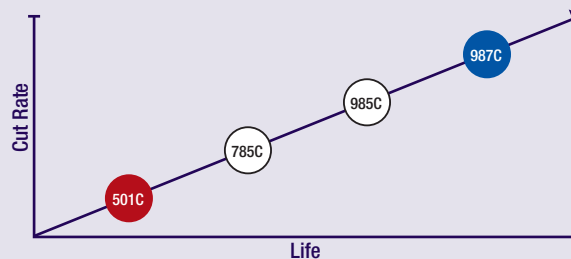

3M™ Fibre Discs

3M™ Cubitron™ II Fibre Disc 982C

- 3M precision shaped ceramic grain, engineered with ultra-sharp, fast cutting points that wear evenly, run cool, and optimize mineral breakdown to maximize life
- Best in class for weld prep and removal on carbon steel applications



UPC	Dia. x Ctr. Hole	Grade	Max. RPM	Min./Case
051141-27400-3	4-1/2" x 7/8"	36+	13,300	25/100
051141-27631-1	4-1/2" x 7/8"	60+	13,300	25/100
051141-27635-9	4-1/2" x 7/8"	80+	13,300	25/100
051141-27401-0	5" x 7/8"	36+	12,000	25/100
051141-27632-8	5" x 7/8"	60+	12,000	25/100
051141-27636-6	5" x 7/8"	80+	12,000	25/100
051141-27402-7	7" x 7/8"	36+	8,600	25/100
051141-27633-5	7" x 7/8"	60+	8,600	25/100
051141-27637-3	7" x 7/8"	80+	8,600	25/100
051141-27403-4	9-1/8" x 7/8"	36+	6,600	25/100
051141-27634-2	9-1/8" x 7/8"	60+	6,600	25/100
051141-27638-0	9-1/8" x 7/8"	80+	6,600	25/100

TN Quick Change

051141-27425-6	4-1/2" x 5/8-11*	36+	13,300	25/100
051141-27639-7	4-1/2" x 5/8-11*	60+	13,300	25/100
051141-27642-7	4-1/2" x 5/8-11*	80+	13,300	25/100
051141-27404-1	5" x 5/8-11*	36+	12,000	25/100
051141-27640-3	5" x 5/8-11*	60+	12,000	25/100
051141-27643-4	5" x 5/8-11*	80+	12,000	25/100
051141-27405-8	7" x 5/8-11*	36+	8,600	25/100
051141-27641-0	7" x 5/8-11*	60+	8,600	25/100
051141-27644-1	7" x 5/8-11*	80+	8,600	25/100

GL Quick Change

051141-27406-5	5" x 5/8-11*	36+	12,000	25/100
051141-27724-0	5" x 5/8-11*	60+	12,000	25/100
051141-27726-4	5" x 5/8-11*	80+	12,000	25/100
051141-27407-2	7" x 5/8-11*	36+	8,600	25/100
051141-27725-7	7" x 5/8-11*	60+	8,600	25/100
051141-27727-1	7" x 5/8-11*	80+	8,600	25/100

* Quick Change Tinneman Nut Attachment



3M™ Cubitron™ II Fibre Disc 987C

- 3M precision shaped grain technology, engineered with ultra-sharp, fast cutting points that wear evenly, run cool, and optimize mineral breakdown to maximize life
- Best in class for weld prep and removal on heat sensitive alloys such as stainless steel



UPC	Dia. x Ctr. Hole	Grade	Max. RPM	Min./Case
051141-27447-8	4-1/2" x 7/8"	36+	13,300	25/100
051141-27653-3	4-1/2" x 7/8"	60+	13,300	25/100
051141-27657-1	4-1/2" x 7/8"	80+	13,300	25/100
051141-27448-5	5" x 7/8"	36+	12,000	25/100
051141-27654-0	5" x 7/8"	60+	12,000	25/100
051141-27658-8	5" x 7/8"	80+	12,000	25/100
051141-27449-2	7" x 7/8"	36+	8,600	25/100
051141-27655-7	7" x 7/8"	60+	8,600	25/100
051141-27659-5	7" x 7/8"	80+	8,600	25/100
051141-27450-8	9-1/8" x 7/8"	36+	6,600	25/100
051141-27656-4	9-1/8" x 7/8"	60+	6,600	25/100
051141-27660-1	9-1/8" x 7/8"	80+	6,600	25/100

TN Quick Change

051141-27469-0	4-1/2"	36+	13,300	25/100
051141-27661-8	4-1/2"	60+	13,300	25/100
051141-27664-9	4-1/2"	80+	13,300	25/100
051141-27467-6	5"	36+	12,000	25/100
051141-27662-5	5"	60+	12,000	25/100
051141-27665-6	5"	80+	12,000	25/100
051141-27468-3	7"	36+	8,600	25/100
051141-27663-2	7"	60+	8,600	25/100
051141-27666-3	7"	80+	8,600	25/100

GL Quick Change

051141-27728-8	5"	36+	12,000	25/100
051141-27730-1	5"	60+	12,000	25/100
051141-27732-5	5"	80+	12,000	25/100
051141-27729-5	7"	36+	8,600	25/100
051141-27731-8	7"	60+	8,600	25/100
051141-27733-2	7"	80+	8,600	25/100

Tech Tip

Weld Blending Mild Steel for Paint Prep

Step 1 – Fibre Disc 982C Grade 36+

Step 2 – Scotch-Brite™ Light Grinding and Blending Disc SD on black ribbed pad

Step 3 – Apply 3 mil Paint

Results – Increase productivity
– Reduce abrasive cost

3M™ Fibre Discs

3M™ Fibre Discs 381C

- General purpose disc for weld removal, grinding and blending
- Resin bond aluminum oxide provides durability and aggressive stock removal



UPC	Dia. x Ctr. Hole	Grade	Max. RPM	Min./Case
051144-77595-8	4-1/2" x 7/8"	24	13,300	25
051144-77596-5	4-1/2" x 7/8"	36	13,300	25
051144-77597-2	4-1/2" x 7/8"	50	13,300	25
051144-77598-9	4-1/2" x 7/8"	60	13,300	25
051144-77599-6	4-1/2" x 7/8"	80	13,300	25
051144-77600-9	4-1/2" x 7/8"	100	13,300	25
051144-77601-6	4-1/2" x 7/8"	120	13,300	25
051144-81369-8	5" x 7/8"	24	12,000	25
051144-81372-8	5" x 7/8"	36	12,000	25
051144-81375-9	5" x 7/8"	50	12,000	25
051144-01727-0	5" x 7/8"	60	12,000	25
051144-20054-2	5" x 7/8"	80	12,000	25
051144-20053-5	5" x 7/8"	100	12,000	25
051144-20052-8	5" x 7/8"	120	12,000	25
051144-01745-4	7" x 7/8"	16	8,600	25
051144-81370-4	7" x 7/8"	24	8,600	25
051144-81373-5	7" x 7/8"	36	8,600	25
051144-81376-6	7" x 7/8"	50	8,600	25
051144-01741-6	7" x 7/8"	60	8,600	25
051144-01740-9	7" x 7/8"	80	8,600	25
051144-01739-3	7" x 7/8"	100	8,600	25
051144-01738-6	7" x 7/8"	120	8,600	25
051144-81371-1	9-1/8" x 7/8"	24	6,600	25/100
051144-81373-5	9-1/8" x 7/8"	36	6,600	25/100
051144-81377-3	9-1/8" x 7/8"	50	6,600	25
051144-01762-1	9-1/8" x 7/8"	80	6,600	25
051144-01761-4†	9-1/8" x 7/8"	100	6,600	25
051144-01760-7†	9-1/8" x 7/8"	120	6,600	25

† Made-to-Order

3M™ Fibre Discs 501C

- Versatile disc for use on a wide variety of metals
- Aluminum zirconia provides a good option for both stainless and mild steel applications



UPC	Dia. x Ctr. Hole	Grade	Max. RPM	Min./Case
051111-50409-3	4-1/2" x 7/8"	24	13,300	25/100
051111-50413-0	4-1/2" x 7/8"	36	13,300	25/100
051111-50414-7	4-1/2" x 7/8"	50	13,300	25/100
051111-50415-4	4-1/2" x 7/8"	60	13,300	25/100
051111-50416-1	4-1/2" x 7/8"	80	13,300	25/100
051111-50417-8	4-1/2" x 7/8"	100	13,300	25/100
051111-50419-2	4-1/2" x 7/8"	120	13,300	25/100
051111-50410-9	5" x 7/8"	24	12,000	25/100
051111-50412-3	5" x 7/8"	36	12,000	25/100
051111-50420-8	5" x 7/8"	50	12,000	25/100
051111-50421-5	5" x 7/8"	60	12,000	25/100
051111-50422-2	5" x 7/8"	80	12,000	25/100
051111-50423-9	5" x 7/8"	100	12,000	25/100
051111-50424-6	5" x 7/8"	120	12,000	25/100
051111-50411-6	7" x 7/8"	24	8,600	25/100
051111-50426-0	7" x 7/8"	36	8,600	25/100
051111-50425-3	7" x 7/8"	50	8,600	25/100
051111-50427-7	7" x 7/8"	60	8,600	25/100
051111-50428-4	7" x 7/8"	80	8,600	25/100
051125-63799-2†	7" x 7/8"	100	8,600	25/100
051111-50430-7†	7" x 7/8"	120	8,600	25/100
051111-50432-1†	9-1/8" x 7/8"	24	6,600	25/100
051111-50433-8	9-1/8" x 7/8"	36	6,600	25/100
051111-50434-5†	9-1/8" x 7/8"	50	6,600	25/100

† Made-to-Order



3M™ Fibre Discs

3M™ Fibre Discs 785C

- 3M ceramic aluminum oxide blend abrasive grain
- An excellent starting point for stainless steel
- Includes a grinding aid for cooler running

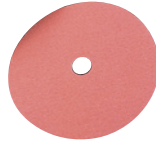

UPC	Dia. x Ctr. Hole	Grade	Max. RPM	Min./Case
051111-60719-0	4-1/2" x 5/8-11*	36	13,300	25
051144-80660-7	4-1/2" x 7/8"	36	13,300	25/100
051144-80661-4	4-1/2" x 7/8"	50	13,300	25/100
051144-80662-1	4-1/2" x 7/8"	60	13,300	25/100
051144-80663-8	4-1/2" x 7/8"	80	13,300	25/100
051144-80665-2	4-1/2" x 7/8"	P120	13,300	25/100
051144-13931-6	5" x 7/8"	24	12,000	25/100
051144-13930-9	5" x 7/8"	36	12,000	25/100
051144-13928-6	5" x 7/8"	50	12,000	25/100
051144-13977-4	5" x 7/8"	60	12,000	25/100
051144-13926-2	5" x 7/8"	80	12,000	25/100
051144-80654-6	5" x 7/8"	P100	12,000	25/100
051144-80655-3	5" x 7/8"	P120	12,000	25/100
051144-88831-3†	7" x 5/8-11*	60	8,600	25/100
051144-13937-8	7" x 7/8"	24	8,600	25/100
051144-13936-1	7" x 7/8"	36	8,600	25/100
051144-13934-7	7" x 7/8"	50	8,600	25/100
051144-13933-0	7" x 7/8"	60	8,600	25/100
051144-13932-3	7" x 7/8"	80	8,600	25/100
051144-80656-0	7" x 7/8"	P100	8,600	25/100
051144-80657-7	7" x 7/8"	P120	8,600	25/100
051144-13943-9	9-1/8" x 7/8"	24	6,600	25/100
051144-13942-2	9-1/8" x 7/8"	36	6,600	25/100
051144-13940-8	9-1/8" x 7/8"	50	6,600	25/100
051144-13938-5	9-1/8" x 7/8"	80	6,600	25/100

† Made-to-Order

* Quick Change Tinneman Nut Attachment

3M™ Fibre Discs 985C

- 3M ceramic abrasive grain
- 3M's better choice for a long-lasting, premium disc for stainless steel
- Includes a grinding aid for cooler running



UPC	Dia. x Ctr. Hole	Grade	Max. RPM	Min./Case
051111-55767-9	5" x 7/8"	36	12,000	25/100
051111-55780-8	5" x 7/8"	50	12,000	25/100
051111-55776-1	5" x 7/8"	60	12,000	25/100
051111-55779-2	5" x 7/8"	80	12,000	25/100
051111-55971-0	7" x 7/8"	24	8,600	25/100
051111-55972-7	7" x 7/8"	36	8,600	25/100
051111-55973-4	7" x 7/8"	50	8,600	25/100
051111-55974-1	7" x 7/8"	60	8,600	25/100
051111-55975-8	7" x 7/8"	80	8,600	25/100

3M™ Fibre Discs 988C

- 3M ceramic abrasive grain
- 3M's best premium disc for long-lasting performance for mild steel grinding



UPC	Dia. x Ctr. Hole	Grade	Max. RPM	Min./Case
051111-55712-9	4-1/2" x 5/8-11*	36	13,300	25/100
051141-27341-9†	5" x 5/8-11*	36	12,000	100
051111-55746-4	5" x 7/8"	24	12,000	25/100
051111-55743-3	5" x 7/8"	36	12,000	25/100
051111-55742-6	5" x 7/8"	50	12,000	25/100
051111-60319-2	5" x 7/8"	60	12,000	25/100
051111-55740-2	5" x 7/8"	80	12,000	25/100
051111-55840-9	7" x 5/8-11*	24	8,600	25/100
051111-55715-0	7" x 5/8-11*	36	8,600	25/100
051111-55964-2	7" x 7/8"	24	8,600	25/100
051111-55965-9	7" x 7/8"	36	8,600	25/100
051111-55966-6	7" x 7/8"	40	8,600	25/100
051111-55967-3	7" x 7/8"	50	8,600	25/100
051111-55739-6	7" x 7/8"	60	8,600	25/100
051111-55968-0	7" x 7/8"	80	8,600	25/100
051111-60314-7	7" x 7/8"	24	8,600	50/100
051111-55744-0	9-1/8" x 7/8"	24	6,600	25/100
051111-55735-8	9-1/8" x 7/8"	36	6,600	25/100
051111-55733-4	9-1/8" x 7/8"	50	6,600	25/100

† Made-to-Order

* Quick Change Tinneman Nut Attachment



Tech Tip

Use 3M™ Red Ribbed Pads to optimize product life of 900 series fibre discs — grades 24 and 36.

3M™ Flap Discs

3M™ Flap Discs offer an unbeatable system for grinding and blending in one easy step. The construction wears away, exposing fresh mineral to extend disc life and provide consistent cut rates. Great for weld grinding, blending, deburring, rust removal, surface prep and edge grinding on all types of metals. Available in both T29 or T27 constructions with or without the 5/8–11 hub.

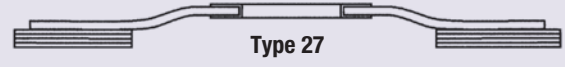
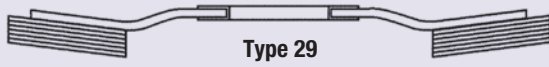

3M™ Flap Disc Selection Guide

Select Flap Discs for extended life and single-step grinding/blending on all types of metals.

Product	Mineral Type	Performance	4-1/2" x 7/8"		4-1/2" x 5/8-11		7" x 7/8"		7" x 5/8-11	
			T27	T29	T27	T29	T27	T29	T27	T29
3M™ Flap Disc 546D	Alumina Zirconia	Good	■	■	■	■	■	■	■	■
3M™ Flap Disc 577F	Alumina Zirconia	Good	■	■	■	■	■	■	■	■
3M™ Flap Disc 566A	Alumina Zirconia	Good	■	■	■	■	■	■	■	■
3M™ Cubitron™ II Flap Disc 967A	Precision-Shaped Ceramic	Best	■	■	■	■	■	■	■	■

Performance Under Pressure — Choose the right disc for the job.

High Pressure: Beveling, Deburring

Medium Pressure: Weld Removal, Scale Removal, Oxide Removal, Surface Prep

Low Pressure: Blending, Light Cleaning

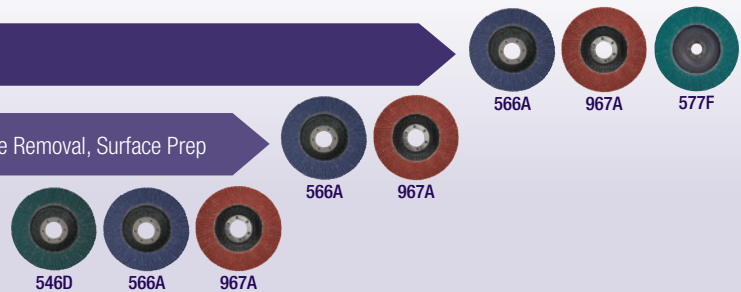

3M™ Flap Discs

3M™ Cubitron™ II Flap Discs 967A

- Made with revolutionary 3M precision-shaped grain technology
- Grinds and blends in a single step
- Flexible to follow curves and contours
- Long-life and consistency at any grinding pressure



UPC	Dia. x Ctr. Hole	Grade	Max. RPM	Qty./Case
Type 27				
051141-55602-4	4-1/2" x 5/8-11*	40+	13,300	10
051141-55603-1	4-1/2" x 5/8-11*	60+	13,300	10
051141-55604-8	4-1/2" x 5/8-11*	80+	13,300	10
051141-55605-5	4-1/2" x 7/8"	40+	13,300	10
051141-55606-2	4-1/2" x 7/8"	60+	13,300	10
051141-55607-9	4-1/2" x 7/8"	80+	13,300	10
051141-55608-6	7" x 5/8-11*	40+	8,600	5
051141-55609-3	7" x 5/8-11*	60+	8,600	5
051141-55610-9	7" x 5/8-11*	80+	8,600	5
051141-55611-6	7" x 7/8"	40+	8,600	5
051141-55612-3	7" x 7/8"	60+	8,600	5
051141-55613-0	7" x 7/8"	80+	8,600	5

* Quick Change Hub Attachment

3M™ Cubitron™ II Flap Discs 967A (cont.)

UPC	Dia. x Ctr. Hole	Grade	Max. RPM	Qty./Case
Type 29				
051141-55620-8	4-1/2" x 5/8-11*	40+	13,300	10
051141-55621-5	4-1/2" x 5/8-11*	60+	13,300	10
051141-55622-2	4-1/2" x 5/8-11*	80+	13,300	10
051141-55623-9	4-1/2" x 7/8"	40+	13,300	10
051141-55624-6	4-1/2" x 7/8"	60+	13,300	10
051141-55625-3	4-1/2" x 7/8"	80+	13,300	10
051141-55626-0	7" x 5/8-11*	40+	8,600	5
051141-55627-7	7" x 5/8-11*	60+	8,600	5
051141-55628-4	7" x 5/8-11*	80+	8,600	5
051141-55629-1	7" x 7/8"	40+	8,600	5
051141-55630-7	7" x 7/8"	60+	8,600	5
051141-55631-4	7" x 7/8"	80+	8,600	5

* Quick Change Hub Attachment

3M™ Flap Discs

3M™ Flap Discs 546D

- Versatile alumina zirconia mineral works on a variety of metals and applications
- Flexible X wt. cotton backing designed for fast cut on light duty grinding/finishing applications

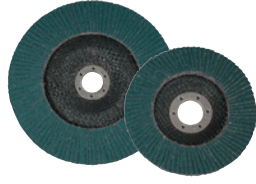

UPC	Dia. x Ctr. Hole	Grade	Max. RPM	Qty./Case
Type 29				
051115-28874-6†	4-1/2" x 7/8"	24	13,300	10
051115-28875-3†	4-1/2" x 7/8"	36	13,300	10
051115-28876-0	4-1/2" x 7/8"	40	13,300	10
051115-28877-7	4-1/2" x 7/8"	60	13,300	10
051115-28878-4	4-1/2" x 7/8"	80	13,300	10
051115-28879-1†	4-1/2" x 7/8"	120	13,300	10
051115-28868-5†	4-1/2" x 5/8-11*	24	13,300	10
051115-28869-2†	4-1/2" x 5/8-11*	36	13,300	10
051115-28870-8	4-1/2" x 5/8-11*	40	13,300	10
051115-28871-5	4-1/2" x 5/8-11*	60	13,300	10
051115-28872-2	4-1/2" x 5/8-11*	80	13,300	10
051115-28873-9†	4-1/2" x 5/8-11*	120	13,300	10
051115-28926-2†	7" x 7/8"	24	8,600	5
051115-28927-9†	7" x 7/8"	36	8,600	5
051115-28928-6	7" x 7/8"	40	8,600	5
051115-28929-3	7" x 7/8"	60	8,600	5
051115-28930-9	7" x 7/8"	80	8,600	5
051115-28931-6†	7" x 7/8"	120	8,600	5
051115-28920-0†	7" x 5/8-11*	24	8,600	5
051115-28921-7†	7" x 5/8-11*	36	8,600	5
051115-28922-4	7" x 5/8-11*	40	8,600	5
051115-28923-1	7" x 5/8-11*	60	8,600	5
051115-28924-8	7" x 5/8-11*	80	8,600	5
051115-28925-5†	7" x 5/8-11*	120	8,600	5

† Made-to-Order

* Quick Change Hub Attachment

3M™ Flap Discs 546D (cont.)

UPC	Dia. x Ctr. Hole	Grade	Max. RPM	Qty./Case
Type 27				
051141-30598-1†	4-1/2" x 7/8"	36	13,300	10
051141-30599-8	4-1/2" x 7/8"	40	13,300	10
051141-30600-1	4-1/2" x 7/8"	60	13,300	10
051141-30601-8	4-1/2" x 7/8"	80	13,300	10
051141-30602-5†	4-1/2" x 7/8"	120	13,300	10
051141-30593-6†	4-1/2" x 5/8-11*	36	13,300	10
051141-30594-3	4-1/2" x 5/8-11*	40	13,300	10
051141-30595-0	4-1/2" x 5/8-11*	60	13,300	10
051141-30596-7	4-1/2" x 5/8-11*	80	13,300	10
051141-30597-4†	4-1/2" x 5/8-11*	120	13,300	10
051141-30603-2†	7" x 7/8"	36	8,600	5
051141-30604-9	7" x 7/8"	40	8,600	5
051141-30605-6	7" x 7/8"	60	8,600	5
051141-30606-3	7" x 7/8"	80	8,600	5
051115-28917-0†	7" x 7/8"	120	8,600	5
051141-30607-0†	7" x 5/8-11*	36	8,600	5
051141-30608-7	7" x 5/8-11*	40	8,600	5
051141-30609-4	7" x 5/8-11*	60	8,600	5
051141-30610-0	7" x 5/8-11*	80	8,600	5
051115-28919-4†	7" x 5/8-11*	120	8,600	5

† Made-to-Order

* Quick Change Hub Attachment



Tech Tip

Flap discs typically provide a finish one grade finer than they are graded.

3M™ Flap Discs

3M™ Flap Discs 566A

- A versatile flap disc for a great balance of cut and life on any metalworking application
- YF wt. cloth backing
- Alumina zirconia works on all metals

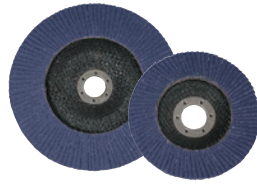

UPC	Dia. x Ctr. Hole	Grade	Max. RPM	Qty./Case
Type 27				
051141-55362-7	4-1/2" x 5/8-11*	40	13,300	10
051141-55363-4	4-1/2" x 5/8-11*	60	13,300	10
051141-55364-1	4-1/2" x 5/8-11*	80	13,300	10
051141-55366-5	4-1/2" x 7/8"	40	13,300	10
051141-55367-2	4-1/2" x 7/8"	60	13,300	10
051141-55368-9	4-1/2" x 7/8"	80	13,300	10
051141-55370-2	7" x 5/8-11*	40	8,600	5
051141-55371-9	7" x 5/8-11*	60	8,600	5
051141-55372-6	7" x 5/8-11*	80	8,600	5
051141-55374-0	7" x 7/8"	40	8,600	5
051141-55375-7	7" x 7/8"	60	8,600	5
051141-55376-4	7" x 7/8"	80	8,600	5

UPC	Dia. x Ctr. Hole	Grade	Max. RPM	Qty./Case
Type 29				
051141-55402-0	4-1/2" x 5/8-11*	40	13,300	10
051141-55403-7	4-1/2" x 5/8-11*	60	13,300	10
051141-55404-4	4-1/2" x 5/8-11*	80	13,300	10
051141-55406-8	4-1/2" x 7/8"	40	13,300	10
051141-55407-5	4-1/2" x 7/8"	60	13,300	10
051141-55408-2	4-1/2" x 7/8"	80	13,300	10
051141-55410-5	7" x 5/8-11*	40	8,600	5
051141-55411-2	7" x 5/8-11*	60	8,600	5
051141-55412-9	7" x 5/8-11*	80	8,600	5
051141-55414-3	7" x 7/8"	40	8,600	5
051141-55415-0	7" x 7/8"	60	8,600	5
051141-55416-7	7" x 7/8"	80	8,600	5

*Quick Change Hub Attachment

3M™ Giant Flap Discs 566A

- A versatile flap disc for a great balance of cut and life on any metalworking application
- Packed with 25% more abrasive material than standard 3M™ Flap Discs 566A
- Delivers longer life and fewer disc changes
- Alumina zirconia works on all metals



UPC	Dia. x Ctr. Hole	Grade	Max. RPM	Qty./Case
Type 27				
051141-55378-8	4-1/2" x 5/8-11*	40	13,300	10
051141-55379-5	4-1/2" x 5/8-11*	60	13,300	10
051141-55380-1	4-1/2" x 5/8-11*	80	13,300	10
051141-55382-5	4-1/2" x 7/8"	40	13,300	10
051141-55383-2	4-1/2" x 7/8"	60	13,300	10
051141-55384-9	4-1/2" x 7/8"	80	13,300	10
051141-55386-3	7" x 5/8-11*	40	8,600	5
051141-55387-0	7" x 5/8-11*	60	8,600	5
051141-55388-7	7" x 5/8-11*	80	8,600	5
051141-55390-0	7" x 7/8"	40	8,600	5
051141-55391-7	7" x 7/8"	60	8,600	5
051141-55392-4	7" x 7/8"	80	8,600	5

UPC	Dia. x Ctr. Hole	Grade	Max. RPM	Qty./Case
Type 29				
051141-55418-1	4-1/2" x 5/8-11*	40	13,300	10
051141-55419-8	4-1/2" x 5/8-11*	60	13,300	10
051141-55420-4	4-1/2" x 5/8-11*	80	13,300	10
051141-55423-5	4-1/2" x 7/8"	60	13,300	10
051141-55424-2	4-1/2" x 7/8"	80	13,300	10
051141-55426-6	7" x 5/8-11*	40	8,600	5
051141-55427-3	7" x 5/8-11*	60	8,600	5
051141-55428-0	7" x 5/8-11*	80	8,600	5
051141-55430-3	7" x 7/8"	40	8,600	5
051141-55431-0	7" x 7/8"	60	8,600	5
051141-55432-7	7" x 7/8"	80	8,600	5

*Quick Change Hub Attachment

**More Material.
Longer Life.**

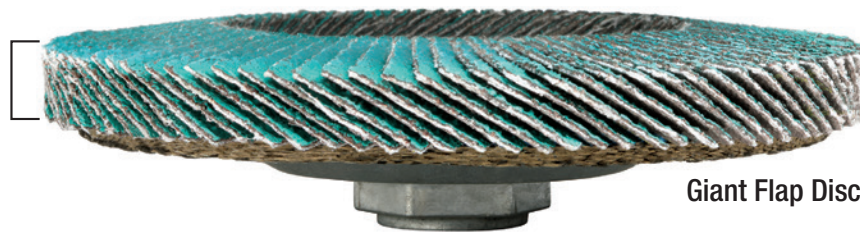

Giant Flap Disc

Standard Flap Disc

3M™ Flap Discs

3M™ Flap Discs 577F

- Versatile alumina zirconia mineral works on a variety of metals and applications
- Durable YF wt. polyester backing designed for long life on the most heavy duty grinding applications

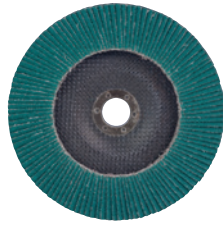

UPC	Dia. x Ctr. Hole	Grade	Max. RPM	Qty./Case
Type 29				
051141-30983-5	4-1/2" x 5/8-11*	36	13,300	10
051141-30984-2	4-1/2" x 5/8-11*	40	13,300	10
051141-30985-9	4-1/2" x 5/8-11*	60	13,300	10
051141-30986-6	4-1/2" x 5/8-11*	80	13,300	10
051141-30987-3	4-1/2" x 7/8"	36	13,300	10
051141-30988-0	4-1/2" x 7/8"	40	13,300	10
051141-30989-7	4-1/2" x 7/8"	60	13,300	10
051141-30990-3	4-1/2" x 7/8"	80	13,300	10
051141-30991-0	7" x 5/8-11*	36	8,600	5
051141-30992-7	7" x 5/8-11*	40	8,600	5
051141-30993-4	7" x 5/8-11*	60	8,600	5
051141-30994-1	7" x 5/8-11*	80	8,600	5
051141-30995-8	7" x 7/8"	36	8,600	5
051141-30996-5	7" x 7/8"	40	8,600	5
051141-30997-2	7" x 7/8"	60	8,600	5
051141-30998-9	7" x 7/8"	80	8,600	5

Type 27

051141-30951-4	4-1/2" x 5/8-11*	36	13,300	10
051141-30952-1	4-1/2" x 5/8-11*	40	13,300	10
051141-30953-8	4-1/2" x 5/8-11*	60	13,300	10
051141-30954-5	4-1/2" x 5/8-11*	80	13,300	10
051141-30955-2	4-1/2" x 7/8"	36	13,300	10
051141-30956-9	4-1/2" x 7/8"	40	13,300	10
051141-30957-6	4-1/2" x 7/8"	60	13,300	10
051141-30958-3	4-1/2" x 7/8"	80	13,300	10
051141-30963-7	7" x 5/8-11*	36	8,600	5
051141-30964-4	7" x 5/8-11*	40	8,600	5
051141-30965-1	7" x 5/8-11*	60	8,600	5
051141-30966-8	7" x 5/8-11*	80	8,600	5
051141-30959-0	7" x 7/8"	36	8,600	5
051141-30960-6	7" x 7/8"	40	8,600	5
051141-30961-3	7" x 7/8"	60	8,600	5
051141-30962-0	7" x 7/8"	80	8,600	5

*Quick Change Hub Attachment

3M™ Giant Flap Discs 577F

- Versatile alumina zirconia mineral works on a variety of metals and applications
- 25% more flaps than standard 3M™ Flap Discs 577F
- Delivers longer life and fewer disc changes

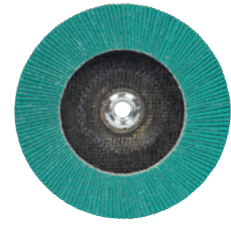

UPC	Dia. x Ctr. Hole	Grade	Max. RPM	Qty./Case
Type 29				
051141-30999-6	4-1/2" x 5/8-11*	36	13,300	10
051141-31000-8	4-1/2" x 5/8-11*	40	13,300	10
051141-31001-5	4-1/2" x 5/8-11*	60	13,300	10
051141-31002-2	4-1/2" x 5/8-11*	80	13,300	10
051141-31003-9	4-1/2" x 7/8"	36	13,300	10
051141-31004-6	4-1/2" x 7/8"	40	13,300	10
051141-31005-3	4-1/2" x 7/8"	60	13,300	10
051141-31006-0	4-1/2" x 7/8"	80	13,300	10
051141-31011-4	7" x 5/8-11*	36	8,600	5
051141-31012-1	7" x 5/8-11*	40	8,600	5
051141-31013-8	7" x 5/8-11*	60	8,600	5
051141-31014-5	7" x 5/8-11*	80	8,600	5
051141-31007-7	7" x 7/8"	36	8,600	5
051141-31008-4	7" x 7/8"	40	8,600	5
051141-31009-1	7" x 7/8"	60	8,600	5
051141-31010-7	7" x 7/8"	80	8,600	5

Type 27

051141-30967-5	4-1/2" x 5/8-11*	36	13,300	10
051141-30968-2	4-1/2" x 5/8-11*	40	13,300	10
051141-30969-9	4-1/2" x 5/8-11*	60	13,300	10
051141-30970-5	4-1/2" x 5/8-11*	80	13,300	10
051141-30971-2	4-1/2" x 7/8"	36	13,300	10
051141-30972-9	4-1/2" x 7/8"	40	13,300	10
051141-30973-6	4-1/2" x 7/8"	60	13,300	10
051141-30974-3	4-1/2" x 7/8"	80	13,300	10
051141-30979-8	7" x 5/8-11*	36	8,600	5
051141-30980-4	7" x 5/8-11*	40	8,600	5
051141-30981-1	7" x 5/8-11*	60	8,600	5
051141-30982-8	7" x 5/8-11*	80	8,600	5
051141-30975-0	7" x 7/8"	36	8,600	5
051141-30976-7	7" x 7/8"	40	8,600	5
051141-30977-4	7" x 7/8"	60	8,600	5
051141-30978-1	7" x 7/8"	80	8,600	5

*Quick Change Hub Attachment

Scotch-Brite™ Discs

Make tough jobs easier. Scotch-Brite™ Discs can help you achieve a burr-free, paintable finish in fewer steps without damaging the base material. The non-woven, open web, durable construction is designed to resist loading and greatly increase the life of the disc. As a result, you will not have to change it as often. However, when you do change your disc, the Roloc™ attachment or Hook-and-Loop attachment makes it fast and easy.



Scotch-Brite™ Disc Selection Guide

	Light Grinding	Blending	Deburring	Finishing	Cleaning	Coating Removal
Increased Loading Resistance	SC, PD	SC, PD	SC	PD, HS, C&F	Bristle, HS, C&F	Bristle, HS
Starting Point	SL	SL	SE	SC	PD	C&S
Increased Wear Resistance	LGB	LGB	LGB	SL	SC	C&S XT

Legend						
PD	PD Surface Conditioning Discs	SE	SE Surface Conditioning Discs	C&F	Clean and Finish Discs	
LGB	Light Grinding and Blending Discs	SL	SL Surface Conditioning Discs	C&S	Clean and Strip Discs	
SC	SC Surface Conditioning Discs	HS	High Strength Discs	C&S XT	Clean and Strip XT Discs	

Scotch-Brite™ Disc Performance Comparison — Choose the right disc for the job.

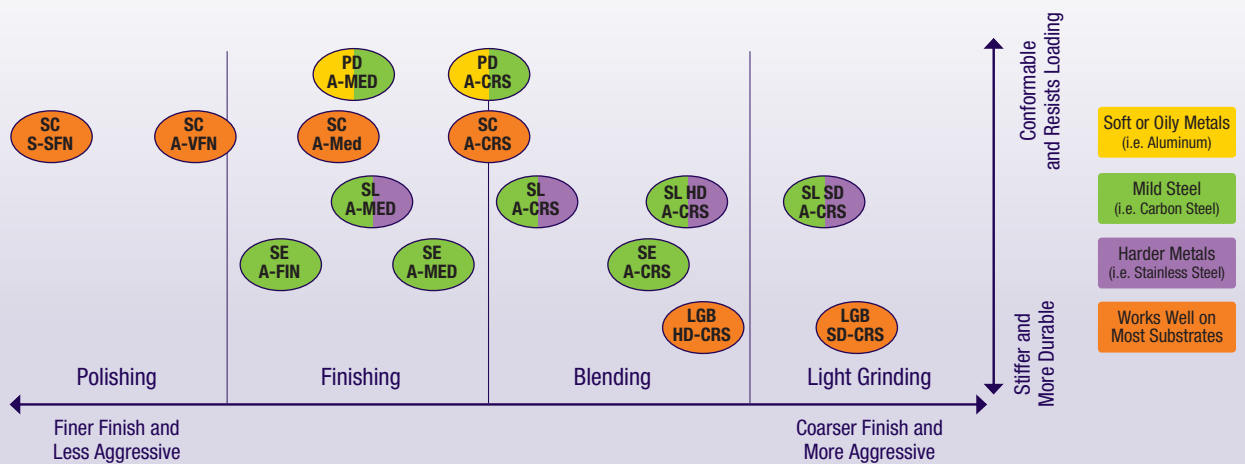

Scotch-Brite™ Discs — Hook-and-Loop

Scotch-Brite™ SC Surface Conditioning Discs (Hook-and-Loop)

- Aluminum oxide
- Great general purpose surface conditioning disc
- For finishing, cleaning, and light deburring
- Attach and remove easily to 3M™ Hook-and-Loop Backup Pads
- Use with right angle and random orbital tools



UPC	Diameter	Grade	Color	Max. RPM	Min./Case
048011-07458-0	2"	A CRS	Brown	23,000	50/200
048011-07459-7	2"	A MED	Maroon	23,000	50/200
048011-04276-3	2"	A VFN	Blue	23,000	50/200
048011-04127-8†	2"	A SFN	Gray	23,000	50/200
048011-04120-9	3"	A CRS	Brown	20,000	25/100
048011-04124-7	3"	A MED	Maroon	20,000	25/100
048011-04277-0	3"	A VFN	Blue	20,000	25/100
048011-04129-2	3"	A SFN	Gray	20,000	100
048011-04128-5	3"	A SFN	Gray	20,000	100
048011-07450-4	4"	A CRS	Brown	13,000	100
048011-07451-1	4"	A MED	Maroon	13,000	100
048011-04278-7	4"	A VFN	Blue	13,000	100
048011-04129-2	4"	A SFN	Gray	13,000	100
048011-14101-5	4-1/2"	A CRS	Brown	13,000	50
048011-27671-7	4-1/2"	A CRS	Brown	13,000	10
048011-27672-4	4-1/2"	A MED	Maroon	13,000	10
048011-14100-8	4-1/2"	A MED	Maroon	13,000	50
048011-14099-5	4-1/2"	A VFN	Blue	13,000	50
048011-14102-2	4-1/2"	A SFN	Gray	13,000	50
048011-27674-8	5"	A CRS	Brown	10,000	10
048011-00750-2	5"	A CRS	Brown	10,000	50
048011-27675-5	5"	A MED	Maroon	10,000	10
048011-00643-7	5"	A MED	Maroon	10,000	50
048011-27676-2	5"	A VFN	Blue	10,000	10
048011-04303-6	5"	A VFN	Blue	10,000	50
048011-00647-5	5"	A SFN	Gray	10,000	50
048011-03927-5	6"	A CRS	Brown	8,000	50
048011-03928-2	6"	A MED	Maroon	8,000	50
048011-04304-3	6"	A VFN	Blue	8,000	50
048011-27677-9	7"	A CRS	Brown	6,000	10
048011-00751-9	7"	A CRS	Brown	6,000	25
048011-27678-6	7"	A MED	Maroon	6,000	10
048011-00645-1	7"	A MED	Maroon	6,000	25
048011-27679-3	7"	A VFN	Blue	6,000	10
048011-04305-0	7"	A VFN	Blue	6,000	25
048011-00648-2	7"	A SFN	Gray	6,000	25

† Made-to-Order

Scotch-Brite™ SC Surface Conditioning Discs (Hook-and-Loop) (cont.)

UPC	Diameter	Grade	Color	Max. RPM	Min./Case
048011-00752-6	8"	A CRS	Brown	6,000	25
048011-00670-3	8"	A MED	Maroon	6,000	25
048011-04306-7	8"	A VFN	Blue	6,000	25
048011-00649-9†	8"	A SFN	Gray	6,000	25
048011-13325-6†	48"	A CRS	Brown	600	2
048011-13100-9†	48"	A MED	Maroon	600	2
048011-13099-6†	48"	A VFN	Blue	600	2
048011-18385-5†	48"	A SFN	Gray	600	2

† Made-to-Order

Scotch-Brite™ SL Surface Conditioning Discs (Hook-and-Loop)

- Aluminum oxide
- Highly durable product for aggressive applications
- Cuts fast without sacrificing finish and can work twice as long as other standard surface conditioning discs

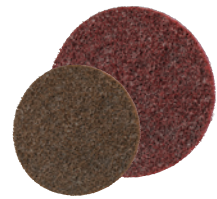

UPC	Diameter	Grade	Max. RPM	Qty./Case
048011-33813-2†	4"	A CRS SD	13,000	100
048011-33810-1†	4"	A CRS HD	13,000	100
048011-33807-1†	4"	A CRS	13,000	25/100
048011-33804-0†	4"	A MED	13,000	100
048011-33814-9	4-1/2"	A CRS SD	13,000	50
048011-33811-8	4-1/2"	A CRS HD	13,000	50
048011-33808-8	4-1/2"	A CRS	13,000	50
048011-33805-7	4-1/2"	A MED	13,000	50
048011-33815-6†	5"	A CRS SD	10,000	50
048011-33812-5†	5"	A CRS SD	10,000	50
048011-33806-4†	5"	A CRS HD	10,000	50
048011-33809-5†	5"	A MED	10,000	50
048011-33789-0	7"	A CRS SD	6,000	25
048011-33788-3	7"	A CRS HD	6,000	25
048011-33787-6	7"	A CRS	6,000	25
048011-33786-9	7"	A MED	6,000	25

† Made-to-Order

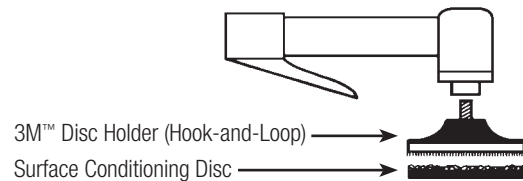

Scotch-Brite™ Discs — Hook-and-Loop

Scotch-Brite™ SE Surface Conditioning Discs (Hook-and-Loop)

- High cutting surface conditioning disc great for edge deburring applications



UPC	Diameter	Grade	Max. RPM	Min./Case
048011-18021-2	4"	A CRS	13,000	100
048011-18475-3†	4"	A MED	13,000	100
048011-18079-3	4-1/2"	A CRS	13,000	50
048011-18476-0	4-1/2"	A MED	13,000	50
048011-18080-9	5"	A CRS	10,000	50
048011-18919-2†	5"	A MED	10,000	50
048011-17866-0	7"	A CRS	6,000	25
048011-18477-7	7"	A MED	6,000	25
048011-30003-0†	7"	A FIN	6,000	25
048011-17239-2	8"	A CRS	6,000	25
048011-93348-1†	48"	A CRS	600	2
048011-60392-6†	48"	A FIN	600	2

† Made-to-Order

Scotch-Brite™ Clean and Finish Discs (Hook-and-Loop)

- Flexible web for finishing, blending and polishing
- Conformability allows access to hard-to-reach areas



UPC	Diameter	Grade	Max. RPM	Qty./Case
048011-16001-6	5"	A VFN	5,000	100
048011-00661-1	6"	A VFN	4,000	100
048011-30037-5	11-1/4"	A VFN	1,900	25

Scotch-Brite™ Light Grinding and Blending Disc (Hook-and-Loop)

- Durable, non-woven 3M ceramic aluminum oxide blend abrasive grain product used for light grinding applications providing burr-free finish
- For use with the 3M™ Center Pin Backup Pad or 3M™ Fibre Disc Hubs, Face Plates and Retainer Nuts
- Super Duty = Blue; Heavy Duty = Maroon



UPC	Dia. x Ctr. Hole	Grade	Max. RPM	Min./Case
048011-60335-3	4-1/2"	A CRS HD	10,000	50
048011-60342-1	5"	A CRS HD	10,000	50
048011-60345-2	7"	A CRS HD	6,000	25

† Made-to-Order

Scotch-Brite™ Coating Removal Discs (Hook-and-Loop)

- Extra coarse grade silicon carbide
- Made for right-angle tools from aggressive Clean & Strip web
- Non-loading design ideal for removing rust and coatings
- Mount on Hook-and-Loop Disc Pad Holders



UPC	Diameter	Grade	Max. RPM	Min./Case
Hook-and-Loop				
048011-18424-1	4-1/2"	S XCS	12,000	4/20
048011-18482-1*	4-1/2"	S XCS	12,000	40
048011-18355-8	5"	S XCS	10,000	4/20
048011-18483-8*	5"	S XCS	10,000	40
048011-18358-9	7"	S XCS	6,000	2/10
048011-18485-2*	7"	S XCS	6,000	20

*Bulk

Scotch-Brite™ Discs — Center Hole

Scotch-Brite™ HS Blend & Finish Discs

- Flexible and aggressive
- Tackles weld burn and refinement, light deburring and rust removal
- Produces a beautifully blended, burr-free finish



UPC	Dia. x Ctr. Hole	Grade	Max. RPM	Qty./Case
048011-64145-4	6" x 1/2"	A MED	4,000	100
048011-64169-0	8" x 1/2"	A MED	3,000	50
048011-64183-6	12" x 1-1/4"	A MED	1,900	25

Scotch-Brite™ Light Grinding and Blending Center Hole Disc

- Durable, non-woven 3M ceramic aluminum oxide blend abrasive grain product used for light grinding applications providing burr-free finish
- For use with the 3M™ Center Pin Backup Pad or 3M™ Fibre Disc Hubs, Face Plates and Retainer Nuts
- Super Duty = Blue; Heavy Duty = Maroon



UPC	Dia. x Ctr. Hole	Grade	Max. RPM	Min./Case
048011-60363-6	4-1/2"	A CRS SD	10,000	50
048011-60333-9†	4-1/2" x 7/8"	A CRS SD	10,000	50
048011-60332-2†	4-1/2" x 7/8"	A CRS HD	10,000	50
048011-60343-8	5"	A CRS SD	10,000	50
048011-60341-4	5" x 7/8"	A CRS SD	10,000	50
048011-60336-0	5" x 7/8"	A CRS HD	10,000	50
048011-60346-9	7"	A CRS SD	6,000	25
048011-60344-5	7" x 7/8"	A CRS SD	6,000	25
048011-60347-6	7" x 7/8"	A CRS HD	6,000	25

† Made-to-Order

Scotch-Brite™ Discs — TN Quick Change

Scotch-Brite™ Light Grinding and Blending Discs TN Quick Change

- 3M ceramic abrasive grain
- Aggressive, long life, consistent finish
- Resistant to edge wear
- Super Duty: Blue
- Heavy Duty: Maroon



UPC	Diameter x AH	Grade	Max. RPM	Qty./Case
048011-60349-0	4-1/2" x 5/8-11*	A CRS SD	13,000	50
048011-60348-3	4-1/2" x 5/8-11*	A CRS HD	13,000	50
048011-60351-3	5" x 5/8-11*	A CRS SD	12,000	50
048011-60350-6	5" x 5/8-11*	A CRS HD	12,000	50
048011-60353-7	7" x 5/8-11*	A CRS SD	8,600	25
048011-60352-0	7" x 5/8-11*	A CRS HD	8,600	25

*Quick Change Tinneman Nut Attachment

Scotch-Brite™ EXL Unitized Discs

- High performance and durability for deburring and finishing applications
- A layered, durable unitized disc construction



UPC	Dia. x Ctr. Hole	Grade	Max. RPM	Qty./Case
Type 27				
048011-28201-4	4-1/2" x 7/8"	2S FIN	11,000	5
048011-27689-2	4-1/2" x 7/8"	6S FIN	13,300	5
048011-29200-7	4-1/2" x 7/8"	8A CRS	13,300	5

Scotch-Brite™ Clean and Strip XT Disc, TN Quick Change

- Extra coarse grade silicon carbide
- Mounts quickly to 4-1/2" and 7" grinders
- Tough open web, ideal for weld cleaning and removing paint and coatings
- Use with TN Quick Change backup pad or fibre disc hub and face plate



UPC	Dia. x Thk. X AH	Grade	Max. RPM	Min./Case
048011-33194-2	4-1/2" x 1/2" x 5/8-11*	S XCS	13,300	10
048011-33196-6	7" x 1/2" x 5/8-11*	S XCS	8,600	5

*Quick Change Tinneman Nut Attachment

Scotch-Brite™ Bristle Discs

- Easily remove paint, stains, adhesives, weld burn, rust and other surface contaminants from large areas

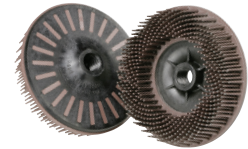

UPC	Diameter x AH	Grade	Color	Max. RPM	Qty./Case
048011-33054-9	4-1/2" x 5/8-11 INT	36	Brown	12,000	10
048011-24241-5	4-1/2" x 5/8-11 INT	50	Green	12,000	10
048011-24242-2	4-1/2" x 5/8-11 INT	80	Yellow	12,000	10
048011-24243-9	4-1/2" x 5/8-11 INT	120	White	12,000	10

Scotch-Brite™ Surface Conditioning Disc Packs

Scotch-Brite™ Surface Conditioning Disc Pack 9145S, 915S, 917S

- Contains a variety of grades of non-woven surface conditioning discs
- Used for cleaning, finishing, blending and deburring applications
- Includes 9145 disc pad holder

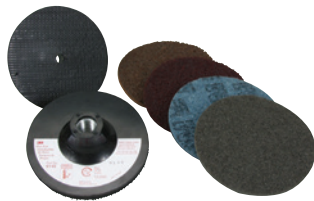

9145S Shown

UPC	Max RPM	Catalog No.	Size	Min./Case
048011-14105-3	13,000	9145S	4-1/2"	1/5
048011-08713-9	10,000	915S	5"	1/5
048011-04270-1	6,000	917S	7"	1/5

Scotch-Brite™ Surface Conditioning Disc Pack 920S

- Contains a variety of grades of 2" and 3" non-woven surface conditioning discs
- Used for cleaning, finishing, blending and deburring applications
- Includes 922 and 923 disc pad holder



UPC	Size	Min./Case
048011-18253-7	2" and 3"	1/5

3M™ Power Tools for 3M™ Right Angle Disc Systems

3M™ Disc Sanders

- Versatile, durable and powerful
- 3M™ Gripping Material for added comfort and reduced vibration
- Use with 3M™ and Scotch-Brite™ Abrasive Discs and Disc Accessories for a variety of metalworking applications



Model No.	Tool Dia. Inch (mm)	Motor HP (W)	Max RPM	Weight Pound (kg)	Length Inch (mm)	Height Inch (mm)	Air Inlet Thread	Airflow Rate SCFM (LPM)	Exhaust Direction	UPC
28408	4-5 (100-127)	1 (744)	12,000	2.31 (1.05)	8.25 (209.6)	4.23 (107.4)	3/8" NPT*	37 (1,048)	Rear	051141-28408-8
28622	4-5 (100-127)	1 (744)	12,000	4.03 (1.83)	11.5 (292)	4.70 (119)	3/8" NPT*	37 (1,048)	—	051141-28622-8

*Includes 3/8" to 1/4" reducer

3M™ Power Tools for 3M™ Right Angle Disc Systems















3M™ Sander/Buffer

Model No.	Tool Dia. Inch (mm)	Motor HP (W)	Max RPM	Weight Pound (kg)	Length Inch (mm)	Height Inch (mm)	Air Inlet Thread	Airflow Rate SCFM (LPM)	UPC
28773	5-6 (127-152)	1 (744)	3,500	3.3 (1.5)	10 (254)	4 (95)	1/4" NPT	37 (1,048)	051141-28773-7

Accessories for 3M™ Right Angle Disc Systems

Product Name	UPC	Qty./Case	For Use With	Size/Description	Max RPM
3M™ Disc Pad Hub 	051141-28442-2	10	Short shaft tools	2-1/2" Diameter; 3/8-24 metal insert	N/A
	051144-45205-7	10	3M™ Disc Pad Face Plates (all sizes)	2-1/2" Diameter; 5/8-11 metal insert	N/A
	051144-88743-9	10	3M™ Disc Pad Face Plates (all sizes, tool shaft length 1/2" or less)	2-1/2" Diameter; 5/8-11 metal insert	N/A
	051144-11824-3	1	3M™ Disc Pad Face Plates (4"-9")	2-1/2" Diameter; 5/8-11 metal insert	N/A
	051144-11823-6	1	3M™ Disc Pad Face Plates (7"-9")	4-1/2" Diameter; 5/8-11 metal insert	N/A
	051144-45190-6	10	3M™ Disc Pad Face Plates (7"-9")	4-1/2" Diameter; 5/8-11 metal insert	N/A
3M™ Low Profile Disc Pad Hub 	051141-28476-7	10	3M™ Disc Pad Face Plates (all sizes, tool shaft length 1/2" or less; 5/8" or more)	2-1/2" Diameter; 5/8-11 metal insert	N/A
3M™ Disc Pad Face Plates 	051144-13325-3	10	Fibre Discs	4-1/2" Diameter; Smooth; Medium – Gray	13,300
	051144-14270-5	10	Fibre Discs	4-1/2" Diameter; Smooth; Hard – Black	13,300
	051141-28443-9	10	Fibre Discs	4-1/2" Diameter; Ribbed; Extra Hard – Red	13,300
	051144-81734-4	10	Fibre Discs	5" Diameter; Ribbed; Medium – Gray	12,000
	051144-81733-7	10	Fibre Discs	5" Diameter; Ribbed; Hard – Black	12,000
	051144-81732-0	10	Fibre Discs	5" Diameter; Ribbed; Extra Hard – Red	12,000
	051144-80516-7	10	Fibre Discs	7" Diameter; Ribbed; Medium – Gray	8,600
	051144-80515-0	10	Fibre Discs	7" Diameter; Ribbed; Hard – Black	8,600
	051144-80514-3	10	Fibre Discs	7" Diameter; Ribbed; Extra Hard – Red	8,600
	051144-81729-0	10	Fibre Discs	9" Diameter; Ribbed; Hard – Black	6,600
	051144-81728-3	10	Fibre Discs	9" Diameter; Ribbed; Extra Hard – Red	6,600
	3M™ TN Quick Change Disc Backup Pad 	051111-56573-5	5	4-1/2" TN Discs	4-1/2" x 5/8-11 INT
3M™ Disc Retainer Nuts 	051111 -51047-6	10	3M™ Disc Pad Face Plates and Disc Pad Hubs	5/16" Depth; 5/8-11 Thread	N/A
	051144 -05622-4	10		3/8" Depth; 5/8-11 Thread	N/A
	051144 -05621-7	10		1/2" Depth; 5/8-11 Thread	N/A
	051144 -05620-0	10		5/8" Depth; 5/8-11 Thread	N/A

Accessories for 3M™ Right Angle Disc Systems

Product Name	UPC	Qty./Case	For Use With	Size/Description	Max RPM
3M™ Disc Holder Adapter No. 9 	048011-22971-3	10	Converts grinders with M10–1.25, M10–1.5 or 3/8–24 EXT threaded shaft to a 5/8–11 EXT threaded shaft	M10–1.25 INT	N/A
	048011-22972-0	10		M10–1.50 INT	N/A
	048011-22970-6	10		3/8–24 INT	N/A
Flap Disc Adapter Nut 	051144-88765-1	1 Pair/ 5 Pairs	Secures 4-1/2" diameter flap discs to right angle tool with a 5/8–11 threaded shaft	5/8–11 Thread	N/A
Flap Disc Holder 	051144-88769-9	1	Backup plate for 7" diameter flap discs	4" Diameter; 5/8–11 Thread	N/A
3M™ Hook-and-Loop Disc Pad Holder 	051141-20245-7	1	Scotch-Brite™ Light Grinding and Blending Disc Accessories	7" x 7/8" Center Post; 5/8–11 INT	8,500
3M™ Hook-and-Loop Disc Pad Holders 	048011-07494-8	10	Scotch-Brite™ Surface Conditioning Discs	2" (1/4" shank); Cat. No. 922	23,000
Disc Pad Holder No. 922 and 923	048011-04132-2	10	Scotch-Brite™ Surface Conditioning Discs	3" (1/4" shank); Cat. No. 923	20,000
Disc Pad Holder No. 924 	048011-07492-4	5	Scotch-Brite™ Surface Conditioning Discs	4" (1/4" shank); Cat. No. 924	13,000
Disc Pad Holder No. 914 	048011-05674-6	1	Scotch-Brite™ Surface Conditioning Discs	4" x 1/8" x 3/8" 5/8–11 INT; Cat. No. 914	13,000
Disc Pad Holder No. 9145 and 915 	048011-14111-4	1	Scotch-Brite™ Surface Conditioning Discs	4-1/2" x 5/8–11 INT; Cat. No. 9145	13,000
	048011-05680-7	1	Scotch-Brite™ Surface Conditioning Discs	5" x 5/8–11 INT; Cat. No. 915	13,000
Disc Pad Holder No. 917 	048011-09450-2	1	Scotch-Brite™ Surface Conditioning Discs	7" x 5/8–11 INT; Cat. No. 917	6,000
Disc Pad Holder No. 947TH 	051141-20279-2	1	Scotch-Brite™ Surface Conditioning Discs	7" x 1" x 5/8–11 INT; Cat. No. 947TH	6,000
Disc Pad Holder No. 918 	048011-09451-9	1	Scotch-Brite™ Surface Conditioning Discs	8" x 5/16" x 3/8" 5/8–11 INT; Cat. No. 918	6,000
3M™ Hookit™ Disc Pad 	051144-85096-9	10	Scotch-Brite™ Coating Removal Discs	5" x 5/8" x 5/8–11 INT	12,000
	051144-85105-8	10	Scotch-Brite™ Coating Removal Discs	5" x 3/4" x 5/8–11 INT	12,000
	051144-13627-8	1	Scotch-Brite™ Coating Removal Discs	7" x 1" x 5/8–11 INT	6,000
3M™ Stikit™ Disc Pads 	051144-05579-1	1	3M™ Stikit™ Discs	8" x 5/8–11 INT	3,000
	051111-55813-3	5	3M™ Stikit™ Discs	5" x 1/2" 5/8–11 INT	12,000
	051144-82189-1	10	3M™ Stikit™ Discs	5" x 3/4" 5/8–11 INT	12,000



3M™ Roloc™ Discs

3M™ Roloc™ Discs provide a fast, efficient method for grinding, blending, leveling and finishing on all types of metal. They lock securely in place with just a half twist. . .another half twist and they're off. Each disc is color coded by grade. (This does not include 3M Roloc TSM products.)

3M™ Roloc™ Cloth Disc Selection Guide





Product	Mineral Type	Features	Metal Type	Performance	Grinding	Light Grinding	Blending	Deburring
361F	Aluminum Oxide	General purpose grinding, light grinding, blending, and deburring on all metals	All Metals	Good	■	■	■	■
461F	Silicon Carbide	Ideal for grinding glass, titanium and non-ferrous metals	Titanium	Good		■	■	■
777F	Ceramic Aluminum Oxide Blend	Durable Y wt. Cloth backing; Grinding aid	Stainless Steel; Nickel Alloy	Better	□	□	□	□
963G	Ceramic Abrasive Grain	Durable backing	Carbon Steel	Best	■	■	■	■
977F	Ceramic Abrasive Grain	Durable 2-ply backing; Grinding aid	Stainless Steel; Nickel Alloy	Best	■	■	■	■
984F	Precision Shaped Ceramic Grain	Durable 2-ply backing; Grinding aid; Fastest cutting	All Metals	Premium	■	■	■	■

3M™ Roloc™ Fiber Disc Selection Guide

Product	Mineral Type	Features	Metal Type	Performance	Grinding	Light Grinding	Blending	Deburring
501C	Aluminum Zirconia	Versatile disc for use on a wide variety of metals; General purpose grinding, blending and finishing on all metals	All Metals	Good	■	■		■
785C	Ceramic Aluminum Oxide Blend	Excellent for stainless steel; Grinding aid	Stainless Steel	Better	□	□		□
988R	Ceramic Abrasive Grain	Unique single-piece construction that can eliminate button delamination and enhance disc performance; Cut through metal stock to quickly level welds and take on tough jobs in small areas	Mild Steel	Best	■	■		■
982C	Precision Shaped Ceramic Grain	Fastest cutting; Longest life	All Metals	Premium	■	■		■

3M™ Roloc™ Discs

3M™ Roloc™ Attachment System Guide

Product ID	Attachment Type				Diameter	Attachment Type			
	TP	TR	TSM	TS		TP	TR	TSM	TS
361F	•	•	•		3/4"	•	•		•
461F		•			1"	•	•	•	•
777F		•	•	•	1-1/2"	•	•	•	•
963G		•			2"	•	•	•	•
977F		•			3"	•	•	•	•
982C		•	•		4"	•	•		•
984F		•	•						
501C		•	•		TP (Plastic Button)	TR (Plastic Button)			
785C		•							
983C/988C		•			TSM (Metal Button)	TS (Plastic Button)			
988R		•							

Roloc™ Disc Button Color/Grade Chart

● 24/Black	● 80/Yellow	● 150/Black
● 36/Brown	● 100/Blue	● 180/Brown
● 50/Green	○ 120/White	● 240/Green
● 60/Orange		

Optimum Tool Speeds to Maximize 3M™ Roloc™ Disc Cut Rates and Life



Disc Size	Material			
	Stainless	Aluminum	Steel	Titanium
1-1/2"	20,000 RPM	30,000 RPM	30,000 RPM	9,000 RPM
2"	15,000 RPM	20,000 RPM	20,000 RPM	7,000 RPM
3"	10,000 RPM	15,000 RPM	15,000 RPM	4,500 RPM
4"	8,000 RPM	9,000 RPM	9,000 RPM	3,000 RPM

3M™ Cubitron™ II Roloc™ Discs

3M™ Cubitron™ II Roloc™ Fibre Disc 982C



- Made with revolutionary 3M precision shaped grain technology
- Provides long life and fast cut
- Rigid fibre backing enables fast, more aggressive cutting
- Optimized for use on carbon steel

UPC	Diameter	Grade	Max. RPM	Min./Case
Roloc TR (Plastic Button) 				
051115-66778-7	2"	36+	25,000	50/200
051115-66783-1	2"	60+	25,000	50/200
051115-66788-6	2"	80+	25,000	50/200
051115-66779-4	3"	36+	20,000	50/200
051115-66784-8	3"	60+	20,000	50/200
051115-66789-3	3"	80+	20,000	50/200
051115-66780-0	4"	36+	12,000	25/100
051115-66785-5	4"	60+	12,000	25/100
051115-66790-9	4"	80+	12,000	25/100
Roloc TSM (Metal Button) 				
051115-66781-7	2"	36+	25,000	50/200
051115-66786-2	2"	60+	25,000	50/200
051115-66791-6	2"	80+	25,000	50/200
051115-66782-4	3"	36+	20,000	50/200
051115-66787-9	3"	60+	20,000	50/200
051115-66792-3	3"	80+	20,000	50/200

3M Precision Shaped Grain

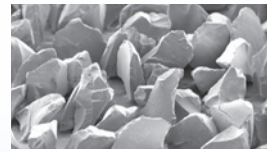

Conventional Grain

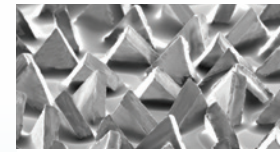

Precision Shaped Grain

Triangular-shaped grain (right) is electrostatically oriented to form sharp peaks, each acting like individual cutting tools that wear evenly for super long life and consistency.



Conventional Ceramic



3M™ Cubitron™ II

3M precision shaped grain sharpens as it wears. Compared to conventional ceramic abrasive grain, 3M™ Cubitron™ II Abrasive Discs **cut faster and last longer!**



CUBITRON II

3M™ Cubitron™ II Roloc™ Durable Edge Disc 984F

NEW!



- Made with revolutionary 3M precision shaped grain technology
- Features a durable edge backing and a grinding aid
- For grinding, blending and deburring of light to medium pressure applications for virtually all metal types

UPC	Diameter	Grade	Max. RPM	Min./Case
Roloc TR (Plastic Button) 				
051144-27700-4	1-1/2"	36+	30,000	50/200
051144-27708-0	1-1/2"	60+	30,000	50/200
051144-27716-5	1-1/2"	80+	30,000	50/200
051144-27701-1	2"	36+	25,000	50/200
051144-27709-7	2"	60+	25,000	50/200
051144-27717-2	2"	80+	25,000	50/200
051144-27702-8	3"	36+	20,000	50/200
051144-27710-3	3"	60+	20,000	50/200
051144-27718-9	3"	80+	20,000	50/200
051144-27703-5	4"	36+	12,000	25/100
051144-27711-0	4"	60+	12,000	25/100
051144-27719-6	4"	80+	12,000	25/100
Roloc TSM (Metal Button) 				
051144-27704-2	1-1/2"	36+	30,000	50/200
051144-27712-7	1-1/2"	60+	30,000	50/200
051144-27720-2	1-1/2"	80+	30,000	50/200
051144-27705-9	2"	36+	25,000	50/200
051144-27713-4	2"	60+	25,000	50/200
051144-27721-9	2"	80+	25,000	50/200
051144-27706-6	3"	36+	20,000	50/200
051144-27714-1	3"	60+	20,000	50/200
051144-27722-6	3"	80+	20,000	50/200
051144-27707-3	4"	36+	12,000	25/100
051144-27715-8	4"	60+	12,000	25/100
051144-27723-3	4"	80+	12,000	25/100

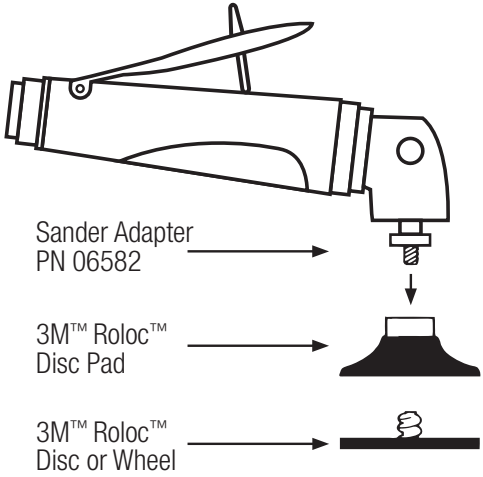

Spacers available for all 5/8–11 tools.

3M™ Roloc™ Discs

3M™ Roloc™ Disc 361F ■



- Aluminum oxide on a YF wt. cloth backing
- General purpose grinding, blending and finishing on all metals



UPC	Diameter	Grade	Max. RPM	Min./Case
Roloc TR (Plastic Button) 				
051144-11412-2	1"	36	30,000	50/500
051144-11411-5	1"	50	30,000	50/500
051144-11417-7	1"	60	30,000	50/500
051144-11416-0	1"	80	30,000	50/500
051144-11415-3	1"	P100	30,000	50/500
051144-11414-6	1"	P120	30,000	50/500
051144-11452-8†	1-1/2"	24	30,000	50/500
051144-22396-1	1-1/2"	36	30,000	50/500
051144-11137-4	1-1/2"	50	30,000	50/500
051144-22397-8	1-1/2"	60	30,000	50/500
051144-22407-4	1-1/2"	80	30,000	50/500
051144-22408-1	1-1/2"	P100	30,000	50/500
051144-22409-8	1-1/2"	P120	30,000	50/500
051144-11000-1	2"	24	25,000	50/200
051144-22398-5	2"	36	25,000	50/200
051144-22399-2	2"	50	25,000	50/200
051144-22400-5	2"	60	25,000	50/200
051144-22401-2	2"	80	25,000	50/200
051144-22402-9	2"	P100	25,000	50/200
051144-22403-6	2"	P120	25,000	50/200
051144-14559-1	2"	P150	25,000	50/200
051144-13873-9	2"	P180	25,000	50/200
051144-11419-1	2"	P240	25,000	50/200
051144-22392-3	3"	24	20,000	50/200
051144-22393-0	3"	36	20,000	50/200
051144-22394-7	3"	50	20,000	50/200
051144-22395-4	3"	60	20,000	50/200
051144-22404-3	3"	80	20,000	50/200
051144-22405-0	3"	P100	20,000	50/200
051144-22406-7	3"	P120	20,000	50/200
051144-82244-7	3"	P150	20,000	50/200
051144-11418-4	3"	P240	20,000	50/200
051144-76429-7	4"	36	12,000	25/100
051144-11421-4	4"	60	12,000	25/100
051144-11420-7	4"	80	12,000	25/100

† Made-to-Order

3M™ Roloc™ Disc 361F

UPC	Diameter	Grade	Max. RPM	Min./Case
Roloc TSM (Metal Button) 				
051111-49932-0	1-1/2"	36	30,000	50/500
051111-49933-7	1-1/2"	60	30,000	50/500
051111-49934-4	1-1/2"	80	30,000	50/500
051111-51039-1	1-1/2"	P100	30,000	50/500
051111-51038-4†	1-1/2"	P120	30,000	50/500
051111-49936-8	2"	36	25,000	50/200
051111-49937-5	2"	60	25,000	50/200
051111-49938-2	2"	80	25,000	50/200
051111-51034-6	2"	P100	25,000	50/200
051111-49939-9	2"	P120	25,000	50/200
051111-51033-9	3"	36	20,000	50/200
051111-49940-5	3"	60	20,000	50/200
051111-49941-2	3"	80	20,000	50/200
051111-49942-9	3"	P100	20,000	50/200
051111-49943-6	3"	P120	20,000	50/200
Roloc TP (Metal Button) 				
051111-82401-4	2"	40	25,000	50/200
051111-76806-6	2"	60	25,000	50/200
051111-76810-3	2"	80	25,000	50/200
051111-77115-8†	2"	100	25,000	50/200
051111-22393-0	3"	36	20,000	50/200
051111-22394-7	3"	50	20,000	50/200
051111-22395-4	3"	60	20,000	50/200
051111-22404-3	3"	80	20,000	50/200
051111-22405-0	3"	P100	20,000	50/200

† Made-to-Order

3M™ Roloc™ Disc 461F

- Silicon carbide on a YF wt. cloth backing gives stainless steel a brighter finish
- Ideal for grinding glass, titanium and non-ferrous metals





UPC	Diameter	Grade	Max. RPM	Min./Case
Roloc TR (Plastic Button) 				
051144-12956-0	2"	P60	25,000	50/200
051144-12954-6	2"	P80	25,000	50/200
051144-12957-7	3"	P60	20,000	50/200
051144-12955-3	3"	P80	20,000	50/200

■ Mild Steel ■ Stainless Steel

3M™ Roloc™ Fibre Disc 501C ■

- Aluminum zirconia
- Durable fibre backing
- Versatile disc for use on a wide variety of metals



UPC	Diameter	Grade	Max. RPM	Min./Case
Roloc TR (Plastic Button) 				
051141-20645-5	2"	36	25,000	50/200
051111-50748-3	2"	50	25,000	50/200
051111-50749-0	2"	60	25,000	50/200
051111-50750-6	2"	80	25,000	50/200
051111-50743-8	3"	36	20,000	50/200
051111-50744-5	3"	50	20,000	50/200
051111-50745-2	3"	60	20,000	50/200
Roloc TSM (Metal Button) 				
051111-50755-1	2"	36	25,000	50/200
051111-50756-8	2"	50	25,000	50/200
051111-50757-5	2"	60	25,000	50/200
051111-50758-2	2"	80	25,000	50/200
051111-50751-3	3"	36	20,000	50/200
051111-50752-0	3"	50	20,000	50/200
051111-50753-7	3"	60	20,000	50/200
051111-50754-4	3"	80	20,000	50/200







3M™ Roloc™ Discs

3M™ Roloc™ Disc 777F ■

- 3M ceramic aluminum oxide blend abrasive grain
- Cloth backing for durability
- Grinding aid for cooler running



UPC	Diameter	Grade	Max. RPM	Min./Case
Roloc TR (Plastic Button) 				
051144-76622-2	1"	36	30,000	50/500
051144-76623-9	1"	50	30,000	50/500
051144-76624-6	1"	60	30,000	50/500
051144-76625-3	1"	80	30,000	50/500
051144-80510-5	1"	P120	30,000	50/500
051144-76626-0	1-1/2"	36	30,000	50/500
051144-76627-7	1-1/2"	50	30,000	50/500
051144-76628-4	1-1/2"	60	30,000	50/500
051144-14660-4	1-1/2"	80	30,000	50/500
051144-80511-2	1-1/2"	P120	30,000	50/500
051144-76629-1	2"	36	25,000	50/200
051144-76630-7	2"	50	25,000	50/200
051144-76433-4	2"	60	25,000	50/200
051144-14661-1	2"	80	25,000	50/200
051144-80508-2	2"	P100	25,000	50/200
051144-80512-9	2"	P120	25,000	50/200
051144-76631-4	3"	36	20,000	50/200
051144-76632-1	3"	50	20,000	50/200
051144-76633-8	3"	60	20,000	50/200
051144-76634-5	3"	80	20,000	50/200
051144-80509-9	3"	P100	20,000	50/200
051144-80513-6	3"	P120	20,000	50/200
Roloc TSM (Metal Button) 				
051111-49949-8	2"	36	25,000	50/200
051111-50253-2	2"	60	25,000	50/200
051111-50254-9	2"	80	25,000	50/200
051111-50255-6	2"	100	25,000	50/200
051111-50256-3	2"	P120	25,000	50/200
051111-50257-0	3"	36	20,000	50/200
Roloc TP (Metal Button) 				
051144-76770-0†	2"	60	25,000	50/200
051144-76743-4†	3"	36	20,000	50/200
051144-76763-2†	3"	36	20,000	50/200
051144-76767-0†	3"	50	20,000	50/200
Roloc TS (Plastic Button) 				
051144-76742-7	2"	36	25,000	50/200
051144-76746-5	2"	50	25,000	50/200
051144-76750-2	2"	60	25,000	50/200
051144-76743-4†	3"	36	20,000	50/200
051144-76747-2†	3"	50	20,000	50/200
051144-76751-9	3"	60	20,000	50/200
051144-76755-7	3"	80	20,000	50/200

† Made-to-Order

■ Mild Steel ■ Stainless Steel

3M™ Roloc™ Discs

3M™ Roloc™ Fibre Disc 785C ■

- 3M ceramic aluminum oxide blend abrasive grain
- Durable fibre backing
- An excellent starting point for stainless steel
- Includes a grinding aid for cooler running

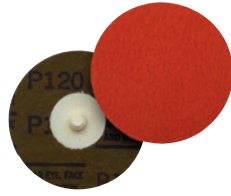

UPC	Diameter	Grade	Max. RPM	Min./Case
Roloc TR (Plastic Button) 				
051144-85882-8†	3"	24	20,000	50/100
051144-85883-5	3"	36	20,000	50/100
051144-85884-2	3"	50	20,000	50/100
051144-85885-9	3"	60	20,000	50/100
051144-85886-6	3"	80	20,000	50/100
051144-85887-3	3"	P100	20,000	50/200
051144-85888-0	3"	P120	20,000	50/200
051144-83690-1	4"	36	12,000	25/100
051144-83691-8	4"	50	12,000	25/100
051144-83692-5	4"	60	12,000	25/100
051144-83693-2	4"	80	12,000	25/100
051144-83694-9	4"	P100	12,000	25/100
051144-83695-6	4"	P120	12,000	25/100

† Made-to-Order

3M™ Roloc™ Cloth Disc 963G ■

- 3M ceramic abrasive grain
- Durable cloth backing



UPC	Diameter	Grade	Max. RPM	Min./Case
Roloc TR (Plastic Button) 				
051144-11422-1†	1"	50	30,000	50/500
051144-11428-3	1"	60	30,000	50/500
051144-11427-6	1"	80	30,000	50/500
051144-11425-2	1"	120	30,000	50/500
051144-11450-4	1-1/2"	36	30,000	50/500
051144-11448-1	1-1/2"	60	30,000	50/500
051144-11455-9	1-1/2"	80	30,000	50/500
051144-11454-2†	1-1/2"	100	30,000	50/500
051144-11453-5	1-1/2"	120	30,000	50/500
051144-11113-8	2"	24	25,000	50/200
051144-11112-1	2"	36	25,000	50/200
051144-76436-5	2"	40	25,000	50/200
051144-11111-4	2"	50	25,000	50/200
051144-11110-7	2"	60	25,000	50/200
051144-11109-1	2"	80	25,000	50/200
051144-11107-7	2"	100	25,000	50/200
051144-11106-0	2"	120	25,000	50/200
051144-11108-4	3"	24	20,000	50/200
051144-11105-3	3"	36	20,000	50/200
051144-11104-6	3"	50	20,000	50/200
051144-11103-9	3"	60	20,000	50/200
051144-11102-2	3"	80	20,000	50/200
051144-11101-5	3"	100	20,000	50/200
051144-11100-8	3"	120	20,000	50/200



† Made-to-Order

■ Mild Steel ■ Stainless Steel

3M™ Roloc™ Disc 977F ■

- 3M ceramic abrasive grain
- Features a grinding aid
- Excellent for stainless steel, titanium and high nickel alloys.





UPC	Diameter	Grade	Max. RPM	Min./Case
Roloc TR (Plastic Button) 				
051144-83587-4	2"	36	25,000	50/200
051144-83588-1	2"	60	25,000	50/200
051144-83589-8	2"	80	25,000	50/200
051144-83590-4†	3"	36	20,000	50/200
051144-83591-1	3"	60	20,000	50/200
051144-83592-8	3"	80	20,000	50/200
Roloc TSM (Metal Button) 				
051141-24005-3	1-1/2"	36	30,000	50/500
051141-24006-0	1-1/2"	60	30,000	50/500
051141-24003-9	2"	36	25,000	50/200
051141-24004-6	2"	60	25,000	50/200

† Made-to-Order

3M™ Roloc™ Discs 988R ■

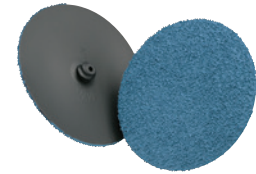
- 3M ceramic abrasive grain
- Cuts through metal stock to quickly level welds and take on tough jobs in small areas
- A unique single-piece construction that can eliminate button delamination and enhance disc performance





UPC	Diameter	Grade	Max. RPM	Min./Case
Roloc TR (Plastic Button) 				
051141-20626-4	2"	24	25,000	50/200
051141-20627-1	2"	36	25,000	50/200
051141-20628-8	2"	50	25,000	50/200
051141-20629-5	2"	60	25,000	50/200
051141-20630-1	2"	80	25,000	50/200
051141-20024-8	3"	24	20,000	50/200
051141-20025-5	3"	36	20,000	50/200
051141-20026-2	3"	50	20,000	50/200
051141-20030-9	3"	60	20,000	50/200
051141-20027-9	3"	80	20,000	50/200

Scotch-Brite™ Roloc™ SC Surface Conditioning Discs

- Scotch-Brite surface conditioning non-woven web provides a burr-free decorative finish
- Removes grind marks, rust and coatings
- Grade: A VFN – Blue; A MED – Maroon; A CRS – Brown





UPC	Diameter	Grade	Max. RPM	Min./Case
Roloc TP (Plastic Button) 				
048011-13237-2	2"	A CRS	25,000	50/200
048011-13241-9	3"	A CRS	18,000	25/100
048011-13243-3†	3"	A VFN	18,000	25/100
Roloc TR (Plastic Button) 				
048011-15393-3	1"	A CRS	30,000	200
048011-15392-6	1"	A MED	30,000	200
048011-15391-9	1"	A VFN	30,000	200
048011-15568-5†	1"	A SFN	30,000	200
048011-08764-1	1-1/2"	A CRS	30,000	50/200
048011-08765-8	1-1/2"	A MED	30,000	50/200
048011-08766-5	1-1/2"	A VFN	30,000	50/200
048011-08767-2†	1-1/2"	A SFN	30,000	50/200
048011-05528-2	2"	A CRS	25,000	50/200
048011-05527-5	2"	A MED	25,000	50/200
048011-05522-0	2"	A SFN	25,000	50/200
048011-05523-7	2"	A VFN	25,000	50/200
048011-05532-9	3"	A CRS	18,000	25/100
048011-05531-2	3"	A MED	18,000	25/100
048011-05529-9	3"	A SFN	18,000	25/100
048011-05530-5	3"	A VFN	18,000	25/100
048011-12954-9	4"	A CRS	12,000	25/100
048011-12953-2	4"	A MED	12,000	25/100
048011-12951-8†	4"	A SFN	12,000	100
048011-12952-5	4"	A VFN	12,000	25/100
Roloc TSM (Metal Button) 				
048011-13249-5†	1-1/2"	A CRS	30,000	50/200
048011-25775-4	1-1/2"	A CRS	30,000	50/200
048011-25774-7†	1-1/2"	A MED	30,000	50/200
048011-25773-0†	1-1/2"	A VFN	30,000	50/200
048011-25765-5	2"	A CRS	25,000	50/200
048011-25764-8	2"	A MED	25,000	50/200
048011-25770-9	2"	A VFN	25,000	50/200
048011-25767-9	3"	A CRS	18,000	25/100
048011-13257-0	3"	A CRS	18,000	25/100
048011-25766-2	3"	A MED	18,000	25/100
048011-13258-7	3"	A MED	18,000	25/100
048011-25780-8	3"	A VFN	18,000	25/100
048011-13259-4	3"	A VFN	18,000	25/100
048011-13260-0†	3"	A SFN	18,000	25/100

† Made-to-Order

Scotch-Brite™ Roloc™ SE Surface Conditioning Discs

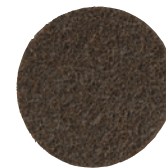
- This coarse, tough, aggressive non-woven disc is ideal for heavy-duty deburring and finishing



UPC	Diameter	Grade	Max. RPM	Min./Case
Roloc TR (Plastic Button) 				
048011-18081-6	2"	A CRS	25,000	50/200
048011-18471-5	2"	A MED	25,000	50/200
048011-30005-4	2"	A FIN	25,000	50/200
048011-18082-3	3"	A CRS	18,000	25/100
048011-18472-2	3"	A MED	18,000	25/100
048011-93453-2	3"	A FIN	18,000	25/100

Scotch-Brite™ Roloc™ SL Surface Conditioning Discs

- Cuts fast without sacrificing finish
- Can last up to twice as long as other surface conditioning discs
- Delivers outstanding value and productivity improvement



UPC	Diameter	Grade	Max. RPM	Min./Case
Roloc TR (Plastic Button) 				
048011-33797-5	2"	A CRS SD	25,000	200
048011-33795-1	2"	A CRS HD	25,000	200
048011-33796-8	3"	A CRS SD	18,000	100
048011-33794-4	3"	A CRS HD	18,000	100

Many other sizes available upon request.

Scotch-Brite™ Roloc™ PD Surface Conditioning Discs

- Lofty, open non-woven abrasive disc
- Resistant to loading on soft metals and oily surfaces



UPC	Diameter	Grade	Max. RPM	Min./Case
Roloc TR (Plastic Button) 				
048011-60191-5†	2"	A CRS	25,000	50/200
048011-24287-3	2"	A MED	25,000	50/200
048011-60192-2	3"	A CRS	18,000	25/100
048011-24295-8	3"	A MED	18,000	25/100



† Made-to-Order

Scotch-Brite™ Roloc™ Discs

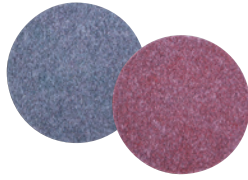
Scotch-Brite™ Roloc™ Light Grinding and Blending Discs



- 3M ceramic aluminum oxide blend abrasive grain
- Resists edge wear
- Great for light grinding, deburring and blending on all metals
- Super Duty: Blue
- Heavy Duty: Maroon

UPC	Diameter	Grade	Max. RPM	Qty./Case
Roloc TR (Plastic Button) 				
048011-60355-1	2"	A CRS SD	25,000	50/200
048011-60354-4	2"	A CRS HD	25,000	50/200
048011-60357-5	3"	A CRS SD	18,000	25/100
048011-60356-8	3"	A CRS HD	18,000	25/100
048011-60359-9	4"	A CRS SD	12,000	25/100
048011-60358-2	4"	A CRS HD	12,000	25/100
Roloc TSM (Metal Button) 				
048011-60375-9	2"	A CRS SD	25,000	50/200
048011-60374-2	2"	A CRS HD	25,000	50/200
048011-60377-3	3"	A CRS SD	18,000	100
048011-60376-6†	3"	A CRS HD	18,000	100

† Made-to-Order

Scotch-Brite™ Roloc™ Clean and Strip Discs



- Aggressively removes paint, rust and seam sealers
- Open web construction for cool running and resistance to loading and smearing
- Faster cutting than wire brushes and wheels to increase production

UPC	Size	Grade	Max. RPM	Qty./Case
048011-14784-0	4" x 1"	S XCS	8,000	10
048011-14780-2	4" x 1" x 1/4"	S XCS	8,000	10

Scotch-Brite™ Roloc™ Clean and Strip XT Disc





- Silicon carbide mineral
- Durable, rigid, long lasting
- Aggressive, open-web disc for cleaning welds, removing rust and paint

UPC	Diameter	Grade	Max. RPM	Min./Case
Roloc TR (Plastic Button) 				
048011-30147-1	2" x NH	S XCS	18,000	60
048011-30016-0	3" x NH	S XCS	15,000	40

Scotch-Brite™ Roloc™ HS Blend and Finish



- Aluminum oxide mineral
- New high strength nonwoven with superior durability and cut
- Great flexibility and conformability for weld burn removal, light deburring, blending, finishing and rust removal

UPC	Diameter	Grade	Max. RPM	Min./Case
Roloc TR (Plastic Button) 				
048011-64190-4	2"	A MED	18,000	200
048011-64206-2	3"	A MED	15,000	100
Roloc TSM (Metal Button) 				
048011-64213-0	2"	A MED	18,000	200
048011-64220-8	3"	A MED	15,000	100



Scotch-Brite™ Roloc™ Discs

Scotch-Brite™ Roloc™ Bristle Discs

- Efficiently clean and strip many substances from metal surfaces without damaging the work piece
- An operator can quickly and easily achieve a quality, consistent finish with light pressure



UPC	Size	Grade	Color	Max. RPM	Min./Case
Roloc TR (Plastic Button) 					
048011-18698-6	1"	50	Green	30,000	20/80
048011-18706-8	1"	80	Yellow	30,000	20/80
048011-18710-5	1"	120	White	30,000	20/80
048011-18730-3	2"	50	Green	25,000	10/40
048011-18732-7	2"	80	Yellow	25,000	10/40
048011-18733-4	2"	120	White	25,000	10/40
048011-18734-1	3"	50	Green	15,000	10/40
048011-18736-5	3"	80	Yellow	15,000	10/40
048011-18737-2	3"	120	White	15,000	10/40

Scotch-Brite™ Roloc™ Body Man's Bristle Disc

- Contains 3M ceramic aluminum oxide blend abrasive grain
- Removes high loading materials fast and doesn't load
- Great for removing rubberized undercoating, seam sealer, rust and paint
- Maintains high quality product life



UPC	Diameter	Grade	Max. RPM	Min./Case
051131-07540-5	1"	36	30,000	6/36
051131-07536-8	2"	36	25,000	4/24
051131-07537-5	3"	36	18,000	3/18

Scotch-Brite™ Roloc™ Coating Removal Discs

- Extra coarse grade silicon carbide
- Heavy duty, semi-open web used to clean rust and paint
- Color: Black



UPC	Diameter	Grade	Max. RPM	Min./Case
048011-18364-0	2"	S XCS	18,000	60
048011-18350-3	3"	S XCS	15,000	40
048011-18470-8	4"	S XCS	11,000	40

Scotch-Brite™ Roloc™ EXL Unitized Wheels

- Strong, efficient products for edge deburring and finishing
- Used with 3M™ Roloc™ or 3M™ Roloc™+ holder pads on a straight shaft or right-angle tool





UPC	Diameter	Grade	Max. RPM	Qty./Case
Roloc TR (Plastic Button) 				
048011-17185-2	2"	2A MED	22,100	60
048011-17183-8	2"	2S FIN	22,100	60
048011-17190-6	2"	6A MED	22,100	60
048011-17192-0	2"	8A MED	22,100	60
048011-17186-9	3"	2A MED	15,100	40
048011-17184-5	3"	2S FIN	15,100	40
048011-17191-3	3"	6A MED	15,100	40
048011-17193-7	3"	8A MED	15,100	40

Scotch-Brite™ Roloc™ Rapid Cut Unitized Wheels

NEW!

- Non-woven abrasive wheels utilizing 3M precision shaped ceramic grain for higher levels of cut while maintaining a consistent finish
- Recommended for deburring and weld blending on all metals
- Quick change Roloc™ Attachment





UPC	Size	Grade	Max. RPM	Qty./Case
Roloc TR (Plastic Button) 				
051115-66759-6	2" x NH	9C CRS+	22,100	15/60
048011-64859-0	3" x NH	9C CRS+	15,100	10/40
051115-66760-2	3" x NH	9C XCS+	15,100	10/40
Roloc TS (Plastic Button) 				
051115-66763-3	2" x NH	9C CRS+	22,100	15/60
051115-66764-0†	3" x NH	9C XCS+	15,100	10/40

Roloc™ D/F Discs

3M™ Roloc™ D/F Discs 361F

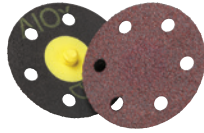
- Aluminum oxide mineral coated on a YF wt. cloth backing.
- For general purpose grinding, blending and finishing on all metals.
- D/F construction provides cool running, dust control.
- Quick change Roloc™ attachment.





UPC	Diameter	Grade	Max. RPM	Min./Case
Roloc TR (Plastic Button) 				
051141-28042-4	2" x 4 holes	36	25,000	50/200
051141-28046-2	2" x 4 holes	60	25,000	50/200
051141-28050-9	2" x 4 holes	80	25,000	50/200
051141-28053-0	2" x 4 holes	120	25,000	50/200
051141-28044-8	3" x 6 holes	36	20,000	50/200
051141-28048-6	3" x 6 holes	60	20,000	50/200
051141-28052-3	3" x 6 holes	80	20,000	50/200
051141-28056-1	3" x 6 holes	120	20,000	50/200
Roloc TSM (Metal Button) 				
051141-28041-7	2" x 4 holes	36	25,000	50/200
051141-28045-5	2" x 4 holes	60	25,000	50/200
051141-28049-3	2" x 4 holes	80	25,000	50/200
051141-28054-7	2" x 4 holes	120	25,000	50/200
051141-28043-1	3" x 6 holes	36	20,000	50/200
051141-28047-9	3" x 6 holes	60	20,000	50/200
051141-28051-6	3" x 6 holes	80	20,000	50/200
051141-28055-4	3" x 6 holes	120	20,000	50/200

3M™ Roloc™ D/F Discs 777F

- 3M ceramic abrasive grain on YF wt. polyester cloth backing.
- Fast cutting, long lasting disc for grinding, blending and finishing all types of metal.
- D/F construction for dust control and cool running.
- Quick change Roloc™ attachment.





UPC	Diameter	Grade	Max. RPM	Min./Case
Roloc TR (Plastic Button) 				
051141-28058-5	2" x 4 holes	36	25,000	50/200
051141-28062-2	2" x 4 holes	60	25,000	50/200
051141-28066-0	2" x 4 holes	80	25,000	50/200
051141-28070-7	2" x 4 holes	120	25,000	50/200
051141-28060-8	3" x 6 holes	36	20,000	50/200
051141-28064-6	3" x 6 holes	60	20,000	50/200
051141-28068-4	3" x 6 holes	80	20,000	50/200
051141-28072-1	3" x 6 holes	120	20,000	50/200
Roloc TSM (Metal Button) 				
051141-28057-8	2" x 4 holes	36	25,000	50/200
051141-28061-5	2" x 4 holes	60	25,000	50/200
051141-28065-3	2" x 4 holes	80	25,000	50/200
051141-28069-1	2" x 4 holes	120	25,000	50/200
051141-28059-2	3" x 6 holes	36	20,000	50/200
051141-28063-9	3" x 6 holes	60	20,000	50/200
051141-28067-7	3" x 6 holes	80	20,000	50/200
051141-28071-4	3" x 6 holes	120	20,000	50/200

3M™ Cubitron™ II Roloc™ Durable Edge D/F Discs 984F

- 3M precision shaped ceramic grain on a reinforced cloth backing.
- Designed for heavy-duty metalworking applications such as weld grinding, beveling and flame-out edge clean-up.
- Super-fast cut, long life on stainless steel and carbon steel.
- D/F construction for dust control.
- Convenient quick change Roloc™ attachment.





UPC	Diameter	Grade	Max. RPM	Min./Case
Roloc TR (Plastic Button) 				
051141-28073-8	2" x 4 holes	36+	25,000	50/200
051141-28077-6	2" x 4 holes	60+	25,000	50/200
051141-28080-6	2" x 4 holes	80+	25,000	50/200
051141-28076-9	3" x 6 holes	36+	20,000	50/200
051141-28084-4	3" x 6 holes	60+	20,000	50/200
051141-28082-0	3" x 6 holes	80+	20,000	50/200
Roloc TSM (Metal Button) 				
051141-28074-5	2" x 4 holes	36+	25,000	50/200
051141-28078-3	2" x 4 holes	60+	25,000	50/200
051141-28079-0	2" x 4 holes	80+	25,000	50/200
051141-28075-2	3" x 6 holes	36+	20,000	50/200
051141-28083-7	3" x 6 holes	60+	20,000	50/200
051141-28081-3	3" x 6 holes	80+	20,000	50/200

Scotch-Brite™ Roloc™ SC Surface Conditioning D/F Discs

- Non-woven abrasive product used for cleaning, finishing, blending and deburring applications
- Threaded attachment system secures the disc to the holder



UPC	Diameter	Grade	Max. RPM	Min./Case
Roloc TR (Plastic Button) 				
048011-64674-9	2" x 4 holes	A VFN	25,000	50/200
048011-64675-6	2" x 4 holes	A MED	25,000	50/200
048011-64676-3	2" x 4 holes	A CRS	25,000	50/200
048011-64679-4	3" x 6 holes	A VFN	18,000	25/100
048011-64678-7	3" x 6 holes	A MED	18,000	25/100
048011-64677-0	3" x 6 holes	A CRS	18,000	25/100
Roloc TSM (Metal Button) 				
048011-64683-1	2" x 4 holes	A CRS	25,000	50/200

3M™ Roloc™ Dust Shroud Kits

- Use with 0.3 HP and 0.5 HP 3M™ Disc Sanders (12,000 RPM)
- Considered to be an "engineered control" when used with approved vacuum systems



UPC	Size	Qty./Case
051141-28727-0	2"	1
051141-28728-7	3"	1

3M™ Roloc™ Disc Intro Pack 9815S, 982S and 983S



- Contains the following assortment of 3M's top selling Roloc™ Discs:
 - 3M™ Cubitron™ II Roloc™ Durable Edge Disc 984F (3 of each grade: 36+, 60+, 80+)
 - Scotch-Brite™ Roloc™ SC Surface Conditioning Disc (2 of each grade: A VFN, A MED, A CRS)
 - Scotch-Brite™ Roloc™ Light Grinding and Blending Disc (2 of each grade: SD ACRS)
- Contains 1 each of the following:
 - 3M™ Roloc™ Disc Pad TR (Hard)
 - 3M™ Roloc™ Shank

UPC	Part No.	Size	Min./Case
051144-82901-9	9815S	1-1/2"	5 packs/case
051144-82899-9	982S	2"	5 packs/case
051144-82900-2	983S	3"	5 packs/case

3M™ Roloc™ Disc Intro Pack 985S



- Contains the following assortment of 3M's top selling Roloc™ Discs:
 - 2" Scotch-Brite™ Roloc™ SC Surface Conditioning Disc (2 of each grade: A VFN, A MED, A CRS)
 - 3" Scotch-Brite™ Roloc™ SC Surface Conditioning Disc (2 of each grade: A VFN, A MED, A CRS)
 - 2" Scotch-Brite™ Roloc™ Light Grinding and Blending Disc (2 of each grade: SD ACRS)
 - 3" Scotch-Brite™ Roloc™ Light Grinding and Blending Disc (2 of each grade: SD ACRS)
- Contains 1 each of the following:
 - 3M™ Roloc™ Disc Pad 2" and 3" (Hard)
 - 3M™ Roloc™ Shank

UPC	Part No.	Size	Min./Case
048011-18254-4	985S	2" and 3"	5 packs/case

3M™ Roloc™ Disc Intro Pack 984S



- Contains the following assortment of 3M's top selling Roloc™ Discs:
 - 3M™ Cubitron™ II Roloc™ Durable Edge Disc 984F (3 of each grade: 36+, 60+, 80+)
 - Scotch-Brite™ Roloc™ SC Surface Conditioning Disc (2 of each grade: A VFN, A MED, A CRS)
 - Scotch-Brite™ Roloc™ Light Grinding and Blending Disc (2 of each grade: SD A CRS)
- Contains 1 each of the following:
 - 3M™ Roloc™ Disc Pad TR (Extra Hard)
 - 3M™ Spacer (PN28636)

UPC	Part No.	Size	Min./Case
051141-28039-4	984S	4"	5 packs/case

3M™ Roloc™ Bristle Disc Pack 983BS



- Contains a variety of grades of 3M™ Roloc™ Bristle Discs 3" diameter x 5/8" trim
- Includes a disc pad holder

UPC	Size	Min./Case
048011-18697-9	3"	1/5

3M™ Power Tools for Roloc™ Discs

3M™ Disc Sanders

- Versatile, durable, comfortable and powerful
- Features 3M™ Gripping Material
- 97° head for decreased wrist strain
- Use with 3M™ and Scotch-Brite™ Abrasive Discs and Disc Accessories
- For a variety of metalworking applications



Model No.	Tool Dia. Inch (mm)	Motor HP (W)	Max RPM	Weight Pound (kg)	Length Inch (mm)	Height Inch (mm)	Air Inlet Thread	Airflow Rate SCFM (LPM)	Exhaust Direction	UPC
28328	2 (51)	0.3 (224)	12,000	1.09 (.49)	5.91 (150.2)	2.5 (63.5)	1/4" NPT	17 (481)	Rear Directional	051141-28328-9
28329	2 (51)	0.5 (372)	12,000	1.28 (.58)	6.75 (171.5)	2.75 (69.9)	1/4" NPT	26 (736)	Rear Directional	051141-28329-6
28341	2 (51)	0.3 (224)	20,000	1.09 (.49)	5.91 (150.2)	2.5 (63.5)	1/4" NPT	17 (481)	Rear Directional	051141-28341-8
20231	2 (51)	0.5 (372)	20,000	1.28 (.58)	6.75 (171.5)	2.75 (69.9)	1/4" NPT	26 (736)	Rear Directional	051141-20231-0
20232	3 (76)	1 (744)	15,000	1.97 (.89)	8.25 (209.6)	3.25 (82.6)	1/4" NPT	37 (1,048)	Rear Directional	051141-20232-7
28408	4-5 (100-127)	1 (744)	12,000	2.31 (1.05)	8.25 (209.6)	4.23 (107.4)	3/8" NPT*	37 (1,048)	Rear	051141-28408-8
28622	4-5 (100-127)	1 (744)	12,000	4.03 (1.83)	11.5 (292)	4.70 (119)	3/8" NPT*	37 (1,048)	—	051141-28622-8

*Includes 3/8" to 1/4" reducer

3M™ Pistol Grip Rotary Disc Sander

- Designed for light duty applications



Model No.	Description	Tool Dia. Inch (mm)	Motor HP (W)	Max RPM	Weight Pound (kg)	Length Inch (mm)	Height Inch (mm)	Airflow Rate SCFM (LPM)	Thread Size	UPC
28547	Rotary	3 (76)	0.45 (336)	15,000	1.79 (0.81)	4.8 (122)	5.35 (136)	23 (651)	1/4-20 EXT	051141-28547-4

3M™ Pistol Grip Random Orbital Disc Sander

- Powerful, lightweight tool with excellent balance
- Durable composite body for ergonomic feel
- Pistol grip design allows you to sand in hard-to-reach areas



Model No.	Tool Dia. Inch (mm)	Motor HP (W)	Max RPM	Orbit Dia. Inch (mm)	Weight Pound (kg)	Length Inch (mm)	Height Inch (mm)	Airflow Rate SCFM (LPM)	Thread Size	UPC
38353	3 (76)	0.45 (336)	15,000	1/8 (3.2)	1.8 (0.8)	5 (122)	5 (136)	22 (623)	5/16-24 EXT	051141-28353-1

3M™ Elite Series Mini Orbital Sander

- Designed for sanding nibs or defects on the clearcoat, used with 3M™ Trizact™ Finesse-it™ Film Disc 466LA
- 3M™ Gripping Material for added comfort and reduced vibration
- Provides optimal uniform sanding scratches with a superior finish



Model No.	Tool Dia. Inch (mm)	Motor HP (W)	Max RPM	Orbit Dia. Inch (mm)	Weight Pound (kg)	Length Inch (mm)	Height Inch (mm)	Airflow Rate SCFM (LPM)	Pad Included	UPC
28737	1-1/4 x 3/16	0.48 (357)	8,000	1/8 (3.2)	1.33 (0.6)	7.6 (193)	4.1 (103)	23 (651)	Roloc™ 02345 w/Stikit™ Face	051141-28737-9



3M™ Mini-Random Orbital Sander

- Lightweight sander for use with the 3M™ Trizact™ Finesse-it™ Paint Repair System
- Unique one-piece shaft balancer system supports the low profile design and improved control





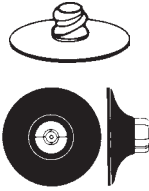

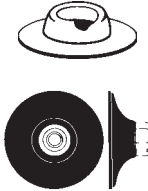

Model No.	Tool Dia. Inch (mm)	Motor HP (W)	Max RPM	Orbit Dia. Inch (mm)	Weight Pound (kg)	Length Inch (mm)	Height Inch (mm)	Airflow Rate SCFM (LPM)	Pad Included	UPC
20244	1-1/4 x 3/16	.27 (201)	8,000	3/16 (5)	1.10 (.498)	4.72 (120)	3.32 (84.5)	15 (425)	Roloc™ 02345 w/Stikit™ Face	051141-20244-0

Accessories for Roloc™ Systems

Product Name	UPC	Qty./Case	For Use With	Size/Description	Max RPM
3M™ Roloc™ TR Disc Pads 	051144-45101-2	5	3M™ Roloc™ TR Discs	1" Diameter; Medium; 1/4–20 INT	30,000
	051144-45099-2	5		1-1/2" Diameter; Medium; 1/4–20 INT	30,000
	051144-45100-5	5		1-1/2" Diameter; Hard; 1/4–20 INT	30,000
	051144-45095-4	5		2" Diameter; Medium; 1/4–20 INT	25,000
	051144-45096-1	5		2" Diameter; Hard; 1/4–20 INT	25,000
	051144-45097-8	5		2" Diameter; Extra Hard; 1/4–20 INT	25,000
	051144-45092-3	5		3" Diameter; Medium; 1/4–20 INT	18,000
	051144-45091-6	5		3" Diameter; Hard; 1/4–20 INT	20,000
	051144-45093-0	5		3" Diameter; Extra Hard; 1/4–20 INT	20,000
	051144-45179-1	5		4" Diameter; Medium; 1/4–20 INT	12,000
	051141-28474-3	5		4" Diameter; Hard; 3/8–24 INT	12,000
	051141-28475-0	5		4" Diameter; Extra Hard; 3/8–24 INT	12,000
	051144-83242-2	5		4" Diameter; Medium; 5/8–11 INT	12,000
	051144-83489-1	5		4" Diameter; Hard; 5/8–11 INT	12,000
	051144-83980-3	5		4" Diameter; Extra Hard; 5/8–11 INT	12,000
3M™ Roloc™ Cool Running Disc Pads 	051144-82974-3	5	3M™ Roloc™ TR Discs	2" Diameter; Medium; 1/4–20 INT	20,000
	051141-28711-9	5		2" Diameter; Hard; 1/4–20 INT	20,000
	051144-82975-0	5		3" Diameter; Medium; 1/4–20 INT	12,000
	051141-28710-2	5		3" Diameter; Hard; 1/4–20 INT	12,000
	051111-56479-0	5		4" Diameter; Hard; 3/8–24 INT	15,000
	051141-28473-6	5		4" Diameter; Hard; 5/8–11 INT	15,000
3M™ Roloc™ TS or TSM Disc Pads 	051144-77729-7	5	3M™ Roloc™ TSM Discs and "screw on" abrasive discs	1-1/2" Diameter; Medium; 1/4–20 INT	30,000
	051144-77728-0	5		1-1/2" Diameter; Hard; 1/4–20 INT	30,000
	051144-14211-8	5		2" Diameter; Medium; 1/4–20 INT	25,000
	051144-14212-5	5		2" Diameter; Hard; 1/4–20 INT	25,000
	051144-14215-6	5		3" Diameter; Medium; 1/4–20 INT	18,000
	051144-14216-3	5		3" Diameter; Hard; 1/4–20 INT	20,000
	051144-28578-8	5		4" Diameter; Hard; 5/8–11 INT	12,000
	051144-28579-5	5		4" Diameter; Extra Hard; 5/8–11 INT	12,000
3M™ Roloc™ TP Disc Pads	051144-14201-9	5	3M™ Roloc™ TP Discs	3"; Medium; 1/4–20 INT	18,000
	051144-14202-6	5	3M™ Roloc™ TP Discs	3"; Hard; 1/4–20 INT	20,000

Accessories for Roloc™ Systems

Product Name	UPC	Qty./Case	For Use With	Size/Description	Max RPM
1/4" Threaded Shaft 	051144-45102-9	10/50	3M™ Roloc™ Disc Pads with 1/4–20 INT	1/4" x 1/4–20 Thread	N/A
3M™ Roloc™ + Holder 	048011-15408-4	5	3M™ Roloc™ Unitized Wheels, Roloc™+ Products, Brush and Disc Accessories	1" Diameter x 1/4" Shaft Diameter	25,000
3M™ Roloc™ Dust Shroud Kits 	051141-28727-0	1	3M™ Disc Sanders (0.3 HP and 0.5 HP); 3M™ Roloc™ D/F Discs (2" and 3")	2"	12,000
	051141-28728-7	1		3"	12,000
3M™ Vacuum Hose Anti-Static 	051141-28730-0	1	Used to connect Random Orbital and Orbital Sanders to a vacuum system	1" ID x 4 ft. Length, 1" EXT Hose Thread	N/A
3M™ Overhose Kit 	051141-28651-8	1	0.3 HP Die Grinders	Kit Contains: Air Line Extension (PN 20209), Adapter (PN 20453), Over Hose Cloth Sleeve, Exhaust Spacer, Air Inlet Bushing, Instruction Sheet	N/A

Random Orbital Systems



3M™ Abrasive Discs for Random Orbital Sanding

3M™ Stikit™ and PSA Discs are designed to handle a wide range of sanding and finishing needs. These discs have a pressure sensitive adhesive coating on the back side for easy application and clean removal.

Scotch-Brite™ Random Orbital (RO) Discs are engineered to give you a faster-cutting, longer-lasting and more consistent alternative to paper and cloth-back coated abrasives on applications like prepping bare metal for painting. These innovative discs are constructed especially for random orbital sanders, using a non-woven nylon web embedded with premium ceramic grain. The result is a longer-lasting disc that offers a quicker initial cut than most coated abrasives designed for random orbital sanders — plus a more consistent finish from beginning to end.

3M™ and Scotch-Brite™ Disc Selection Guide

Product	Anti-Loading	Backing	Performance	Application		Metal Type						
				Blending	Finishing	Stainless Steel	Aluminum	Carbon Steel	Titanium	Nickel Alloy	Non-Ferrous (Brass Bronze)	
NX	Yes	C & D wt. Paper	Good	■	■	■	■	■				
341D	—	X wt. Cloth	Good	■	■		■	■				■
236U	Yes	C wt. Paper	Better	□	□		□	□				
426U	Yes	A wt. Paper	Better		□	□	□	□				
363I	—	F wt. Paper	Better	□	□		□	□				
202DZ	—	J wt. Cloth	Better	□	□		□					□
348D	—	X wt. Cloth	Better	□			□	□				
735U	Yes	C wt. Paper	Best	■	■		■	■				
763U	—	F wt. Paper	Best	■	■	■	■	■				
777F	—	Y wt. Cloth	Best	■	■	■		■	■	■		
900DZ	—	J wt. Cloth	Best	■	■		■					
Scotch-Brite™ RO	—	Nylon	Best	■	■	■	■	■	■	■		■

Scotch-Brite™ Discs — Hook-and-Loop

Scotch-Brite™ RO Discs



- Premium ceramic grain abrasive discs designed especially for random orbital sanders
- Fast cut rate — less pressure required
- Extremely long life for fewer disc changes
- Ideal for prepping bare metal for paint
- Use with 3M™ Hookit™ Low Profile Disc Pads (PNs 20352 and 20355)

UPC	Diameter	Grade	Color	Min./Case
048011-64694-7	5"	FIN	Green	100
048011-64693-0	5"	MED	Maroon	100
048011-64756-2	5"	CRS	Brown	100
048011-64795-4	6"	FIN	Green	100
048011-64796-1	6"	MED	Maroon	100
048011-64757-9	6"	CRS	Brown	100

* Available in dust-free configuration

Scotch-Brite™ Pads

Scotch-Brite™ Discs 7447 PRO



The fast, consistent performance of Scotch-Brite™ 7447 PRO can help reduce surface prep time on a variety of applications including:

- Paint and primer preparation on airplanes, cars, trucks and other motor vehicles
- Scuff sanding of sealer coatings on cabinetry and furniture
- Refine finishes on stainless steel appliances, food processing, pharmaceutical and surgical equipment

UPC	Size	Grade	Color	Min./Case
Discs				
048011-64959-7	5" Dia.	A VFN	Maroon	100
048011-64960-3	6" Dia.	A VFN	Maroon	100
Jitterbug Sheet Pad				
048011-64958-0	3-2/3" x 9-1/4"	A VFN	Maroon	100

3M™ Stikit™ Discs

3M™ Stikit™ Disc 202DZ

- Aluminum oxide on a durable J wt. cloth backing
- Excellent for use on aluminum and brass
- Open coat resists loading
- Individual discs with liners



UPC	Diameter	Grade	Min./Case
Paper Backing			
051111-50450-5	5"	80	50/250
051111-50451-2	5"	P100	50/250
051111-50452-9	5"	P120	50/250
051111-50453-6	5"	P150	50/250
051111-50454-3	5"	P180	50/250
051111-50455-0	5"	P220	50/250
051111-50459-8	6"	80	50/250
051111-50460-4	6"	P100	50/250
051111-50461-1	6"	P120	50/250
051111-50462-8	6"	P150	50/250
051111-50463-5†	6"	P180	50/250
051111-50464-2	6"	P220	50/250

† Made-to-Order

3M™ NX Disc Roll

- Aluminum oxide on a C wt. (P100–P400) or D wt. (40, P60, P80) paper backing
- Load resistant coating
- Excellent for sanding on whitewood, primer, paint sealers and topcoats



UPC	Diameter	Grade	Min./Case
Paper Backing			
051141-31181-4	5" x NH	P80	100/4
051141-31182-1	5" x NH	P100	100/4
051141-31183-8	5" x NH	P120	100/4
051141-31184-5	5" x NH	P150	100/4
051141-31185-2	5" x NH	P180	100/4
051141-31186-9	5" x NH	P220	100/4
051141-27672-4	5" x NH	P240	100/4
051141-27674-8	5" x NH	P320	100/4
051141-27676-2	5" x NH	P400	100/4
051141-31189-0	6" x NH	P80	100/4
051141-31190-6	6" x NH	P100	100/4
051141-31191-3	6" x NH	P120	100/4
051141-31192-0	6" x NH	P150	100/4
051141-31193-7	6" x NH	P180	100/4
051141-31194-4	6" x NH	P220	100/4
051141-27673-1	6" x NH	P240	100/4
051141-27675-5	6" x NH	P320	100/4
051141-27677-9	6" x NH	P400	100/4

3M™ NX Disc

- Aluminum oxide on a D wt. paper backing
- Load resistant coating
- Excellent for sanding on whitewood, primer, paint sealers and topcoats



UPC	Diameter	Grade	Min./Case
Paper Backing with Tabbed Liner			
051141-31211-8	5" x NH	40	50/250
051141-31212-5	5" x NH	P60	50/250
051141-31219-4	6" x NH	40	50/250
051141-31220-0	6" x NH	P60	50/250

3M™ Stikit™ Disc Roll 236U

- Premium aluminum oxide on a C wt. paper backing
- Discs for paint, primer, wood, metal, plastic and fiberglass
- Strong paper backing provides durability and increased cut rate
- Open coat minimizes loading
- Load resistant coating



UPC	Diameter	Grade	Discs/Roll	Qty./Case
Paper Backing				
051141-55540-9	5"	P80	100	4
051141-55541-6	5"	P100	100	4
051141-55542-3	5"	P120	100	4
051141-55543-0	5"	P150	100	4
051141-55544-7	5"	P180	100	4
051141-55545-4	5"	P220	100	4
051141-55546-1	5"	P240	100	4
051141-55547-8	5"	P320	100	4
051141-55548-5	5"	P400	100	4
051141-55549-2	5"	P500	100	4
051141-55560-7	6"	P80	100	4
051141-55561-4	6"	P100	100	4
051141-55562-1	6"	P120	100	4
051141-55563-8	6"	P150	100	4
051141-55564-5	6"	P180	100	4
051141-55565-2	6"	P220	100	4
051141-55566-9	6"	P240	100	4
051141-55567-6	6"	P320	100	4
051141-55568-3	6"	P400	100	4
051141-55569-0	6"	P500	100	4

3M™ Stikit™ Discs

3M™ Stikit™ Disc Roll 341D

- Aluminum oxide on a durable X wt. cloth backing
- Resin bonded for heat resistance



UPC	Diameter	Grade	Discs/Roll	Qty./Case
Paper Backing				
051144-21752-6	5" X NH	50	100	4
051144-21751-9	5" X NH	60	100	4
051144-21750-2	5" X NH	80	100	4
051144-21749-6	5" X NH	P100	100	4
051144-21748-9	5" X NH	P120	100	4
051144-21746-5	5" X NH	P180	100	4
051144-21762-5	6" X NH	60	100	4
051144-21761-8	6" X NH	80	100	4

3M™ Stikit™ Disc Roll 363I

- Aluminum oxide on an extra heavy F wt. paper backing
- Resin bonded for heat resistance



UPC	Diameter	Grade	Discs/Roll	Qty./Case
Paper Backing				
051144-21800-4	5" x NH	60	100	4
051144-21799-1	5" x NH	80	100	4
051144-21798-4	5" x NH	P100	100	4
051144-21797-7	5" x NH	P120	100	4
051144-21796-0	5" x NH	P150	100	4
051144-21795-3	5" x NH	P180	100	4
051144-21794-6	6" x NH	60	100	4
051144-21793-9	6" x NH	80	100	4
051144-21792-2	6" x NH	P100	100	4
051144-21791-5	6" x NH	P120	100	4
051144-21790-8	6" x NH	P150	100	4
051144-21789-2	6" x NH	P180	100	4

3M™ Stikit™ Film Disc Roll 375L



- Durable film construction provides tear resistant properties
- Premium abrasive and load resistant coating provide fast cut and long life
- Flexible, smooth film backing conforms to contours and rounded edges
- Produces a uniform and consistent finish because of the flatness of the film backing

UPC	Diameter	Grade	Min./Case
051115-66793-0	5" x NH	P80	100/4
051115-66794-7	5" x NH	P100	100/4
051115-66795-4	5" x NH	P120	100/4
051115-66796-1	5" x NH	P150	100/4
051115-66797-8	5" x NH	P180	100/4
051115-66798-5	5" x NH	P220	100/4
051115-66799-2	5" x NH	P240	100/4
051115-66800-5	5" x NH	P280	100/4
051115-66801-2	5" x NH	P320	100/4
051115-66802-9	5" x NH	P400	100/4
051115-66803-6	6" x NH	P80	100/4
051115-66804-3	6" x NH	P100	100/4
051115-66805-0	6" x NH	P120	100/4
051115-66806-7	6" x NH	P150	100/4
051115-66807-4	6" x NH	P180	100/4
051115-66808-1	6" x NH	P220	100/4
051115-66809-8	6" x NH	P240	100/4
051115-66810-4	6" x NH	P280	100/4
051115-66811-1	6" x NH	P320	100/4
051115-66812-8	6" x NH	P400	100/4

Tech Tip

3M™ Disc Finish and Life — comparing grade 180

Best Finish (fewest swirl marks)

Longest Life (related to mineral dulling)

↑
426U
NX
236U
375L
363I
735U
Scotch-Brite™ R0
763U
202DZ
341D
900DZ
↓
Coarsest Finish

↑
900DZ
777F
Scotch-Brite™ R0
341D
202DZ
763U
735U
363I
375L
236U
NX
426U
↓
Least Life



3M™ Stikit™ Discs

3M™ Stikit™ Disc Roll 426U

- Silicon carbide abrasive on a flexible A wt. paper backing
- Features a load resistant coating
- Delivers good cut and excellent finish



UPC	Diameter	Grade	Discs/Roll	Qty./Case
051141-27775-2	5" x NH	80	125	10
051141-27776-9	5" x NH	100	125	10
051141-27777-6	5" x NH	120	125	10
051141-27778-3	5" x NH	150	175	6
051141-27779-0	5" x NH	180	175	6
051141-27780-6	5" x NH	220	175	6
051141-27781-3	5" x NH	240	175	6
051141-27782-0	5" x NH	280	175	6
051141-27783-7	5" x NH	320	175	6
051141-27784-4	5" x NH	400	175	6
051141-27785-1	6" x NH	80	125	10
051141-27786-8	6" x NH	100	125	10
051141-27787-5	6" x NH	120	125	10
051141-27788-2	6" x NH	150	175	6
051141-27789-9	6" x NH	180	175	6
051141-27790-5	6" x NH	220	175	6
051141-27791-2	6" x NH	240	175	6
051141-27792-9	6" x NH	320	175	6

3M™ Stikit™ Disc/
Disc Roll 735U

- 3M ceramic aluminum oxide blend abrasive grain on a C wt. paper
- Load-resistant coating
- Sharp-cutting and durable
- Ideal for wood, soft metals, fiberglass and solid surface



UPC	Diameter	Grade	Discs/Roll	Qty./Case
Disc Rolls				
051111-51229-6	5" x NH	P80	100	4
051111-51230-2	5" x NH	P100	100	4
051111-51231-9	5" x NH	P120	100	4
051111-51232-6	5" x NH	P150	100	4
051111-51233-3	5" x NH	P180	100	4
051111-51234-0	5" x NH	P220	100	4
Paper Backing with Tabbed Liner				
051141-20760-5	5" x NH	P80	50	5
051141-20762-9	5" x NH	P100	50	5
051141-20764-3	5" x NH	P120	50	5
051141-20766-7	5" x NH	P150	50	5
051141-20768-1	5" x NH	P180	50	5
051141-20770-4	5" x NH	P220	50	5
051141-24042-8	6" x NH	P80	50	5
051141-24043-5	6" x NH	P100	50	5
051141-24044-2	6" x NH	P120	50	5
051141-24045-9	6" x NH	P150	50	5
051141-24046-6	6" x NH	P180	50	5
051141-24047-3	6" x NH	P220	50	5

3M™ Stikit™
Disc Roll 763U

- 3M ceramic aluminum oxide blend abrasive grain on a heavy F wt. paper backing

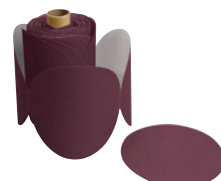

UPC	Diameter	Grade	Discs/Roll	Qty./Case
Paper Backing				
051144-80942-4	5" x NH	60	100	4
051144-80943-1	5" x NH	80	100	4
051144-80944-8	5" x NH	P100	100	4
051144-80945-5	5" x NH	P120	100	4
051144-80946-2	6" x NH	60	100	4
051144-80947-9	6" x NH	80	100	4

3M™ Stikit™ Disc 900DZ

- High performance 3M ceramic abrasive grain on a J wt. backing
- Open coat to reduce loading
- Individual discs with liner

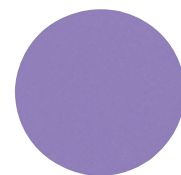

UPC	Diameter	Grade	Min./Case
Paper Backing			
051111-49639-8	5" x NH	80	50/250
051111-49640-4	5" x NH	P100	50/250
051111-49641-1	5" x NH	P120	50/250
051111-49643-5	5" x NH	P150	50/250
051111-49642-8	5" x NH	P180	50/250
051111-49644-2	5" x NH	P220	50/250

3M™ PSA Discs

3M™ PSA Cloth Disc 348D

- Aluminum oxide on an X wt. cloth backing
- Heavy-duty, cloth-backed discs for more aggressive applications
- Provides excellent adhesion while removing easily



UPC	Diameter	Grade	Min./Case
Cloth Backing			
051144-20913-2	2"	36	50/200
051144-20911-8	2"	50	50/200
051144-20910-1	2"	60	50/200
051144-20909-5	2"	80	50/200
051144-20908-8	2"	P100	50/200
051144-20907-1	2"	P120	50/200
051144-01335-7	3"	40	50/200
051144-01334-0	3"	50	50/200
051144-01333-3	3"	60	50/200
051144-01332-6	3"	80	50/200
051144-01331-9	3"	P100	50/200
051144-01330-2	3"	P120	50/200
051144-20891-3	5"	36	50/250
051144-20890-6	5"	40	50/250
051144-20889-0	5"	50	50/250
051144-20888-3	5"	60	50/250
051144-20887-6	5"	80	50/250
051144-20886-9	5"	P100	50/250
051144-20885-2	5"	P120	50/250
051144-20884-5	5"	P150	50/250
051144-20883-8	5"	P180	50/250
051144-20881-4	5"	P240	50/250
051144-21639-0	6"	36	50/250
051144-21731-1	6"	40	50/250
051144-20879-1	6"	50	50/250
051144-20878-4	6"	60	50/250
051144-20877-7	6"	80	50/250
051144-20876-0	6"	P100	50/250
051144-21497-6	6"	P120	50/250
051144-20874-6	8"	36	50/250
051144-20873-9	8"	40	50/250
051144-20871-5	8"	60	50/250
051144-20870-8	8"	80	50/250
051144-20868-5	8"	P120	50/250

3M™ PSA Cloth Disc 348D (cont.)

UPC	Diameter	Grade	Min./Case
051144-88906-8	12"	36	10
051144-88905-1	12"	40	10
051144-88904-4	12"	50	10
051144-88903-7	12"	60	10
051144-88902-0	12"	80	10
051144-88901-3	12"	P100	10
051144-88890-0	16"	36	10
051144-88889-4	16"	40	10
051144-88887-0	16"	60	10
051144-88886-3	16"	80	10
051144-88882-5	18"	36	10
051144-88880-1	18"	60	10
051144-88878-8	20"	36	10
051144-88877-1	20"	40	10
051144-88876-4	20"	50	10
051144-88875-7	20"	60	10
051144-88874-0	20"	80	10
051144-20802-9	24"	36	10
051144-20801-2	24"	40	10
051144-20798-5	24"	80	10

3M™ PSA Disc 777F

- 3M ceramic aluminum oxide blend abrasive grain on a polyester cloth backing
- Heavy-duty YF wt. backing provides great strength and flexibility
- Provides long life and fast cut on multiple surfaces
- Includes a grinding aid for cooler running

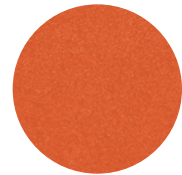

UPC	Diameter	Grade	Qty./Case
Cloth Backing			
051144-88869-6	12"	36	10
051144-88873-3	12"	40	10
051144-88872-6	12"	50	10
051144-88871-9	12"	60	10
051144-88870-2	12"	80	10

3M™ Random Orbital Series — Elite Series

Upgrades from Original Series — Improved durability, ergonomics and noise level

- 1 Aluminum housing for added durability and reduced vibration; Durable composite cover helps prevent cracked housings
- 2 **Recessed Lever** eliminates pinch points
- 3 Extended cover with **3M™ Gripping Material** allows better control with reduced effort, insulates from cold and reduces vibration
- 4 Safer **Thumb Wheel** mounted speed control reduces inadvertent speed changes
- 5 Wider port for **more efficient dust capture**
- 6 **Internal Muffler** results in less breakage, SGV 6 dB quieter
- 7 **Integrated Wrist Support** for comfort and leverage
- 8 Clearance for large inlet coupler
- 9 **Center Mount Exhaust** for more finger room, better dust collection airflow

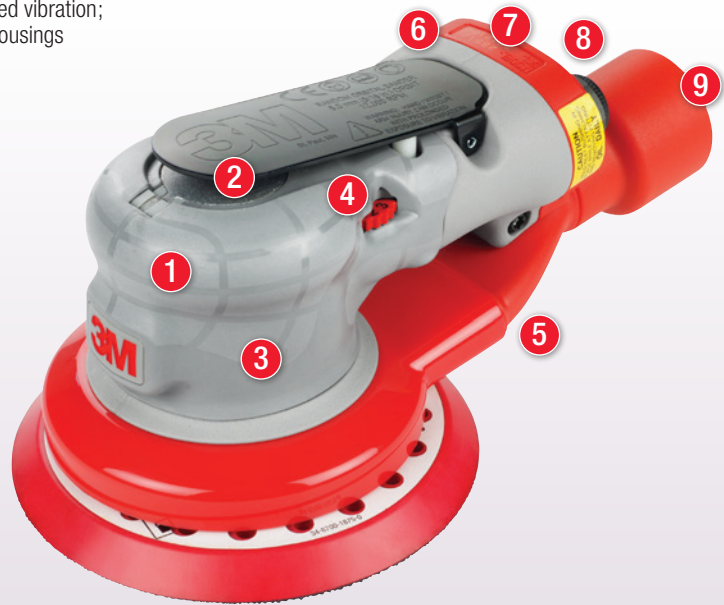

Red Text = Proprietary 3M design feature

3M™ Elite Non-Vacuum Random Orbital Sanders

• Powerful and popular non-vacuum tools meet or exceed highest performance standards



Model No.	Tool Dia. Inch (mm)	Orbit Dia. Inch (mm)	Motor HP (W)	Max RPM	Weight Pound (kg)	Length Inch (mm)	Height Inch (mm)	Airflow Rate SCFM (LPM)	Pad Included	UPC
28494	3 (77)	3/16 (5)	0.28 (209)	12,000	1.52 (.692)	5.78 (147)	3.64 (92.5)	17 (481)	Hookit™ 20350	051141-28494-1
28496	3 (77)	3/32 (2.5)	0.28 (209)	12,000	1.31 (.596)	5.78 (147)	3.38 (86)	17 (481)	Hookit™ 20350	051141-28496-5
28583	5 (127)	3/8 (9.5)	0.28 (209)	12,000	1.81 (.825)	6.77 (172)	3.58 (91)	17 (481)	Stikit™ 20351	051141-28583-2
28495	5 (127)	5/16 (8)	0.28 (209)	12,000	1.8 (.817)	6.77 (172)	3.58 (91)	17 (481)	Stikit™ 20351	051141-28495-8
28497	5 (127)	3/16 (5)	0.28 (209)	12,000	1.76 (.8)	6.77 (172)	3.58 (91)	17 (481)	Stikit™ 20351	051141-28497-2
NEW! 28708	5 (127)	3/16 (5)	0.28 (209)	12,000	1.76 (.8)	6.77 (172)	3.58 (91)	17 (481)	Hookit™ 20352	051141-28708-9
28498	5 (127)	3/32 (2.5)	0.28 (209)	12,000	1.72 (.781)	6.77 (172)	3.58 (91)	17 (481)	Stikit™ 20351	051141-28498-9
28582	6 (152)	3/8 (9.5)	0.28 (209)	12,000	1.94 (.881)	7.36 (187)	3.58 (91)	17 (481)	Stikit™ 20354	051141-28582-5
28499	6 (152)	5/16 (8)	0.28 (209)	12,000	1.91 (.869)	7.36 (187)	3.58 (91)	17 (481)	Stikit™ 20354	051141-28499-6
28500	6 (152)	3/16 (5)	0.28 (209)	12,000	1.86 (.844)	7.36 (187)	3.58 (91)	17 (481)	Stikit™ 20354	051141-28500-9
28501	6 (152)	3/32 (2.5)	0.28 (209)	12,000	2.1 (.957)	7.36 (187)	3.58 (91)	17 (481)	Stikit™ 20354	051141-28501-6

3M™ Power Tools for Random Orbital Systems

3M™ Elite Self-Generated Vacuum Random Orbital Sanders*

- Featuring 3M patented Clean Sanding system with improved filter bag



Model No.	Tool Dia. Inch (mm)	Orbit Dia. Inch (mm)	Motor HP (W)	Max RPM	Weight Pound (kg)	Length Inch (mm)	Height Inch (mm)	Airflow Rate SCFM (LPM)	Pad Included	UPC
28511	3 (77)	3/16 (5)	0.28 (209)	12,000	1.65 (.752)	8.22 (209)	3.64 (92.5)	17 (481)	Hookit™ 20350	051141-28511-5
28513	3 (77)	3/32 (2.5)	0.28 (209)	12,000	1.43 (.651)	8.14 (207)	3.44 (87.5)	17 (481)	Hookit™ 20350	051141-28513-9
28563	5 (127)	3/8 (9.5)	0.28 (209)	12,000	1.93 (.874)	9.21 (234)	3.64 (92.6)	17 (481)	Hookit™ 20353	051141-28563-4
28512	5 (127)	5/16 (8)	0.28 (209)	12,000	1.9 (.866)	9.21 (234)	3.64 (92.6)	17 (481)	Hookit™ 20353	051141-28512-2
28514	5 (127)	3/16 (5)	0.28 (209)	12,000	1.87 (.85)	9.21 (234)	3.64 (92.6)	17 (481)	Hookit™ 20353	051141-28514-6
28515	5 (127)	3/32 (2.5)	0.28 (209)	12,000	1.83 (.833)	9.21 (234)	3.64 (92.6)	17 (481)	Hookit™ 20353	051141-28515-3
28562	6 (152)	3/8 (9.5)	0.28 (209)	12,000	2.06 (.939)	9.64 (245)	3.64 (92.6)	17 (481)	Hookit™ 20356	051141-28562-7
28510	6 (152)	5/16 (8)	0.28 (209)	12,000	2.04 (.927)	9.64 (245)	3.64 (92.6)	17 (481)	Hookit™ 20356	051141-28510-8
28516	6 (152)	3/16 (5)	0.28 (209)	12,000	1.99 (.904)	9.64 (245)	3.64 (92.6)	17 (481)	Hookit™ 20356	051141-28516-0
28517	6 (152)	3/32 (2.5)	0.28 (209)	12,000	1.92 (.874)	9.64 (245)	3.64 (92.6)	17 (481)	Hookit™ 20356	051141-28517-7

*One (1) each of the following included: 3M™ Clean Sanding Filter Bag, Filter Bag Adapter, Hose Seal

3M™ Elite Central-Vacuum-Ready Random Orbital Sanders

- Easily attaches to your existing central vacuum system for efficient dust-evacuation



Model No.	Tool Dia. Inch (mm)	Orbit Dia. Inch (mm)	Motor HP (W)	Max RPM	Weight Pound (kg)	Length Inch (mm)	Height Inch (mm)	Airflow Rate SCFM (LPM)	Pad Included	UPC
28503	3 (77)	3/16 (5)	0.28 (209)	12,000	1.63 (.742)	7.99 (203)	3.64 (92.5)	17 (481)	Hookit™ 20350	051141-28503-0
28505	3 (77)	3/32 (2.5)	0.28 (209)	12,000	1.41 (.644)	7.91 (201)	3.44 (87.5)	17 (481)	Hookit™ 20350	051141-28505-4
28561	5 (127)	3/8 (9.5)	0.28 (209)	12,000	1.91 (.868)	8.93 (227)	3.64 (92.6)	17 (481)	Hookit™ 20353	051141-28561-0
28504	5 (127)	5/16 (8)	0.28 (209)	12,000	1.89 (.86)	8.93 (227)	3.64 (92.6)	17 (481)	Hookit™ 20353	051141-28504-7
28506	5 (127)	3/16 (5)	0.28 (209)	12,000	1.86 (.844)	8.93 (227)	3.64 (92.6)	17 (481)	Hookit™ 20353	051141-28506-1
28507	5 (127)	3/32 (2.5)	0.28 (209)	12,000	1.82 (.826)	8.93 (227)	3.64 (92.6)	17 (481)	Hookit™ 20353	051141-28507-8
28560	6 (152)	3/8 (9.5)	0.28 (209)	12,000	2.04 (.930)	9.37 (238)	3.64 (92.6)	17 (481)	Hookit™ 20356	051141-28560-3
28502	6 (152)	5/16 (8)	0.28 (209)	12,000	2.02 (.918)	9.37 (238)	3.64 (92.6)	17 (481)	Hookit™ 20356	051141-28502-3
28508	6 (152)	3/16 (5)	0.28 (209)	12,000	1.97 (.896)	9.37 (238)	3.64 (92.6)	17 (481)	Hookit™ 20356	051141-28508-5
28509	6 (152)	3/32 (2.5)	0.28 (209)	12,000	1.91 (.869)	9.37 (238)	3.64 (92.6)	17 (481)	Hookit™ 20356	051141-28509-2

3M™ Non-Vacuum Random Orbital Sanders



Model No.	Tool Dia. Inch (mm)	Orbit Dia. Inch (mm)	Motor HP (W)	Max RPM	Weight Pound (kg)	Length Inch (mm)	Height Inch (mm)	Airflow Rate SCFM (LPM)	Pad Included	UPC
20317	5 (127)	3/16 (5)	0.28 (209)	12,000	1.65 (.75)	5.89 (149.6)	3.26 (82.9)	17 (481)	Stikit™ 20351	051141-20317-1
20324	6 (152)	5/16 (8)	0.28 (209)	12,000	1.78 (.81)	6.39 (162.3)	3.26 (82.9)	17 (481)	Stikit™ 20354	051141-20324-9
20325	6 (152)	3/16 (5)	0.28 (209)	12,000	1.74 (.79)	6.39 (162.3)	3.26 (82.9)	17 (481)	Stikit™ 20354	051141-20325-6

3M™ Self-Generated Vacuum Random Orbital Sanders*



Model No.	Tool Dia. Inch (mm)	Orbit Dia. Inch (mm)	Motor HP (W)	Max RPM	Weight Pound (kg)	Length Inch (mm)	Height Inch (mm)	Airflow Rate SCFM (LPM)	Pad Included	UPC
20252 [†]	3 (77)	3/16 (5)	0.28 (209)	12,000	1.30 (.59)	5.01 (127.33)	3.10 (78.61)	17 (481)	Hookit™ 20350	051141-20252-5
20319	5 (127)	3/16 (5)	0.28 (209)	12,000	1.83 (.83)	6.12 (155.4)	3.33 (84.5)	17 (481)	Hookit™ 20353	051141-20319-5
20208	6 (150)	5/16 (8)	0.28 (209)	12,000	1.96 (.89)	6.47 (164.4)	3.33 (84.5)	17 (481)	Hookit™ 20356	051141-20208-2
20327	6 (150)	3/16 (5)	0.28 (209)	12,000	1.96 (.89)	6.47 (164.4)	3.33 (84.5)	17 (481)	Hookit™ 20356	051141-20327-0

*One (1) each of the following included: 3M™ Clean Sanding Filter Bag, Filter Bag Adapter, Hose Seal

[†]Product to be replaced by Elite Series model.



3M™ Random Orbital Sander, 2-Hand

Model No.	Vacuum	Tool Dia. Inch (mm)	Orbit Dia. Inch (mm)	Motor HP (W)	Max RPM	Weight Pound (kg)	Length Inch (mm)	Height Inch (mm)	Airflow Rate SCFM (LPM)	Clean Sanding Pad Included	UPC
28337	Central/Non-Vac	6 (150)	3/8 (9.5)	0.45 (336)	12,000	2.90 (1.32)	12.93 (328.3)	4.43 (112.6)	21 (594)	Hookit™ 20356*	051141-28337-1
NEW! 28335	Self-Gen Vac	6 (150)	3/8 (9.5)	0.45 (336)	12,000	2.90 (1.32)	12.93 (328.3)	4.43 (112.6)	21 (594)	Hookit™ 20356*	051141-28335-7

*For 5" sanding using the 2-Hand Sander, use the 5" 3M™ Hookit™ D/F Disc Pad 28411

3M™ Electric Random Orbital Sanders

Consistent performance when air supply is inadequate or mobility is needed.

- Provides significant energy cost savings vs. pneumatics
- Low-profile design enables increased operator control and less vibration
- Extended, curved wrist rest for more support
- Exclusive 3M™ Gripping Material for added comfort and reduced vibration
- Variable speed settings: 7,000, 9,000 and 10,000 RPM



3M™ Electric Random Orbital Sander Kits

Kits include 3M™ Electric Sander, 3M™ Power Supply w/AC Power Cord (PN28436), 3M™ Power Cord (PN 28434) and Disc Pad (Non-Vacuum: 3M™ Stikit™ Disc Pad; Central Vacuum: 3M™ Hookit™ Clean Sanding Disc Pad). Kit includes canvas bag.

Model No.	Vacuum	Tool Dia. Inch (mm)	Orbit Dia. Inch (mm)	Motor HP (W)	Max RPM	Weight Pound (kg)	Length Inch (mm)	Height Inch (mm)	Pad Included	UPC
28519	Central Vac Kit	5 (127)	3/32 (2.5)	.20-.24 (149-179)	10,000	2.08 (.945)	8.42 (214)	3.8 (96.6)	Hookit™ 20353	051141-28519-1
28520	Central Vac Kit	5 (127)	3/16 (5)	.20-.24 (149-179)	10,000	2.12 (.965)	8.42 (214)	3.8 (96.6)	Hookit™ 20353	051141-28520-7
28521	Central Vac Kit	6 (150)	3/32 (2.5)	.20-.24 (149-179)	10,000	2.19 (.995)	8.85 (225)	3.8 (96.6)	Hookit™ 20356	051141-28521-4
28522	Central Vac Kit	6 (150)	3/16 (5)	.20-.24 (149-179)	10,000	2.24 (1.02)	8.85 (225)	3.8 (96.6)	Hookit™ 20356	051141-28522-1
28523	Non-Vac Kit	5 (127)	3/32 (2.5)	.20-.24 (149-179)	10,000	1.92 (.875)	6.81 (173)	3.82 (97.2)	Stikit™ 20351	051141-28523-8
28524	Non-Vac Kit	5 (127)	3/16 (5)	.20-.24 (149-179)	10,000	1.98 (.9)	6.81 (173)	3.82 (97.2)	Stikit™ 20351	051141-28524-5
28525	Non-Vac Kit	6 (150)	3/32 (2.5)	.20-.24 (149-179)	10,000	1.99 (.905)	7.28 (185)	3.82 (97.2)	Stikit™ 20354	051141-28525-2
28526	Non-Vac Kit	6 (150)	3/16 (5)	.20-.24 (149-179)	10,000	2.04 (.93)	7.28 (185)	3.82 (97.2)	Stikit™ 20354	051141-28526-9

Power Supply Input: 100-240 VAC, 47-63 Hz; Power Supply Output: 30 VDC, 5 Amps





3M™ Electric Random Orbital Sanders* (Sander Only)

Model No.	Vacuum	Tool Dia. Inch (mm)	Orbit Dia. Inch (mm)	Motor HP (W)	Max RPM	Weight Pound (kg)	Length Inch (mm)	Height Inch (mm)	Pad Included	UPC
28430	Central Vacuum	5 (127)	3/32 (2.5)	.20-.24 (149-179)	10,000	2.08 (.945)	8.42 (214)	3.8 (96.6)	Hookit™ 20353	051141-28430-9
28431	Central Vacuum	5 (127)	3/16 (5)	.20-.24 (149-179)	10,000	2.12 (.965)	8.42 (214)	3.8 (96.6)	Hookit™ 20353	051141-28431-6
28432	Central Vacuum	6 (150)	3/32 (2.5)	.20-.24 (149-179)	10,000	2.19 (.995)	8.85 (225)	3.8 (96.6)	Hookit™ 20356	051141-28432-3
28433	Central Vacuum	6 (150)	3/16 (5)	.20-.24 (149-179)	10,000	2.24 (1.02)	8.85 (225)	3.8 (96.6)	Hookit™ 20356	051141-28433-0
28426	Non-Vacuum	5 (127)	3/32 (2.5)	.20-.24 (149-179)	10,000	1.92 (.875)	6.81 (173)	3.82 (97.2)	Stikit™ 20351	051141-28426-2
28427	Non-Vacuum	5 (127)	3/16 (5)	.20-.24 (149-179)	10,000	1.98 (.9)	6.81 (173)	3.82 (97.2)	Stikit™ 20351	051141-28427-9
28428	Non-Vacuum	6 (150)	3/32 (2.5)	.20-.24 (149-179)	10,000	1.99 (.905)	7.28 (185)	3.82 (97.2)	Stikit™ 20354	051141-28428-6
28429	Non-Vacuum	6 (150)	3/16 (5)	.20-.24 (149-179)	10,000	2.04 (.93)	7.28 (185)	3.82 (97.2)	Stikit™ 20354	051141-28429-3

*Sanders require use of Power Supply w/AC Power Cord (PN28436) and 3M™ Power Cord (PN 28434)

Accessories for Random Orbital Systems

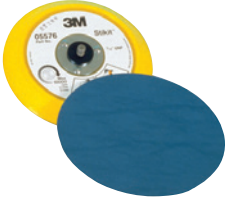
Product Name	UPC	Qty./Case	For Use With	Size/Description	Max RPM	Max OPM
3M™ Hook-and-Loop Disc Pad Holder No. 905 	048011-09448-9	1	Scotch-Brite™ Surface Conditioning Discs	5" x 5/16-24 EXT	10,000	N/A
3M™ Hookit™ Disc Pad 	051144-13625-4	10	3M™ Hookit™ Discs and Scotch-Brite™ Coating Removal Discs	5" x 3/4" x 5/16-24 EXT	10,000	12,000
	051141-28709-6	10	3M™ Hookit™ Discs and Scotch-Brite™ Coating Removal Discs	6" x 3/4" x 5/16-24 EXT	12,000	12,000
3M™ Hookit™ Low Profile Disc Pad 	051141-20352-2	10	3M™ Hookit™ Discs and Scotch-Brite™ RO Discs	5" x 3/8" x 5/16-24 EXT; Low Profile	12,000	12,000
	051131-05755-5	10	3M™ Hookit™ Discs and Scotch-Brite™ Coating Removal Discs	5" x 3/8" x 5/16-24 EXT; Low Profile	12,000	12,000
	051141-20355-3	10	3M™ Hookit™ Discs and Scotch-Brite™ RO Discs	6" x 3/8" x 5/16-24 EXT; Low Profile	12,000	12,000
3M™ Stikit™ Disc Pads 	051131-05545-2	10	3M™ Stikit™ Discs	5" x 11/16" 5/16-24 EXT; Low Profile Finishing	12,000	12,000
	051131-05546-9	10	3M™ Stikit™ Discs	6" x 11/16" 5/16-24 EXT; Low Profile Finishing	10,000	12,000
	051131-05555-1	10	3M™ Stikit™ Discs	5" x 3/8" 5/16-24 EXT; Low Profile	12,000	12,000
	051144-05575-3	1/10	3M™ Stikit™ Discs	5" x 3/4" x 5/16-24	10,000	12,000
	051141-28772-0	1/10	3M™ Stikit™ Discs	6" x 3/4" x 5/16-24	10,000	12,000
	051141-20351-5	10	3M™ Stikit™ Discs	5" x 3/8" x 5/16-24 EXT; Red Foam; Low Profile	12,000	12,000
	051141-20354-6	10	3M™ Stikit™ Discs	6" x 3/8" x 5/16-24 EXT; Red Foam; Low Profile	12,000	12,000
	051144-81821-1	10	3M™ Stikit™ Discs	5" x 3/4" 5/16-24 EXT	10,000	12,000
	051144-88736-1	10	3M™ Stikit™ Discs	5" x 3/8" 5/16-24 EXT; Tapered Edge; Low Profile	10,000	12,000

Abrasive Belt Systems



3M™ Belts

3M is the one-stop shop for all of your abrasive metalworking belt needs! We offer a product tailored to nearly every application and performance level. To select the best product for your application, check out our easy-to-use Belt Selection Guide. Each tier of product offers best-in-class performance at various price points. Once you have selected the product, use the Availability Guide to select your grade. The following section includes our most popular belt items, but remember, we can provide any size belt that you might need!

Abrasive Speed Recommendations for Off-Hand Applications

Alloy	Belt Speed (surface feet per minute)	Applicable Belt Grades
Cast Iron	7,000	24–120
Carbon Steel	6,500	24–120
Stainless Steel	6,500–7,000	36–120
Nickel Alloys	6,000	36–120
Titanium	2,500–3,000	36–180
Aluminum	7,500–8,500	24–120
Aluminum	6,500–7,000	Fine Grades
Brass	7,000–8,000	36–180
Rubber	4,500	36–180
Glass	2,500–5,000	80–400
Glass	6,000–8,000	80–400
Stone	7,000	36–180

3M™ Coated Abrasive Belt Availability Guide

Key • = Available grade **P** = FEPA (P-grade) **+** = 3M precision shaped grain

3M ID	Mineral	Backing	Grinding Aid	Use Dry/Wet	600	500	400	320	240	220	180	150	120	100	80	60	50	40	36	24
241E	Aluminum Oxide	XE		Dry				P		P	P	P	P	P	•					
302D		J		Dry	P	P	P	P	P	P	P	P	P	P	•	•				
332D		Flex X		Dry			P	P	P	P	P	P	P	P	•	•				
341D		X		Dry			P	P	P	P	P	P	P	P	•	•	•	•	•	•
361F		XF		Dry/Wet			P	P	P	P	P	P	P	P	•	•	•	•	•	•
461F	Silicon Carbide	XF		Dry/Wet	P		P	P	P	P	P	P	P	P	P	P		P	P	
577F	Alumina Zirconia	YF	Yes	Dry/Wet							•	•	•	•	•	•	•	•	•	•
747D	Ceramic A/O* Blend	X	Yes	Dry								P	P	P	•	•	•		•	
777F		YF	Yes	Dry/Wet							P	P	P	P	•	•	•	•	•	
947A	Precision Shaped Ceramic and A/O* Blend	X	Yes	Dry/Wet									+		+	+		+		
963G	Ceramic	YN		Dry/Wet									•	•	•	•	•	•	•	•
966F		YF		Dry/Wet											•	•	•	•	•	•
977F		YF	Yes	Dry/Wet									•	•	•	•	•	•	•	•
984F	Precision Shaped Ceramic	YF	Yes	Dry/Wet											+	+			+	
994F		ZF		Dry/Wet																+
997F		ZF	Yes	Dry/Wet																

*A/O – Aluminum Oxide

How to Use the Coated Abrasive Belt Selection Guide

1. Find the machine type that you will run this belt on.
2. Move down to the metal type that is being worked on.
3. Select the product from the list of **Good** — **Better** — **Best** and **Finishing** belts.
4. Check the Availability Guide for the grade.
5. Find the product on the following pages for available sizes.
6. If your size is not listed, contact your 3M distributor or 3M representative for ordering instructions.

3M™ Coated Abrasive Belt Selection Guide



Performance	Portable/ File Tool	Coarse Grade Power Grinding/ High Pressure	Slack of Belt Sander	Stroke Sander	Bench Top Belt Machine	Backstand/ Off Hand	Centerless & Roll Grinding		Flat Finishing	
							Dry	Wet	Dry	Wet
Carbon Steel										
Good	241E	577F	341D	—	341D	341D	—	—	341D	361F
Better	577F	963G	577F	—	577F	577F	577F	577F	577F	577F
Best	984F/947A	984F/994F/997F	947A	—	984F/947A	984F/947A	966F	966F	966F	966F
Finishing	—	—	341D/ Trizact*	—	341D/ Trizact*	3XXD**/ Trizact*	777F/ Trizact*	Trizact*	461F	461F
Stainless Steel										
Good	—	—	577F	341D	577F	577F	—	—	341D	361F
Better	577F	577F	777F	—	777F	777F	577F	577F	577F	577F
Best	984F/947A	984F/994F/997F	947A	747D/ 947A	984F/947A	984F/947A	977F	966F	984F	984F
Finishing	—	—	Trizact*	—	Trizact*	3XXD**/ Trizact*	777F/ Trizact*	Trizact*	461F/ Trizact*	461F/ Trizact*
Aluminum, Brass, Bronze										
Good	241E	577F	—	—	—	—	—	—	341D	361F
Better	577F	963G	577F	—	577F	577F	577F	577F	577F	577F
Best	984F/947A	984F/994F/997F	947A	—	984F/947A	984F/947A	—	—	—	—
Finishing	—	—	341D/ Trizact*	—	341D/ Trizact*	3XXD**/ Trizact*	341D/ Trizact*	461F	461F	461F
Cobalt and Nickel Alloys										
Good	—	—	577F	—	577F	577F	—	—	577F	577F
Better	577F	577F	777F	—	777F	777F	577F	577F	777F	777F
Best	984F/947A	984F/994F/997F	947A	—	984F/947A	984F/947A	977F	966F	984F	984F
Finishing	—	—	Trizact*	—	Trizact*	3XXD**/ Trizact*	777F/ Trizact*	Trizact*	461F	461F
Titanium										
Good	—	—	461F	—	461F	461F	—	—	—	461F
Better	577F	577F	577F	—	577F	577F	—	577F	—	577F
Best	984F	984F/994F/997F	—	—	984F	984F	—	966F	—	966F
Finishing	—	—	461F/Trizact*	—	461F/ Trizact*	3XXD**/ Trizact*	—	Trizact*	—	461F

*For specific Trizact product recommendations, see page 47.

**3XXD: Choose from 302D, 332D and 341D depending upon backing flexibility needed for application.

Note

For the ultimate in performance for coarse grade grinding in any application, be sure to try the latest innovation: 3M™ Cubitron™ II Metalworking Belts.

3M™ Trizact™ Belt Selection Guide

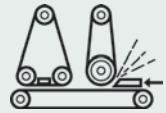
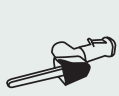

Portable Tools	Centerless/Roll Grinder/ Tool Post (Dry)		Stroke/ Platen Sander	Backstand, Robotic		Flat Finisher	
	Dry	Wet		Med. Pressure	Lt. Pressure	Dry	Wet
Mild Steel, Stainless, Nickel, Cobalt Alloys							
307EA	237AA	347FC	237AA	237AA	217EA	237AA	253FA
237AA	327DC	363FC/463FC	347FC	307EA	237AA	347FC	363FC
347FC	347FC	463FC/953FA	—	337DC	327DC	—	463FC
Aluminum, Brass, Copper							
217EA	237AA	347FC	—	237AA	217EA	237AA	253FA
237AA	327DC	363FC/463FC	237AA	307EA	237AA	347FC	363FC/463FC
347FC	347FC	—	347FC	337DC	327DC	—	—
Titanium							
237AA, 347FC, 407EA	407EA, 347FC	363FC/463FC	407EA	237AA, 337DC, 407EA	217EA, 327DC, 407EA	237AA	363FC/463FC
Chrome							
347FC	327DC	347FC	—	—	—	—	—
—	—	363FC/463FC	—	—	—	—	—
—	—	953FA	—	—	—	—	—

3M™ Trizact™ Belt Availability Guide

3M ID	Mineral	Backing	Description	Use Dry/Wet	A Grade																		
					300	160	110	100	90	80	65	60	45	35	30	20	16	10	6	5	3		
217EA	Aluminum Oxide	Flex. J wt.	Low Pressure	Dry				•	•	•	•	•	•	•	•	•	•	•					
237AA		Semi Flex. X wt.	Low-Med Pressure	Dry		•		•	•	•	•	•	•	•	•	•	•	•	•				
253FA		Stiff X wt.	Low-Med Pressure	Wet				•	•	•	•	•	•	•	•	•	•	•	•	•			
305EA		Flex. J wt.	Fine Finishing	Dry																	•	•	
307EA		Flex. J wt.	Low-Med Pressure	Dry				•	•	•	•	•	•	•	•	•	•	•	•	•	•		
327DC		Semi Flex. X wt.	Low Pressure	Dry	•	•		•		•	•	•	•	•	•	•	•	•	•	•	•		
337DC		Semi Flex. X wt.	Med Pressure	Dry	•	•		•		•	•	•	•	•	•	•	•	•	•	•	•		
347FC		Semi Flex. X wt.	High Pressure	Wet/Dry	•	•		•		•	•	•	•	•	•	•	•	•	•	•	•		
363FC		Stiff YF wt.	Med-High Pressure	Wet	•	•		•		•	•	•	•	•	•	•	•	•	•	•	•		
407EA		Silicon Carbide	Flex. J wt.	Low-Med Pressure	Dry			•		•		•					•						
463FC	Stiff YF wt.		Med-High Pressure	Wet											•		•	•	•	•	•		
953FA	Ceramic	Stiff YF wt.	Med-High Pressure	Wet	•	•		•		•	•	•	•	•	•	•	•	•	•	•	•		

3M™ Cubitron™ II Belts

3M™ Cubitron™ II Metalworking Belt 984F

- Made with revolutionary 3M precision shaped abrasive grain technology
- YF wt. backing
- Average up to 30% faster cutting on hard-to-grind metals than the next-best competitive belt
- Lasts up to 4 times as long as conventional ceramic aluminum oxide belts
- Cuts cooler — diverts heat from the work piece and belt to the swarf
- Helps eliminate burnishing and heat stress

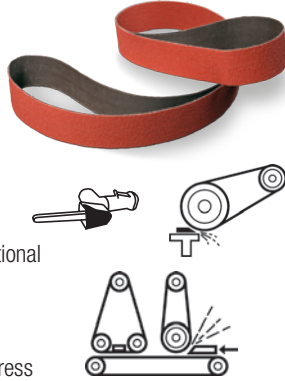

UPC	W x L	Grade	Min./Case
Portable, Backstand, Benchtop, Flat Finishing			
051141-55032-9	1/4" x 24"	60+	50/200
051141-27511-6	1/2" x 18"	36+	50/200
051141-55041-1	1/2" x 18"	60+	50/200
051141-55048-0	1/2" x 18"	80+	50/200
051141-27512-3	1/2" x 24"	36+	50/200
051141-55031-2	1/2" x 24"	60+	50/200
051141-55054-1	1/2" x 24"	80+	50/200
051141-55040-4†	1/2" x 42"	60+	200
051141-55064-0	3/4" x 18"	36+	50/200
051141-55030-5	3/4" x 18"	60+	50/200
051141-55047-3	3/4" x 18"	80+	50/200
051141-55065-7	3/4" x 20-1/2"	36+	50/200
051141-55055-8	3/4" x 20-1/2"	80+	50/200
051141-55046-6	1" x 11"	60+	50/500
051141-55050-3†	1" x 11"	80+	50/500
051141-55060-2†	1" x 42"	80+	25/200
051141-27514-7	1" x 132"	36+	100
051141-55039-8	1" x 132"	60+	25/200
051141-55052-7	1" x 132"	80+	25/200
051141-55066-4†	1-1/2" x 132"	36+	25/50

† Made-to-Order

3M™ Cubitron™ II Metalworking Belt 984F (cont.)

UPC	W x L	Grade	Qty./Case
051141-55068-8	2" x 60"	36+	10/50
051141-55036-7†	2" x 60"	60+	25/50
051141-27516-1	2" x 72"	36+	50
051141-55034-3	2" x 72"	60+	25/50
051141-55057-2	2" x 72"	80+	25/50
051141-55067-1	2" x 118"	36+	10/50
051141-27460-7	2" x 132"	36+	50
051141-55044-2	2" x 132"	60+	25/50
051141-55056-5	2" x 132"	80+	25/50
051141-55069-5	2-1/2" x 60"	36+	10/50
051141-27853-7†	2-1/2" x 60"	60+	25/50
051141-55058-9†	2-1/2" x 60"	80+	25/50
051141-27461-4	3" x 132"	36+	25
051141-55043-5	3" x 132"	60+	25
051141-55051-0	3" x 132"	80+	25
051141-55042-8	3-1/2" x 15-1/2"	60+	50
051141-55049-7	3-1/2" x 15-1/2"	80+	50
051141-27462-1	4" x 132"	36+	25
051141-55070-1	5" x 132"	36+	25
051141-55071-8	6" x 48"	36+	10/20
051141-55037-4	6" x 48"	60+	20
051141-55059-6†	6" x 48"	80+	20
051141-55035-0	6" x 60"	60+	20
051141-27515-4	6" x 132"	36+	10/20
051141-55072-5	8" x 107"	36+	5/10
051141-27513-0	8" x 132"	36+	10
051141-55063-3†	37" x 60"	80+	2
051141-55062-6†	37" x 75"	80+	2

† Made-to-Order

3M Precision Shaped Grain

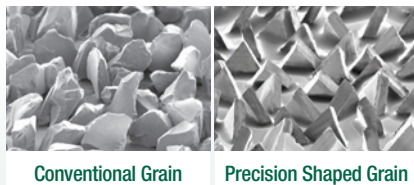

Conventional Grain

Precision Shaped Grain

Triangular-shaped grain (right) is electrostatically oriented to form sharp peaks, each acting like individual cutting tools that wear evenly for super long life and consistency.



Conventional Ceramic

3M™ Cubitron™ II

3M precision shaped grain sharpens as it wears. Compared to conventional ceramic abrasive grain, 3M™ Cubitron™ II abrasive grain belts **cut faster** and **last longer!**

Our new lineup of 3M™ Cubitron™ II Abrasive Belts

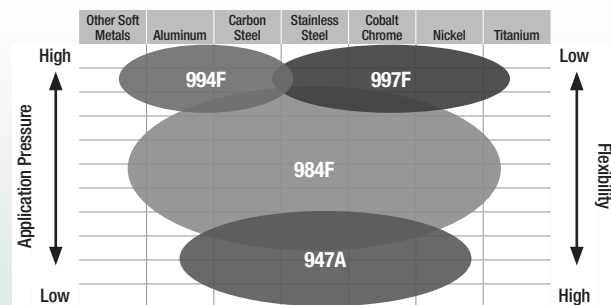

CUBITRON™ II

3M™ Cubitron™ II Belts

3M™ Cubitron™ II Abrasive Belt 947A



- Made with revolutionary 3M precision shaped abrasive grain technology
- Flexible X wt. poly-cotton backing
- Optimized for low-medium pressure applications on stainless, mild steel and aluminum

UPC	W x L	Grade	Min./Case
051125-94700-8	1/4" x 24"	60+	50/200
051125-94701-5	1/4" x 24"	80+	50/200
051125-94702-2	1/4" x 24"	120+	50/200
051125-94703-9	1/2" x 18"	60+	50/200
051125-94704-6	1/2" x 18"	80+	50/200
051125-94705-3	1/2" x 18"	120+	50/200
051125-94706-0	1/2" x 24"	60+	50/200
051125-94707-7	1/2" x 24"	80+	50/200
051125-94708-4	1/2" x 24"	120+	50/200
051125-94709-1	3/4" x 18"	60+	50/200
051125-94710-7	3/4" x 18"	80+	50/200
051125-94711-4	3/4" x 18"	120+	50/200
051125-94712-1	3/4" x 20-1/2"	60+	50/200
051125-94713-8	3/4" x 20-1/2"	80+	50/200
051125-94714-5	3/4" x 20-1/2"	120+	50/200
051125-94715-2	1" x 11"	80+	50/200
051125-94716-9	1" x 11"	120+	50/200
051125-94717-6	1" x 30"	80+	50/200
051125-94718-3	1" x 30"	120+	50/200
051125-94719-0	1" x 42"	80+	25/50
051125-94720-6	1" x 42"	120+	25/50
051125-94721-3	2" x 60"	60+	25/50
051125-94722-0	2" x 60"	80+	25/50
051125-94723-7	2" x 60"	120+	25/50
051125-94724-4	2" x 72"	60+	25/50
051125-94725-1	2" x 72"	80+	25/50
051125-94726-8	2" x 72"	120+	25/50
051125-94727-5	2" x 132"	60+	25/50
051125-94728-2	2" x 132"	80+	25/50
051125-94729-9	2" x 132"	120+	25/50
051125-94730-5	3" x 132"	60+	25
051125-94731-2	3" x 132"	80+	25
051125-94732-9	3" x 132"	120+	25
051125-94733-6	3-1/2" x 15-1/2"	60+	10/50
051125-94734-3	3-1/2" x 15-1/2"	80+	10/50
051125-94735-0	3-1/2" x 15-1/2"	120+	10/50
051125-94736-7	6" x 48"	60+	20
051125-94737-4	6" x 48"	80+	20
051125-94738-1	6" x 48"	120+	20

3M™ Cubitron™ II Abrasive Belt 994F



- Made with revolutionary 3M precision shaped abrasive grain technology
- Tough, durable ZF wt. cloth backing
- Optimal for high pressure carbon steel and aluminum applications

UPC	Grade	W x L	Min./Case
051141-54677-3	36+	Belt sizes made to order. Specify UPC, grade and belt size (W" x L"). Belts wider than 25" require multiple splices.	Determined by belt size.

3M™ Cubitron™ II Abrasive Belt 997F



- Made with revolutionary 3M precision shaped abrasive grain technology
- Tough, durable ZF wt. cloth backing
- Superb in high pressure stainless, cobalt chrome and nickel alloy applications

UPC	Grade	W x L	Min./Case
051141-54382-6	36+	Belt sizes made to order. Specify UPC, grade and belt size (W" x L"). Belts wider than 25" require multiple splices.	Determined by belt size.

3M™ Trizact™ Abrasive Belts

3M™ Trizact™ Abrasive Belts

The unique microreplicated construction used in 3M™ Trizact™ Abrasives can deliver consistent, predictable finishes, higher, more even rates of cut, cooler grinding and finishing temperatures, and reduced processing steps. 3M invented microreplication technology, which is the science of creating small, precisely shaped three-dimensional structures and then reproducing them on a variety of surfaces.

Trizact Abrasive Grading System

The unique construction of Trizact abrasives requires a different grading system. Grade is defined by the average particle size in microns and begins with an “A”.

Trizact Abrasive Grade	FEPA (P-Grade)
A5	P3000
A6	—
A10	P1500
A16	P1200
A20	P1000
A30	P600
A35	—
A45	P400
—	P320
A60	—
A65	—
A75	P240
A80	—
A90	P220
A100	P180
A110	P180
A130	P150
A160	P120

The Difference is in the Construction

Trizact abrasives allow you to say “goodbye” to erratic, inconsistent finishes generated by conventional coated abrasives. Here’s why:

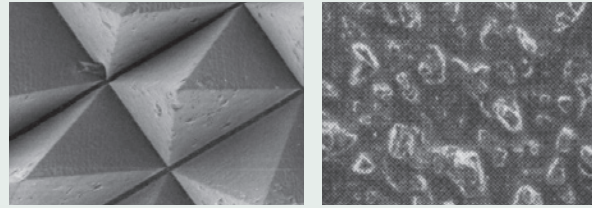

Three-dimensional structures uniformly distributed over the entire surface of 3M™ Trizact™ Abrasives (left) ensure consistent performance and eliminate belt-to-belt variation. Conventional abrasives (right), which feature randomly arranged minerals, wear and finish unevenly.



Conventional abrasives start out sharp, but they dull quickly.

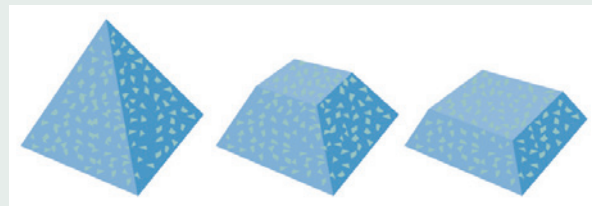

3M™ Trizact™ Abrasives have three-dimensional structures containing multiple layers of abrasive mineral. As these pyramid-like structures wear, fresh, sharp mineral is exposed.

3M™ Trizact™ Abrasive Belts

3M™ Trizact™ 217EA

- Ideal for aluminum, copper, brass and zinc alloys to final finishing
- Good for low pressure applications
- Flexible belt for intermediate finish and dimensioning



UPC	W x L	Grade	Min./Case
051125-23664-5†	4" x 84"	A45	50
051125-15686-8†	4" x 106"	A45	50
051125-20639-6†	4" x 118"	A6	50
051125-14350-9†	4" x 118"	A16	50
051111-66834-4†	4" x 118"	A30	50
051125-13733-1†	4" x 118"	A45	50
051125-16987-5†	4" x 120"	A16	50
051111-66830-6†	4" x 132"	A6	50
051111-69360-5†	4" x 132"	A16	50
051111-66835-1†	4" x 132"	A30	50
051111-66841-2†	4" x 132"	A45	50
051111-69669-9†	4" x 132"	A65	50
051119-05828-4†	4" x 132"	A80	50
051125-12699-1†	4" x 168"	A30	50
051125-12479-9†	4" x 168"	A80	50

† Made-to-Order

3M™ Trizact™ 237AA

- Semi-flexible abrasive
- Aluminum oxide mineral
- Great choice for stainless steel finishes

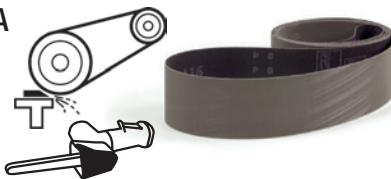

UPC	W x L	Grade	Qty./Case
051119-82624-1†	1" x 11"	A6	500
051125-32361-1†	1" x 11"	A16	500
051115-27208-0†	1" x 11"	A45	500
051111-66892-4†	1" x 11"	A65	500
051111-69366-7†	1" x 11"	A100	500
051125-22681-3†	1" x 12"	A100	200
051111-69377-3†	1" x 30"	A30	200
051125-15699-8†	1" x 42"	A16	200
051125-08603-5†	1" x 42"	A100	200
051111-69676-7†	1" x 42"	A160	20
051119-09095-6†	1" x 60"	A6	200
051119-09093-2†	1" x 60"	A16	200
051119-10286-4†	1" x 60"	A45	200
051115-27051-2†	1" x 60"	A65	200

† Made-to-Order

3M™ Trizact™ 237AA (cont.)

UPC	W x L	Grade	Min./Case
051119-10263-5†	1" x 64"	A6	200
051125-55143-4†	1" x 65"	A16	200
051111-66945-7†	1" x 130"	A100	20
051115-27112-0†	1" x 132"	A45	200
051115-27111-3†	1" x 132"	A100	200
051115-27804-4†	2" x 34"	A100	50
051111-69673-6†	2" x 48"	A16	25/50
051115-27731-3†	2" x 48"	A30	50
051119-09379-7†	2" x 48"	A45	50
051125-20671-6†	2" x 48"	A80	50
051111-69043-7†	2" x 48"	A100	50
051119-84184-8†	2" x 48"	A160	50
051115-27408-4†	2" x 60"	A65	50
051119-59769-1†	2" x 60"	A80	50
051125-54544-0†	2" x 60"	A100	50
051115-27487-9†	2" x 72"	A16	50
051115-27653-8†	2" x 72"	A30	50
051115-27787-0†	2" x 72"	A65	50
051115-27904-1†	2" x 72"	A80	50
051111-69671-2†	2" x 72"	A100	25/50
051115-27849-5†	2" x 72"	A160	50
051111-69369-8†	2" x 107"	A16	25/50
051111-69680-4†	2" x 107"	A45	25/50
051111-66938-9†	2" x 107"	A80	50
051111-69383-4†	2" x 118"	A6	25/50
051111-66860-3†	2" x 118"	A16	50
051125-22263-1†	2" x 118"	A30	50
051111-66856-6†	2" x 132"	A6	50
051111-69370-4†	2" x 132"	A16	25/50
051115-27658-3†	2" x 132"	A30	50
051111-69028-4	2" x 132"	A45	50
051111-69036-9†	2" x 132"	A65	50
051111-69044-4	2" x 132"	A100	50
051119-77007-0†	2" x 148"	A16	50
051125-20169-8†	2" x 148"	A100	50
051125-22175-7†	2" x 157"	A65	50
051111-69294-3†	3" x 24"	A6	50
051111-69290-5†	3" x 24"	A16	50
051111-69291-2†	3" x 24"	A30	50
051125-14935-8†	3" x 24"	A80	50
051119-83067-5†	3" x 60"	A16	50
051111-69045-1†	3" x 60"	A100	50
051119-82467-4†	3" x 72"	A80	50
051111-69295-0†	3" x 72"	A160	25/50

† Made-to-Order

3M™ Trizact™ Abrasive Belts

3M™ Trizact™ 237AA (cont.)

UPC	W x L	Grade	Min./Case
051111-69015-4†	3" x 90"	A16	50
051111-69021-5†	3" x 90"	A30	50
051111-69029-1†	3" x 90"	A45	50
051111-69047-5†	3" x 90"	A100	50
051111-66863-4†	3" x 118"	A16	50
051111-69022-2†	3" x 118"	A30	50
051125-19954-4†	3" x 132"	A6	50
051111-51199-2	3" x 132"	A16	50
051111-51207-4	3" x 132"	A30	50
051111-51209-8	3" x 132"	A45	50
051111-69037-6†	3" x 132"	A65	50
051111-69051-2†	3" x 132"	A160	50
051111-66864-1†	3" x 148"	A16	50
051111-69292-9†	3" x 148"	A30	50
051111-69293-6†	3" x 148"	A45	50
051115-26995-0†	3" x 157"	A45	50
051115-27921-8†	3" x 157"	A65	50
051125-19529-4†	3" x 157"	A80	50
051115-27798-6†	3" x 168"	A16	25
051111-66876-4†	3" x 168"	A30	50
051115-28033-7†	3" x 168"	A45	50
051111-69371-1†	3" x 300"	A16	50
051111-69381-0†	3" x 300"	A45	50
051111-69385-8†	3" x 300"	A65	50
051115-27777-1†	3" x 346"	A80	25
051115-27145-8†	4" x 36"	A65	50
051111-66949-5†	4" x 36"	A100	50
051125-11794-4†	4" x 40"	A100	50
051119-68279-3†	4" x 48"	A100	50
051115-27859-4†	4" x 72"	A16	50
051125-10967-3†	4" x 84"	A65	50
051119-67382-1†	4" x 84"	A100	50
051115-27749-8†	4" x 90"	A6	50
051111-69016-1†	4" x 90"	A16	50
051111-51204-3	4" x 90"	A30	50
051111-69030-7†	4" x 90"	A45	50
051119-73517-8†	4" x 90"	A65	50
051115-27592-0†	4" x 90"	A80	50
051111-69672-9†	4" x 90"	A100	25/50
051115-27593-7†	4" x 90"	A160	50

† Made-to-Order

3M™ Trizact™ 237AA (cont.)

UPC	W x L	Grade	Min./Case
051115-27153-3†	4" x 106"	A30	50
051115-26818-2†	4" x 106"	A100	50
051111-66867-2†	4" x 118"	A16	50
051111-66878-8†	4" x 118"	A30	50
051111-66888-7†	4" x 118"	A45	50
051111-66897-9†	4" x 118"	A65	50
051125-17651-4†	4" x 118"	A100	50
051115-26883-0†	4" x 124"	A30	50
051111-69251-6†	4" x 132"	A6	25/50
051111-69017-8	4" x 132"	A16	50
051111-51214-2	4" x 132"	A30	50
051111-69031-4†	4" x 132"	A45	50
051111-69387-2†	4" x 132"	A65	25/50
051111-66941-9†	4" x 132"	A80	25/50
051111-69048-2†	4" x 132"	A100	50
051111-69375-9†	4" x 132"	A160	25/50
051111-66950-1†	4" x 146"	A100	50
051125-11757-9†	4" x 158"	A45	50
051115-27521-0†	4" x 168"	A16	50
051119-10264-2†	4" x 168"	A30	50
051119-08908-0†	4" x 168"	A65	50
051111-69681-1†	4" x 274"	A45	50
051115-27303-2†	4" x 352"	A160	50
051115-27467-1†	4" x 354"	A65	50
051111-68739-0†	4" x 354"	A100	25
051111-68738-3†	4" x 354"	A160	50

† Made-to-Order

3M™ Trizact™ 253FA

- Ideal for wet flat-finishing and wet intermediate finishing of centerless applications
- Great on stainless steel, carbon steel and carbon fibre composites

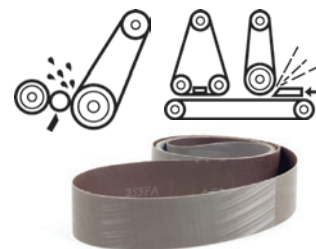

UPC	Grade	W x L	Min./Case
051135-13635-5	A6		
051135-13636-2	A16		
051135-13637-9	A30		
051135-13638-6	A45		
051135-13639-3	A65		
051135-13640-9	A80		
051135-13641-6	A100		

Belt sizes made to order. Specify UPC, grade and belt size (W" x L"). Belts wider than 25" require multiple splices.

Determined by belt size.

3M™ Trizact™ 307EA

- Flexible cloth backing
- Aluminum oxide mineral
- Perfect choice for preplate surface finishes



UPC	W x L	Grade	Min./Case
051111-67100-9†	1" x 42"	A80	200
051111-69408-4†	1" x 42"	A100	50/200
051111-67101-6†	1" x 60"	A80	200
051115-27801-3†	1" x 72"	A16	200
051115-27448-0†	1" x 72"	A45	200
051125-14659-3†	1" x 72"	A65	200
051119-63318-4†	1" x 76"	A6	200
051125-50495-9†	1" x 76"	A30	200
051111-67055-2†	1" x 77"	A6	200
051111-67068-2†	1" x 77"	A30	200
051115-19520-4†	1" x 77"	A45	25/200
051115-26828-1†	1" x 132"	A6	200
051115-27410-7†	1" x 132"	A16	200
051115-27346-9†	1" x 132"	A45	200
051115-27491-6†	1" x 132"	A80	200
051115-27830-3†	2" x 36"	A16	50
051125-40962-9†	2" x 48"	A65	50
051119-58606-0†	2" x 60"	A30	50
051119-75663-0†	2" x 60"	A45	50
051125-46217-4†	2" x 60"	A65	50
051125-11024-2	2" x 72"	A6	50
051111-69061-1	2" x 72"	A16	50
051111-69067-3	2" x 72"	A30	50
051111-69072-7†	2" x 72"	A45	50
051111-69074-1†	2" x 72"	A65	50
051111-69079-6	2" x 72"	A100	50
051125-34816-4	2" x 76"	A30	50
051111-61067-1†	2" x 83"	A6	200
051111-61066-4	2" x 83"	A16	200
051115-27125-0†	2" x 90"	A16	50
051125-47160-2†	2" x 96"	A65	50
051111-68818-2†	2" x 118"	A6	50
051119-09343-8†	2" x 118"	A16	50
051125-20950-2†	2" x 118"	A30	50
051125-20345-6†	2" x 118"	A45	50
051111-51206-7	2" x 132"	A6	25/50
051111-51202-9	2" x 132"	A16	25/50
051111-69068-0	2" x 132"	A30	50
051111-51210-4	2" x 132"	A45	50
051111-69075-8	2" x 132"	A65	50
051111-69077-2	2" x 132"	A80	50
051111-69080-2	2" x 132"	A100	50
051111-69409-1†	2" x 138"	A16	50
051111-67059-0†	2" x 148"	A6	50
051115-19517-4†	2" x 148"	A16	25/50
051111-69069-7†	2" x 148"	A30	50

† Made-to-Order

3M™ Trizact™ 307EA (cont.)

UPC	W x L	Grade	Min./Case
051125-20168-1†	2" x 148"	A45	50
051111-67091-0†	2" x 148"	A65	50
051111-67064-4†	3" x 60"	A16	50
051115-27893-8†	3" x 72"	A16	50
051125-38992-1†	3" x 72"	A30	50
051125-30837-3†	3" x 72"	A100	50
051111-69410-7†	3" x 90"	A16	25/50
051125-49713-8†	3" x 90"	A65	50
051111-67077-4†	3" x 96"	A30	50
051111-69256-1†	3" x 96"	A65	50
051111-68819-9†	3" x 118"	A6	50
051111-69063-5†	3" x 118"	A16	50
051111-51203-6	3" x 118"	A30	50
051111-67084-2†	3" x 118"	A45	50
051111-67106-1†	3" x 118"	A80	50
051111-67111-5†	3" x 118"	A100	50
051115-27418-3†	3" x 120"	A16	50
051125-20567-2†	3" x 120"	A30	50
051125-30879-3†	3" x 120"	A45	50
051111-69059-8†	3" x 132"	A6	50
051125-13220-6†	3" x 132"	A16 full flex	50
051111-51200-5	3" x 132"	A16	25/50
051111-51201-2	3" x 132"	A30	25/50
051125-16874-8†	3" x 132"	A30 full flex	50
051111-69073-4	3" x 132"	A45	50
051111-69076-5†	3" x 132"	A65	50
051111-69078-9	3" x 132"	A80	50
051111-69082-6†	3" x 132"	A100	50
051111-67065-1†	3" x 148"	A16	50
051115-27594-4†	3" x 168"	A6	50
051115-19518-1†	3" x 168"	A16	25/50
051111-67087-3†	3" x 168"	A45	50
051115-27604-0†	4" x 36"	A30	50
051111-69060-4†	4" x 90"	A6	50
051111-69064-2†	4" x 90"	A16	50
051115-19522-8†	4" x 90"	A65	25/50
051125-22401-7†	4" x 118"	A6	50
051111-69065-9	4" x 118"	A16	50
051111-69070-3†	4" x 118"	A30	50
051111-67107-8†	4" x 118"	A80	50
051111-67112-2†	4" x 118"	A100	50
051115-27766-5†	4" x 132"	A6	50
051111-69066-6†	4" x 132"	A16	50
051111-69071-0	4" x 132"	A30	50
051111-51212-8	4" x 132"	A45	50
051115-26922-6†	4" x 132"	A80	50
051119-73781-3†	4" x 132"	A100	50
051111-68821-2†	4" x 168"	A30	50
051115-26997-4†	4" x 240"	A16	25
051111-67113-9†	4" x 240"	A100	50

† Made-to-Order

3M™ Trizact™ Abrasive Belts

3M™ Trizact™ 327DC

- Use for mill line removal, intermediate scratch refinement, consistent dimensioning and consistent finishing applications
- Macroreplicated aluminum oxide on a flexible backing
- Grinding aid
- For dry use only



UPC	Grade	W x L	Min./Case
051135-94693-0	A30	Belt sizes made to order.	Determined by belt size.
051135-94692-3	A45	Specify UPC, grade and belt size (W" x L").	
051135-94691-6	A65		
051135-94690-9	A100		
051135-29683-7	A160	Belts wider than 25" require multiple splices.	
051135-94689-3	A300		

3M™ Trizact™ CF 337DC

- Macroreplicated structure provides long product life and consistent cut and finish
- For use on backstand grinders

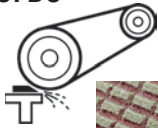

UPC	W x L	Grade	Qty./Case
051141-20646-2†	1" x 132"	A300	100
048011-33156-0	2" x 60"	A45	5
048011-33155-3	2" x 60"	A65	5
048011-33154-6†	2" x 60"	A100	5
048011-33153-9†	2" x 60"	A160	5
048011-33152-2†	2" x 60"	A300	5
048011-33161-4†	2" x 72"	A45	5
048011-33160-7†	2" x 72"	A65	5
048011-33159-1†	2" x 72"	A100	5
048011-33158-4†	2" x 72"	A160	5
048011-33157-7†	2" x 72"	A300	5
048011-33166-9†	2" x 132"	A45	5
048011-33165-2†	2" x 132"	A65	5
048011-33164-5†	2" x 132"	A100	5
048011-33163-8†	2" x 132"	A160	5
048011-33162-1†	2" x 132"	A300	5
048011-33171-3†	3" x 132"	A45	5
048011-33170-6†	3" x 132"	A65	5
048011-33169-0†	3" x 132"	A100	5
048011-33168-3†	3" x 132"	A160	5
048011-33167-6†	3" x 132"	A300	5

† Made-to-Order

3M™ Trizact™ 347FC

- 3M ceramic abrasive grain on a macroreplicated, flexible X wt. backing
- For high-pressure applications on hard metals, nickel alloys, titanium and stainless steel



UPC	Grade	W x L	Min./Case
051125-64275-0	A30	Belt sizes made to order. Specify UPC, grade and belt size (W" x L"). Belts wider than 25" require multiple splices.	Determined by belt size.
051125-64274-3	A45		
051125-64273-6	A65		
051125-64272-9	A100		
051125-64271-2	A160		
051125-64270-5	A300		

3M™ Trizact™ Cloth Belts 363FC

- Centerless/cylindrical/flat part grinding and finishing
- Macroreplicated aluminum oxide on a durable YF wt. cloth backing
- Use wet on zirconium, titanium, carbon steel, stainless steel and other alloys
- Long belt life improves productivity
- Reduce or eliminate belt break-in
- Consistent cut rate and finish from heavy deburring and defect removal to intermediate finishing

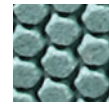

UPC	Grade	W x L	Min./Case
051135-98214-3	A30	Belt sizes made to order. Specify UPC, grade and belt size (W" x L"). Belts wider than 25" require multiple splices.	Determined by belt size.
051135-98213-6	A45		
051135-98212-9	A65		
051135-98211-2	A100		
051135-98210-5	A160		
051135-98209-9	A300		

3M™ Trizact™ Abrasive Belts

3M™ Trizact™ 407EA

- Use for mill line removal, intermediate scratch refinement, consistent dimensioning and consistent finishing applications
- Silicon carbide constructed on a flexible rayon cloth backing
- Grinding aid for cooler grinding
- Resin bonded for heat resistance



UPC	Grade	W x L	Min./Case
051135-91841-8	A20	Belt sizes made to order. Specify UPC, grade and belt size (W" x L"). Belts wider than 25" require multiple splices.	Determined by belt size.
051144-99004-7	A60		
051144-99005-4	A90		
051135-90527-2	A110		

3M™ Trizact™ Cloth Belts 463FC

- Wet centerless/flat part/finishing/polishing
- Macroreplicated silicon carbide on a durable YF wt. cloth backing
- Use wet on zirconium, titanium, carbon steel, stainless steel and other alloys
- Long belt life improves productivity
- Reduce or eliminate belt break-in
- Consistent finer grade ranges for fine finishes on all metals

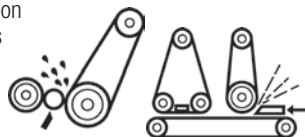
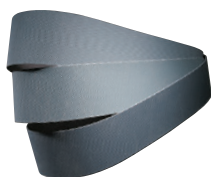

UPC	Grade	W x L	Min./Case
051135-98191-7	A6	Belt sizes made to order. Specify UPC, grade and belt size (W" x L"). Belts wider than 25" require multiple splices.	Determined by belt size.
051135-97955-6	A10		
051135-97954-9	A20		
051135-97953-2	A45		

3M™ Trizact™ Belts 953FA

- Use in wet centerless or flat grinding and finishing operations
- Process flexible belt that delivers consistent, predictable results
- Macroreplicated ceramic abrasive grain coated on waterproof cloth backing

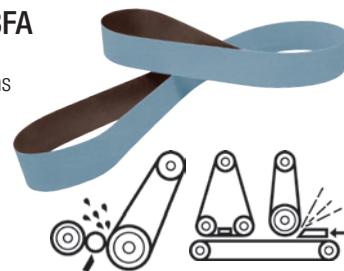

UPC	Grade	W x L	Min./Case
051135-29383-6	A6	Belt sizes made to order. Specify UPC, grade and belt size (W" x L"). Belts wider than 25" require multiple splices.	Determined by belt size.
051135-29507-6	A10		
051135-29382-9	A16		
051135-29381-2	A30		
051135-29380-5	A45		
051135-29379-9	A65		
051135-29378-2	A80		
051135-29377-5	A100		
051135-29375-1	A160		
051135-29373-7	A300		

3M™ Belts

241E

- Aluminum oxide on an XE wt. cloth backing
- High strength backing for tougher applications
- Use with 3M™ File Belt Sander



UPC	W x L	Grade	Min./Case
051144-26733-0	1/4" x 24"	60	50/200
051144-26732-3	1/4" x 24"	80	50/200
051144-26731-6	1/4" x 24"	120	50/200
051144-31170-5	1/2" x 12"	60	50/200
051144-26894-8†	1/2" x 12"	80	50/200
051144-26892-4†	1/2" x 12"	120	50/200
051144-72227-3†	1/2" x 18"	60	50/200
051144-72228-0	1/2" x 18"	80	50/200
051144-72229-7†	1/2" x 18"	120	50/200
051144-26725-5†	1/2" x 24"	50	50/200
051144-26723-1	1/2" x 24"	60	50/200
051144-26720-0	1/2" x 24"	80	50/200
051144-26719-4	1/2" x 24"	100	50/200
051144-26717-0†	1/2" x 24"	120	50/200
051144-26715-6	1/2" x 24"	180	50/200
051144-26714-9	1/2" x 24"	220	50/200
051144-14756-4	3/4" x 18"	60	50/200
051144-14519-5	3/4" x 18"	80	50/200
051144-14667-3	3/4" x 18"	120	50/200

† Made-to-Order

302D

- Aluminum oxide mineral
- Flexible belt for blending and finishing contoured and complex parts
- Works great on most metals
- For use on backstand grinders
- Grades 60, 80, P100–P600



UPC	W x L	Grade	Min./Case
051141-30867-8	2" x 118"	P120	25/50
051141-30870-8	2" x 118"	P150	25/50
051141-30873-9	2" x 118"	P180	25/50
051141-30876-0	2" x 118"	P220	25/50
051141-30885-2	2" x 118"	P320	25/50
051141-30888-3	2" x 118"	P400	25/50
051141-30710-7	2" x 132"	80	25/50
051141-30713-8	2" x 132"	P100	25/50
051141-30716-9	2" x 132"	P120	25/50
051141-30719-0	2" x 132"	P150	25/50
051141-30722-0	2" x 132"	P180	25/50
051141-30725-1	2" x 132"	P220	25/50
051141-30728-2	2" x 132"	P240	25/50
051141-30734-3	2" x 132"	P320	25/50
051141-30737-4	2" x 132"	P400	25/50
051141-30743-5	2" x 132"	P600	25/50
051141-30862-3	3" x 118"	80	25/50
051141-30865-4	3" x 118"	P100	25/50
051141-30874-6	3" x 118"	P180	25/50
051141-30877-7	3" x 118"	P220	25/50
051141-30886-9	3" x 118"	P320	25/50
051141-30780-0	3" x 132"	60	25/50
051141-30711-4	3" x 132"	80	25/50
051141-30714-5	3" x 132"	P100	25/50
051141-30717-6	3" x 132"	P120	25/50
051141-30720-6	3" x 132"	P150	25/50
051141-30723-7	3" x 132"	P180	25/50
051141-30726-8	3" x 132"	P220	25/50
051141-30729-9	3" x 132"	P240	25/50
051141-30732-9	3" x 132"	P280	25/50
051141-30735-0	3" x 132"	P320	25/50
051141-30738-1	3" x 132"	P400	25/50
051141-30741-1	3" x 132"	P500	25/50

Tech Tip

Select the Right Belt for Your Job

Choose from 302D, 332D and 341D depending upon backing flexibility needed for application as illustrated below:

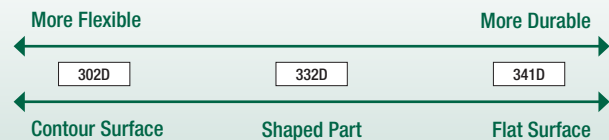

332D

- Aluminum oxide mineral
- Semi-flexible X wt. backing provides good durability when working on contoured parts
- For use on backstand grinders
- Works great on most metals
- Grades 60, 80, P100–P400



UPC	W x L"	Grade	Min./Case
051141-30776-3	2" x 132"	60	25/50
051141-30746-6	2" x 132"	80	25/50
051141-30749-7	2" x 132"	P100	25/50
051141-30752-7	2" x 132"	P120	25/50
051141-30758-9	2" x 132"	P180	25/50
051141-30761-9	2" x 132"	P220	25/50
051141-30764-0	2" x 132"	P240	25/50
051141-30770-1	2" x 132"	P320	25/50
051141-30750-3	3" x 132"	P100	25/50
051141-30753-4	3" x 132"	P120	25/50
051141-30756-5	3" x 132"	P150	25/50
051141-30759-6	3" x 132"	P180	25/50
051141-30762-6	3" x 132"	P220	25/50
051141-30765-7	3" x 132"	P240	25/50
051141-30768-8	3" x 132"	P280	25/50

341D (cont.)

UPC	W x L	Grade	Min./Case
051144-26571-8	2" x 48"	36	10/50
051144-26568-8	2" x 48"	50	10/50
051144-26564-0	2" x 48"	60	25/50
051144-26562-6	2" x 48"	80	25/50
051144-26561-9	2" x 48"	P100	25/50
051144-26560-2	2" x 48"	P120	25/50
051144-26424-7	2" x 60"	50	10/50
051144-33640-1	2" x 60"	60	25/50
051144-33639-5	2" x 60"	80	25/50
051144-33667-8	2" x 60"	P120	25/50
051144-26320-2	2" x 72"	36	10/50
051144-26316-5	2" x 72"	60	25/50
051144-33067-6	2" x 72"	80	25/50
051144-26312-7	2" x 72"	P120	25/50
051144-26309-7	2" x 72"	P180	25/50
051144-81752-8	2" x 72"	P240	25/50
051144-26408-7	2-1/2" x 60"	36	10/50
051144-26400-1	2-1/2" x 60"	60	25/50
051144-26396-7	2-1/2" x 60"	80	25/50
051144-26388-2	2-1/2" x 60"	P120	25/50
051144-26857-3	3-1/2" x 15-1/2"	60	10/50
051144-26856-6	3-1/2" x 15-1/2"	80	10/50
891040-02663-0	3-1/2" x 15-1/2"	P120	10/50
891040-01436-1	4" x 24"	36	25
891040-01439-2	4" x 24"	60	50
891040-01440-8	4" x 24"	80	50
051144-33647-0	4" x 132"	60	25
891040-01454-5	6" x 48"	36	10/20
891040-01455-2	6" x 48"	40	10/20
891040-01456-9	6" x 48"	50	10/20
891040-01457-6	6" x 48"	60	10/20
891040-10454-3	6" x 48"	80	20
891040-10455-0	6" x 48"	P100	20
891040-10456-7	6" x 48"	P120	20
051144-26517-6	6" x 48"	P150	20
051144-26515-2	6" x 48"	P180	20
051144-26513-8	6" x 48"	P240	20
051144-74271-4	37" x 60"	P120	5
051144-14420-4	37" x 75"	80	3
051144-33061-4	37" x 75"	P120	5
051144-14508-9	37" x 75"	P180	5

341D

- Aluminum oxide on an X wt. cloth backing
- Excellent all-around abrasive belt for blending and finishing
- For use on backstand, benchtop, stroke sanding, slack of belt and dry flat finishing equipment

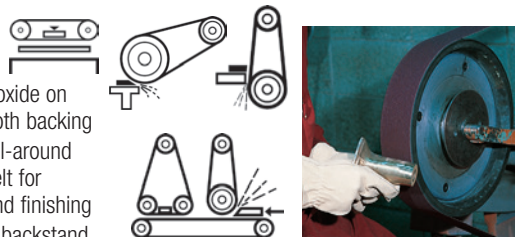

UPC	W x L	Grade	Min./Case
051144-26614-2	1" x 42"	36	50/200
051144-31823-0	1" x 42"	50	50/200
891040-01450-7	1" x 42"	60	25/100
891040-01451-4	1" x 42"	80	25/100
891040-01452-1	1" x 42"	P100	25/100
891040-01453-8	1" x 42"	P120	25/100
051144-26602-9	1" x 42"	P150	50/200
051144-26601-2	1" x 42"	P180	50/200
051144-26599-2	1" x 42"	P240	50/200
051144-26597-8	1" x 42"	P320	50/200
051144-26443-8	1-1/2" x 60"	36	10/50
051144-26441-4	1-1/2" x 60"	40	10/50
051144-26438-4	1-1/2" x 60"	60	25/50
051144-26436-0	1-1/2" x 60"	80	25/50

3M™ Belts

361F

- Aluminum oxide on an XF wt. backing
- Durable belt with a tough polyester backing that can be used wet or dry
- Ideal use in the grinding of sheets and coils, centerless, flat finishing and hand tool applications



UPC	W x L	Grade	Min./Case
051111-67159-7†	4" x 90"	P180	50
051111-67179-5†	4" x 90"	P320	50
051111-68840-3†	8" x 135"	P150	20
051111-68841-0†	8" x 135"	P180	20
051119-84596-9†	6" x 90"	60	20
051115-27707-8†	6" x 90"	P220	20
051125-09948-6†	8" x 135"	P320	20
051144-14773-1	37" x 60"	80	2
051144-14905-6	37" x 60"	P100	5
051144-11519-8	37" x 60"	P120	5
051144-76939-1	37" x 60"	P150	5
051144-11515-0	37" x 60"	P180	5
051144-76923-0	37" x 60"	P220	5
051144-81215-8	37" x 75"	P100	5
051144-76942-1†	37" x 75"	P120	5
051144-80037-7	37" x 75"	P150	5
051111-51215-9	37" x 75"	P180	5

† Made-to-Order

461F

- Silicon carbide mineral
- Durable cloth-backed belts
- For heavy duty grinding to fine finishing
- Resistant to tearing and will not easily nick
- For use on backstand, benchtop, slack of belt, flat finishing, centerless and wet roll grinding equipment



UPC	W x L	Grade	Min./Case
051111-67404-8†	4" x 118"	P220	50
051111-67405-5†	4" x 132"	P220	50
051111-67408-6†	4" x 132"	P320	50
051125-23665-2†	4" x 64"	P400	50
051125-67387-4	4" x 106"	P100	5/5
051144-04337-8	4" x 106"	P80	5/5
051144-04335-4†	4" x 106"	P120	50

† Made-to-Order

577F

- Alumina zirconia on a YF wt. cloth backing
- Resin bonded for heat resistance
- Features a grinding aid for cooler grinding
- For use on backstand, benchtop, slack of belt, portable, flat finishing, centerless and roll grinding equipment
- Can be run wet or dry

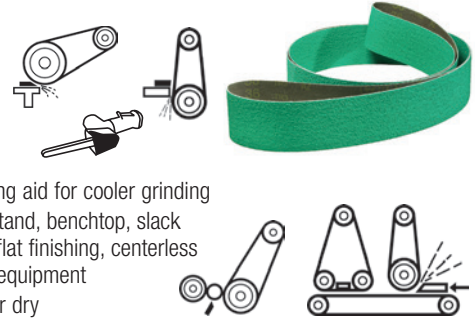

UPC	W x L	Grade	Min./Case
051141-30690-2	1/4" x 18"	60	50/200
051141-30691-9	1/4" x 18"	80	50/200
051141-30708-4	1/4" x 18"	120	50/200
051141-30694-0	1/4" x 24"	60	50/200
051119-05580-1	1/4" x 24"	80	50/200
051141-30695-7	1/4" x 24"	120	50/200
051111-68668-3	1/2" x 12"	60	50/200
051111-68695-9	1/2" x 12"	80	50/200
051141-30709-1	1/2" x 12"	120	50/200
051141-30686-5	1/2" x 18"	36	50/200
051119-63081-7	1/2" x 18"	60	50/200
051119-82035-5	1/2" x 18"	80	50/200
051141-30689-6	1/2" x 18"	120	50/200
051141-30693-3	1/2" x 24"	36	50/200
051111-68669-0	1/2" x 24"	60	50/200
051111-68696-6	1/2" x 24"	80	50/200
051111-69436-7	1/2" x 24"	120	50/200
051141-30687-2	3/4" x 18"	36	50/200
051115-19553-2	3/4" x 18"	60	50/200
051125-19076-3	3/4" x 18"	80	50/200
051141-30688-9	3/4" x 18"	120	50/200
051125-16745-1	3/4" x 20-1/2"	60	50/200
051111-68697-3	3/4" x 20-1/2"	80	50/200
051125-22333-1	3/4" x 20-1/2"	120	50/200
051119-71425-8	1" x 18"	60	50/200
051125-23878-6	1" x 18"	80	50/200
051141-30692-6	1" x 18"	120	50/200
051115-19554-9	2" x 48"	60	25/50
051119-05579-5	2" x 48"	80	25/50
051125-11238-3	2" x 48"	120	25/50
051141-30699-5	2" x 60"	36	25/50
051111-69103-8	2" x 60"	60	25/50
051141-30703-9	2" x 60"	80	25/50
051141-30704-6	2" x 60"	120	25/50
051141-30698-8	2" x 72"	36	25/50
051111-69104-5	2" x 72"	60	25/50
051141-30701-5	2" x 72"	80	25/50
051141-30697-1	2" x 72"	120	25/50

3M™ Belts

577F (cont.)

UPC	W x L	Grade	Qty./Case
051111-67602-8	2" x 132"	36	25/50
051141-30702-2	2" x 132"	50	25/50
051111-69105-2	2" x 132"	60	25/50
051111-69108-3	2" x 132"	80	25/50
051141-30696-4	2" x 132"	120	25/50
051119-64999-4	2-1/2" x 60"	36	25/50
051111-69106-9	2-1/2" x 60"	60	25/50
051125-12707-3	2-1/2" x 60"	80	25/50
051141-30706-0	2-1/2" x 60"	120	25/50
051111-69099-4	3" x 132"	36	25/50
051119-82066-9	3" x 132"	50	25/50
051111-69569-2	3" x 132"	60	25/50
051111-69571-5	3" x 132"	80	25/50
051111-67681-3	3" x 132"	120	25/50
051119-67701-0†	3-1/2" x 15-1/2"	60	50
051119-58968-9†	3-1/2" x 15-1/2"	80	50
051119-67700-3†	3-1/2" x 15-1/2"	120	50
051111-67604-2	4" x 132"	36	25
051115-27562-3	4" x 132"	50	25
051111-69570-8	4" x 132"	60	25
051111-69573-9	4" x 132"	80	25
051125-23987-5	4" x 132"	120	25
051111-69445-9	6" x 48"	60	20
051119-83855-8	6" x 48"	80	20
051141-30707-7	6" x 48"	120	20
051111-69440-4	37" x 60"	36	2
051111-68691-1	37" x 60"	60	2
051111-69111-3	37" x 60"	80	2
051111-69115-1	37" x 60"	120	5
051125-22740-7	37" x 60"	180	5
051119-61101-4	37" x 75"	36	2
051111-68692-8	37" x 75"	60	2
051111-69112-0	37" x 75"	80	2
051111-67688-2	37" x 75"	120	5
051125-09283-8	37" x 75"	180	5

† Made-to-Order

747D

- 3M ceramic aluminum oxide blend abrasive grain on an X wt. cloth backing
- Use for offhand heat sensitive stainless steel applications
- Grinding aid enhances performance on stainless steel and other exotic alloys
- Well suited for stroke sanding applications

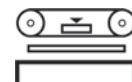

UPC	W x L	Grade	Qty./Case
051111-67749-0†	3" x 9-1/2"	50	200
051111-67759-9†	3" x 9-1/2"	60	200
051111-67789-6†	3" x 9-1/2"	P100	200
051111-67806-0†	3" x 9-1/2"	P120	200
051111-67807-7†	3" x 118"	P120	50
051115-27355-1†	3" x 132"	60	50
051111-68923-3†	3" x 132"	P120	50
051111-67751-3†	6" x 264"	50	10
051111-67766-7†	6" x 264"	60	10
051111-67778-0†	6" x 264"	80	20
051125-20535-1†	6" x 264"	P100	20
051111-67812-1†	6" x 264"	P120	20
051144-85846-0†	6" x 274"	60	20
051111-67779-7†	6" x 274"	80	20
051111-67767-4†	6" x 300"	60	10
051111-67781-0†	6" x 300"	80	20
051111-67813-8†	6" x 300"	P120	20
051115-19560-0†	6" x 355"	50	10
051111-67755-1†	6" x 360"	50	10

† Made-to-Order

777F

- 3M ceramic aluminum oxide blend abrasive grain on a YF wt. cloth backing
- Contains grinding aid which enhances performance on stainless steel and other exotic alloys
- For use on backstand, benchtop, flat finishing, slack of belt, centerless and dry roll grinding equipment
- Can be run wet or dry

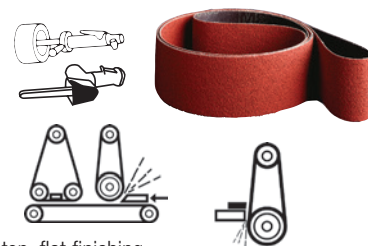

UPC	W x L	Grade	Qty./Case
051144-84403-6	1/4" x 18"	60	200
051144-85318-2	1/4" x 18"	80	200
051144-19579-2	1/4" x 18"	P120	200
051144-84412-8	1/4" x 24"	40	200
051144-80253-1	1/4" x 24"	60	200
051144-77642-9	1/4" x 24"	80	200
051144-82229-4	1/4" x 24"	P120	200
051111-69457-2	1/2" x 12"	60	200
051144-85372-4	1/2" x 12"	80	200
051111-69604-0	1/2" x 12"	P120	200

3M™ Belts

777F (cont.)

UPC	W x L	Grade	Qty./Case
051144-84301-5	1/2" x 18"	36	200
051144-84409-8	1/2" x 18"	40	200
051144-80551-8	1/2" x 18"	60	200
051144-80232-6	1/2" x 18"	80	200
051144-84304-6	1/2" x 18"	P120	200
051144-77643-6	1/2" x 24"	36	200
051144-82342-0	1/2" x 24"	40	200
051144-77408-1	1/2" x 24"	50	200
051144-77065-6	1/2" x 24"	60	200
051144-77491-3	1/2" x 24"	80	200
051144-81064-2	1/2" x 24"	P120	200
051144-84302-2	3/4" x 18"	36	200
051144-84404-3	3/4" x 18"	60	200
051144-77992-5	3/4" x 18"	80	200
051144-84303-9	3/4" x 18"	P120	200
051144-80486-3	3/4" x 20-1/2"	60	200
051144-80686-7	3/4" x 20-1/2"	80	200
051125-23897-7	1" x 18"	60	200
051144-85319-9	1" x 18"	80	200
051141-30705-3	1" x 18"	P120	200
051144-76527-0	1" x 42"	40	50/200
051144-77512-5	1" x 42"	60	50/200
051144-14895-0	1" x 42"	80	50/200
051144-84416-6	1-1/2" x 60"	60	25/50
051144-76731-1	1-1/2" x 60"	80	25/50
051144-82022-1	1-1/2" x 60"	P120	25/50
051144-76738-0	2" x 48"	36	10/50
051144-76519-5	2" x 48"	60	25/50
051144-14896-7	2" x 48"	80	25/50
051144-85393-9	2" x 48"	P120	50
051144-77663-4	2" x 60"	36	50
051144-77152-3	2" x 60"	60	50
051144-84296-4	2" x 60"	80	50
051144-85377-9	2" x 60"	P120	50
051144-76531-7	2" x 72"	36	50
051144-80286-9	2" x 72"	60	50
051144-14884-4	2" x 72"	80	50
051144-81767-2	2" x 72"	P120	50
051144-14264-4	2" x 132"	36	50
051144-14899-8	2" x 132"	50	50
051144-82231-7	2" x 132"	60	50
051144-14534-8	2" x 132"	80	50
051144-81687-3	2" x 132"	P120	50
051144-84315-2	2" x 132"	P180	50
051144-76532-4	2-1/2" x 60"	36	50
051144-77825-6	2-1/2" x 60"	40	50
051144-76680-2	2-1/2" x 60"	60	50
051144-76686-4	2-1/2" x 60"	80	50
051115-27389-6	2-1/2" x 60"	P120	50

777F (cont.)

UPC	W x L	Grade	Qty./Case
051144-76533-1	3" x 132"	36	25
051111-69455-8	3" x 132"	50	25
051144-76520-1	3" x 132"	60	25
051144-76514-0	3" x 132"	80	25
051144-80028-5	3" x 132"	P120	50
051144-85762-3	3" x 132"	P180	50
051144-77336-7	3-1/2" x 15-1/2"	36	50
051144-77334-3	3-1/2" x 15-1/2"	50	50
051144-77476-0	3-1/2" x 15-1/2"	60	50
051144-77333-6	3-1/2" x 15-1/2"	80	50
051144-84306-0	3-1/2" x 15-1/2"	100	50
051144-84307-7	3-1/2" x 15-1/2"	P120	50
051144-85320-5	3-1/2" x 15-1/2"	P180	50
051144-76534-8	4" x 132"	36	25
051111-67851-0	4" x 132"	50	25
051144-80707-9	4" x 132"	60	25
051144-76515-7	4" x 132"	80	25/50
051141-30700-8	4" x 132"	P120	25
051144-82313-0	6" x 48"	36	10/20
051144-80176-3	6" x 48"	50	10/20
051144-76679-6	6" x 48"	60	20
051144-76733-5	6" x 48"	80	20
051144-82153-2	6" x 48"	P120	20
051125-33828-8	37" x 60"	36	2
051115-27354-4	37" x 60"	60	2
051144-77351-0	37" x 60"	80	2
051144-80450-4	37" x 60"	P120	5
051111-69127-4	37" x 60"	P180	5
051119-75481-0	37" x 75"	36	2
051111-69122-9	37" x 75"	60	2
051144-82930-9	37" x 75"	80	2
051144-84947-5	37" x 75"	P120	5
051111-69128-1	37" x 75"	P180	5

3M™ Belts

963G

- 3M ceramic abrasive grain on a YN wt. cloth backing
- Water-resistant polyester cloth backing for heavy grinding
- For coarse grade power grinding
- Can be run wet or dry



UPC	W x L	Grade	Qty./Case
051144-74228-8†	2" x 132"	24	50
051111-68163-3	2" x 132"	60	50
051144-74229-5†	3" x 132"	24	25
051144-74207-3	3" x 132"	36 L-flex	25
051144-74324-7	3" x 132"	60	25
051144-13715-2	3" x 132"	80 L-flex	25
051111-68109-1†	4" x 132"	24	25
051144-74209-7	4" x 132"	36	25
051144-74330-8	4" x 132"	40	25
051144-74325-4	4" x 132"	60	25
051144-84491-3†	6" x 132"	36	10
051111-68168-8†	6" x 132"	60	20

† Made-to-Order

966F

- 3M ceramic abrasive grain on a YF wt. cloth backing
- Water-resistant polyester cloth backing
- Resin bonded for heat resistance
- Designed for wet centerless grinding applications on carbon steel, heat sensitive high nickel alloys, titanium and stainless steel
- Ideal for stripping chrome from old parts

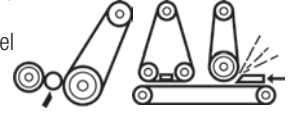

UPC	W x L	Grade	Qty./Case
051119-09003-1†	3" x 132"	36	25
051119-78104-5	4" x 132"	36	25
051119-10654-1†	4" x 132"	80	25
051119-78105-2†	4" x 132"	80 sine	25
051115-27128-1	4" x 132"	60	25
051111-68321-7†	9" x 120"	36	10
051115-27315-5	9" x 120"	50	10
051125-14381-3	9" x 120"	60	10
051111-68326-2†	9" x 120"	80	10
051115-27404-6†	9" x 120"	80 L-flex	20
051125-12989-3†	12 x 144"	40	5
051115-27990-4	12 x 144"	50	5
051119-83152-8†	12 x 144"	60	5
051135-13609-6		24	
051135-13660-7	Belt sizes made to order. Specify UPC, grade and belt size (W" x L")	36	Determined by belt size.
051135-13684-3		40	
051135-13683-6		50	
051135-13682-9		60	
051135-13681-2		80	

† Made-to-Order

Tech Tip

Keep Things Cool

When working on heat sensitive alloys like stainless steel, nickel alloys and cobalt alloys, choose a product with a grinding aid.

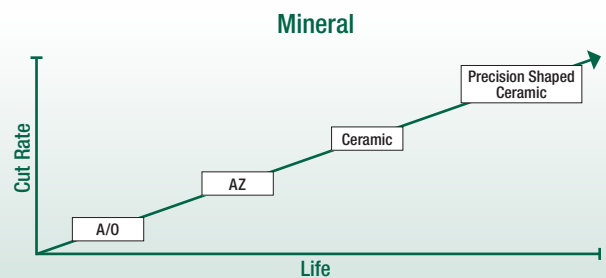
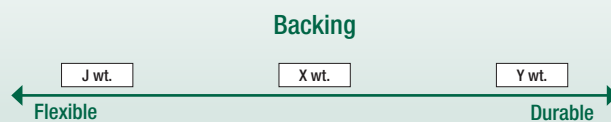

3M™ Belts

977F

- 3M ceramic abrasive grain on a YF wt. cloth backing
- Recommended for both wet or dry grinding of stainless steel and high nickel alloys
- For use on file belt and inline sanders, as well as centerless and dry roll grinding equipment
- Works well in all grinding pressures

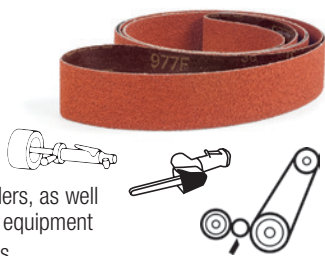

UPC	W x L	Grade	Qty./Case
051111-68989-9†	1" x 11"	60	500
051111-68602-7†	1" x 11"	80	500
051111-68527-3†	1" x 42"	40	200
051115-27684-2†	1" x 42"	120	200
051111-68530-3†	1" x 132"	40	100
051111-68548-8†	1" x 132"	50	100
051111-68583-9†	1" x 132"	60	200
051115-27336-0†	1" x 132"	80	200
051111-68532-7†	2" x 48"	40	50
051119-09500-5†	2" x 48"	60	50
051144-85389-2	2" x 72"	36	50
051111-69519-7†	2" x 72"	40	50
051111-68552-5†	2" x 72"	50	50
051144-85383-0	2" x 72"	60	50
051144-84008-3	2" x 72"	80	50
051111-69514-2	2" x 72"	120	50
051111-68534-1†	2" x 118"	40 L-flex	50
051111-68535-8†	2" x 118"	40	50
051144-83522-5	2" x 132"	36	50
051111-68537-2†	2" x 132"	40	50
051144-85015-0	2" x 132"	50	50
051144-85384-7	2" x 132"	60	50
051144-85769-2	2" x 132"	80	50
051111-68631-7†	2" x 132"	100	50
051111-68640-9†	2" x 132"	120	50
051111-68485-6†	3" x 132"	24	25
051111-68506-8†	3" x 132"	36 L-flex	25
051111-68507-5†	3" x 132"	36	25
051144-82798-5	3" x 132"	40	25
051111-68557-0†	3" x 132"	50 L-flex	25
051111-69165-6†	3" x 132"	50	25
051111-69166-3†	3" x 132"	60	25
051119-08175-6†	3" x 132"	60 full flex	25
051144-85378-6	3" x 132"	80	25
051119-77855-7†	3" x 132"	100	50
051111-68645-4†	3" x 132"	120	50
051111-69522-7†	3-1/2" x 15-1/2"	60	50
051125-18646-9†	3-1/2" x 15-1/2"	80	50
051125-23841-0†	3-1/2" x 15-1/2"	100	50
051111-68593-8†	4" x 90"	60	50
051125-10597-2†	4" x 90"	80	50
051125-11234-5†	4" x 90"	120	50

† Made-to-Order

977F (cont.)

UPC	W x L	Grade	Qty./Case
051144-85390-8†	4" x 132"	36 L-flex	25
051111-68511-2†	4" x 132"	36	25
051119-65751-7†	4" x 132"	40	25
051125-15945-6†	4" x 132"	40 full flex	25
051111-69351-3†	4" x 132"	50	25
051111-69352-0†	4" x 132"	50 L-flex	25
051115-27540-1†	4" x 132"	60	25
051111-68594-5†	4" x 132"	60 L-flex	25
051111-68619-5†	4" x 132"	80	25
051144-85387-8†	6" x 132"	40 L-flex	20
051125-17018-5†	6" x 132"	40 full flex	20
051111-68518-1†	6" x 132"	36 sine	10
051115-19611-9†	6" x 132"	36 film	10
051111-68596-9†	6" x 132"	60	20
051115-27541-8†	6" x 132"	80	20
051111-68524-2†	8" x 132"	36	20
051111-68597-6†	8" x 132"	60	20

† Made-to-Order

Scotch-Brite™ Surface Conditioning Belts

The easiest way to a perfect finish. Choose Scotch-Brite™ Surface Conditioning Belts for cleaning, finishing, blending and deburring. The reinforced backing offers good flexibility whether working on a file belt or backstand. The non-woven material combined with abrasive grain is an ideal way to add a great finish or remove burrs without gouging or undercutting the work piece. Trust Scotch-Brite™ Belts to deliver fantastic finishes.

Scotch-Brite™ Surface Conditioning Belt Selection Guide

Metal Type	Performance	Application			
		Blending	Deburring	Finishing	Cleaning
Stainless Steel, Carbon Steel, Titanium, Nickel Alloy	Good	SE	SC	SE	SE
	Better	SC, SL	DF, SL	SC, SL	DF, SL
	Best	DF, LGB	SE, LGB	DF	SC
Aluminum, Copper, Brass (Soft Metals), Non-Ferrous Metals	Good	DF, LGB	DF, LGB	DF	DF
	Better	SC	SC	SC	SC
	Best	PD	PD	PD	PD

Scotch-Brite™ Surface Conditioning Belt Availability Guide

3M ID	Backing	SD CRS (Super Duty)	HD CRS (Heavy Duty)	A CRS	A MED	A FIN	A VFN	SFN
DF	Low Stretch			•	•	•		
	Scrim			•	•		•	•
SC	Low Stretch			•	•		•	•
	Film Backed			•	•		•	•
SE	Scrim			•	•	•		
	Low Stretch			•	•	•		
PD	Film Backed			•	•			
	Scrim			•	•			
SL	Low Stretch			•	•			
	Film Backed			•	•			
LGB	Scrim	•	•	•	•			
	Low Stretch	•	•					
	Film Backed							

Legend		
DF = DF Surface Conditioning Belts	SC = SC Surface Conditioning Belts	SL = SL Surface Conditioning Belts
PD = PD Surface Conditioning Belts	SE = SE Surface Conditioning Belts	LGB = Light Grinding and Blending Belts

Performance



SCOTCH-BRITE™ BELTS RECOMMENDED OPERATING SPEEDS

Application	Recommended SFPM
Decorative Finishing	500–3,000 SFPM
Deburring	5,000–6,500 SFPM
Cleaning and Conditioning	2,000–5,000 SFPM
Oxide Removal	4,500–6,500 SFPM
Maximum Operating Speed: 6,500 SFPM	SFPM = Surface Feet Per Minute

Scotch-Brite™ Surface Conditioning Belts

Scotch-Brite™ SE Surface Conditioning Belt

- Coarse, tough, aggressive non-woven belt for heavy duty deburring and finishing
- For use on backstand and off hand equipment
- Reinforced backing offers good flexibility
- Abrasive mineral: coarse grade aluminum oxide
- Color: Brown/blue

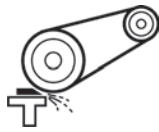

UPC	W x L	Grade	Qty./Case
048011-18495-1	1/4" x 18"	A CRS	20
048011-18496-8†	1/4" x 24"	A CRS	20
048011-18087-8	1/2" x 18"	A CRS	20
048011-18088-5	1/2" x 24"	A CRS	20
048011-19697-8	3/4" x 18"	A CRS	20
048011-18089-2	3-1/2" x 15-1/2"	A CRS	10

† Made-to-Order

Scotch-Brite™ SC Surface Conditioning Belts

- Premium Scotch-Brite surface conditioning non-woven web
- Designed for cleaning, finishing and light deburring
- For use on portable, benchtop and backstand equipment

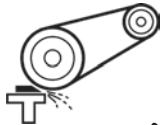

UPC	W x L	Grade	Color	Qty./Case
048011-13290-7†	1/4" x 18"	A CRS	Brown	20
048011-14276-0	1/4" x 18"	A MED	Maroon	20
048011-13230-3†	1/4" x 18"	A VFN	Blue	20
048011-13132-0	1/4" x 24"	A CRS	Brown	20
048011-13131-3	1/4" x 24"	A MED	Maroon	20
048011-13287-7	1/4" x 24"	A VFN	Blue	20
048011-08858-7	1/2" x 18"	A CRS	Brown	20
048011-08857-0	1/2" x 18"	A MED	Maroon	20
048011-08856-3	1/2" x 18"	A VFN	Blue	20
048011-05741-5	1/2" x 24"	A CRS	Brown	20
048011-03998-5	1/2" x 24"	A MED	Maroon	20
048011-04299-2	1/2" x 24"	A VFN	Blue	20
048011-13639-4	3/4" x 18"	A CRS	Brown	20
048011-15899-0	3/4" x 18"	A MED	Maroon	20
048011-14543-3	3/4" x 18"	A VFN	Blue	20

Scotch-Brite™ SC Surface Conditioning Belts (cont.)

UPC	W x L	Grade	Color	Qty./Case
048011-14278-4	1" x 18"	A CRS	Brown	10
048011-14398-9†	1" x 18"	A MED	Maroon	10
048011-17517-1†	1" x 18"	A VFN	Blue	10
048011-04189-6	1" x 42"	A MED	Maroon	10
048011-04190-2	1" x 42"	A VFN	Blue	10
048011-08913-3†	1" x 132"	A MED	Maroon	5
048011-08915-7	2" x 48"	A MED	Maroon	10
048011-04295-4	2" x 48"	A VFN	Blue	10
048011-08883-9†	2" x 72"	A CRS	Brown	10
048011-00580-5	2" x 72"	A MED	Maroon	10
048011-00579-9	2" x 72"	A VFN	Blue	10
048011-03999-2	2" x 132"	A MED	Maroon	5
048011-04297-8	2" x 132"	A VFN	Blue	5
048011-05022-5	2-3/4" x 15-1/2"	A CRS	Brown	10
048011-05227-4	2-3/4" x 15-1/2"	A MED	Maroon	10
048011-05820-7	3" x 10-11/16"	A CRS	Brown	10
048011-05783-5	3" x 10-11/16"	A MED	Maroon	10
048011-09650-6	3" x 10-11/16"	A VFN	Blue	10
048011-14284-5†	3" x 18"	A CRS	Brown	10
048011-14285-2	3" x 18"	A MED	Maroon	10
048011-14550-1	3" x 18"	A VFN	Blue	10
048011-08880-8	3" x 24"	A CRS	Brown	10
048011-00583-6	3" x 24"	A MED	Maroon	10
048011-04298-5	3" x 24"	A VFN	Blue	10
048011-05023-2	3" x 132"	A CRS	Brown	5
048011-00568-3	3" x 132"	A MED	Maroon	5
048011-04289-3	3" x 132"	A VFN	Blue	5
048011-05016-4	3-1/2" x 15-1/2"	A CRS	Brown	10
048011-05228-1	3-1/2" x 15-1/2"	A MED	Maroon	10
048011-05643-2	3-1/2" x 15-1/2"	A VFN	Blue	10
048011-08882-2†	4" x 24"	A CRS	Brown	10
048011-00585-0†	4" x 24"	A MED	Maroon	10
048011-05018-8†	4" x 132"	A CRS	Brown	5
048011-00570-6	4" x 132"	A MED	Maroon	5
048011-04281-7	4" x 132"	A VFN	Blue	5
048011-05019-5	6" x 48"	A CRS	Brown	5
048011-00590-4	6" x 48"	A MED	Maroon	5
048011-04283-1	6" x 48"	A VFN	Blue	5

† Made-to-Order

Attention: Belts are available in other grades and sizes. If you need a specific belt not listed, contact your 3M Sales Specialist or 3M Authorized Distributor.

Scotch-Brite™ Surface Conditioning Belts

Scotch-Brite™ Durable Flex (DF) Surface Conditioning Belt

- Durable flex belt has great edge durability
- Aggressive and long lasting non-woven belt for deburring, finishing, blending and cleaning
- The reinforced low-stretch backing offers good flexibility



UPC	W x L	Grade	Color	Qty./Case
048011-64472-1	1/4" x 18"	A CRS	Brown	20
048011-64455-4	1/4" x 18"	A MED	Maroon	20
048011-64464-6	1/4" x 18"	A FIN	Green	20
048011-64473-8	1/4" x 24"	A CRS	Brown	20
048011-64456-1	1/4" x 24"	A MED	Maroon	20
048011-64465-3	1/4" x 24"	A FIN	Green	20
048011-64474-5	1/2" x 12"	A CRS	Brown	20
048011-64457-8	1/2" x 12"	A MED	Maroon	20
048011-64466-0	1/2" x 12"	A FIN	Green	20
048011-64475-2	1/2" x 18"	A CRS	Brown	20
048011-64458-5	1/2" x 18"	A MED	Maroon	20
048011-64467-7	1/2" x 18"	A FIN	Green	20
048011-64476-9	1/2" x 24"	A CRS	Brown	20
048011-64459-2	1/2" x 24"	A MED	Maroon	20
048011-64468-4	1/2" x 24"	A FIN	Green	20
048011-64477-6	3/4" x 18"	A CRS	Brown	20
048011-64460-8	3/4" x 18"	A MED	Maroon	20
048011-64469-1	3/4" x 18"	A FIN	Green	20
048011-64489-9	2-3/4" x 15-1/2"	A CRS	Brown	10
048011-64482-0	2-3/4" x 15-1/2"	A MED	Maroon	10
048011-64486-8	3" x 10-11/16"	A CRS	Brown	10
048011-64480-6	3" x 10-11/16"	A MED	Maroon	10
048011-64488-2	3" x 18"	A CRS	Brown	10
048011-64483-7	3" x 18"	A MED	Maroon	10
048011-64484-4	3" x 18"	A FIN	Green	10
048011-64487-5	3" x 24"	A CRS	Brown	10
048011-64481-3	3" x 24"	A MED	Maroon	10
048011-64485-1	3" x 24"	A FIN	Green	10
048011-64479-0	3" x 132"	A CRS	Brown	5
048011-64462-2	3" x 132"	A MED	Maroon	5
048011-64471-4	3" x 132"	A FIN	Green	5
048011-64478-3	3-1/2" x 15-1/2"	A CRS	Brown	10
048011-64461-5	3-1/2" x 15-1/2"	A MED	Maroon	10
048011-64470-7	3-1/2" x 15-1/2"	A FIN	Green	10

Scotch-Brite™ PD Surface Conditioning Belt

- Aluminum oxide abrasive mineral
- Open woven belt resistant to loading on soft and/or oily materials
- Reinforced backing offers good flexibility



UPC	Grade	Color	W x L	Qty./Case
048011-92126-6	A CRS	Brown	Belt sizes made to order. Specify UPC, grade and belt size (W" x L"). Belts wider than 25" require multiple splices.	Determined by belt size.
048011-92125-9	A CRS	Brown		
048011-92127-3	A CRS	Brown		
048011-92259-1	A MED	Maroon		

Scotch-Brite™ SL Surface Conditioning Belt

- Durable non-woven abrasive belt
- Blends and finishes consistently, often in one step
- Reduces loading
- Very forgiving
- Abrasive mineral: aluminum oxide



UPC	Grade	Color	W x L	Qty./Case
048011-64698-5	HD A CRS	Dark Brown	Belt sizes made to order. Specify UPC, grade and belt size (W" x L").	Determined by belt size.
048011-64606-0	SD A CRS	Dark Gray		

Scotch-Brite™ Light Grinding and Blending Belts

- A coarse, tough, aggressive non-woven belt for heavy duty deburring and finishing
- Tough enough to grind
- Can grind and blend in single step
- Resist edge wear
- Long life
- Abrasive mineral: ceramic grain



UPC	Grade	Color	W x L	Qty./Case
048011-64687-9	HD A CRS	Dark Pink	Belt sizes made to order. Specify UPC, grade and belt size (W" x L").	Determined by belt size.
048011-64688-6	SD A CRS	Dark Blue		

Attention: Belts are available in other grades and sizes. If you need a specific belt not listed, contact your 3M Sales Specialist or 3M Authorized Distributor.

3M™ Power Tools for Abrasive Belt Systems

3M™ File Belt Sander and Kit*

- Ideally suited for use with 3M™ Abrasive Belts and Scotch-Brite™ Belts for a variety of metalworking applications
- Grind and blend from contact wheel or platen finish and polish from slack of belt
- Provides access to hard-to-reach areas
- Eight different attachment arms available



Model No.	Motor	Max RPM	Belt Speed SFPM (SMM)	Weight Pound (kg)	Length Inch (mm)	Height Inch (mm)	Width Inch (mm)	Airflow Rate SCFM (LPM)	UPC
28366	0.6 HP	22,000	4990 (1521)	2.8 (1.3)	14.57 (370)	2.93 (74.5)	5.95 (151.2)	28 (793)	051141-28366-1
28367	Kit includes Molded Case, File Belt Sander (PN28366) and two Attachment Arms (PNs 28368, 28370)*								051141-28367-8

*For file belt sander attachment arms, see page 67.

3M™ Inline Sanders

- Generate straight-line scratches for finishing stainless steel and other metals
- Can be used with inflatable or slotted wheel accessories and many other wheel products



Model No.	Motor HP (W)	Max RPM	Weight Pound (kg)	Length Inch (mm)	Air Inlet Thread	Airflow Rate SCFM (LPM)	Shaft Size	UPC
28338	1 (744)	1,600	3.32 (1.51)	9.88 (251)	1/4" NPT	37 (1,048)	5/8"-11 EXT	051141-28338-8
28339	1 (744)	3,500	2.64 (1.20)	8.50 (216)	1/4" NPT	37 (1,048)	5/8"-11 EXT	051141-28339-5

3M™ Match and Finish Sander

- Generate straight-line scratches for finishing stainless steel and other metals
- Front to back motion helps prevent curved scratches
- Easy to control for reduced start/stop marks
- Easy screw-on/screw-off attachments
- Design for use with Scotch-Brite™ Match and Finish Flap Brushes, 3M™ Abrasive Belts or Scotch-Brite™ Belts*



Model No.	Motor HP (W)	Max RPM	Weight Pound (kg)	Length Inch (mm)	Air Inlet Thread	Airflow Rate SCFM (LPM)	Shaft Size	UPC
28659	1 (744)	3,500	4.6 (2.1)	13.5 (343)	1/4" NPT	37 (1,048)	5/8"-11 EXT	051141-28659-4

*To run belt products, 3M™ Expander Wheel (28718) and Adapter Kit (28719) are required. See page 68.

Accessories for Abrasive Belt Systems

3M™ File Belt Sander Platen Pad Material

Part No.	Size	For Use With	Description	UPC	Case Quantity
28377	1/2" x 7" x 1/8"	1/2" wide belts	Soft	051141-28377-7	10
28378	3/4" x 7" x 1/8"	5/8" or 3/4" wide belts	Soft	051141-28378-4	10
28379	1/2" x 7" x 1/8"	1/2" wide belts	Hard	051141-28379-1	10
28380	3/4" x 7" x 1/8"	5/8" or 3/4" wide belts	Hard	051141-28380-7	10
28381	1/2" x 7" x 1/32"	1/2" wide belts	Thin	051141-28381-4	10
28382	3/4" x 7" x 1/32"	5/8" or 3/4" wide belts	Thin	051141-28382-1	10



3M™ File Belt Arm Service Tool Kit









Part No.	Description	UPC	Case Quantity
30670	Contains Wheel Positioning Block, Shaft Removal Tool, 2 Bearing Removal Tools, Bearing Mount Tool, Bearing Tool and Retaining Compound	051141-30670-4	1

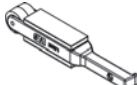

Accessories for Abrasive Belt Systems



3M™ File Belt Sander Attachment Arms

	Part No.	Use With Belt Size	Description	UPC	Case Quantity
	28368	1/2" x 18"	Standard Style: Standard arm included with 3M™ File Belt Sander (PN28366). Sand with contact wheel or platen.	051141-28368-5	1
	28369	1/2" x 18"	Thin Style: Thinner than standard arm. Sand with contact wheel or platen.	051141-28369-2	1
	28370	1/8" x 18" 1/4" x 18" 1/2" x 18"	Corners Style: Sand corners and grooves with contact wheel. Accommodates three belt widths.	051141-28370-8	1
	28371	5/8" x 18" 3/4" x 18"	Thick Standard Style: Thicker than standard arm. Sand with contact wheel or platen. Accommodates two belt widths.	051141-28371-5	1
	28372	1/8" x 18" 1/4" x 18"	Corners Style: Sand corners and grooves with contact wheel. Accommodates two belt widths.	051141-28372-2	1
	28373	5/8" x 20-1/2" 3/4" x 20-1/2"	20-1/2" Arm: Sand with contact wheel or platen. Accommodates two belt widths.	051141-28373-9	1
	28374	1/2" x 18"	Curved Arm: Unique curved arm used for blending flat areas. Sand with contact wheel or platen.	051141-28374-6	1
	28375	1/4" x 24" 1/2" x 24"	Vessel Arm: Unique large arm used for blending weld seams. Sand with 4" contact wheel. Includes tracking/control knob. Accommodates two belt widths.	051141-28375-3	1
	28376		Sander Extension: Use to extend arms to 24" length. Can be used with same attachment arm used for 18" length arms.	051141-28376-0	1

3M™ File Belt Attachment Arm Repair Kits

Kits contain: Contact wheel, bearing, shaft and platen pad if applicable. 3M™ File Belt Arm Service Tool Kit (PN30670) recommended for use with repair kits.

Attachment Arm Repair Kit Part No.	For Use With Attachment Arm Part No.
30663	28368
30667	28369
30668	28370
30664	28371
30666	28372
30665	28373
30662	28374
30669	28375

Accessories for Abrasive Belt Systems

Product Name	UPC	Qty./Case	For Use With	Size/Description	Max RPM
	051144-77717-4	1	Slotted wheels for use with bands	1" x 1" x 1/4"	18,000
	051144-77718-1	1		1-1/2" x 1" x 1/4"	14,000
	051144-77720-4	1		2" x 1" x 1/4"	12,000
	051144-77721-1	1		2" x 2" x 1/4"	6,000
	051144-77722-8	1		3" x 3" x 5/8-INT	6,000
Use 3M™ Wheel Adapter Kits to mount wheel to inline sander					
	051141-28348-7	1	For use with belts 3-1/2" x 15-1/2" or 3" x 10-11/16"	5" x 3-1/2" 5/8" Arbor Hole	3,500
	051141-28349-4	1		3-1/4" x 3" 5/8" Arbor Hole	3,500
3M™ Match and Finish Rubber Slotted Expander Wheels	Use 3M™ Expander Wheel and Adapter Kit with 3M™ Match and Finish Sander NEW!				
	051141-28718-8	1	3-1/2" x 15-1/2" belts	5" x 3-1/2" x 1" AH	3,500
	051141-27819-5	1	To mount 28718 wheel on 3M™ Match and Finish Sander	1" x 5/8-11 INT	N/A
Rubber Cushion Polishing Wheels	051144-45159-3	1	Use with bands when creating fine finishes	1/4" x 1/2" x 1/8"	23,000
	051144-45156-2	1		1/2" x 1/2" x 1/4"	30,000
	051144-45153-1	1		1/2" x 1" x 1/4"	15,000
	051144-45152-4	1		1/2" x 1-1/2" x 1/4"	15,000
	051144-45145-6	1		3/4" x 1" x 1/4"	17,000
	051144-45144-9	1		3/4" x 1-1/2" x 1/4"	10,000
	051144-45139-5	1		1" x 1" x 1/4"	18,000
	051144-45138-8	1		1" x 1-1/2" x 1/4"	10,000
	051144-45132-6	1		1-1/2" x 1" x 1/4"	14,000
	051144-45131-9	1		1-1/2" x 1-1/2" x 1/4"	10,000
	051144-45130-2	1		1-1/2" x 2" x 1/4"	8,000
	051144-45129-6	1		2" x 1" x 1/4"	11,000
	051144-45127-2	1		2" x 2" x 1/4"	6,000
	051144-45124-1	1		3" x 3" x 3/8"	3,000
	051144-45123-4	1		3" x 3" x 1/2"	3,000

Abrasive Wheel Systems

For Deburring, Weld Blending, Finishing and More!



Scotch-Brite™ Convolute Wheels

Scotch-Brite™ Convolute Wheels

Get high performance and durability in a variety of cleaning, deburring, finishing and polishing applications. Used on right angle grinders and bench tools, Scotch-Brite™ Wheels produce great results on all types of metal, composites and glass.

Convolute Wheels Selection Guides

Scotch-Brite™ Convolute Wheel performance differences can be attributed to mineral (aggressiveness) and density (hardness). The combination of these two characteristics and subtle variations determine if the wheel will cut more aggressively or will be more durable and less conformable.

Least Aggressive	
	Light Deburring Wheels (FIN)
	General Deburring Wheel (9S FIN*)
	EXL/EX2/EX3 Deburring Wheels (8S FIN*, 9S FIN*, A MED)
	EXL-PRO Deburring Wheels (S FIN)
	Multi-Finishing Wheels (FIN, MED, CRS)
	Metal Finishing Wheels (MED, CRS)
	Cut and Polish Wheels (VFN, FIN, MED, CRS)
Most Aggressive	

*Numeric designators (8/9) represent mineral aggressiveness; not density.

Softest	
	Multi-Finishing Wheels (2, 3, 4)
	Metal Finishing Wheels (4, 5, 6)
	Light Deburring Wheels (6, 7, 8)
	EXL-PRO Deburring Wheels (9, 10, 11)
	General Deburring Wheel
	EXL/EX2/EX3 Deburring Wheels
	Cut and Polish Wheels (5, 7, 9)
Hardest	

Mineral Abbreviations (prefix to grade)	
A — Aluminum Oxide mineral	S — Silicon Carbide mineral

Density Number (prefix to mineral)							
soft ←						→ hard	
2	4	6	7	8	9	10	11

Scotch-Brite™ Convolute Wheel	Application				
	Cleaning	Deburring	Blending	Finishing	Polishing
3M General Deburring		•		•	
EXL/EX2/EX3 Deburring		•	•	•	
Metal Finishing	•		•	•	
Cut and Polish			•	•	•
Multi-Finishing	•		•	•	
Light Deburring				•	•
EXL-PRO Deburring		•			

Scotch-Brite™ Convolute Wheels for Deburring

Scotch-Brite™ EXL-PRO Deburring Wheels

- Optimized performance, particularly in off-hand applications
- Longest life of any Scotch-Brite™ Deburring Wheel
- Smooth, even wear — helps control the workpiece
- More cut, with less pressure required — without sacrificing finish
- Easy to use, comfortable for operators



UPC	Dia. x W x AH	Grade	Max. RPM	Qty./Case
051125-94904-5	6" x 1/2" x 1"	9S FIN	6,000	4
051125-94905-2	6" x 1" x 1"	9S FIN	6,000	3
051125-94907-1	8" x 1/2" x 3"	9S FIN	4,500	4
051125-94908-8	8" x 1" x 3"	9S FIN	4,500	3
051125-94913-2	12" x 1" x 5"	9S FIN	3,000	1
051125-94914-9	12" x 2" x 5"	9S FIN	3,000	1
051125-94926-7	6" x 1/2" x 1"	10S FIN	6,000	4
051125-94917-0	6" x 1" x 1"	10S FIN	6,000	3
051125-94927-4	8" x 1/2" x 3"	10S FIN	4,500	4
051125-94918-7	8" x 1" x 3"	10S FIN	4,500	3
051125-94902-6	12" x 1" x 5"	10S FIN	3,000	1

Other sizes available in 9 and 10 densities.

Scotch-Brite™ EXL, EX2 and EX3 Deburring Wheels

- Versatile wheel offers reliable performance and great value
- Full line of densities, grades and sizes for any deburring or finishing application
- Use to clean, finish, blend, deburr or polish all types of metals, composites and glass



UPC	Size	Grade	Max. RPM	Qty./Case
EXL				
048011-13616-5	6" x 1/2" x 1"	8A MED	6,000	4
048011-09548-6	6" x 1/2" x 1"	8S FIN	6,000	4
048011-05790-3	6" x 1/2" x 1"	9S FIN	6,000	4
048011-13617-2	6" x 1" x 1"	8A MED	6,000	3
048011-18278-0	6" x 1" x 1"	8S MED	6,000	3
048011-09549-3	6" x 1" x 1"	8S FIN	6,000	3
048011-05132-1	6" x 1" x 1"	9S FIN	6,000	3
048011-13618-9	6" x 2" x 1"	8A MED	6,000	2
048011-05133-8	6" x 2" x 1"	9S FIN	6,000	2
048011-14791-8	8" x 3/8" x 3"	8S FIN	4,500	4
048011-17459-4	8" x 1/2" x 3"	8A MED	4,500	4
048011-14629-4	8" x 1/2" x 3"	8S FIN	4,500	4
048011-05791-0	8" x 1/2" x 3"	9S FIN	4,500	4
048011-13619-6	8" x 1" x 3"	8A MED	4,500	3
048011-18279-7	8" x 1" x 3"	8S MED	4,500	3
048011-09551-6	8" x 1" x 3"	8S FIN	4,500	3
048011-05135-2	8" x 1" x 3"	9S FIN	4,500	3
048011-13620-2	8" x 2" x 3"	8A MED	4,500	2
048011-09552-3	8" x 2" x 3"	8S FIN	4,500	2
048011-05136-9	8" x 2" x 3"	9S FIN	4,500	2

Scotch-Brite™ EXL, EX2 and EX3 Deburring Wheels (cont.)

UPC	Size	Grade	Max. RPM	Qty./Case
EXL (cont.)				
048011-05137-6	10" x 1" x 5"	9S FIN	3,600	2
048011-15641-5	12" x 1/2" x 5"	8S FIN	3,000	2
048011-09005-4	12" x 1/2" x 5"	9S FIN	3,000	2
048011-13621-9	12" x 1" x 5"	8A MED	3,000	1
048011-18281-0	12" x 1" x 5"	8S MED	3,000	1
048011-09554-7	12" x 1" x 5"	8S FIN	3,000	1
048011-05138-3	12" x 1" x 5"	9S FIN	3,000	1
048011-13622-6	12" x 2" x 5"	8A MED	3,000	1
048011-09555-4	12" x 2" x 5"	8S FIN	3,000	1
048011-05139-0	12" x 2" x 5"	9S FIN	3,000	1
048011-13623-3	14" x 2" x 8"	8A MED	2,550	1
048011-05141-3	14" x 2" x 8"	9S FIN	2,550	1
EX2				
048011-17215-6	6" x 1/2" x 1"	8A MED	6,000	4
048011-18285-8	6" x 1/2" x 1"	8S MED	6,000	4
048011-17216-3	6" x 1/2" x 1"	8S FIN	6,000	4
048011-24532-4	6" x 1/2" x 1"	9S FIN	6,000	4
048011-17217-0	6" x 1" x 1"	8A MED	6,000	3
048011-18286-5	6" x 1" x 1"	8S MED	6,000	3
048011-17218-7	6" x 1" x 1"	8S FIN	6,000	3
048011-18040-3	6" x 1" x 1"	9S FIN	6,000	3
048011-17426-6	8" x 1/2" x 3"	8A MED	4,500	4
048011-17425-9	8" x 1/2" x 3"	8S FIN	4,500	4
048011-17219-4	8" x 1" x 3"	8A MED	4,500	3
048011-17220-0	8" x 1" x 3"	8S FIN	4,500	3
048011-18365-7	8" x 1" x 3"	9S FIN	4,500	3
048011-17223-1	12" x 1" x 5"	8A MED	3,000	1
048011-17224-8	12" x 1" x 5"	8S FIN	3,000	1
EX3				
048011-24026-8	6" x 1/2" x 1"	9S FIN	6,000	4
048011-18825-6	6" x 1" x 1"	9S FIN	6,000	3
048011-24527-0	8" x 1" x 3"	9S FIN	4,500	3
048011-18826-3	12" x 2" x 5"	9S FIN	3,000	1

3M™ General Deburring Wheels

- Soft construction for better conformability and more operator comfort
- For light or medium deburring, radiusing, finishing and cleaning applications
- Great price-value for general purpose needs
- All wheels are stocked and available in single package quantities



UPC	Dia. x W x CH	Grade	Max. RPM	Qty./Case
048011-64899-6	6" x 1/2" x 1"	9S FIN	6,000	5
048011-64900-9	6" x 1" x 1"	9S FIN	6,000	5
048011-64901-6	8" x 1/2" x 3"	9S FIN	4,500	5
048011-64902-3	8" x 1" x 3"	9S FIN	4,500	5

Attention: Wheels are available in other grades and sizes. If you need a specific wheel not listed, contact your 3M Sales Specialist or 3M Authorized Distributor.

Scotch-Brite™ Convolute Wheels for Finishing

Scotch-Brite™ Metal Finishing Wheels

- For decorative finishing and blending of all metals
- Creates a consistent satin finish
- Good conformability
- Produces a coarser and duller finish than Light Deburring Wheels
- Removes minor imperfections and handling marks



UPC	Size	Grade	Max. RPM	Qty./Case
048011-05394-3†	6" x 1/2" x 1"	6A CRS	6,000	4
048011-05391-2†	6" x 1/2" x 1"	5A MED	6,000	4
048011-01861-4	6" x 1" x 1"	4A CRS	6,000	3
048011-01863-8	6" x 1" x 1"	5A CRS	6,000	3
048011-01866-9	6" x 1" x 1"	6A CRS	6,000	3
048011-01860-7†	6" x 1" x 1"	4A MED	6,000	3
048011-01862-1	6" x 1" x 1"	5A MED	6,000	3
048011-01865-2	6" x 1" x 1"	6A MED	6,000	3
048011-30012-2†	6" x 1" x 1-1/4"	5A CRS	6,000	3
048011-24110-4†	6" x 1" x 1-1/4"	5A MED	6,000	3
048011-01868-3	6" x 2" x 1"	4A CRS	6,000	2
048011-01888-1	6" x 2" x 1"	5A CRS	6,000	2
048011-01870-6†	6" x 2" x 1"	6A CRS	6,000	2
048011-01867-6	6" x 2" x 1"	4A MED	6,000	2
048011-01869-0	6" x 2" x 1"	5A MED	6,000	2
048011-01889-8†	6" x 2" x 1"	6A MED	6,000	2
048011-01891-1†	6" x 3" x 1"	4A CRS	6,000	1
048011-08891-4†	6" x 4" x 1"	4A MED	6,000	1
048011-09118-1†	6" x 6" x 1"	5A CRS	6,000	1
048011-14336-1†	8" x 1/2" x 3"	5A CRS	4,500	4
048011-16449-6†	8" x 1/2" x 3"	5A MED	4,500	4
048011-05414-8†	8" x 1" x 3"	4A CRS	4,500	3
048011-01872-0	8" x 1" x 3"	5A CRS	4,500	3
048011-01901-7	8" x 1" x 3"	6A CRS	4,500	3
048011-08926-3†	8" x 1" x 3"	4A MED	4,500	3
048011-01871-3	8" x 1" x 3"	5A MED	4,500	3
048011-01900-0†	8" x 1" x 3"	6A MED	4,500	3
048011-92896-8†	8" x 1-1/2" x 3"	5A CRS	4,500	2
048011-01875-1†	8" x 2" x 3"	4A CRS	4,500	2
048011-01904-8	8" x 2" x 3"	5A CRS	4,500	2
048011-13453-6†	8" x 2" x 3"	6A CRS	4,500	2
048011-01874-4	8" x 2" x 3"	4A MED	4,500	2
048011-01876-8	8" x 2" x 3"	5A MED	4,500	2
048011-01905-5†	8" x 2" x 3"	6A MED	4,500	2
048011-15608-8†	8" x 3" x 3"	5A CRS	4,500	1
048011-13451-2†	8" x 3" x 3"	6A CRS	4,500	1
048011-13452-9†	8" x 3" x 3"	4A MED	4,500	1
048011-05395-0†	8" x 3" x 3"	5A MED	4,500	1
048011-25612-2†	8" x 3" x 3"	6A MED	4,500	1

† Made-to-Order

Scotch-Brite™ Metal Finishing Wheels (cont.)

UPC	Size	Grade	Max. RPM	Qty./Case
048011-15607-1†	12" x 1/2" x 5"	5A MED	3,000	2
048011-05398-1†	12" x 1" x 5"	5A CRS	3,000	1
048011-15062-8†	12" x 1" x 5"	6A CRS	3,000	1
048011-01916-1	12" x 1" x 5"	5A MED	3,000	1
048011-08924-9†	12" x 1" x 5"	6A MED	3,000	1
048011-25619-1†	12" x 1-1/4" x 5"	6A MED	3,000	1
048011-25621-4†	12" x 1-1/2" x 5"	6A CRS	3,000	1
048011-15326-1†	12" x 1-1/2" x 5"	5A MED	3,000	1
048011-09612-4†	12" x 2" x 5"	4A CRS	3,000	1
048011-13449-9	12" x 2" x 5"	5A CRS	3,000	1
048011-13448-2†	12" x 2" x 5"	6A CRS	3,000	1
048011-01921-5†	12" x 2" x 5"	4A MED	3,000	1
048011-01882-9	12" x 2" x 5"	5A MED	3,000	1
048011-14617-1†	12" x 2" x 5"	6A MED	3,000	1
048011-13446-8†	12" x 3" x 5"	4A CRS	3,000	1
048011-08902-7†	12" x 3" x 5"	5A CRS	3,000	1
048011-92916-3†	12" x 3" x 5"	4A MED	3,000	1
048011-08929-4†	12" x 3" x 5"	5A MED	3,000	1
048011-16422-9†	12" x 3-1/2" x 5"	5A MED	3,000	1
048011-13445-1†	12" x 4" x 5"	4A CRS	3,000	1
048011-13071-2†	12" x 4" x 5"	5A CRS	3,000	1
048011-18634-4†	12" x 4" x 5"	6A CRS	3,000	1
048011-25615-3†	12" x 4" x 5"	4A MED	3,000	1
048011-05392-9†	12" x 4" x 5"	5A MED	3,000	1

† Made-to-Order

Scotch-Brite™ Multi-Finishing Wheels

- For decorative, satin finishing and blending of all metals
- Often used on inline sanding tools for large surface repair
- Produces a bright finish with a wide scratch pattern
- Optimum conformability



UPC	Dia. x W x AH	Grade	Max. RPM	Qty./Case
048011-13170-2	6" x 1" x 1"	2S CRS	6,000	3
048011-13171-9	6" x 1" x 1"	2S MED	6,000	3
048011-13172-6	6" x 1" x 1"	2S FIN	6,000	3
048011-13176-4	6" x 2" x 1"	2S CRS	6,000	2
048011-13177-1	6" x 2" x 1"	2S MED	6,000	2
048011-13178-8	6" x 2" x 1"	2S FIN	6,000	2
048011-13183-2	8" x 1" x 3"	2S MED	4,500	3
048011-13184-9	8" x 1" x 3"	2S FIN	4,500	3
048011-13185-6	8" x 2" x 3"	2S CRS	4,500	2
048011-13186-3	8" x 2" x 3"	2S MED	4,500	2

Attention: Wheels are available in other grades and sizes. If you need a specific wheel not listed, contact your 3M Sales Specialist or 3M Authorized Distributor.

Scotch-Brite™ Convolute Wheels

Scotch-Brite™ Cut and Polish Wheels

- For aggressive finishing and blending applications
- Good for defect removal or heavy scratch blending
- Produces a dull finish with a tight scratch pattern
- Harder than other finishing wheels



UPC	Dia. x W x AH	Grade	Max. RPM	Qty./Case
048011-05253-3†	6" x 1/2" x 1"	7A CRS	6,000	4
048011-08931-7†	6" x 1/2" x 1"	7A MED	6,000	4
048011-05182-6	6" x 1/2" x 1"	5A FIN	6,000	4
048011-08946-1†	6" x 1/2" x 1"	7A FIN	6,000	4
048011-03263-4†	6" x 1" x 1"	7A CRS	6,000	3
048011-03262-7†	6" x 1" x 1"	7A MED	6,000	3
048011-02960-3	6" x 1" x 1"	5A FIN	6,000	3
048011-03270-2	6" x 1" x 1"	7A FIN	6,000	3
048011-03269-6†	6" x 1" x 1"	7A VFN	6,000	3
048011-93503-4†	6" x 1" x 1-1/4"	5A FIN	6,000	3
048011-03273-3†	6" x 2" x 1"	7A CRS	6,000	2
048011-03272-6†	6" x 2" x 1"	7A MED	6,000	2
048011-02972-6†	6" x 2" x 1"	5A FIN	6,000	2
048011-60043-7†	6" x 25" x 1"	7A MED	6,000	1
048011-05183-3†	8" x 1/2" x 3"	7A MED	4,500	4
048011-09018-4†	8" x 1/2" x 3"	5A FIN	4,500	4
048011-14623-2†	8" x 1/2" x 3"	7A FIN	4,500	4
048011-02974-0†	8" x 1" x 1-1/4"	5A FIN	4,500	3
048011-03277-1†	8" x 1" x 3"	7A CRS	4,500	3
048011-03276-4	8" x 1" x 3"	7A MED	4,500	3
048011-02965-8†	8" x 1" x 3"	5A FIN	4,500	3
048011-03275-7†	8" x 1" x 3"	7A FIN	4,500	3
048011-03274-0†	8" x 1" x 3"	7A VFN	4,500	3
048011-92862-3†	8" x 1-1/2" x 1-1/4"	5A FIN	4,500	2
048011-08934-8†	8" x 1-1/2" x 3"	7A MED	4,500	2
048011-04156-8†	8" x 1-1/2" x 3"	5A FIN	4,500	2
048011-02976-4†	8" x 2" x 1-1/4"	5A FIN	4,500	2
048011-03282-5†	8" x 2" x 3"	7A CRS	4,500	2
048011-03281-8	8" x 2" x 3"	7A MED	4,500	2
048011-02967-2†	8" x 2" x 3"	5A FIN	4,500	2
048011-03280-1†	8" x 2" x 3"	7A FIN	4,500	2
048011-03279-5†	8" x 2" x 3"	7A VFN	4,500	2
048011-93674-1†	8" x 2-1/2" x 3"	7A MED	4,500	1

† Made-to-Order

Scotch-Brite™ Cut and Polish Wheels (cont.)

UPC	Dia. x W x AH	Grade	Max. RPM	Qty./Case
048011-03283-2†	8" x 3" x 3"	7A MED	4,500	1
048011-02979-5†	8" x 3" x 3"	5A FIN	4,500	1
048011-93454-9†	8" x 4" x 3"	7A CRS	4,500	1
048011-92936-1†	8" x 4" x 3"	7A MED	4,500	1
048011-93675-8†	8" x 5" x 3"	7A MED	4,500	1
048011-05248-9†	8" x 7" x 3"	7A FIN	4,500	1
048011-13488-8†	8" x 20" x 3"	5A FIN	4,500	1
048011-25617-7†	8" x 24" x 3"	7A MED	4,500	1
048011-15591-3†	8" x 24" x 3"	5A FIN	4,500	1
048011-13486-4†	8" x 25" x 3"	7A CRS	4,500	1
048011-92938-5†	8" x 25" x 3"	7A MED	4,500	1
048011-16463-2†	8" x 25" x 3"	5A FIN	4,500	1
048011-60040-6†	8" x 25" x 3"	7A VFN	4,500	1
048011-04244-2†	12" x 1/2" x 5"	7A MED	3,000	2
048011-05256-4†	12" x 1/2" x 5"	5A FIN	3,000	2
048011-03295-5†	12" x 1" x 5"	7A CRS	3,000	1
048011-03294-8†	12" x 1" x 5"	7A MED	3,000	1
048011-02975-7†	12" x 1" x 5"	5A FIN	3,000	1
048011-93677-2†	12" x 1-1/2" x 5"	7A MED	3,000	1
048011-02977-1†	12" x 1-1/2" x 5"	5A FIN	3,000	1
048011-03300-6†	12" x 2" x 5"	7A CRS	3,000	1
048011-03299-3	12" x 2" x 5"	7A MED	3,000	1
048011-02969-6	12" x 2" x 5"	5A FIN	3,000	1
048011-03297-9†	12" x 2" x 5"	7A VFN	3,000	1
048011-03303-7†	12" x 3" x 5"	7A MED	3,000	1
048011-05908-2†	12" x 3" x 5"	5A FIN	3,000	1
048011-03301-3†	12" x 3" x 5"	7A VFN	3,000	1
048011-05533-6†	12" x 4" x 5"	7A MED	3,000	1
048011-02983-2†	12" x 4" x 5"	5A FIN	3,000	1
048011-05243-4†	12" x 4" x 5"	7A VFN	3,000	1
048011-16913-2†	12" x 5" x 5"	5A FIN	3,000	1
048011-27887-2†	12" x 24" x 5"	5A FIN	3,000	1
048011-60042-0†	12" x 25" x 5"	7A CRS	3,000	1
048011-60044-4†	12" x 25" x 5"	7A MED	3,000	1
048011-60041-3†	12" x 25" x 5"	7A VFN	3,000	1

† Made-to-Order

Attention: Wheels are available in other grades and sizes. If you need a specific wheel not listed, contact your 3M Sales Specialist or 3M Authorized Distributor.

Scotch-Brite™ Convolute Wheels

Scotch-Brite™ Light Deburring Wheel

- For finishing applications; can also be used for light deburring
- Produces a bright and consistent finish with tight scratch pattern
- Very soft and conformable



UPC	Dia. x W x AH	Grade	Max. RPM	Qty./Case
048011-03993-0	6" x 1/2" x 1"	6S FIN	6,000	4
048011-01662-7	6" x 1/2" x 1"	7S FIN	6,000	4
048011-03994-7	6" x 1/2" x 1"	8S FIN	6,000	4
048011-01660-3	6" x 1" x 1"	6S FIN	6,000	3
048011-01661-0	6" x 1" x 1"	7S FIN	6,000	3
048011-01675-7	6" x 1" x 1"	8S FIN	6,000	3
048011-01664-1	6" x 2" x 1"	7S FIN	6,000	2
048011-05263-2	8" x 1/2" x 3"	7S FIN	4,500	4
048011-01678-8	8" x 1/2" x 3"	8S FIN	4,500	4

Scotch-Brite™ Light Deburring Wheel (cont.)

UPC	Dia. x W x AH	Grade	Max. RPM	Qty./Case
048011-01665-8	8" x 1" x 3"	6S FIN	4,500	3
048011-01666-5	8" x 1" x 3"	7S FIN	4,500	3
048011-01679-5	8" x 1" x 3"	8S FIN	4,500	3
048011-01667-2	8" x 2" x 3"	7S FIN	4,500	2
048011-01683-2	10" x 1" x 5"	7S FIN	3,600	2
048011-05181-9	12" x 1/2" x 5"	7S FIN	3,000	2
048011-01669-6	12" x 1" x 5"	6S FIN	3,000	1
048011-01670-2	12" x 1" x 5"	7S FIN	3,000	1
048011-01686-3	12" x 1" x 5"	8S FIN	3,000	1
048011-01672-6	12" x 2" x 5"	6S FIN	3,000	1
048011-01673-3	12" x 2" x 5"	7S FIN	3,000	1
048011-01689-4	12" x 2" x 5"	8S FIN	3,000	1
048011-01690-0	12" x 3" x 5"	7S FIN	3,000	1
048011-17985-8	16" x 2" x 10"	7S FIN	2,250	1

Scotch-Brite™ Unitized Wheels

Scotch-Brite™ Unitized Wheels

Get high performance and durability in a variety of cleaning, deburring, finishing and polishing applications. Used on right angle grinders and bench tools, Scotch-Brite™ Wheels produce great results on all types of metal, composites and glass.

Unitized Wheels Selection Guides

Scotch-Brite™ Unitized Wheel performance differences can be attributed to mineral (aggressiveness) and density (hardness). The combination of these two characteristics and subtle variations determine if the wheel will cut more aggressively or will be more durable and less conformable.

Least Aggressive	
↑ ↓	EXL Deburring Wheels (VFN, FIN, MED, CRS, XCS)
	Cut and Polish Wheels (FIN, MED, CRS)
	Roloc EXL Wheels (FIN, MED)
	Rapid Cut Wheels (CRS, XCS)
Most Aggressive	

Softest	
↑ ↓	EXL Deburring Wheels (2, 3, 4, 6, 8)
	Cut and Polish Wheels (5, 7, 9)
	Roloc EXL Wheels (2, 6, 8)
	Rapid Cut Wheels (7, 9)
Hardest	

Mineral Abbreviations (prefix to grade)	
A — Aluminum Oxide mineral	S — Silicon Carbide mineral
C — Ceramic	

Density Number (prefix to mineral)					
soft ← → hard					
2	4	6	7	8	9

Scotch-Brite™ Unitized Wheel	Application			
	Deburring	Blending	Finishing	Polishing
EXL Deburring	•	•	•	•
Cut and Polish	•	•		•
Roloc EXL	•	•		
Rapid Cut	•	•		

Attention: Wheels are available in other grades and sizes. If you need a specific wheel not listed, contact your 3M Sales Specialist or 3M Authorized Distributor.

Scotch-Brite™ Unitized Wheels

Scotch-Brite™ Rapid Cut Unitized Wheels

- Non-woven abrasive wheels utilizing 3M precision shaped ceramic grain for higher levels of cut while maintaining a consistent finish
- Recommended for deburring and weld blending on all metals





UPC	Size	Grade	Max. RPM	Qty./Case
051115-66706-0†	1" x 1/8" x 1/8"	7C CRS+	35,100	100
051115-66732-9†	1" x 1/8" x 1/8"	7C XCS+	35,100	100
051115-66699-5	1" x 1" x 3/16"	7C CRS+	35,100	50
051115-66725-1	1" x 1" x 3/16"	7C XCS+	35,100	50
051115-66718-3†	2" x 1/8" x 1/8"	7C CRS+	22,100	60
051115-66744-2†	2" x 1/8" x 1/8"	7C XCS+	22,100	60
051115-66700-8†	2" x 1/4" x 1/4"	7C CRS+	22,100	60
051115-66726-8†	2" x 1/4" x 1/4"	7C XCS+	22,100	60
051115-66711-4	2" x 1/4" x 1/4"	9C CRS+	22,100	60
051115-66737-4†	2" x 1/4" x 1/4"	9C XCS+	22,100	60
051115-66714-5†	2" x 1/2" x 3/8"	7C CRS+	22,100	30
051115-66740-4†	2" x 1/2" x 3/8"	7C XCS+	22,100	30
051115-66722-0	3" x 1/4" x 3/8"	9C CRS+	18,100	40
051115-66748-0	3" x 1/4" x 3/8"	9C XCS+	18,100	40
051115-66702-2	3" x 1/2" x 3/8"	9C CRS+	18,100	20
051115-66735-0	3" x 1/2" x 3/8"	9C XCS+	18,100	20
051115-66704-6	4" x 1/4" x 5/8"	7C CRS+	12,100	20
051115-66730-5	4" x 1/4" x 5/8"	7C XCS+	12,100	20
051115-66721-3	4" x 1/4" x 5/8"	9C CRS+	12,100	20
051115-66747-3	4" x 1/4" x 5/8"	9C XCS+	12,100	20
048011-64857-6	4" x 1/4" x 7/8"	9C CRS+	12,100	20
048011-64858-3	4" x 1/4" x 7/8"	9C XCS+	12,100	20
051115-66710-7†	6" x 1/8" x 1/2"	7C CRS+	7,500	8
051115-66736-7†	6" x 1/8" x 1/2"	7C XCS+	7,500	8
051115-66701-5†	6" x 1/4" x 1/2"	7C CRS+	7,500	8
051115-66727-5†	6" x 1/4" x 1/2"	7C XCS+	7,500	8
051115-66705-3†	6" x 1/4" x 5/8"	7C CRS+	7,500	8
051115-66731-2†	6" x 1/4" x 5/8"	7C XCS+	7,500	8
048011-64887-3†	6" x 1/4" x 1"	9C XCS+	7,500	8
051115-66713-8†	6" x 1/2" x 1/2"	7C CRS+	7,500	4
051115-66739-8†	6" x 1/2" x 1/2"	7C XCS+	7,500	4
048011-64897-2†	6" x 1/2" x 1/2"	9C XCS+	7,500	4
048011-64908-5†	6" x 1/2" x 1"	9C CRS+	7,500	4
048011-64907-8†	6" x 1/2" x 1"	9C XCS+	7,500	4
051115-66715-2†	6" x 1" x 1"	7C CRS+	7,500	2
051115-66741-1†	6" x 1" x 1"	7C XCS+	7,500	2
051115-66720-6†	8" x 1" x 1"	7C CRS+	5,500	2
051115-66746-6†	8" x 1" x 1"	7C XCS+	5,500	2

Scotch-Brite™ Roloc™ Rapid Cut Unitized Wheels

- Non-woven abrasive wheels utilizing 3M precision shaped ceramic grain for higher levels of cut while maintaining a consistent finish
- Recommended for deburring and weld blending on all metals
- Quick change Roloc™ Attachment



UPC	Size	Grade	Max. RPM	Qty./Case
Roloc TR (Plastic Button) 				
051115-66759-6	2" x NH	9C CRS+	22,100	15/60
048011-64859-0	3" x NH	9C CRS+	15,100	10/40
051115-66760-2	3" x NH	9C XCS+	15,100	10/40
Roloc TS (Plastic Button) 				
051115-66763-3	2" x NH	9C CRS+	22,100	15/60
051115-66764-0†	3" x NH	9C XCS+	15,100	10/40

Scotch-Brite™ Rapid Cut Bench Motor Pack

- #5 telescoping flange adaptor included



UPC	Size	Grade	Qty./Case
048011-64909-2	6" x 1/2" x 1"	9C CRS+	1

Scotch-Brite™ EXL Unitized Deburring Wheels

- Strong and efficient for deburring and polishing of all metal alloys
- Excellent in resisting smearing and minimizing heat buildup on the work piece
- Conformable wheel in a variety of densities and grades for maximum cut and durability



UPC	Dia. x W x AH	Grade	Max. RPM	Qty./Case
048011-15516-6	1" x 1/8" x 1/8"	8A CRS	35,100	100
048011-15517-3	1" x 1/8" x 1/8"	6A MED	35,100	100
048011-13734-6	1" x 1/4" x 1/8"	2S FIN	35,100	100
048011-13752-0	1" x 1" x 3/16"	8A CRS	35,100	50
048011-15527-2	1" x 1" x 3/16"	2A MED	35,100	50
048011-14063-6	1" x 1" x 3/16"	6A MED	35,100	50
048011-13753-7	1" x 1" x 3/16"	8A MED	35,100	50
048011-13713-1	1" x 1" x 3/16"	2S FIN	35,100	50
048011-15514-2	1-1/2" x 1/8" x 3/16"	8A CRS	30,100	80
048011-15515-9	1-1/2" x 1/8" x 3/16"	6A MED	30,100	80
048011-13714-8	1-1/2" x 1/4" x 1/8"	2S FIN	30,100	80
048011-14746-8	1-1/2" x 1/4" x 3/16"	2S FIN	30,100	80

Attention: Wheels are available in other grades and sizes. If you need a specific wheel not listed, contact your 3M Sales Specialist or 3M Authorized Distributor.

Scotch-Brite™ Unitized Wheels

Scotch-Brite™ EXL Unitized Deburring Wheels (cont.)

UPC	Dia. x W x AH	Grade	Max. RPM	Qty./Case
048011-15511-1	2" x 1/8" x 3/16"	8A CRS	22,100	60
048011-15512-8	2" x 1/8" x 3/16"	6A MED	22,100	60
048011-13736-0	2" x 1/4" x 1/8"	2S FIN	16,100	60
048011-15513-5	2" x 1/4" x 3/16"	2S FIN	16,100	60
048011-13755-1	2" x 1/4" x 1/4"	8A CRS	22,100	60
048011-15529-6	2" x 1/4" x 1/4"	2A MED	16,100	60
048011-13932-6	2" x 1/4" x 1/4"	2S FIN	16,100	60
048011-13715-5	2" x 1/2" x 1/4"	2S FIN	16,100	30
048011-15462-6	3" x 1/8" x 1/4"	8A MED	18,100	40
048011-13763-6	3" x 1/4" x 1/4"	8A CRS	18,100	40
048011-15531-9	3" x 1/4" x 1/4"	2A MED	12,100	40
048011-14067-4	3" x 1/4" x 1/4"	6A MED	18,100	40
048011-13764-3	3" x 1/4" x 1/4"	8A MED	18,100	40
048011-13716-2	3" x 1/4" x 1/4"	2S FIN	12,100	40
048011-13766-7	3" x 1/4" x 3/8"	8A CRS	18,100	40
048011-16054-2	3" x 1/4" x 3/8"	2A MED	12,100	40
048011-15118-2	3" x 1/4" x 3/8"	6A MED	18,100	40
048011-14753-6	3" x 1/4" x 3/8"	8A MED	18,100	40
048011-14750-5	3" x 1/4" x 3/8"	2S FIN	12,100	40
048011-14751-2	3" x 1/4" x 3/8"	4A FIN	18,100	40
048011-14752-9	3" x 1/4" x 3/8"	6S FIN	18,100	40
048011-13767-4	3" x 1/2" x 1/4"	8A CRS	15,100	20
048011-15532-6	3" x 1/2" x 1/4"	2A MED	10,000	20
048011-13717-9	3" x 1/2" x 1/4"	2S FIN	10,000	20
048011-13718-6	3" x 3/4" x 1/4"	2S FIN	10,000	10
048011-13739-1	4" x 1/4" x 1/4"	2S FIN	8,500	20
048011-17498-3	6" x 1/4" x 1/2"	2A MED	4,500	8
048011-13741-4	6" x 1/4" x 1/2"	2S FIN	5,000	8
048011-25678-8	6" x 1/4" x 3/4"	2S FIN	5,000	8
048011-15534-0	6" x 1/2" x 1/2"	2A MED	4,500	4
048011-13719-3	6" x 1/2" x 1/2"	2S FIN	5,000	4
048011-15831-0	6" x 1/2" x 5/8"	2S FIN	5,000	4
048011-16545-5	6" x 1/2" x 1"	2A MED	4,500	4
048011-14379-8	6" x 1/2" x 1"	2S FIN	5,000	4
048011-13742-1	6" x 1" x 1/2"	2S FIN	5,000	2
048011-16544-8	6" x 1" x 1"	2A MED	4,500	2
048011-13743-8	6" x 1" x 1"	2S FIN	5,000	2
048011-15827-3	8 x 1/4 x 1/2	2S FIN	4,000	8
048011-15844-0	8" x 1/2" x 1/2"	2S FIN	4,000	4
048011-15824-2	8" x 1/2" x 3/4"	2S FIN	4,000	4
048011-15817-4	12" x 1/2" x 1-1/4"	2S FIN	2,600	2

Scotch-Brite™ Roloc™ EXL Unitized Wheels

- Strong, efficient products for edge deburring and finishing
- Used with 3M™ Roloc™ or 3M™ Roloc™+ holder pads on a straight shaft or right-angle tool



UPC	Size	Grade	Max. RPM	Qty./Case
Roloc TR (Plastic Button)				
048011-17185-2	2"	2A MED	22,100	60
048011-17183-8	2"	2S FIN	22,100	60
048011-17190-6	2"	6A MED	22,100	60
048011-17192-0	2"	8A MED	22,100	60
048011-17186-9	3"	2A MED	15,100	40
048011-17184-5	3"	2S FIN	15,100	40
048011-17191-3	3"	6A MED	15,100	40
048011-17193-7	3"	8A MED	15,100	40

Scotch-Brite™ Cut and Polish Unitized Wheel

- Tightly layered "unitized" construction offers long life and durability
- Excellent for aggressive heavy duty blending and finishing with uniform results
- Good replacement for rubber bonded wheels and small set-up wheels



UPC	Dia. x W x AH	Grade	Max. RPM	Qty./Case
048011-03701-1	1" x 1" x 3/16"	7A CRS	35,100	50
048011-03700-4	1" x 1" x 3/16"	7A MED	35,100	50
048011-01560-6	1" x 1" x 3/16"	5A FIN	35,100	50
048011-08939-3	2" x 1/8" x 1/8"	7A MED	22,100	60
048011-03714-1	2" x 1/8" x 1/4"	7A MED	22,100	60
048011-03716-5	2" x 1/4" x 1/4"	7A CRS	22,100	60
048011-03715-8	2" x 1/4" x 1/4"	7A MED	22,100	60
048011-01561-3	2" x 1/4" x 1/4"	5A FIN	22,100	60
048011-03718-9	2" x 1/2" x 1/4"	7A MED	20,100	30
048011-03727-1	3" x 1/8" x 1/4"	7A MED	18,100	40
048011-03729-5	3" x 1/4" x 1/4"	7A CRS	18,100	40
048011-03728-8	3" x 1/4" x 1/4"	7A MED	18,100	40
048011-01563-7	3" x 1/4" x 1/4"	5A FIN	18,100	40
048011-15121-2	3" x 1/4" x 3/8"	5A FIN	18,100	40
048011-03705-9	3" x 1/2" x 1/4"	7A MED	15,100	20
048011-01565-1	3" x 1/2" x 1/4"	5A FIN	15,100	20
048011-03732-5	3" x 1/2" x 3/8"	7A MED	15,100	20
048011-08878-5	3" x 1/2" x 3/8"	5A FIN	15,100	20
048011-03738-7	3" x 3/4" x 3/8"	7A MED	15,100	10
048011-03740-0	3" x 1" x 1/4"	7A MED	15,100	10
048011-01578-1	4" x 1/4" x 1/4"	5A FIN	12,100	20
048011-01581-1	6" x 1/4" x 1/2"	5A FIN	7,500	8

Attention: Wheels are available in other grades and sizes. If you need a specific wheel not listed, contact your 3M Sales Specialist or 3M Authorized Distributor.

3M™ Flap Wheels

3M™ Flap Wheels

Coated Abrasive flap wheels are the ideal choice for light grinding, blending, graining and scale removal on a variety of metals. The abrasive flaps offer a long lasting supply of fresh abrasives and a load resistant design. Available in both flange mounted and spindle mounted constructions with general purpose aluminum oxide or high performing 3M ceramic aluminum oxide blend abrasive grain.

3M™ Flange Mounted Flap Wheel Selection Guide

Product	Mineral	Grade	Performance	Stainless Steel	Carbon Steel
241E	Aluminum Oxide	50–320	Better		☐
244E	Aluminum Oxide	60–120	Better		☐
741A	Ceramic Aluminum Oxide Blend	50–120	Best	■	■

3M™ Flap Wheels 241E/244E

- Aluminum oxide on a flexible XE wt. cloth backing
- Long life and fast cut
- General purpose flap wheels at a value price

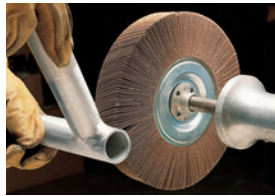

UPC	Dia. x W x AH	Grade	Max. RPM	Qty./Case
Flange Mounted				
051144-35113-8	6" x 1" x 1"	60	6,100	5
051144-35112-1	6" x 1" x 1"	80	6,100	5
051144-35111-4	6" x 1" x 1"	100	6,100	5
051144-35109-1	6" x 1" x 1"	120	6,100	5
051144-35088-9	6" x 2" x 1"	60	5,200	5
051144-35086-5	6" x 2" x 1"	80	5,200	5

Additional sizes are available.

3M™ Flap Wheels 741A

- 3M ceramic aluminum oxide blend abrasive grain on a durable X wt. cloth backing
- Longer life and faster cut

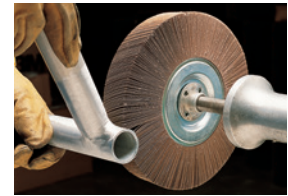

UPC	Dia. x W x AH	Grade	Max. RPM	Qty./Case
Flange Mounted				
051144-82770-1	6" x 1" x 1"	50	6,100	5
051144-81986-7	6" x 1" x 1"	60	6,100	5
051144-81984-3	6" x 1" x 1"	80	6,100	5

Additional sizes are available.

Additional Sizes

3M™ Flap Wheels 241E/244E and 741A can be made-to-order in the following sizes:

Diameter	Arbor Hole
> 3" – 4-1/2"	5/8"
> 4-1/2" – 6"	1"
> 6" – 8"	1" or 1-1/4"
> 8" – 10"	1-3/4" or 2"

Attention: Wheels are available in other grades and sizes. If you need a specific wheel not listed, contact your 3M Sales Specialist or 3M Authorized Distributor.

3M™ Flap Wheels

3M™ Spindle Mounted Flap Wheel Selection Guide

Product	Mineral	Grade	Performance	Stainless Steel	Carbon Steel
244D	Aluminum Oxide	60–120	Better		<input type="checkbox"/>
747D	Ceramic Aluminum Oxide Blend	36–150	Best	<input checked="" type="checkbox"/>	<input checked="" type="checkbox"/>



T83; 1/4" Straight



T84; 1/4–20 Threaded

3M™ Flap Wheels 244D — T83 and T84

- Aluminum oxide
- General purpose flap wheel delivers consistent finish and uniform cut



UPC	Dia. x W x Shk	Grade	Max. RPM	Qty./Case
T83; 1/4" Straight				
051144-35475-7	1" x 1" x 1/4"	60	30,000	10
051144-35476-4	1" x 1" x 1/4"	80	30,000	10
051144-35477-1	1" x 1" x 1/4"	120	30,000	10
051144-14623-9	2" x 1" x 1/4"	60	25,000	10
051144-14624-6	2" x 1" x 1/4"	80	25,000	10
051144-14625-3	2" x 1" x 1/4"	120	25,000	10
051144-14655-0	3" x 1" x 1/4"	60	20,000	10
051144-14656-7	3" x 1" x 1/4"	80	20,000	10
051144-14657-4	3" x 1" x 1/4"	120	20,000	10
T84; 1/4–20 Threaded				
051144-35467-2	1" x 1" x 1/4–20 EXT	60	30,000	10
051144-35468-9	1" x 1" x 1/4–20 EXT	80	30,000	10
051144-35469-6	1" x 1" x 1/4–20 EXT	120	30,000	10
051144-14575-1	2" x 1" x 1/4–20 EXT	60	25,000	10
051144-14576-8	2" x 1" x 1/4–20 EXT	80	25,000	10
051144-14607-9	3" x 1" x 1/4–20 EXT	60	20,000	10
051144-14608-6	3" x 1" x 1/4–20 EXT	80	20,000	10

3M™ Flap Wheels 747D — T83 and T84

- 3M ceramic aluminum oxide blend abrasive grain on a resin-bonded X wt. cloth backing
- Includes a grinding aid for cooler running on stainless steel



UPC	Dia. x W x Shk	Grade	Max. RPM	Qty./Case
T83; 1/4" Straight				
051144-80761-1	1" x 1" x 1/4"	60	30,000	10
051144-80757-4	1" x 1" x 1/4"	80	30,000	10
051144-80753-6	1" x 1" x 1/4"	P120	30,000	10
051144-80763-5	2" x 1" x 1/4"	60	25,000	10
051144-80759-8	2" x 1" x 1/4"	80	25,000	10
051144-80755-0	2" x 1" x 1/4"	P120	25,000	10
051144-80650-8	3" x 1" x 1/4"	60	20,000	10
051144-80651-5	3" x 1" x 1/4"	80	20,000	10
051144-80652-2	3" x 1" x 1/4"	P120	20,000	10
T84; 1/4–20 Threaded				
051144-83271-2	2" x 1" x 1/4–20 EXT	60	25,000	10
051144-83268-2	2" x 1" x 1/4–20 EXT	80	25,000	10
051144-83265-1	2" x 1" x 1/4–20 EXT	P120	25,000	10
051144-83269-9	3" x 1" x 1/4–20 EXT	60	20,000	10
051144-83267-5	3" x 1" x 1/4–20 EXT	80	20,000	10
051144-83263-7	3" x 1" x 1/4–20 EXT	P120	20,000	10

Attention: Wheels are available in other grades and sizes. If you need a specific wheel not listed, contact your 3M Sales Specialist or 3M Authorized Distributor.

3M™ Power Tools for Abrasive Wheel Systems

3M™ Die Grinders — 1 HP

- Powerful 1 HP die grinders are excellent for big jobs such as weld or stock removal
- 3M™ Gripping Material for added comfort and reduced vibration



Model No.	Motor HP (W)	Max RPM	Weight Pound (kg)	Length Inch (mm)	Air Inlet Thread	Collet Size	Airflow Rate SCFM (LPM)	UPC
20237	1 (744)	20,000	1.69 (.77)	7.75 (196.9)	1/4" NPT	1/4"	37 (1,048)	051141-20237-2
20238	1 (744)	18,000	1.69 (.77)	7.75 (196.9)	1/4" NPT	1/4"	37 (1,048)	051141-20238-9
20239	1 (744)	12,000	2.06 (.93)	10 (254)	1/4" NPT	1/4"	37 (1,048)	051141-20239-6
20240	1 (744)	8,000	2.06 (.93)	10 (254)	1/4" NPT	1/4"	37 (1,048)	051141-20240-2

3M™ Die Grinders — 0.5 HP

- Ideal for a variety of polishing, buffing, shaping and deburring applications
- 3M™ Gripping Material for added comfort and reduced vibration
- Available in extended shaft models



Model No.	Motor HP (W)	Max RPM	Weight Pound (kg)	Length Inch (mm)	Air Inlet Thread	Collet Size	Airflow Rate SCFM (LPM)	UPC
28330	0.5 (372)	18,000	1.13 (.512)	6.88 (174.6)	1/4" NPT	1/4"	26 (736)	051141-28330-2
28331	0.5 (372)	18,000*	1.54 (.697)	10.63 (269.9)	1/4" NPT	1/4"	26 (736)	051141-28331-9
28332	0.5 (372)	4,000	1.58 (.717)	8.88 (200)	1/4" NPT	1/4"	26 (736)	051141-28332-6

*With extension

3M™ Die Grinders — 0.3 HP

- Ideal for deburring, blending, finishing and polishing intricate and hard-to-reach areas
- 3M™ Gripping Material for added comfort and reduced vibration
- Available in extended shaft models



Model No.	Motor HP (W)	Max RPM	Weight Pound (kg)	Length Inch (mm)	Air Inlet Thread	Collet Size	Airflow Rate SCFM (LPM)	UPC
28630	0.3 (224)	25,000	1.40 (.639)	10 (254)	1/4" NPT	1/4" [†]	17 (481)	051141-28630-3
28629	0.3 (224)	25,000	0.89 (.405)	6.125 (156)	1/4" NPT	1/4" [†]	17 (481)	051141-28629-7
28628	0.3 (224)	18,000	1.52 (.690)	10 (254)	1/4" NPT	1/4" [†]	17 (481)	051141-28628-0
28627	0.3 (224)	18,000	1.15 (.522)	7.25 (184)	1/4" NPT	1/4" [†]	17 (481)	051141-28627-3

[†]Includes 1/8" collet insert





Accessories for Abrasive Wheel Systems

Product Name	UPC	Qty./Case	For Use With	Size/Description	Max RPM
Mandrel No. 990					
	048011-04018-9	5	Scotch-Brite™ Unitized Wheels with 3/16" Center Hole	2-1/16" x 1/4" x 3/4"	22,200
Mandrel No. 936					
	048011-15012-3	5	Scotch-Brite™ Unitized Wheels with 3/8" Center Hole	3" wheel; 1-3/4" x 1/4" x 1"	18,200
Flange Adapter Kit No. 5					
	048011-16859-3	1 Set	6" Wheels; Telescoping wheel adapters 1" and 1/2" wide to reduce 1" wheel cores to fit 1/2", 5/8", 3/4", or 7/8" shafts; Must be used with side flanges	1" x 1/2" x 1/2"	N/A
	048011-16860-9	1 Set		1" x 1" x 1/2"	N/A
Flange Nut					
	051141-28739-3	1 Set	4" x 1/4" x 5/8" CH Unitized Wheels and Depressed Center Grinding Wheels	1" x 5/8" x 3/8"; 3/8-24 INT	N/A
	051141-28740-9	1 Set		1" x 7/8"; 5/8-11 INT	N/A
Wheel Adapter Kit No. 3					
	051144-45035-0	1	Two arbor hole (plug type) adapters for 6" and 8" diameter flap wheels	1" OD x 1/2" ID	N/A
	051144-45034-3	1		1" OD x 5/8" ID	N/A
	051144-45033-6	1		1" OD x 3/4" ID	N/A
	051144-45032-9	1		1" OD x 7/8" ID	N/A
Wheel Adapter Kit No. 81A					
	051144-45081-7	1	For T84 Flap Wheels	1/4" x 1/4-20 INT	N/A

Large Diameter Wheel Flanges and Other Accessories

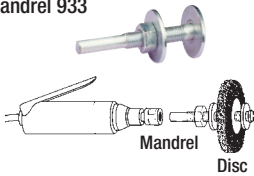
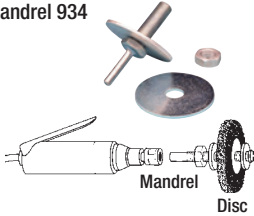
are available and may be purchased directly through Contract Production Services/CPS. Please contact Contract Production Services/CPS directly to check availability and other specific information. Use the part number to identify and specify the desired item.

Accessories for Abrasive Wheel Systems

Product Name	UPC	Qty./Case	For Use With	Size/Description	Max RPM
Mandrel 933  <p>Mandrel Disc</p>	048011-13968-5	5	Furnished complete with washers to fit available wheel sizes; Fits 1/4" x 5/16" center holes	1/4" Shaft Diameter; 2" x 1/4" x 1"	14,000
Mandrel 934  <p>Mandrel Disc</p>	048011-04021-9	1	Furnished complete with washers to fit available wheel sizes; Fits 1/2" center holes	1/2" Shaft Diameter; 3-1/16" x 1/4" x 2-1/2"	12,000
3M™ Wheel Adapter Kit 28419 	051141-28419-4	1	3M™ Inline Sanders; Wheels with 1/2"-1" center holes	1/2-20 EXT x 5/8-11 INT	See MOS of wheel
3M™ Wheel Adapter Kit 45038 	051144-45038-1	1	3M™ Inline Sanders; Wheels with 5/8"-1" center holes	5/8-11 EXT x 5/8-11 INT	See MOS of wheel
3M™ Spindle Extender Kit 	048011-04019-6	1	3M™ Inline Sanders; Wheels with 5/8"-1" center holes	Part No. 300	See MOS of wheel

Inline Sanding Systems



Inline Sanding Systems

Level Welds Quickly to Match Directional Mill Finishes

In three easy steps, using the 3M Finishing System, you can grind and blend welds to match your finish.

		Product Name	
Step 1 Leveling the Weld 		3M™ Fibre Disc 785C	
			3M™ Fibre Disc 501C
Step 2 Setting the Grain 		Premium 3M™ Cubitron™ II Belt 947A	
			3M™ Belt 777F
Step 3 Final Finishing 		Scotch-Brite™ Surface Conditioning Belt A MED for a #4 finish, A CRS for a #3 finish	
			Scotch-Brite™ Match and Finish Flap Brush HS A CRS, A MED
Final Blending and Touch-up Applications 		Scotch-Brite™ Hand Pad 7446 S MED	

Belts and Brushes

**3M™ Cubitron™ II
Abrasive Belt 947A**



- Made with revolutionary 3M precision shaped abrasive grain technology
- Flexible X wt. poly-cotton backing
- Optimized for low-medium pressure applications on stainless, mild steel and aluminum

UPC	W x L	Grade	Min./Case
051125-94733-6	3-1/2" x 15-1/2"	60+	10/50
051125-94734-3	3-1/2" x 15-1/2"	80+	10/50
051125-94735-0	3-1/2" x 15-1/2"	120+	10/50

**3M™ Cloth Belt 777F
for Inline Sanders**



- A premium abrasive belt for use with in-line drum sanders
- 3M™ Ceramic Aluminum Oxide blend abrasive grain for long lasting performance
- Grinding aid for cooler cutting action

UPC No.	Size	Grade	Qty./Case
051144-77476-0	3-1/2" x 15-1/2"	60	50
051144-77333-6	3-1/2" x 15-1/2"	80	50
051144-84307-7	3-1/2" x 15-1/2"	P120	50

**Scotch-Brite™ Surface Conditioning
Belt for Inline Sanders**



- Match and blend final finishes
- Run at low speeds to generate uniform, well-blended satin finishes
- 1 HP

UPC No.	Size	Grade	Color	Qty./Case
048011-09650-6	3" x 10-11/16"	A VFN	Blue	10
048011-05016-4	3-1/2" x 15-1/2"	A CRS	Brown	10
048011-05228-1	3-1/2" x 15-1/2"	A MED	Maroon	10
048011-05643-2	3-1/2" x 15-1/2"	A VFN	Blue	10

**Scotch-Brite™ Match and Finish
Flap Brushes and Combi Flap Brushes**



- Match final finishes back into fabricated metals like stainless steel, aluminum, brass and others
- Conforms to most surface geometrics
- Easy to control
- Easy-thread on/off attachment
- MOS: 3,500 RPM

UPC	D x W x CH	Grade	Color	Qty./Case
Flap Brushes				
051141-55748-9	4-1/2" x 4" x 5/8-11	5A XCS	Black	2
051141-55749-6	4-1/2" x 4" x 5/8-11	HS 7A CRS	Gold	2
051141-55750-2	4-1/2" x 4" x 5/8-11	HS 7A MED	Purple	2
051141-55745-8	4-1/2" x 4" x 5/8-11	5A MED	Maroon	2
051141-55747-2	4-1/2" x 4" x 5/8-11	5S MED	Gray	2
051141-55746-5	4-1/2" x 4" x 5/8-11	5A VFIN	Maroon	2
051141-55730-4	4-1/2" x 2" x 5/8-11*	5A XCS	Black	2
051141-55731-1	4-1/2" x 2" x 5/8-11*	HS 7A CRS	Gold	2
051141-55732-8	4-1/2" x 2" x 5/8-11*	HS 7A MED	Purple	2
051141-55727-4	4-1/2" x 2" x 5/8-11*	5A MED	Maroon	2
051141-55729-8	4-1/2" x 2" x 5/8-11*	5S MED	Gray	2
051141-55728-1	4-1/2" x 2" x 5/8-11*	5A VFIN	Maroon	2
Combi Flap Brushes				
051141-55744-1	4-1/2" x 4" x 5/8-11	A 60	Maroon	2
051141-55742-7	4-1/2" x 4" x 5/8-11	A 100	Maroon	2
051141-55743-4	4-1/2" x 4" x 5/8-11	A 150	Maroon	2
051141-55726-7	4-1/2" x 2" x 5/8-11*	A 60	Maroon	2
051141-55724-3	4-1/2" x 2" x 5/8-11*	A 100	Maroon	2
051141-55725-0	4-1/2" x 2" x 5/8-11*	A 150	Maroon	2

*Also available in 4-way keyway attachments.

3M™ Inline Sanders

- Generate straight-line scratches for finishing stainless steel and other metals
- Can be used with inflatable or slotted wheel accessories and many other wheel products



Model No.	Motor HP (W)	Max RPM	Weight Pound (kg)	Length Inch (mm)	Air Inlet Thread	Airflow Rate SCFM (LPM)	Shaft Size	UPC
28338	1 (744)	1,600	3.32 (1.51)	9.88 (251)	1/4" NPT	37 (1,048)	5/8"-11 EXT	051141-28338-8
28339	1 (744)	3,500	2.64 (1.20)	8.50 (216)	1/4" NPT	37 (1,048)	5/8"-11 EXT	051141-28339-5

3M™ Match and Finish Sander

- Generate straight-line scratches for finishing stainless steel and other metals
- Front to back motion helps prevent curved scratches
- Easy to control for reduced start/stop marks
- Easy screw-on/screw-off attachments
- Design for use with Scotch-Brite™ Match and Finish Flap Brushes, 3M™ Abrasive Belts or Scotch-Brite™ Belts*



Model No.	Motor HP (W)	Max RPM	Weight Pound (kg)	Length Inch (mm)	Air Inlet Thread	Airflow Rate SCFM (LPM)	Shaft Size	UPC
28659	1 (744)	3,500	4.6 (2.1)	13.5 (343)	1/4" NPT	37 (1,048)	5/8"-11 EXT	051141-28659-4

*To run belt products, 3M™ Expander Wheel (28718) and Adapter Kit (28719) are required. See page 68.

Accessories for Inline Sanding Systems

Product Name	UPC	Qty./Case	For Use With	Size/Description	Max RPM
3M™ Rubber Slotted Expander Wheels	Use 3M™ Wheel Adapter Kits to mount wheel to inline sander				
	051141-28348-7	1	For use with belts 3-1/2" x 15-1/2" or 3" x 10-11/16"	5" x 3-1/2" 5/8" Arbor Hole	3,500
	051141-28349-4	1		3-1/4" x 3" 5/8" Arbor Hole	3,500
3M™ Wheel Adapter Kit 45038					
	051144-45038-1	1	3M™ Inline Sanders; Wheels with 5/8"–1" center holes	5/8–11 EXT x 5/8–11 INT	See MOS of wheel
3M™ Spindle Extender Kit					
	048011-04019-6	1	3M™ Inline Sanders; Wheels with 5/8"–1" center holes	Part No. 300	See MOS of wheel
3M™ Match and Finish Rubber Slotted Expander Wheel	Use 3M™ Expander Wheel and Adapter Kit with 3M™ Match and Finish Sander NEW!				
	051141-28718-8	1	3-1/2" x 15-1/2" belts	5" x 3-1/2" x 1" AH	3,500
	051141-27819-5	1	To mount 28718 wheel on 3M™ Match and Finish Sander	1" x 5/8–11 INT	N/A

Hand Finishing



3M™ Abrasive Sheets

3M™ Abrasive Sheets

3M™ Utility Cloth Sheet and Roll Selection Guide

A good choice for all your utility sanding and general maintenance work. Can be torn and rolled without shelling.

Product ID	Mineral	Backing	Features	Performance	Blending	Finishing	Cleaning
011K	Aluminum Oxide	Flexible Utility Cloth	Closed Coat; General purpose use	Good	■	■	■
211K	Aluminum Oxide	Flexible Utility Cloth	Use for all general maintenance work	Better		□	
314D	Premium Aluminum Oxide	Durable Cloth	Strong bonding system for shelling resistance	Best	■	■	■

3M™ Wetordry™ Sheet Selection Guide

Still a favorite for their reduced clogging, long life and great finish. Good general use sheet for hand or machine sanding. Can be run wet or dry.

Product ID	Mineral	Backing	Blending	Finishing
431Q	Silicon Carbide	C wt. Paper	■	
413Q	Silicon Carbide	A wt. Paper		■

3M™ Paper Sheet Selection Guide

Conformable and versatile, 3M™ Paper Sheets are ideal for hand or machine sanding. Various constructions available for use on wood, metal, paint, plastic and fiberglass.

Product ID	Mineral	Backing	Performance	Blending	Finishing
336U	Aluminum Oxide	C wt. Paper	Better	□	
346U	Aluminum Oxide	D wt. Paper	Best	■	

3M™ Utility Cloth Sheets 011K

- Aluminum Oxide mineral
- General purpose use



UPC	W x L	Grade	Min./Case
Sheets			
051144-02433-9	9" x 11"	CRS	50/250
051144-02432-2	9" x 11"	MED	50/250
051144-02431-5	9" x 11"	FINE	50/250

3M™ Utility Cloth Sheets and Rolls 211K

- Aluminum oxide on a J wt. cloth backing
- Use these flexible utility rolls and sheets for general applications such as deburring, rust removal, strapping and all general maintenance work



UPC	W x L	Grade	Min./Case
Sheets			
051144-02410-0	9" x 11"	80	50/250
051144-02409-4	9" x 11"	100	50/250
051144-02408-7	9" x 11"	120	50/250

3M™ Abrasive Sheets

3M™ Utility Cloth Sheets and Rolls 211K (cont.)

UPC	W x L	Grade	Min./Case
Sheets			
051144-02407-0	9" x 11"	150	50/250
051144-02406-3	9" x 11"	180	50/250
051144-02405-6	9" x 11"	220	50/250
051144-02404-9	9" x 11"	240	50/250
051144-02402-5	9" x 11"	320	50/250
051144-12501-2	9" x 11"	400	50/250
051144-12500-5	9" x 11"	500	50/250
Utility Rolls			
051144-05010-9	1" x 50 yds.	80	1/5
051144-05009-3	1" x 50 yds.	100	1/5
051144-05008-6	1" x 50 yds.	120	1/5
051144-05007-9	1" x 50 yds.	150	1/5
051144-05006-2	1" x 50 yds.	180	1/5
051144-05005-5	1" x 50 yds.	220	1/5
051144-05004-8	1" x 50 yds.	240	1/5
051144-05003-1	1" x 50 yds.	280	1/5
051144-05002-4	1" x 50 yds.	320	1/5
051144-05001-7	1" x 50 yds.	400	1/5
051144-05000-0	1" x 50 yds.	500	1/5
051144-05030-7	1-1/2" x 50 yds.	80	1/5
051144-05029-1	1-1/2" x 50 yds.	100	1/5
051144-05028-4	1-1/2" x 50 yds.	120	1/5
051144-05027-7	1-1/2" x 50 yds.	150	1/5
051144-05026-0	1-1/2" x 50 yds.	180	1/5
051144-05025-3	1-1/2" x 50 yds.	220	1/5
051144-05024-6	1-1/2" x 50 yds.	240	1/5
051144-05022-2	1-1/2" x 50 yds.	320	1/5
051144-05021-5	1-1/2" x 50 yds.	400	1/5
051144-05020-8	1-1/2" x 50 yds.	500	1/5
051144-05050-5	2" x 50 yds.	80	1/5
051144-05049-9	2" x 50 yds.	100	1/5
051144-05048-2	2" x 50 yds.	120	1/5
051144-05047-5	2" x 50 yds.	150	1/5
051144-05046-8	2" x 50 yds.	180	1/5
051144-05045-1	2" x 50 yds.	220	1/5
051144-05044-4	2" x 50 yds.	240	1/5
051144-05042-0	2" x 50 yds.	320	1/5
051144-05041-3	2" x 50 yds.	400	1/5
051144-05040-6	2" x 50 yds.	500	1/5

3M™ Utility Cloth Sheets and Rolls 314D

- Aluminum oxide on X and J wt. cloth backings
- Ideal for all utility jobs
- Can be torn into strips and rolled without shelling



UPC	W x L	Grade	Backing	Min./Case
Sheets				
051115-19775-8	9" x 11"	P40	X wt.	50/250
051115-19774-1	9" x 11"	P50	X wt.	50/250
051115-19773-4	9" x 11"	P60	X wt.	50/250
051115-19772-7	9" x 11"	P80	J wt.	50/250
051115-19771-0	9" x 11"	P100	J wt.	50/250
051115-19770-3	9" x 11"	P120	J wt.	50/250
051115-19769-7	9" x 11"	P150	J wt.	50/250
051115-19768-0	9" x 11"	P180	J wt.	50/250
051115-19767-3	9" x 11"	P220	J wt.	50/250
051115-19766-6	9" x 11"	P240	J wt.	50/250
051115-19765-9	9" x 11"	P280	J wt.	50/250
051115-19764-2	9" x 11"	P320	J wt.	50/250
051115-19763-5	9" x 11"	P400	J wt.	50/250
Utility Rolls				
051115-19794-9	1" x 50 yds.	P50	X wt.	1/5
051115-19793-2	1" x 50 yds.	P60	X wt.	1/5
051115-19792-5	1" x 50 yds.	P80	J wt.	1/5
051115-19791-8	1" x 50 yds.	P100	J wt.	1/5
051115-19790-1	1" x 50 yds.	P120	J wt.	1/5
051115-19789-5	1" x 50 yds.	P150	J wt.	1/5
051115-19788-8	1" x 50 yds.	P180	J wt.	1/5
051115-19787-1	1" x 50 yds.	P220	J wt.	1/5
051115-19786-4	1" x 50 yds.	P240	J wt.	1/5
051115-19785-7	1" x 50 yds.	P280	J wt.	1/5
051115-19784-0	1" x 50 yds.	P320	J wt.	1/5
051115-19783-3	1" x 50 yds.	P400	J wt.	1/5
051115-19813-7	1-1/2" x 50 yds.	P50	X wt.	1/5
051115-19812-0	1-1/2" x 50 yds.	P60	X wt.	1/5
051115-19811-3	1-1/2" x 50 yds.	P80	J wt.	1/5
051115-19810-6	1-1/2" x 50 yds.	P100	J wt.	1/5
051115-19809-0	1-1/2" x 50 yds.	P120	J wt.	1/5
051115-19808-3	1-1/2" x 50 yds.	P150	J wt.	1/5
051115-19807-6	1-1/2" x 50 yds.	P180	J wt.	1/5
051115-19806-9	1-1/2" x 50 yds.	P220	J wt.	1/5
051115-19805-2	1-1/2" x 50 yds.	P240	J wt.	1/5
051115-19804-5	1-1/2" x 50 yds.	P280	J wt.	1/5
051115-19803-8	1-1/2" x 50 yds.	P320	J wt.	1/5
051115-19802-1	1-1/2" x 50 yds.	P400	J wt.	1/5

3M™ Abrasive Sheets

3M™ Utility Cloth Sheets and Rolls 314D (cont.)

UPC	W x L	Grade	Backing	Min./Case
Utility Rolls				
051115-19826-7	2" x 50 yds.	P40	X wt.	1/5
051115-19825-0	2" x 50 yds.	P50	X wt.	1/5
051115-19824-3	2" x 50 yds.	P60	X wt.	1/5
051115-19823-6	2" x 50 yds.	P80	J wt.	1/5
051115-19822-9	2" x 50 yds.	P100	J wt.	1/5
051115-19821-2	2" x 50 yds.	P120	J wt.	1/5
051115-19820-5	2" x 50 yds.	P150	J wt.	1/5
051115-19819-9	2" x 50 yds.	P180	J wt.	1/5
051115-19818-2	2" x 50 yds.	P220	J wt.	1/5
051115-19817-5	2" x 50 yds.	P240	J wt.	1/5
051115-19816-8	2" x 50 yds.	P280	J wt.	1/5
051115-19815-1	2" x 50 yds.	P320	J wt.	1/5
051115-19814-4	2" x 50 yds.	P400	J wt.	1/5

3M™ Wetordry™ Sheets 413Q

- Silicon carbide on an A wt. paper backing
- Reduced clogging eliminates dust when used wet
- Excellent conformability



UPC	W x L	Grade	Min./Case
051144-02007-2	9" x 11"	220	50/500
051144-02006-5	9" x 11"	240	50/250
051144-02005-8	9" x 11"	280	50/250
051144-02004-1	9" x 11"	320	50/500
051144-02003-4	9" x 11"	360	50/250
051144-02002-7	9" x 11"	400	50/500

3M™ Wetordry™ Paper Sheets 431Q

- Silicon carbide on a C wt. paper backing
- Reduced clogging eliminates dust when used wet
- Heavyweight paper backing for increased durability



UPC	W x L	Grade	Min./Case
051144-02018-8	9" x 11"	80	50/250
051144-02017-1	9" x 11"	100	50/250
051144-02016-4	9" x 11"	120	50/250
051144-02015-7	9" x 11"	150	50/250
051144-02014-0	9" x 11"	180	50/250

3M™ Paper Sheets 336U/346U

- Aluminum oxide on D wt. (grades 36–80) and C wt. (grades 100–150) paper backing
- Open coat resists loading on soft materials
- General purpose sheets ideal for hand or machine sanding of many different materials, including wood, metals, paints, plastics and fiberglass



UPC	W x L	Grade	Min./Case
336U			
051144-02114-7	9" x 11"	100	100/1000
051144-02113-0	9" x 11"	120	100/1000
051144-02112-3	9" x 11"	150	100/1000
346U			
051144-02119-2	9" x 11"	36	50/250
051144-02118-5	9" x 11"	40	50/250
051144-02117-8	9" x 11"	50	50/500
051144-02116-1	9" x 11"	60	50/500
051144-02115-4	9" x 11"	80	50/500

Scotch-Brite™ Hand Pads

Scotch-Brite™ Hand Pads

Scotch-Brite™ Hand Pads give you a fast, consistent scuff for everyday surface preparation. Ideal for cleaning parts and scuffing prior to staining and painting. Also a great alternative to steel wool — similar performance without the rusting or splintering.

Scotch-Brite™ Hand Pad Selection Guide

Performance	Blending	Deburring	Finishing	Cleaning
Better	7446, 7447	7440, 7447, 7448	—	—
Best	7440, 8447	7446, 8447	7440	7447
Premium	7447/7448 PRO	7447/7448 PRO	7447/7448 PRO	8447

Less Aggressive/Finer Finish

More Aggressive/Coarser Finish

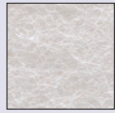

7445

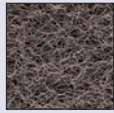

7448

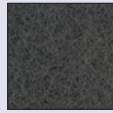

7448 PRO

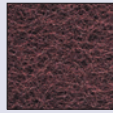

7447

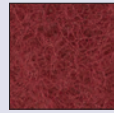

7447 PRO



8447

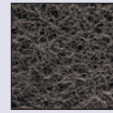

7446



7440

Scotch-Brite™ Light Duty Cleansing Pad 7445

- Very mild abrasive for gentle, yet thorough cleaning
- Commonly used with liquid detergent
- Performance similar to steel wool grade 0000



UPC	W x L	Grade	Color	Qty./Case
048011-16976-7	6" x 9"	F SFN	White	60

Scotch-Brite™ Ultra Fine Hand Pad 7448

- Ultra fine consistent finishes on metals, woods, plastics and composites
- Performance similar to steel wool grade 00



UPC	W x L	Grade	Color	Qty./Case
048011-04028-8	6" x 9"	S ULF	Gray	60

Scotch-Brite™ Hand Pads 7448 PRO

- High performance pad takes less time to prep surface and lasts longer
- Tightly graded abrasive particles for consistent, uniform scratch throughout life of the hand pad
- New, long lasting pad made with durable non-woven nylon web is flexible enough to get into hard-to-sand places; Specially coated to minimize loading
- Ideal for everyday uses like prepping surfaces for color coat; general scuffing, cleaning and hand blending
- Center perforated for convenience

NEW!



UPC	W x L	Grade	Color	Qty./Case
048011-64935-1	6" x 9"	S ULF	Gray	20
048011-64933-7	Trial Pack — Includes one each: 7447 PRO and 7448 PRO			

Scotch-Brite™ General Purpose Hand Pad 7447

- Worldwide standard for surface conditioning
- Clean, blend, finish and deburr faster, easier, and with better results than conventional abrasives
- Performance similar to steel wool grade 1

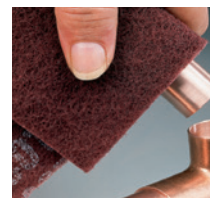

UPC	W x L	Grade	Color	Qty./Case
048011-04029-5	6" x 9"	A VFN	Maroon	60

Scotch-Brite™ Hand Pads 7447 PRO

NEW!

- High performance pad takes less time to prep surface and lasts longer
- Tightly graded abrasive particles for consistent, uniform scratch throughout life of the hand pad
- New, long lasting pad made with durable non-woven nylon web is flexible enough to get into hard-to-sand places; Specially coated to minimize loading
- Ideal for everyday uses like prepping surfaces for color coat; general scuffing, cleaning and hand blending
- Center perforated for convenience

UPC	W x L	Grade	Color	Qty./Case
048011-64926-9	6" x 9"	A VFN	Maroon	20
048011-64933-7	Trial Pack — Includes one each: 7447 PRO and 7448 PRO			

Scotch-Brite™ Durable Flex Hand Pads

NEW!

- High performance pads are packed with tightly graded abrasive mineral for more consistent, fast cut
- Flexible pad cleans, blends and finishes where conformability is needed
- Ideal for prepping surfaces for primer and color coat, general scuffing, cleaning and hand blending
- S Ultra Fine (S ULF) produces a finish similar to steel wool grade 00
- A Very Fine (A VFN) produces a finish similar to steel wool grade 1

UPC	W x L	Grade	Color	Qty./Case
048011-64659-6	4-1/2" x 9"	A VFN	Maroon	100
048011-64660-2	4-1/2" x 9"	S ULF	Gray	100

Scotch-Brite™ Production Hand Pad 8447



- High cut for paint prep, blending and scuffing
- Long life performance on aluminum, stainless steel, plastics, wood and fiberglass
- Performance similar to steel wool grade 2

UPC	W x L	Grade	Color	Qty./Case
048011-24037-4	6" x 9"	A VFN	Maroon	60

Scotch-Brite™ Blending Hand Pad 7446



- Specially designed for hand blending and finishing stainless steel
- Mineral coarseness blends surface scratches on many metals, wood and synthetic surfaces
- Performance similar to steel wool grade 3

UPC	W x L	Grade	Color	Qty./Case
048011-04051-6	6" x 9"	S MED	Gray	40

Scotch-Brite™ Heavy Duty Hand Pad 7440



- Most durable and aggressive pad for quick stock removal
- Cuts fast to remove contaminants and oxides in demanding cleaning and finishing applications
- Performance similar to steel wool grade 4

UPC	W x L	Grade	Color	Qty./Case
048011-04050-9	6" x 9"	A MED	Gray	40

Scotch-Brite™ Multi-Flex Sheet Rolls



- Highly conformable non-woven web roll is perforated to easily tear into sixty 8" x 4" sheets
- Excellent sharpness and conformability for cleaning and finishing surfaces by hand

UPC	W x L	Grade	Color	Qty./Case
051131-07521-4	8" x 20'	A VFN	Maroon	2
051131-07522-1	8" x 20'	S ULF	Light Gray	2

Scotch-Brite™ Hand Pad Trial Packs

Scotch-Brite™ Hand Pad Trial Pack 7447 PRO and 7448 PRO

NEW!



- Contains 1 each of the following:
 - Scotch-Brite™ Hand Pad 7447 PRO (Maroon)
 - Scotch-Brite™ Hand Pad 7448 PRO (Gray)

UPC	Size	Min./Case
048011-64933-7	6" x 9"	20 packs/case

Scotch-Brite™ Hand Pad Trial Pack 961S



- Contains 1 each of the following:
 - Scrubbing Sponge 74
 - Light Duty Pad 6448
 - Heavy Duty Pad 7440
 - Light Duty Cleansing Pad 7445
 - Blending Pad 7446
 - General Purpose Pad 7447
 - Ultra Fine Pad 7448
 - Production Pad 8447
 - Twist-Lok™ Pad Holder 961

UPC	Size	Min./Case
048011-17144-9	6" x 9"	5

Less Aggressive/Finer Finish

More Aggressive/Coarser Finish

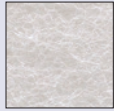

7445

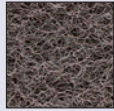

7448

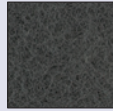

7448 PRO

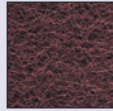

7447

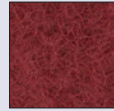

7447 PRO



8447

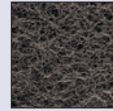

7446



7440

Scotch-Brite™ Roll Selection Guide

Performance	Blending	Finishing	Deburring	Cleaning
Good	Multi-Flex	Multi-Flex	—	—
Better	Clean and Finish	Clean and Finish	—	Multi-Flex
Best	Cut and Polish	Production Clean and Finish	—	Clean and Finish
Premium	7447/7448 PRO	7447/7448 PRO	Cut and Polish	Production Clean and Finish

Scotch-Brite™ Clear Blend Prep Scuff 7745

- Ideal for top coat rubbing, sealer sanding prior to lacquer, and defuzzing or denibbing wood
- Performance similar to steel wool grade 000



UPC	W x L	Grade	Color	Qty./Case
051131-07745-4	4-3/4" x 15'	A ULF	Gold	3

Scotch-Brite™ Cut and Polish Rolls

- A unique and aggressive material for cleaning and finishing
- Sturdy, long lasting web material is great for heavy industrial cleaning and light deburring applications
- Works well for stropping and other bench applications



UPC	W x L	Grade	Qty./Case
048011-04085-1	1" x 30'	A MED	2
048011-05206-9	2" x 30'	A MED	2
048011-05207-6	4" x 30'	A MED	2

Scotch-Brite™ Production Clean and Finish Rolls

- Precision web/mineral configuration for most uniform general purpose finishing in roll form
- Excellent for critical finishes and long life



UPC	W x L	Grade	Color	Qty./Case
048011-28175-9†	4" x 30'	A VFN	Maroon	3
048011-28176-6†	6" x 30'	A VFN	Maroon	2

† Made-to-Order

Scotch-Brite™ Clean and Finish Rolls

- Highly conformable non-woven web can be cut to desired length for hand sanding or oscillating sanders



UPC	W x L	Grade	Qty./Case
048011-00291-0†	2" x 30'	A FIN	6
048011-00260-6	2" x 30'	A VFN	6
048011-00261-3	3" x 30'	A VFN	4
048011-00264-4	4" x 30'	A MED	3
048011-00265-1	4" x 30'	A FIN	3
048011-00266-8	4" x 30'	A VFN	3
048011-00270-5	4" x 30'	A VFN	3
048011-00263-7	4" x 30'	F SFN	3
048011-00267-5	4" x 30'	F SFN	3
048011-00268-2	4" x 30'	S ULF	3
048011-00262-0	4" x 30'	TALC	3
048011-00274-3	6" x 30'	A MED	2
048011-00275-0	6" x 30'	A FIN	2
048011-00276-7	6" x 30'	A VFN	2
048011-00284-2	12" x 30'	A VFN	1
048011-00254-5	12" x 30'	TALC	1

† Made-to-Order

Scotch-Brite™ 7447/7448 PRO Rolls



- High performance abrasive takes less time to prep surface and lasts longer
- Tightly graded abrasive particles for consistent, uniform scratch throughout life of the abrasive
- New, long lasting pad made with durable non-woven nylon web is flexible enough to get into hard-to-sand places; Specially coated to minimize loading
- Ideal for everyday uses like prepping surfaces for color coat; general scuffing, cleaning and hand blending



UPC	W x L	Grade	Color	Qty./Case
048011-64964-1†	Belt sizes made to order. Specify UPC, grade and belt size (W" x L").	S ULF	Gray	Determined by belt size.
048011-64956-6†		A VFN	Maroon	

† Made-to-Order

Accessories for Hand Finishing

Product Name	UPC	Qty./Case	For Use With	Size/Description	Max RPM
Forked Spindle 	051144-45121-0	10	For attaching utility cloth strips	1/4" x 3"	N/A
3M™ Wetordry™ Sponge Pad	051131-05526-1	50	Wetordry™ Paper Sheets	2-3/4" x 5-1/2" x 3/8"	N/A
3M™ Stikit™ Soft Hand Pad	051144-05530-2	5/10	Stikit™ Sheet Rolls	2-3/4" x 5-1/2" x 3/8"	N/A
Scotch-Brite™ Pad Holder No. 961 	048011-09493-4	10	Scotch-Brite™ Hand Pads; Provides increased leverage and eliminates "finger" marks	3-1/2" x 4-3/4"	N/A
Mini Mandrel No. 935 	048011-04020-2	5	Scotch-Brite™ Strips to clean and polish inner diameters and other tight areas	2-7/8" x 1/4"	14,000

Specialty Abrasives



3M™ Cartridge Rolls

3M™ Cartridge Rolls

Cartridge rolls are ideal for getting into small, hard to reach spaces. As they wear, the wrapped layers of the cartridge roll continuously expose fresh abrasive layers for continued cutting action. Available in regular and tapered construction.

3M™ Cartridge Rolls 341D

- Aluminum oxide on an X wt. cloth backing
- Long life and fast cut
- General purpose cartridge rolls at a value price



UPC	Dia. x L x CH	Grade	Max. RPM	Qty./Case
Regular				
051144-96959-3	1/4" x 1" x 1/8"	P60	24,000	100
051144-14021-3	1/4" x 1" x 1/8"	P80	24,000	100
051144-96961-6	1/4" x 1" x 1/8"	P120	24,000	100
051144-96963-0	1/4" x 1" x 1/8"	P180	24,000	100
051144-96968-5	1/4" x 1-1/2" x 1/8"	P60	24,000	100
051144-96969-2	1/4" x 1-1/2" x 1/8"	P80	24,000	100
051144-96971-5	1/4" x 1-1/2" x 1/8"	P120	24,000	100
051144-96973-9	1/4" x 1-1/2" x 1/8"	P180	24,000	100
051144-14024-4	3/8" x 1" x 1/8"	P60	24,000	100
051144-14023-7	3/8" x 1" x 1/8"	P80	24,000	100
051144-14022-0	3/8" x 1" x 1/8"	P120	24,000	100
051144-97008-7	3/8" x 1" x 1/8"	P180	24,000	100
051144-97013-1	3/8" x 1-1/2" x 1/8"	P60	24,000	100
051144-20417-8	3/8" x 1-1/2" x 1/8"	P80	24,000	100
051144-97015-5	3/8" x 1-1/2" x 1/8"	P120	24,000	100
051144-97017-9	3/8" x 1-1/2" x 1/8"	P180	24,000	100
051144-97041-4	1/2" x 1" x 1/8"	P60	24,000	100
051144-97042-1	1/2" x 1" x 1/8"	P80	24,000	100
051144-97044-5	1/2" x 1" x 1/8"	P120	24,000	100
051144-14028-2	1/2" x 1-1/2" x 1/8"	P60	24,000	100
051144-14027-5	1/2" x 1-1/2" x 1/8"	P80	24,000	100
051144-14026-8	1/2" x 1-1/2" x 1/8"	P120	24,000	100
051144-97059-9	1/2" x 1-1/2" x 1/8"	P180	24,000	100
051144-97162-6	3/4" x 1-1/2" x 3/16"	P60	16,000	100
051144-97163-3	3/4" x 1-1/2" x 3/16"	P80	16,000	100
051144-97165-7	3/4" x 1-1/2" x 3/16"	P120	16,000	100

3M™ Cartridge Rolls 341D (cont.)

UPC	Dia. x L x CH	Grade	Max. RPM	Qty./Case
Full Taper				
051144-97239-5	3/8" x 1" x 1/8"	P60	24,000	100
051144-97240-1	3/8" x 1" x 1/8"	P80	24,000	100
051144-97242-5	3/8" x 1" x 1/8"	P120	24,000	100
051144-97244-9	3/8" x 1" x 1/8"	P180	24,000	100
051144-97248-7	3/8" x 1-1/2" x 1/8"	P60	24,000	100
051144-97249-4	3/8" x 1-1/2" x 1/8"	P80	24,000	100
051144-97251-7	3/8" x 1-1/2" x 1/8"	P120	24,000	100
051144-97257-9	1/2" x 1" x 1/8"	P60	24,000	100
051144-97259-3	1/2" x 1" x 1/8"	P120	24,000	100
051144-14034-3	1/2" x 1-1/2" x 1/8"	P60	24,000	100
051144-14033-6	1/2" x 1-1/2" x 1/8"	P80	24,000	100
051144-14032-9	1/2" x 1-1/2" x 1/8"	P120	24,000	100
051144-97267-8	1/2" x 1-1/2" x 1/8"	P180	24,000	100

3M™ Cartridge Rolls 747D

- 3M ceramic aluminum oxide blend abrasive grain on an X wt. cloth backing
- Long life and fast cut
- Contains grinding aid for cooler cutting on heat sensitive alloys

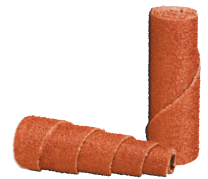

UPC	Dia. x L x CH	Grade	Max. RPM	Qty./Case
Regular				
051144-80790-1	1/2" x 1-1/2" x 1/8"	60	24,000	100
051144-80796-3	1/2" x 1-1/2" x 1/8"	80	24,000	100
051144-80792-5	1/2" x 1-1/2" x 1/8"	P120	24,000	100
Full Taper				
051144-80786-4	1/2" x 1-1/2" x 1/8"	60	24,000	100
051144-80787-1	1/2" x 1-1/2" x 1/8"	80	24,000	100
051144-80788-8	1/2" x 1-1/2" x 1/8"	P120	24,000	100

3M™ Square and Cross Pads

3M™ Square and Cross Pads

Square pads are ideal for fast grinding/blending of channels, fillets, corners and spotting on flat surfaces. As the square pads rotate, the corners exert a fast biting action and gradually wear down to expose fresh abrasive material. Cross pads are used for close tolerance polishing of small radii and channels, deburring the ends and insides of tubing and other special applications.

3M™ Square Pads 341D

- Premium aluminum oxide on an X wt. cloth backing
- Long life and fast cut
- General purpose pads at a value price



UPC	Size	Grade	Max RPM	Min./Case
1/4–20 Eyelet				
051141-27353-2†	2" x 2" x 3/8"	60	12,000	50/100
051141-27354-9†	2" x 2" x 3/8"	80	12,000	50/100
051141-27355-6†	2" x 2" x 3/8"	P120	12,000	50/100
051141-27350-1	2" x 2" x 1/2"	60	12,000	50/100
051141-27351-8	2" x 2" x 1/2"	80	12,000	50/100
051141-27352-5	2" x 2" x 1/2"	P120	12,000	50/100
051144-97723-9	3" x 3" x 1/4"	P120	9,000	50/100
051141-27356-3†	3" x 3" x 1/2"	60	9,000	50/100
051141-27357-0†	3" x 3" x 1/2"	80	9,000	50/100
051141-27358-7†	3" x 3" x 1/2"	P120	9,000	50/100

† Made-to-Order

3M™ Square Pads 747D

- 3M ceramic aluminum oxide blend abrasive grain on an X wt. cloth backing
- Super aggressive cut rate and durability
- Contains grinding aid for cooler cutting on heat sensitive alloys



UPC	Size	Grade	Max RPM	Qty./Case
1/4–20 Eyelet				
051141-27359-4†	2" x 2" x 1/2"	60	12,000	100
051141-27360-0†	2" x 2" x 1/2"	80	12,000	100
051141-27361-7†	2" x 2" x 1/2"	P120	12,000	100
051141-27362-4†	2" x 2" x 3/8"	60	12,000	100
051141-27363-1†	2" x 2" x 3/8"	80	12,000	100
051141-27364-8†	2" x 2" x 3/8"	P120	12,000	100
051141-27365-5†	3" x 3" x 1/2"	60	9,000	100
051141-27366-2†	3" x 3" x 1/2"	80	9,000	100
051141-27367-9†	3" x 3" x 1/2"	P120	9,000	100

† Made-to-Order

3M™ Cross Pads 341D

- Premium aluminum oxide on an X wt. cloth backing
- Long life and fast cut
- General purpose pads at a value price



UPC	Size	Grade	Max RPM	Min./Case
8 or 10 Ply; 8–32 Eyelet				
051141-27368-6	1" x 1" x 3/8"	60	24,000	50/100
051141-27369-3	1" x 1" x 3/8"	80	24,000	50/100
051141-27370-9†	1" x 1" x 3/8"	P120	24,000	50/100
051141-27371-6	1-1/2" x 1-1/2" x 1/2"	60	24,000	50/100
051141-27372-3	1-1/2" x 1-1/2" x 1/2"	80	24,000	50/100
051141-27373-0	1-1/2" x 1-1/2" x 1/2"	P120	24,000	50/100

10 Ply; 8–32 Eyelet				
051141-27374-7	2" x 2" x 1/2"	60	18,000	50/100
051141-27375-4	2" x 2" x 1/2"	80	18,000	50/100
051141-27376-1	2" x 2" x 1/2"	P120	18,000	50/100
051141-27377-8	2" x 2" x 3/4"	60	18,000	50/100
051141-27378-5	2" x 2" x 3/4"	80	18,000	50/100
051141-27379-2	2" x 2" x 3/4"	P120	18,000	50/100
051144-97750-5	2-1/2" x 2-1/2" x 3/4"	60	18,000	50/100

8 or 10 Ply; 1/4–20 Eyelet				
051141-27380-8	3" x 3" x 1"	60	18,000	50/100
051141-27381-5	3" x 3" x 1"	80	18,000	50/100
051141-27382-2†	3" x 3" x 1"	P120	18,000	50/100
051144-97760-4	3" x 3" x 1-1/2"	60	18,000	50/100
051144-97766-6	3-1/2" x 3-1/2" x 1-1/2"	80	15,000	50/100
051144-97768-0	4" x 4" x 1"	60	12,000	50/100
051144-98880-2	5" x 5" x 1-1/2"	60	10,000	50/100
051144-97783-3	6" x 6" x 1-1/2"	60	9,000	50/100

† Made-to-Order

3M™ Cross Pads 747D

- 3M ceramic aluminum oxide blend abrasive grain on an X wt. cloth backing
- Super aggressive cut rate and durability
- Contains grinding aid for cooler cutting on heat sensitive alloys

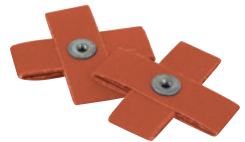

UPC	Size	Grade	Max RPM	Qty./Case
8 Ply; 1/4–20 Eyelet				
051141-20368-3	1-1/2" x 1-1/2" x 1/2"	60	24,000	100
051141-20369-0	1-1/2" x 1-1/2" x 1/2"	80	24,000	100
051141-20372-0	1-1/2" x 1-1/2" x 1/2"	P100	24,000	100
051141-20379-9	1-1/2" x 1-1/2" x 1/2"	P120	24,000	100
051141-20380-5	2" x 2" x 1/2"	60	18,000	100
051141-20367-6	2" x 2" x 1/2"	P100	18,000	100
051141-20375-1	2" x 2" x 3/4"	80	18,000	100

3M™ Bands

Great for getting at those hard to reach places and contours. Ideal for removing parting lines, imperfections and burrs. Use with 3M™ Die Grinders and 3M™ Rubber Slotted Expander Wheel or 3M™ Rubber Cushion Polishing Wheel.

3M™ Bands 341D

- Aluminum oxide on an X wt. cloth backing
- Fast cut and long life
- General purpose evenrun bands at a value price



UPC	Dia. x W	Grade	Max. RPM	Qty./Case
051144-40243-4	1/4" x 1/2"	P80	23,000	100
051144-97428-3	1/4" x 1/2"	P120	23,000	100
051144-27446-7	1/2" x 1/2"	P36	30,000	100
051144-40228-1	1/2" x 1/2"	P60	30,000	100
051144-40227-4	1/2" x 1/2"	P80	30,000	100
051144-40252-6	1/2" x 1/2"	P120	30,000	100
051144-97458-0	1/2" x 1"	P36	15,000	100
051144-40225-0	1/2" x 1"	P60	15,000	100
051144-40224-3	1/2" x 1"	P80	15,000	100
051144-11973-8	1/2" x 1"	P120	15,000	100
051144-11976-9	3/4" x 1"	P36	17,000	100
051144-40221-2	3/4" x 1"	P60	17,000	100
051144-40220-5	3/4" x 1"	P80	17,000	100
051144-40219-9	3/4" x 1"	P120	17,000	100
051144-11977-6	3/4" x 1-1/2"	P36	10,000	100
051144-40241-0	3/4" x 1-1/2"	P80	10,000	100
051144-40214-4	1" x 1"	P36	18,000	100
051144-40211-3	1" x 1"	P60	18,000	100
051144-40210-6	1" x 1"	P80	18,000	100
051144-40208-3	1" x 1"	P120	18,000	100
051144-40207-6	1" x 1-1/2"	P36	10,000	100
051144-11980-6	1" x 1-1/2"	P60	10,000	100
051144-40205-2	1" x 1-1/2"	P80	10,000	100
051144-40203-8	1-1/2" x 1"	P36	14,000	100
051144-40202-1	1-1/2" x 1"	P60	14,000	100
051144-40200-7	1-1/2" x 1-1/2"	P36	10,000	100
051144-40197-0	1-1/2" x 1-1/2"	P60	10,000	100
051144-40196-3	1-1/2" x 1-1/2"	P80	10,000	100
051144-40274-8	1-1/2" x 1-1/2"	P120	10,000	100
051144-40267-0	1-1/2" x 2"	P60	8,000	100
051144-40192-5	2" x 1"	P60	11,000	100
051144-40187-1	2" x 2"	P36	6,000	100
051144-40184-0	2" x 2"	P60	6,000	100
051144-40183-3	2" x 2"	P80	6,000	100
051144-40178-9	3" x 3"	P36	3,000	50
051144-40175-8	3" x 3"	P60	3,000	50
051144-40174-1	3" x 3"	P80	3,000	50
051144-40172-7	3" x 3"	P120	3,000	50

3M™ Bands 747D

- 3M ceramic aluminum oxide blend abrasive grain on an X wt. cloth backing
- Long life and fast cut
- Contains grinding aid for cooler cutting on heat sensitive alloys



UPC	Dia. x W	Grade	Max. RPM	Qty./Case
051144-80765-9	1/2" x 1"	50	15,000	100
051144-80769-7	1/2" x 1"	60	15,000	100
051144-80773-4	1/2" x 1"	80	15,000	100
051144-80766-6	1" x 1"	50	18,000	100
051144-80770-3	1" x 1"	60	18,000	100
051144-80774-1	1" x 1"	80	18,000	100
051144-80782-6	1" x 1"	P120	18,000	100
051144-80771-0	2" x 1"	60	11,000	100
051144-80775-8	2" x 1"	80	11,000	100
051144-80783-3	2" x 1"	P120	11,000	100

Scotch-Brite™ Specialty Abrasives

Scotch-Brite™ Specialty Abrasives

Make tough jobs easy with these Scotch-Brite™ specialty abrasives. Unique constructions for use on contours and flat areas — on metal, wood, paint, coatings and more.

Scotch-Brite™ EXL Unitized Mounted Points

- EXL unitized material dressed to six different ANSI shapes for delicate deburring and finishing of critical parts

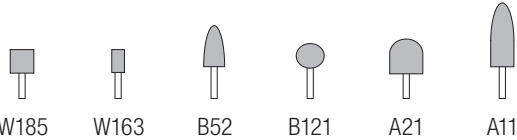

UPC No.	Size	Shape	Density	Grade	Qty./Case
1/4" Shank					
048011-64794-4	7/8" x 2" x 1/4"	A11	8	A MED	50
048011-64795-1	7/8" x 2" x 1/4"	A11	8	S FIN	50
048011-64796-8	1" x 1" x 1/4"	A21	8	A MED	50
048011-64797-5	1" x 1" x 1/4"	A21	8	S FIN	50
1/8" Shank					
048011-64798-2	1/2" x 1/2" x 1/8"	B121	8	A MED	50
048011-64799-9	1/2" x 1/2" x 1/8"	B121	8	A CRS	50
048011-64800-2	3/8" x 3/4" x 1/8"	B52	8	A CRS	50
048011-64801-9	3/8" x 3/4" x 1/8"	B52	8	A MED	50
048011-64802-6	3/8" x 3/4" x 1/8"	B52	8	S FIN	50
048011-64803-3	1/4" x 1/2" x 1/8"	W163	8	A CRS	50
048011-64804-0	1/4" x 1/2" x 1/8"	W163	8	S FIN	50
048011-64805-7	1/4" x 1/2" x 1/8"	W163	8	A MED	50
048011-64806-4	1/2" x 1/2" x 1/8"	W185	8	A CRS	50
048011-64807-1	1/2" x 1/2" x 1/8"	W185	8	A MED	50
048011-64808-8	1/2" x 1/2" x 1/8"	W185	8	S FIN	50

Scotch-Brite™ Radial Bristle Brush, TA

- Excellent replacement for wire brushes
- Use on bench motors for general purpose cleaning applications
- No flying wires yet higher cut rates
- Very strong and flexible
- Comes with adapters for multiple shaft sizes (1/2", 5/8", 3/4", 7/8", 1", 2" and 8")



UPC	Dia. x W	Grade	Color	Max. RPM	Qty./Case
048011-24279-8	3" x 3/8"	50	Green	25,000	40
048011-24280-4	3" x 3/8"	80	Yellow	25,000	40
048011-24281-1	3" x 3/8"	120	White	25,000	40
048011-27603-8	6" x 1/2" x 1"	36	Brown	6,000	5
048011-27605-2	6" x 1/2" x 1"	50	Green	6,000	5
048011-27606-9	6" x 1/2" x 1"	80	Yellow	6,000	5

Scotch-Brite™ Flap Brush CPFB-S and CPFB-R+

- Heavy-duty brush
- Excellent for removing handling marks and surface imperfections
- Available on 1/4" shaft (CPFB-S) or 3M™ Roloc™+ attachment system (CPFB-R+)



UPC	Dia. x W x Shaft	Grade	Max. RPM	Qty./Case
CPFB-S				
048011-16622-3	2" x 1" x 1/4"	A MED	12,000	25
048011-05974-7	3" x 1-3/4" x 1/4"	A MED	8,500	10
CPFB-R+				
048011-14588-4	3" x 1-3/8"	A MED	8,000	10

Scotch-Brite™ Flap Brush CFFB-S and CFFB-R

- Ideal for decorative finishes and light deburring applications
- Available on 1/4" shaft (CFFB-S) or 3M™ Roloc™+ attachment system (CFFB-R)



UPC	Dia. x W x Shaft	Grade	Max. RPM	Qty./Case
CFFB-S				
048011-05975-4	3" x 1-3/4" x 1/4"	A CRS	8,500	10
048011-14781-9	3" x 1-3/4" x 1/4"	S FIN	8,500	10
CFFB-R				
048011-14587-7	3" x 1-3/8"	A CRS	8,000	10
048011-14783-3	3" x 1-3/8"	S FIN	8,000	10

Scotch-Brite™ Combi Wheel, Combi-S

- Made of alternating flaps of coated abrasive and Scotch-Brite™ web
- Provides aggressive cut and fine finishes



UPC	Dia. x W x Shaft	Grade	Max. RPM	Qty./Case
CFFB-S				
051144-80801-4	3" x 1-3/4" x 1/4"	80	8,000	10
051144-80678-2	3" x 1-3/4" x 1/4"	P120	8,000	10
051144-80799-4	3" x 1-3/4" x 1/4"	P180	8,000	10

Scotch-Brite™ Specialty Abrasives

Scotch-Brite™ CPD5-R and CPD5-S Discs

- Five discs made of a durable web, ganged together on a shaft
- Use for satin or antique finishing as well as light- to medium-duty cleaning applications
- Available on a 1/4" shaft (CPD5-S) or 3M™ Roloc™+ attachment system (CPD5-R)



UPC	Dia. x W x (Shaft)	Grade	Max. RPM	Qty./Case
CPD5-S				
048011-14593-8	3" x 1-1/4" x 1/4"	A MED	10,000	10
048011-14779-6	4" x 1-1/4" x 1/4"	A MED	8,000	10
CPD5-R				
048011-14594-5	3" x 1-1/4"	A MED	10,000	10
048011-14590-7	4" x 1-1/4"	A MED	8,000	10

Scotch-Brite™ Clean and Strip Discs D2

- Aggressive web is excellent for cleaning welds, rust, paint and coatings



UPC	Dia. x W x Shaft	Grade	Max. RPM	Qty./Case
048011-14780-2	4" x 1" x 1/4"	S XCS	8,000	10
048011-14784-0	4" x 1"	S XCS	8,000	8

Scotch-Brite™ Stars

- Perfect for polishing internal diameters of pipe and tubing
- Conformable Scotch-Brite™ construction assures complete cleaning and polishing of all surfaces



UPC	Diameter	Grade	Max. RPM	Qty./Case
048011-13370-6	1-1/2"	A CRS	24,000	100
048011-13800-8	1-1/2"	A VFN	24,000	100
048011-13371-3	2"	A CRS	24,000	100
048011-13803-9	2"	A VFN	24,000	100
048011-13372-0	3"	A CRS	18,000	50
048011-13802-2	3"	A VFN	18,000	50
048011-13373-7	4"	A CRS	18,000	50
048011-13804-6	4"	A VFN	18,000	50

Scotch-Brite™ Cross Buffs

- Versatile and flexible shape ideal for light deburring, cleaning, finishing and polishing internal diameters and hard to reach areas
- Available in A VFN for high luster finishes or A MED for more aggressive applications requiring increased durability



UPC	Diameter	Grade	Max. RPM	Qty./Case
048011-64299-4	1" x 3/8" x 2 PLY x 8-32	A MED	20,000	50
048011-64446-2	1" x 3/8" x 2 PLY x 8-32	A VFN	20,000	50
048011-64305-2	1-1/2" x 3/8" x 2 PLY x 8-32	A MED	20,000	50
048011-64526-1	1-1/2" x 3/8" x 2 PLY x 8-32	A VFN	20,000	50
048011-64447-9	1-1/2" x 1/2" x 2 PLY x 8-32	A VFN	20,000	100
048011-64312-0	2" x 1/2" x 2 PLY x 8-32	A MED	12,000	25
048011-64433-2	2" x 1/2" x 2 PLY x 8-32	A VFN	12,000	25

Scotch-Brite™ Unitized Wheel Pack 990S

- Contains several Scotch-Brite™ external Unitized Wheels 1" x 1" x 3/16" and 3" x 1/4" x 3/8" in a variety of densities and grades
- Also includes 936 and 990 mandrels



UPC	Size	Min./Case
048011-18245-2	1" x 1" x 3/16" and 3" x 1/4" x 3/8"	1/5



3M™ Power Tools for Specialty Abrasives

3M™ Die Grinders — 1 HP

- Powerful 1 HP die grinders are excellent for big jobs such as weld or stock removal
- 3M™ Gripping Material for added comfort and reduced vibration



Model No.	Motor HP (W)	Max RPM	Weight Pound (kg)	Length Inch (mm)	Air Inlet Thread	Collet Size	Airflow Rate SCFM (LPM)	UPC
20237	1 (744)	20,000	1.69 (.77)	7.75 (196.9)	1/4" NPT	1/4"	37 (1,048)	051141-20237-2
20238	1 (744)	18,000	1.69 (.77)	7.75 (196.9)	1/4" NPT	1/4"	37 (1,048)	051141-20238-9
NEW! 28770	1 (744)	18,000	2.60 (1.2)	13 (318)	1/4" NPT	1/4"	37 (1,084)	051141-28770-6
20239	1 (744)	12,000	2.06 (.93)	10 (254)	1/4" NPT	1/4"	37 (1,048)	051141-20239-6
20240	1 (744)	8,000	2.06 (.93)	10 (254)	1/4" NPT	1/4"	37 (1,048)	051141-20240-2

3M™ Die Grinders — 0.5 HP

- Ideal for a variety of polishing, buffing, shaping and deburring applications
- 3M™ Gripping Material for added comfort and reduced vibration
- Available in extended shaft models



Model No.	Motor HP (W)	Max RPM	Weight Pound (kg)	Length Inch (mm)	Air Inlet Thread	Collet Size	Airflow Rate SCFM (LPM)	UPC
28330	0.5 (372)	18,000	1.13 (.512)	6.88 (174.6)	1/4" NPT	1/4"	26 (736)	051141-28330-2
28331	0.5 (372)	18,000*	1.54 (.697)	10.63 (269.9)	1/4" NPT	1/4"	26 (736)	051141-28331-9
28332	0.5 (372)	4,000	1.58 (.717)	8.88 (200)	1/4" NPT	1/4"	26 (736)	051141-28332-6

*With extension

3M™ Die Grinders — 0.3 HP

- Ideal for deburring, blending, finishing and polishing intricate and hard-to-reach areas
- 3M™ Gripping Material for added comfort and reduced vibration
- Available in extended shaft models



Model No.	Motor HP (W)	Max RPM	Weight Pound (kg)	Length Inch (mm)	Air Inlet Thread	Collet Size	Airflow Rate SCFM (LPM)	UPC
28630	0.3 (224)	25,000	1.40 (.639)	10 (254)	1/4" NPT	1/4"†	17 (481)	051141-28630-3
28629	0.3 (224)	25,000	0.89 (.405)	6.125 (156)	1/4" NPT	1/4"†	17 (481)	051141-28629-7
28628	0.3 (224)	18,000	1.52 (.690)	10 (254)	1/4" NPT	1/4"†	17 (481)	051141-28628-0
28627	0.3 (224)	18,000	1.15 (.522)	7.25 (184)	1/4" NPT	1/4"†	17 (481)	051141-28627-3

†Includes 1/8" collet insert

3M™ Match and Finish Sander







- Generate straight-line scratches for finishing stainless steel and other metals
- Front to back motion helps prevent curved scratches
- Easy to control for reduced start/stop marks
- Easy screw-on/screw-off attachments
- Design for use with Scotch-Brite™ Match and Finish Flap Brushes, 3M™ Abrasive Belts or Scotch-Brite™ Belts*







Model No.	Motor HP (W)	Max RPM	Weight Pound (kg)	Length Inch (mm)	Air Inlet Thread	Airflow Rate SCFM (LPM)	Shaft Size	UPC
28659	1 (744)	3,500	4.6 (2.1)	13.5 (343)	1/4" NPT	37 (1,048)	5/8"-11 EXT	051141-28659-4

*To run belt products, 3M™ Expander Wheel (28718) and Adapter Kit (28719) are required. See page 68.

Accessories for Specialty Abrasives

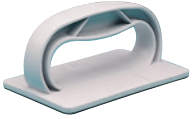
Product Name	UPC	Qty./Case	For Use With	Size/Description	Max RPM
Mandrel No. 944 	048011-13928-9	1	Scotch-Brite™ Stars for cleaning and polishing internal diameters of pipe and tubing	1/4" x 1/4-20 EXT	25,100
3M™ Mandrel 	048011-14307-8	1	Scotch-Brite™ Cross Buffs for cleaning and polishing internal diameters of pipe and tubing	1/4" x 8-32 EXT	Dependent upon abrasive product used
3M™ Mandrels 	051144-45119-7	25	Screw-type mandrels for securing cartridge rolls to tool	1/8" x 1" x 1/4"	24,000 (1/2" and smaller cartridge roll diameter); 16,000 (5/8" - 3/4" cartridge roll diameter)
	051144-45117-3	25	Screw-type mandrels for securing cartridge rolls to tool	3/16" x 1" x 1/4"	
	051144-45118-0	25	Screw-type mandrels for securing cartridge rolls to tool	3/16" x 1-1/2" x 1/4"	
3M™ Square and Cross Pad Mandrel 	051144-14308-5	1		1/4" x 1/4-20 EXT	Dependent upon abrasive product used
	051144-14307-8	1	Used for holding square and cross pads with 1/4-20 and 8-32 internal threaded inserts	1/4" x 8-32 EXT	
	051141-28385-2	5		1/4" x 3-48 EXT	
Forked Spindle 	051144-45121-0	10	For attaching utility cloth strips	1/4" x 3"	N/A
3M™ Wetordry™ Sponge Pad 	051131-05526-1	50	Wetordry™ Paper Sheets	2-3/4" x 5-1/2" x 3/8"	N/A
3M™ Stikit™ Soft Hand Pad 	051144-05530-2	5/10	Stikit™ Sheet Rolls	2-3/4" x 5-1/2" x 3/8"	N/A

Accessories for Specialty Abrasives

Product Name	UPC	Qty./Case	For Use With	Size/Description	Max RPM
 <p>Scotch-Brite™ Pad Holder No. 961</p>	048011-09493-4	10	Scotch-Brite™ Hand Pads; Provides increased leverage and eliminates “finger” marks	3-1/2" x 4-3/4"	N/A
 <p>Mini Mandrel No. 935</p>	048011-04020-2	5	Scotch-Brite™ Strips to clean and polish inner diameters and other tight areas	2-7/8" x 1/4"	14,000
 <p>3M™ Match and Finish Rubber Slotted Expander Wheel</p>	Use 3M™ Expander Wheel and Adapter Kit with 3M™ Match and Finish Sander NEW!				
 <p>NEW!</p>	051141-28718-8	1	3-1/2" x 15-1/2" belts	5" x 3-1/2" x 1" AH	3,500
 <p>NEW!</p>	051141-27819-5	1	To mount 28718 wheel on 3M™ Match and Finish Sander	1" x 5/8–11 INT	N/A

Specialty Abrasives



3M™ Cartridge Rolls

3M™ Cartridge Rolls

Cartridge rolls are ideal for getting into small, hard to reach spaces. As they wear, the wrapped layers of the cartridge roll continuously expose fresh abrasive layers for continued cutting action. Available in regular and tapered construction.

3M™ Cartridge Rolls 341D

- Aluminum oxide on an X wt. cloth backing
- Long life and fast cut
- General purpose cartridge rolls at a value price



UPC	Dia. x L x CH	Grade	Max. RPM	Qty./Case
Regular				
051144-96959-3	1/4" x 1" x 1/8"	P60	24,000	100
051144-14021-3	1/4" x 1" x 1/8"	P80	24,000	100
051144-96961-6	1/4" x 1" x 1/8"	P120	24,000	100
051144-96963-0	1/4" x 1" x 1/8"	P180	24,000	100
051144-96968-5	1/4" x 1-1/2" x 1/8"	P60	24,000	100
051144-96969-2	1/4" x 1-1/2" x 1/8"	P80	24,000	100
051144-96971-5	1/4" x 1-1/2" x 1/8"	P120	24,000	100
051144-96973-9	1/4" x 1-1/2" x 1/8"	P180	24,000	100
051144-14024-4	3/8" x 1" x 1/8"	P60	24,000	100
051144-14023-7	3/8" x 1" x 1/8"	P80	24,000	100
051144-14022-0	3/8" x 1" x 1/8"	P120	24,000	100
051144-97008-7	3/8" x 1" x 1/8"	P180	24,000	100
051144-97013-1	3/8" x 1-1/2" x 1/8"	P60	24,000	100
051144-20417-8	3/8" x 1-1/2" x 1/8"	P80	24,000	100
051144-97015-5	3/8" x 1-1/2" x 1/8"	P120	24,000	100
051144-97017-9	3/8" x 1-1/2" x 1/8"	P180	24,000	100
051144-97041-4	1/2" x 1" x 1/8"	P60	24,000	100
051144-97042-1	1/2" x 1" x 1/8"	P80	24,000	100
051144-97044-5	1/2" x 1" x 1/8"	P120	24,000	100
051144-14028-2	1/2" x 1-1/2" x 1/8"	P60	24,000	100
051144-14027-5	1/2" x 1-1/2" x 1/8"	P80	24,000	100
051144-14026-8	1/2" x 1-1/2" x 1/8"	P120	24,000	100
051144-97059-9	1/2" x 1-1/2" x 1/8"	P180	24,000	100
051144-97162-6	3/4" x 1-1/2" x 3/16"	P60	16,000	100
051144-97163-3	3/4" x 1-1/2" x 3/16"	P80	16,000	100
051144-97165-7	3/4" x 1-1/2" x 3/16"	P120	16,000	100

3M™ Cartridge Rolls 341D (cont.)

UPC	Dia. x L x CH	Grade	Max. RPM	Qty./Case
Full Taper				
051144-97239-5	3/8" x 1" x 1/8"	P60	24,000	100
051144-97240-1	3/8" x 1" x 1/8"	P80	24,000	100
051144-97242-5	3/8" x 1" x 1/8"	P120	24,000	100
051144-97244-9	3/8" x 1" x 1/8"	P180	24,000	100
051144-97248-7	3/8" x 1-1/2" x 1/8"	P60	24,000	100
051144-97249-4	3/8" x 1-1/2" x 1/8"	P80	24,000	100
051144-97251-7	3/8" x 1-1/2" x 1/8"	P120	24,000	100
051144-97257-9	1/2" x 1" x 1/8"	P60	24,000	100
051144-97259-3	1/2" x 1" x 1/8"	P120	24,000	100
051144-14034-3	1/2" x 1-1/2" x 1/8"	P60	24,000	100
051144-14033-6	1/2" x 1-1/2" x 1/8"	P80	24,000	100
051144-14032-9	1/2" x 1-1/2" x 1/8"	P120	24,000	100
051144-97267-8	1/2" x 1-1/2" x 1/8"	P180	24,000	100

3M™ Cartridge Rolls 747D

- 3M ceramic aluminum oxide blend abrasive grain on an X wt. cloth backing
- Long life and fast cut
- Contains grinding aid for cooler cutting on heat sensitive alloys



UPC	Dia. x L x CH	Grade	Max. RPM	Qty./Case
Regular				
051144-80790-1	1/2" x 1-1/2" x 1/8"	60	24,000	100
051144-80796-3	1/2" x 1-1/2" x 1/8"	80	24,000	100
051144-80792-5	1/2" x 1-1/2" x 1/8"	P120	24,000	100
Full Taper				
051144-80786-4	1/2" x 1-1/2" x 1/8"	60	24,000	100
051144-80787-1	1/2" x 1-1/2" x 1/8"	80	24,000	100
051144-80788-8	1/2" x 1-1/2" x 1/8"	P120	24,000	100

3M™ Square and Cross Pads

3M™ Square and Cross Pads

Square pads are ideal for fast grinding/blending of channels, fillets, corners and spotting on flat surfaces. As the square pads rotate, the corners exert a fast biting action and gradually wear down to expose fresh abrasive material. Cross pads are used for close tolerance polishing of small radii and channels, deburring the ends and insides of tubing and other special applications.

3M™ Square Pads 341D

- Premium aluminum oxide on an X wt. cloth backing
- Long life and fast cut
- General purpose pads at a value price



UPC	Size	Grade	Max RPM	Min./Case
1/4–20 Eyelet				
051141-27353-2†	2" x 2" x 3/8"	60	12,000	50/100
051141-27354-9†	2" x 2" x 3/8"	80	12,000	50/100
051141-27355-6†	2" x 2" x 3/8"	P120	12,000	50/100
051141-27350-1	2" x 2" x 1/2"	60	12,000	50/100
051141-27351-8	2" x 2" x 1/2"	80	12,000	50/100
051141-27352-5	2" x 2" x 1/2"	P120	12,000	50/100
051144-97723-9	3" x 3" x 1/4"	P120	9,000	50/100
051141-27356-3†	3" x 3" x 1/2"	60	9,000	50/100
051141-27357-0†	3" x 3" x 1/2"	80	9,000	50/100
051141-27358-7†	3" x 3" x 1/2"	P120	9,000	50/100

† Made-to-Order

3M™ Square Pads 747D

- 3M ceramic aluminum oxide blend abrasive grain on an X wt. cloth backing
- Super aggressive cut rate and durability
- Contains grinding aid for cooler cutting on heat sensitive alloys



UPC	Size	Grade	Max RPM	Qty./Case
1/4–20 Eyelet				
051141-27359-4†	2" x 2" x 1/2"	60	12,000	100
051141-27360-0†	2" x 2" x 1/2"	80	12,000	100
051141-27361-7†	2" x 2" x 1/2"	P120	12,000	100
051141-27362-4†	2" x 2" x 3/8"	60	12,000	100
051141-27363-1†	2" x 2" x 3/8"	80	12,000	100
051141-27364-8†	2" x 2" x 3/8"	P120	12,000	100
051141-27365-5†	3" x 3" x 1/2"	60	9,000	100
051141-27366-2†	3" x 3" x 1/2"	80	9,000	100
051141-27367-9†	3" x 3" x 1/2"	P120	9,000	100

† Made-to-Order

3M™ Cross Pads 341D

- Premium aluminum oxide on an X wt. cloth backing
- Long life and fast cut
- General purpose pads at a value price



UPC	Size	Grade	Max RPM	Min./Case
8 or 10 Ply; 8–32 Eyelet				
051141-27368-6	1" x 1" x 3/8"	60	24,000	50/100
051141-27369-3	1" x 1" x 3/8"	80	24,000	50/100
051141-27370-9†	1" x 1" x 3/8"	P120	24,000	50/100
051141-27371-6	1-1/2" x 1-1/2" x 1/2"	60	24,000	50/100
051141-27372-3	1-1/2" x 1-1/2" x 1/2"	80	24,000	50/100
051141-27373-0	1-1/2" x 1-1/2" x 1/2"	P120	24,000	50/100

10 Ply; 8–32 Eyelet				
051141-27374-7	2" x 2" x 1/2"	60	18,000	50/100
051141-27375-4	2" x 2" x 1/2"	80	18,000	50/100
051141-27376-1	2" x 2" x 1/2"	P120	18,000	50/100
051141-27377-8	2" x 2" x 3/4"	60	18,000	50/100
051141-27378-5	2" x 2" x 3/4"	80	18,000	50/100
051141-27379-2	2" x 2" x 3/4"	P120	18,000	50/100
051144-97750-5	2-1/2" x 2-1/2" x 3/4"	60	18,000	50/100

8 or 10 Ply; 1/4–20 Eyelet				
051141-27380-8	3" x 3" x 1"	60	18,000	50/100
051141-27381-5	3" x 3" x 1"	80	18,000	50/100
051141-27382-2†	3" x 3" x 1"	P120	18,000	50/100
051144-97760-4	3" x 3" x 1-1/2"	60	18,000	50/100
051144-97766-6	3-1/2" x 3-1/2" x 1-1/2"	80	15,000	50/100
051144-97768-0	4" x 4" x 1"	60	12,000	50/100
051144-98880-2	5" x 5" x 1-1/2"	60	10,000	50/100
051144-97783-3	6" x 6" x 1-1/2"	60	9,000	50/100

† Made-to-Order

3M™ Cross Pads 747D

- 3M ceramic aluminum oxide blend abrasive grain on an X wt. cloth backing
- Super aggressive cut rate and durability
- Contains grinding aid for cooler cutting on heat sensitive alloys

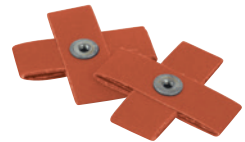

UPC	Size	Grade	Max RPM	Qty./Case
8 Ply; 1/4–20 Eyelet				
051141-20368-3	1-1/2" x 1-1/2" x 1/2"	60	24,000	100
051141-20369-0	1-1/2" x 1-1/2" x 1/2"	80	24,000	100
051141-20372-0	1-1/2" x 1-1/2" x 1/2"	P100	24,000	100
051141-20379-9	1-1/2" x 1-1/2" x 1/2"	P120	24,000	100
051141-20380-5	2" x 2" x 1/2"	60	18,000	100
051141-20367-6	2" x 2" x 1/2"	P100	18,000	100
051141-20375-1	2" x 2" x 3/4"	80	18,000	100

3M™ Bands

Great for getting at those hard to reach places and contours. Ideal for removing parting lines, imperfections and burrs. Use with 3M™ Die Grinders and 3M™ Rubber Slotted Expander Wheel or 3M™ Rubber Cushion Polishing Wheel.

3M™ Bands 341D

- Aluminum oxide on an X wt. cloth backing
- Fast cut and long life
- General purpose evenrun bands at a value price



UPC	Dia. x W	Grade	Max. RPM	Qty./Case
051144-40243-4	1/4" x 1/2"	P80	23,000	100
051144-97428-3	1/4" x 1/2"	P120	23,000	100
051144-27446-7	1/2" x 1/2"	P36	30,000	100
051144-40228-1	1/2" x 1/2"	P60	30,000	100
051144-40227-4	1/2" x 1/2"	P80	30,000	100
051144-40252-6	1/2" x 1/2"	P120	30,000	100
051144-97458-0	1/2" x 1"	P36	15,000	100
051144-40225-0	1/2" x 1"	P60	15,000	100
051144-40224-3	1/2" x 1"	P80	15,000	100
051144-11973-8	1/2" x 1"	P120	15,000	100
051144-11976-9	3/4" x 1"	P36	17,000	100
051144-40221-2	3/4" x 1"	P60	17,000	100
051144-40220-5	3/4" x 1"	P80	17,000	100
051144-40219-9	3/4" x 1"	P120	17,000	100
051144-11977-6	3/4" x 1-1/2"	P36	10,000	100
051144-40241-0	3/4" x 1-1/2"	P80	10,000	100
051144-40214-4	1" x 1"	P36	18,000	100
051144-40211-3	1" x 1"	P60	18,000	100
051144-40210-6	1" x 1"	P80	18,000	100
051144-40208-3	1" x 1"	P120	18,000	100
051144-40207-6	1" x 1-1/2"	P36	10,000	100
051144-11980-6	1" x 1-1/2"	P60	10,000	100
051144-40205-2	1" x 1-1/2"	P80	10,000	100
051144-40203-8	1-1/2" x 1"	P36	14,000	100
051144-40202-1	1-1/2" x 1"	P60	14,000	100
051144-40200-7	1-1/2" x 1-1/2"	P36	10,000	100
051144-40197-0	1-1/2" x 1-1/2"	P60	10,000	100
051144-40196-3	1-1/2" x 1-1/2"	P80	10,000	100
051144-40274-8	1-1/2" x 1-1/2"	P120	10,000	100
051144-40267-0	1-1/2" x 2"	P60	8,000	100
051144-40192-5	2" x 1"	P60	11,000	100
051144-40187-1	2" x 2"	P36	6,000	100
051144-40184-0	2" x 2"	P60	6,000	100
051144-40183-3	2" x 2"	P80	6,000	100
051144-40178-9	3" x 3"	P36	3,000	50
051144-40175-8	3" x 3"	P60	3,000	50
051144-40174-1	3" x 3"	P80	3,000	50
051144-40172-7	3" x 3"	P120	3,000	50

3M™ Bands 747D

- 3M ceramic aluminum oxide blend abrasive grain on an X wt. cloth backing
- Long life and fast cut
- Contains grinding aid for cooler cutting on heat sensitive alloys



UPC	Dia. x W	Grade	Max. RPM	Qty./Case
051144-80765-9	1/2" x 1"	50	15,000	100
051144-80769-7	1/2" x 1"	60	15,000	100
051144-80773-4	1/2" x 1"	80	15,000	100
051144-80766-6	1" x 1"	50	18,000	100
051144-80770-3	1" x 1"	60	18,000	100
051144-80774-1	1" x 1"	80	18,000	100
051144-80782-6	1" x 1"	P120	18,000	100
051144-80771-0	2" x 1"	60	11,000	100
051144-80775-8	2" x 1"	80	11,000	100
051144-80783-3	2" x 1"	P120	11,000	100

Scotch-Brite™ Specialty Abrasives

Scotch-Brite™ Specialty Abrasives

Make tough jobs easy with these Scotch-Brite™ specialty abrasives. Unique constructions for use on contours and flat areas — on metal, wood, paint, coatings and more.

Scotch-Brite™ EXL Unitized Mounted Points

- EXL unitized material dressed to six different ANSI shapes for delicate deburring and finishing of critical parts

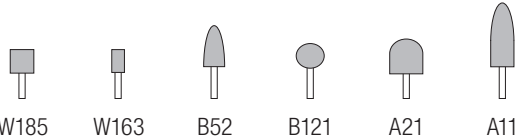

UPC No.	Size	Shape	Density	Grade	Qty./Case
1/4" Shank					
048011-64794-4	7/8" x 2" x 1/4"	A11	8	A MED	50
048011-64795-1	7/8" x 2" x 1/4"	A11	8	S FIN	50
048011-64796-8	1" x 1" x 1/4"	A21	8	A MED	50
048011-64797-5	1" x 1" x 1/4"	A21	8	S FIN	50
1/8" Shank					
048011-64798-2	1/2" x 1/2" x 1/8"	B121	8	A MED	50
048011-64799-9	1/2" x 1/2" x 1/8"	B121	8	A CRS	50
048011-64800-2	3/8" x 3/4" x 1/8"	B52	8	A CRS	50
048011-64801-9	3/8" x 3/4" x 1/8"	B52	8	A MED	50
048011-64802-6	3/8" x 3/4" x 1/8"	B52	8	S FIN	50
048011-64803-3	1/4" x 1/2" x 1/8"	W163	8	A CRS	50
048011-64804-0	1/4" x 1/2" x 1/8"	W163	8	S FIN	50
048011-64805-7	1/4" x 1/2" x 1/8"	W163	8	A MED	50
048011-64806-4	1/2" x 1/2" x 1/8"	W185	8	A CRS	50
048011-64807-1	1/2" x 1/2" x 1/8"	W185	8	A MED	50
048011-64808-8	1/2" x 1/2" x 1/8"	W185	8	S FIN	50

Scotch-Brite™ Radial Bristle Brush, TA

- Excellent replacement for wire brushes
- Use on bench motors for general purpose cleaning applications
- No flying wires yet higher cut rates
- Very strong and flexible
- Comes with adapters for multiple shaft sizes (1/2", 5/8", 3/4", 7/8", 1", 2" and 8")



UPC	Dia. x W	Grade	Color	Max. RPM	Qty./Case
048011-24279-8	3" x 3/8"	50	Green	25,000	40
048011-24280-4	3" x 3/8"	80	Yellow	25,000	40
048011-24281-1	3" x 3/8"	120	White	25,000	40
048011-27603-8	6" x 1/2" x 1"	36	Brown	6,000	5
048011-27605-2	6" x 1/2" x 1"	50	Green	6,000	5
048011-27606-9	6" x 1/2" x 1"	80	Yellow	6,000	5

Scotch-Brite™ Flap Brush CPFB-S and CPFB-R+

- Heavy-duty brush
- Excellent for removing handling marks and surface imperfections
- Available on 1/4" shaft (CPFB-S) or 3M™ Roloc™+ attachment system (CPFB-R+)



UPC	Dia. x W x Shaft	Grade	Max. RPM	Qty./Case
CPFB-S				
048011-16622-3	2" x 1" x 1/4"	A MED	12,000	25
048011-05974-7	3" x 1-3/4" x 1/4"	A MED	8,500	10
CPFB-R+				
048011-14588-4	3" x 1-3/8"	A MED	8,000	10

Scotch-Brite™ Flap Brush CFFB-S and CFFB-R

- Ideal for decorative finishes and light deburring applications
- Available on 1/4" shaft (CFFB-S) or 3M™ Roloc™+ attachment system (CFFB-R)



UPC	Dia. x W x Shaft	Grade	Max. RPM	Qty./Case
CFFB-S				
048011-05975-4	3" x 1-3/4" x 1/4"	A CRS	8,500	10
048011-14781-9	3" x 1-3/4" x 1/4"	S FIN	8,500	10
CFFB-R				
048011-14587-7	3" x 1-3/8"	A CRS	8,000	10
048011-14783-3	3" x 1-3/8"	S FIN	8,000	10

Scotch-Brite™ Combi Wheel, Combi-S

- Made of alternating flaps of coated abrasive and Scotch-Brite™ web
- Provides aggressive cut and fine finishes



UPC	Dia. x W x Shaft	Grade	Max. RPM	Qty./Case
CFFB-S				
051144-80801-4	3" x 1-3/4" x 1/4"	80	8,000	10
051144-80678-2	3" x 1-3/4" x 1/4"	P120	8,000	10
051144-80799-4	3" x 1-3/4" x 1/4"	P180	8,000	10

Scotch-Brite™ Specialty Abrasives

Scotch-Brite™ CPD5-R and CPD5-S Discs

- Five discs made of a durable web, ganged together on a shaft
- Use for satin or antique finishing as well as light- to medium-duty cleaning applications
- Available on a 1/4" shaft (CPD5-S) or 3M™ Roloc™+ attachment system (CPD5-R)



UPC	Dia. x W x (Shaft)	Grade	Max. RPM	Qty./Case
CPD5-S				
048011-14593-8	3" x 1-1/4" x 1/4"	A MED	10,000	10
048011-14779-6	4" x 1-1/4" x 1/4"	A MED	8,000	10
CPD5-R				
048011-14594-5	3" x 1-1/4"	A MED	10,000	10
048011-14590-7	4" x 1-1/4"	A MED	8,000	10

Scotch-Brite™ Clean and Strip Discs D2

- Aggressive web is excellent for cleaning welds, rust, paint and coatings



UPC	Dia. x W x Shaft	Grade	Max. RPM	Qty./Case
048011-14780-2	4" x 1" x 1/4"	S XCS	8,000	10
048011-14784-0	4" x 1"	S XCS	8,000	8

Scotch-Brite™ Stars

- Perfect for polishing internal diameters of pipe and tubing
- Conformable Scotch-Brite™ construction assures complete cleaning and polishing of all surfaces



UPC	Diameter	Grade	Max. RPM	Qty./Case
048011-13370-6	1-1/2"	A CRS	24,000	100
048011-13800-8	1-1/2"	A VFN	24,000	100
048011-13371-3	2"	A CRS	24,000	100
048011-13803-9	2"	A VFN	24,000	100
048011-13372-0	3"	A CRS	18,000	50
048011-13802-2	3"	A VFN	18,000	50
048011-13373-7	4"	A CRS	18,000	50
048011-13804-6	4"	A VFN	18,000	50

Scotch-Brite™ Cross Buffs

- Versatile and flexible shape ideal for light deburring, cleaning, finishing and polishing internal diameters and hard to reach areas
- Available in A VFN for high luster finishes or A MED for more aggressive applications requiring increased durability



UPC	Diameter	Grade	Max. RPM	Qty./Case
048011-64299-4	1" x 3/8" x 2 PLY x 8-32	A MED	20,000	50
048011-64446-2	1" x 3/8" x 2 PLY x 8-32	A VFN	20,000	50
048011-64305-2	1-1/2" x 3/8" x 2 PLY x 8-32	A MED	20,000	50
048011-64526-1	1-1/2" x 3/8" x 2 PLY x 8-32	A VFN	20,000	50
048011-64447-9	1-1/2" x 1/2" x 2 PLY x 8-32	A VFN	20,000	100
048011-64312-0	2" x 1/2" x 2 PLY x 8-32	A MED	12,000	25
048011-64433-2	2" x 1/2" x 2 PLY x 8-32	A VFN	12,000	25

Scotch-Brite™ Unitized Wheel Pack 990S

- Contains several Scotch-Brite™ external Unitized Wheels 1" x 1" x 3/16" and 3" x 1/4" x 3/8" in a variety of densities and grades
- Also includes 936 and 990 mandrels



UPC	Size	Min./Case
048011-18245-2	1" x 1" x 3/16" and 3" x 1/4" x 3/8"	1/5



3M™ Power Tools for Specialty Abrasives

3M™ Die Grinders — 1 HP

- Powerful 1 HP die grinders are excellent for big jobs such as weld or stock removal
- 3M™ Gripping Material for added comfort and reduced vibration



Model No.	Motor HP (W)	Max RPM	Weight Pound (kg)	Length Inch (mm)	Air Inlet Thread	Collet Size	Airflow Rate SCFM (LPM)	UPC
20237	1 (744)	20,000	1.69 (.77)	7.75 (196.9)	1/4" NPT	1/4"	37 (1,048)	051141-20237-2
20238	1 (744)	18,000	1.69 (.77)	7.75 (196.9)	1/4" NPT	1/4"	37 (1,048)	051141-20238-9
NEW! 28770	1 (744)	18,000	2.60 (1.2)	13 (318)	1/4" NPT	1/4"	37 (1,084)	051141-28770-6
20239	1 (744)	12,000	2.06 (.93)	10 (254)	1/4" NPT	1/4"	37 (1,048)	051141-20239-6
20240	1 (744)	8,000	2.06 (.93)	10 (254)	1/4" NPT	1/4"	37 (1,048)	051141-20240-2

3M™ Die Grinders — 0.5 HP

- Ideal for a variety of polishing, buffing, shaping and deburring applications
- 3M™ Gripping Material for added comfort and reduced vibration
- Available in extended shaft models



Model No.	Motor HP (W)	Max RPM	Weight Pound (kg)	Length Inch (mm)	Air Inlet Thread	Collet Size	Airflow Rate SCFM (LPM)	UPC
28330	0.5 (372)	18,000	1.13 (.512)	6.88 (174.6)	1/4" NPT	1/4"	26 (736)	051141-28330-2
28331	0.5 (372)	18,000*	1.54 (.697)	10.63 (269.9)	1/4" NPT	1/4"	26 (736)	051141-28331-9
28332	0.5 (372)	4,000	1.58 (.717)	8.88 (200)	1/4" NPT	1/4"	26 (736)	051141-28332-6

*With extension

3M™ Die Grinders — 0.3 HP

- Ideal for deburring, blending, finishing and polishing intricate and hard-to-reach areas
- 3M™ Gripping Material for added comfort and reduced vibration
- Available in extended shaft models



Model No.	Motor HP (W)	Max RPM	Weight Pound (kg)	Length Inch (mm)	Air Inlet Thread	Collet Size	Airflow Rate SCFM (LPM)	UPC
28630	0.3 (224)	25,000	1.40 (.639)	10 (254)	1/4" NPT	1/4"†	17 (481)	051141-28630-3
28629	0.3 (224)	25,000	0.89 (.405)	6.125 (156)	1/4" NPT	1/4"†	17 (481)	051141-28629-7
28628	0.3 (224)	18,000	1.52 (.690)	10 (254)	1/4" NPT	1/4"†	17 (481)	051141-28628-0
28627	0.3 (224)	18,000	1.15 (.522)	7.25 (184)	1/4" NPT	1/4"†	17 (481)	051141-28627-3

†Includes 1/8" collet insert

3M™ Match and Finish Sander

- Generate straight-line scratches for finishing stainless steel and other metals
- Front to back motion helps prevent curved scratches
- Easy to control for reduced start/stop marks
- Easy screw-on/screw-off attachments
- Design for use with Scotch-Brite™ Match and Finish Flap Brushes, 3M™ Abrasive Belts or Scotch-Brite™ Belts*







Model No.	Motor HP (W)	Max RPM	Weight Pound (kg)	Length Inch (mm)	Air Inlet Thread	Airflow Rate SCFM (LPM)	Shaft Size	UPC
28659	1 (744)	3,500	4.6 (2.1)	13.5 (343)	1/4" NPT	37 (1,048)	5/8"-11 EXT	051141-28659-4

*To run belt products, 3M™ Expander Wheel (28718) and Adapter Kit (28719) are required. See page 68.

Accessories for Specialty Abrasives

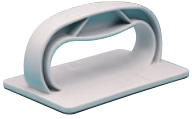
Product Name	UPC	Qty./Case	For Use With	Size/Description	Max RPM
Mandrel No. 944 	048011-13928-9	1	Scotch-Brite™ Stars for cleaning and polishing internal diameters of pipe and tubing	1/4" x 1/4-20 EXT	25,100
3M™ Mandrel 	048011-14307-8	1	Scotch-Brite™ Cross Buffs for cleaning and polishing internal diameters of pipe and tubing	1/4" x 8-32 EXT	Dependent upon abrasive product used
3M™ Mandrels 	051144-45119-7	25	Screw-type mandrels for securing cartridge rolls to tool	1/8" x 1" x 1/4"	24,000 (1/2" and smaller cartridge roll diameter); 16,000 (5/8" - 3/4" cartridge roll diameter)
	051144-45117-3	25	Screw-type mandrels for securing cartridge rolls to tool	3/16" x 1" x 1/4"	
	051144-45118-0	25	Screw-type mandrels for securing cartridge rolls to tool	3/16" x 1-1/2" x 1/4"	
3M™ Square and Cross Pad Mandrel 	051144-14308-5	1		1/4" x 1/4-20 EXT	Dependent upon abrasive product used
	051144-14307-8	1	Used for holding square and cross pads with 1/4-20 and 8-32 internal threaded inserts	1/4" x 8-32 EXT	
	051141-28385-2	5		1/4" x 3-48 EXT	
Forked Spindle 	051144-45121-0	10	For attaching utility cloth strips	1/4" x 3"	N/A
3M™ Wetordry™ Sponge Pad 	051131-05526-1	50	Wetordry™ Paper Sheets	2-3/4" x 5-1/2" x 3/8"	N/A
3M™ Stikit™ Soft Hand Pad 	051144-05530-2	5/10	Stikit™ Sheet Rolls	2-3/4" x 5-1/2" x 3/8"	N/A

Accessories for Specialty Abrasives

Product Name	UPC	Qty./Case	For Use With	Size/Description	Max RPM
 <p>Scotch-Brite™ Pad Holder No. 961</p>	048011-09493-4	10	Scotch-Brite™ Hand Pads; Provides increased leverage and eliminates “finger” marks	3-1/2" x 4-3/4"	N/A
 <p>Mini Mandrel No. 935</p>	048011-04020-2	5	Scotch-Brite™ Strips to clean and polish inner diameters and other tight areas	2-7/8" x 1/4"	14,000
 <p>3M™ Match and Finish Rubber Slotted Expander Wheel</p>	Use 3M™ Expander Wheel and Adapter Kit with 3M™ Match and Finish Sander NEW!				
 <p>NEW!</p>	051141-28718-8	1	3-1/2" x 15-1/2" belts	5" x 3-1/2" x 1" AH	3,500
 <p>NEW!</p>	051141-27819-5	1	To mount 28718 wheel on 3M™ Match and Finish Sander	1" x 5/8–11 INT	N/A

Superabrasive Wheels for Cutting Tool Manufacturing

The superabrasive products featured in this catalog are 3M's best, "go-to" wheels for cutting tool applications ranging from short runs and re-sharpening to "lights-out" and long production runs. All are in-stock, and are available for fast, two-day shipping within the U.S.

2-Day Shipping
on stock wheels
within the U.S.!

Typical Abrasive Wheels Used for Round Tool Grinding

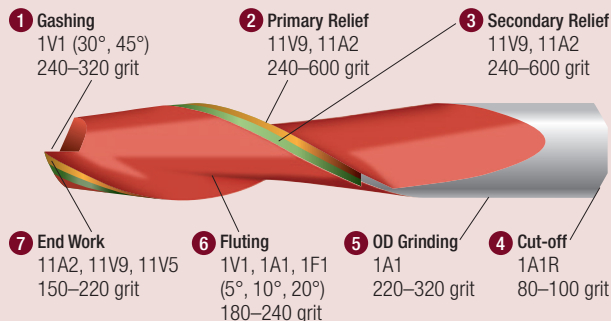

- 1 Gashing:** Grinding a slot or notch along the cutting face to allow for chip flow
- 2 Primary Relief:** Removing material directly behind the cutting edge to provide clearance
- 3 Secondary Relief:** A slight bevel next to the primary relief
- 4 Cut-off:** Using a thin wheel to trim blanks to length; Typically used on the cutting end of the tool when re-grinding and on the shank end when forming a blank
- 5 OD Grinding:** Grinding to final diameter
- 6 Fluting:** Flutes are the helical or straight grooves in the body of the tool; This provides a pathway to permit the removal of chips, and to allow coolants to reach the cutting surface
- 7 End Work:** Grinding a small clearance, or relief angle, on the face (tip) of the tool

When to use Diamond vs. CBN

For optimal grinding results, make sure you know what material the tools are made of.

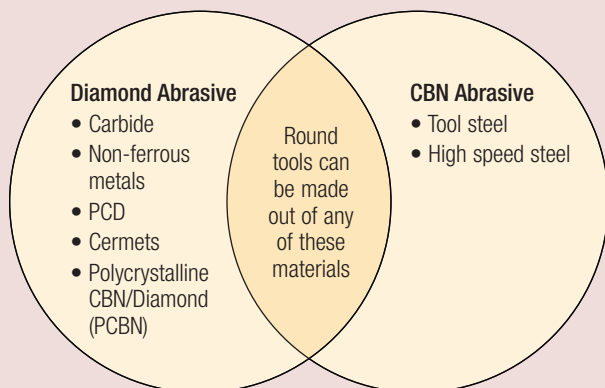

Can't find what you need?

Simply provide us with the following information, and we'll help you select the optimal product for your application. **Contact 3M Customer Service for more information.**

To order, specify: Wheel Shape, Dimension, Mineral, Grade and Product ID

1. Are you manufacturing new tools or resharpening?

- Manufacturing Resharpening

2. What is your application?

- Fluting OD Grinding Step Grinding
 Gashing Primary Relief End Work
 Secondary Relief Other _____

3. What kind of material are you grinding?

- Carbide High Speed Steel Other _____

4. What type of equipment are you using?

- CNC Grinder Manual Tool & Cutter Other _____

If CNC Grinder...what is the model?

- ANCA—HP _____ Walters—HP _____
 Rollomatic—HP _____ Tru Tech—HP _____
 Other HP _____

5. What type of coolant are you using?

- Straight Oil Water Based Other _____
 Chilled? Yes No

6. What is the size/grade of your wheel(s)?

Shape	Diameter	Thickness	Hole	Grade
1F1				
1V1				
11A2				
12A2				
11V9				
12V9				
1A1R				
Other:				

Also Specify:

Radius _____ Rim Width _____
 Face Angle _____ Rim Width _____

7. What do you want to change/accomplish?

- Cut Faster Less Frequent Sticking Other _____
 Better Finishing Run Longer Without Re-truing

8. Which wheels have you tried?

Which 3M wheels in this brochure have you tested? _____

If none, what wheels do you currently use? _____

Fluting Wheel Performance Characteristics

3M has six standard constructions that are ideal for a variety of different operations.

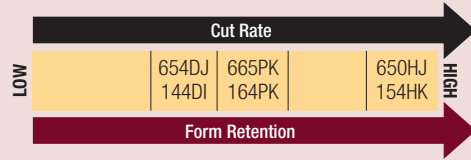

Product Performance (Diamond / CBN)		
654DJ / 144DI <ul style="list-style-type: none"> Phenolic resin bond Good cut rate/stock removal Holds shape Use for lower temperature operations Can be run with water Ideal for small re-grind shops or in-house re-sharpening 	665PK / 164PK <ul style="list-style-type: none"> Polyimide resin bond Higher cut rate/fast stock removal Better form retention Designed for higher temperature operations 	650HJ / 154HK <ul style="list-style-type: none"> Hybrid bond Fastest cut rate Best form retention Designed for higher temperature operations than polyimide bond Reduced frequency of dressing and minimal "white sticking" required Ideal for long, uninterrupted runs

2-Day Shipping
on stock wheels
within the U.S.!

3M™ Fluting Wheels

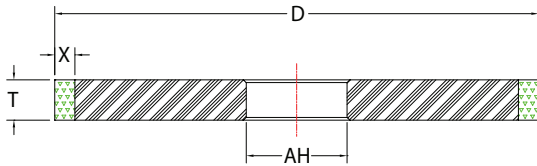

3M™ Fluting Wheel — Shape 1A1

Dimensions D × T × AH*	Grade	Bond**	Prod ID	UPC	Min./Case
Diamond Abrasive — 1A1					
4" × 1/4" × AH* X = 3/8	D220	H	650HJ	051141-31270-5	1
	D220	P	665PK	051141-54806-7	1
	D220	R	654DJ	051141-31288-0	1
4" × 3/8" × AH* X = 3/8	D220	H	650HJ	051141-31273-6	1
	D220	P	665PK	051141-54809-8	1
	D220	R	654DJ	051141-31291-0	1
4" × 1/2" × AH* X = 3/8	D220	H	650HJ	051141-31267-5	1
	D220	P	665PK	051141-54803-6	1
	D220	R	654DJ	051141-31285-9	1
5" × 1/4" × AH* X = 3/8	D220	H	650HJ	051141-31279-8	1
	D220	P	665PK	051141-54823-4	1
	D220	R	654DJ	051141-31297-2	1
5" × 3/8" × AH* X = 3/8	D220	H	650HJ	051141-31282-8	1
	D220	P	665PK	051141-54828-9	1
	D220	R	654DJ	051141-54800-5	1

* Arbor hole is made to customer spec. Please specify on order.
** H=Hybrid P=Polyimide R=Resin

3M™ Fluting Wheel — Shape 1A1 (cont.)

Dimensions D × T × AH*	Grade	Bond**	Prod ID	UPC	Min./Case
Diamond Abrasive — 1A1 (cont.)					
5" × 1/2" × AH* X = 3/8	D220	H	650HJ	051141-31276-7	1
	D220	P	665PK	051141-54820-3	1
	D220	R	654DJ	051141-31294-1	1
5" × 3/4" × AH* X = 3/8	D220	H	650HJ	051141-54916-3	1
	D220	P	665PK	051141-54917-0	1
	D220	R	654DJ	051141-54918-7	1
6" × 1/2" × AH* X = 3/8	D220	H	650HJ	051141-55462-4	1
	D220	P	665PK	051141-55464-8	1
	D220	R	654DJ	051141-55463-1	1
CBN Abrasive — 1A1					
4" × 1/2" × AH* X = 3/8	B180	H	154HK	051141-55465-5	1
	B180	P	164PK	051141-55466-2	1
	B180	R	144DI	051141-55467-9	1
5" × 1/2" × AH* X = 3/8	B180	H	154HK	051141-55468-6	1
	B180	P	164PK	051141-55469-3	1
	B180	R	144DI	051141-55470-9	1
6" × 1/2" × AH* X = 3/8	B180	H	154HK	051141-55471-6	1
	B180	P	164PK	051141-55472-3	1
	B180	R	144DI	051141-55473-0	1

* Arbor hole is made to customer spec. Please specify on order.
** H=Hybrid P=Polyimide R=Resin

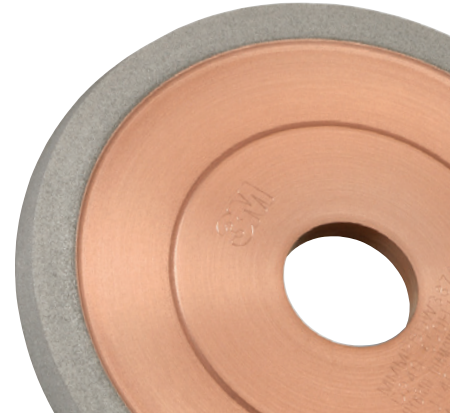

Flute Grinding

Flutes are the helical or straight grooves in the body of the tool. This provides a pathway to permit the removal of chips, and to allow coolants to reach the cutting surface.

2-Day Shipping
on stock wheels
within the U.S.!

3M™ Fluting Wheels

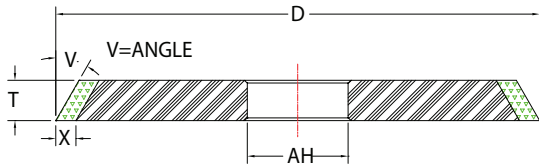

3M™ Fluting Wheel — Shape 1V1

Dimensions D × T × AH*	Grade	Bond**	Prod ID	UPC	Min./Case
Diamond Abrasive — 1V1					
4" × 1/4" × AH*	D220	H	650HJ	051141-31268-2	1
	D220	P	665PK	051141-54804-3	1
	D220	R	654DJ	051141-31286-6	1
4" × 1/4" × AH*	D220	H	650HJ	051141-31269-9	1
	D220	P	665PK	051141-54805-0	1
	D220	R	654DJ	051141-31287-3	1
4" × 3/8" × AH*	D220	H	650HJ	051141-31271-2	1
	D220	P	665PK	051141-54807-4	1
	D220	R	654DJ	051141-31289-7	1
4" × 3/8" × AH*	D220	H	650HJ	051141-31272-9	1
	D220	P	665PK	051141-54808-1	1
	D220	R	654DJ	051141-31290-3	1
4" × 1/2" × AH*	D220	H	650HJ	051141-31265-1	1
	D220	P	665PK	051141-54801-2	1
	D220	R	654DJ	051141-31283-5	1
4" × 1/2" × AH*	D220	H	650HJ	051141-31266-8	1
	D220	P	665PK	051141-54802-9	1
	D220	R	654DJ	051141-31284-2	1
5" × 1/4" × AH*	D220	H	650HJ	051141-31277-4	1
	D220	P	665PK	051141-54821-0	1
	D220	R	654DJ	051141-31295-8	1
5" × 1/4" × AH*	D220	H	650HJ	051141-31278-1	1
	D220	P	665PK	051141-54822-7	1
	D220	R	654DJ	051141-31296-5	1

* Arbor hole is made to customer spec. Please specify on order.

** H=Hybrid P=Polyimide R=Resin

3M™ Fluting Wheel — Shape 1V1 (cont.)

Dimensions D × T × AH*	Grade	Bond**	Prod ID	UPC	Min./Case
Diamond Abrasive — 1V1 (cont.)					
5" × 3/8" × AH*	D220	H	650HJ	051141-31280-4	1
	D220	P	665PK	051141-54826-5	1
	D220	R	654DJ	051141-31298-9	1
5" × 3/8" × AH*	D220	H	650HJ	051141-31281-1	1
	D220	P	665PK	051141-54827-2	1
	D220	R	654DJ	051141-31299-6	1
5" × 1/2" × AH*	D220	H	650HJ	051141-31274-3	1
	D220	P	665PK	051141-54818-0	1
	D220	R	654DJ	051141-31292-7	1
5" × 1/2" × AH*	D220	H	650HJ	051141-31275-0	1
	D220	P	665PK	051141-54819-7	1
	D220	R	654DJ	051141-31293-4	1
5" × 3/4" × AH*	D220	H	650HJ	051141-54919-4	1
	D220	P	665PK	051141-54920-0	1
	D220	R	654DJ	051141-54921-7	1
CBN Abrasive — 1V1					
4" × 1/2" × AH*	B180	H	154HK	051141-55474-7	1
	B180	P	164PK	051141-55475-4	1
	B180	R	144DI	051141-55476-1	1
5" × 1/2" × AH*	B180	H	154HK	051141-55477-8	1
	B180	P	164PK	051141-55478-5	1
	B180	R	144DI	051141-55479-2	1
6" × 1/2" × AH*	B180	H	154HK	051141-55480-8	1
	B180	P	164PK	051141-55481-5	1
	B180	R	144DI	051141-55482-2	1

* Arbor hole is made to customer spec. Please specify on order.

** H=Hybrid P=Polyimide R=Resin

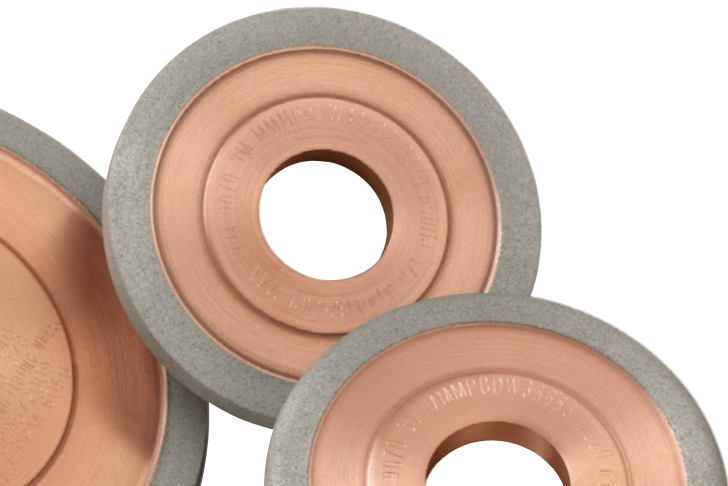

Wheel Performance Characteristics

3M™ Superabrasive Wheels are available in a variety of constructions, each with its own unique characteristics. Choose the 3M Wheel with the best balance of form retention and cut rate for your application.

- Primary and Secondary Relief Wheels
- Gashing Wheels
- Wheels for End Work

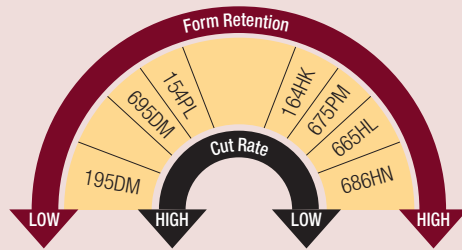

- | | |
|--|---|
| <ul style="list-style-type: none"> • Less Form Retention • Shorter Production Runs • Free Cutting • Fast Cutting | <ul style="list-style-type: none"> • Best Form Retention • Close Tolerances • Long Wheel Life • Long Production Runs • Slower Cut Rate |
|--|---|

2-Day Shipping
on stock wheels
within the U.S.!

3M™ Primary and Secondary Relief Wheels

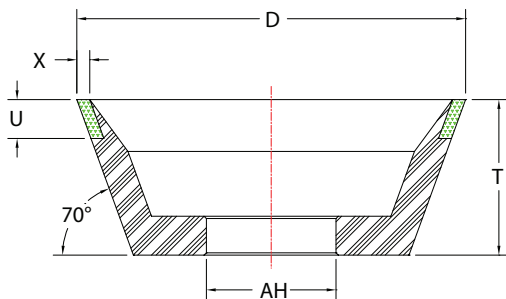

3M™ Primary and Secondary Relief Wheel — Shape 11V9

Dimensions D × T × AH*	Grade	Bond**	Prod ID	UPC	Min./Case
Diamond Abrasive — 11V9					
3-3/4" × 1-1/2" × AH* X = 1/8 U = 3/8	D220	H	686HN	051141-54864-7	1
	D220	P	675PM	051141-54837-1	1
	D220	R	695DM	051141-54869-2	1
	D280	H	686HN	051141-54865-4	1
	D280	P	675PM	051141-54838-8	1
	D280	R	695DM	051141-54870-8	1
	D320	H	686HN	051141-54866-1	1
	D320	P	675PM	051141-54839-5	1
	D320	R	695DM	051141-54871-5	1
	D400	H	686HN	051141-54867-8	1
	D400	P	675PM	051141-54840-1	1
	D400	R	695DM	051141-54872-2	1
5" × 1-3/4" × AH* X = 1/8 U = 7/16	D220	H	686HN	051141-54927-9	1
	D320	H	686HN	051141-54868-5	1
	D320	P	675PM	051141-54855-5	1
D320	R	695DM	051141-54887-6	1	

* Arbor hole is made to customer spec. Please specify on order.
** H=Hybrid P=Polyimide R=Resin

3M™ Primary and Secondary Relief Wheel — Shape 11V9 (cont.)

Dimensions D × T × AH*	Grade	Bond**	Prod ID	UPC	Min./Case
CBN Abrasive — 11V9					
3-3/4" × 1-1/2" × AH* X = 1/8 U = 3/8	B220	H	164HK	051141-31244-6	1
	B220	P	154PL	051141-31233-0	1
	B220	R	195DM	051141-31254-5	1
5" × 1-3/4" × AH* X = 1/8 U = 7/16	B220	H	164HK	051141-31251-4	1
	B220	P	154PL	051141-31239-2	1
	B220	R	195DM	051141-31261-3	1

* Arbor hole is made to customer spec. Please specify on order.
** H=Hybrid P=Polyimide R=Resin

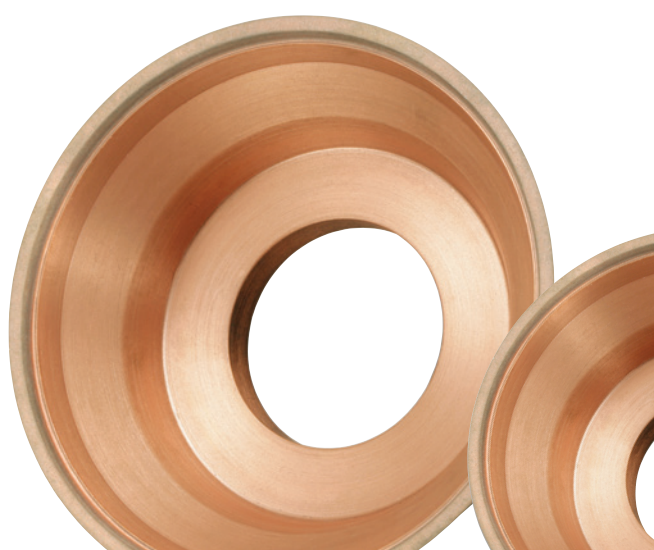

Primary and Secondary Relief Grinding

Cutting edges are typically “relieved” to enhance chip clearance. Primary relief involves removing material directly behind the cutting edge. For secondary relief, a slight bevel is ground next to the primary relief.

2-Day Shipping on stock wheels within the U.S.!

3M™ Primary and Secondary Relief Wheels

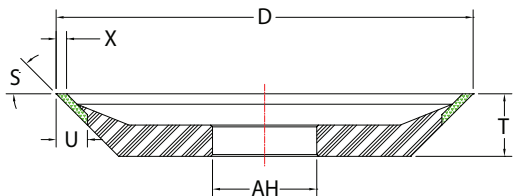

3M™ Primary and Secondary Relief Wheel — Shape 12V9

• Can also be used for gashing (See page 106 for additional Gashing Wheels)

Dimensions D × T × AH*	Grade	Bond**	Prod ID	UPC	Min./Case
Diamond Abrasive — 12V9					
4" × 3/4" × AH* X = 1/8; U = 3/8 S = 30°	D320	H	665HL	051141-54814-2	1
	D320	P	675PM	051141-54847-0	1
	D320	R	695DM	051141-54879-1	1
4" × 3/4" × AH* X = 1/8; U = 3/8 S = 45°	D320	H	665HL	051141-54813-5	1
	D320	P	675PM	051141-54846-3	1
	D320	R	695DM	051141-54878-4	1
5" × 3/4" × AH* X = 1/8; U = 3/8 S = 30°	D320	H	665HL	051141-54831-9	1
	D320	P	675PM	051141-54856-2	1
	D320	R	695DM	051141-54888-3	1
5" × 3/4" × AH* X = 1/8; U = 3/8 S = 45°	D320	H	665HL	051141-54832-6	1
	D320	P	675PM	051141-54857-9	1
	D320	R	695DM	051141-54889-0	1
CBN Abrasive — 12V9					
4" × 3/4" × AH* X = 1/8; U = 3/8 S = 30°	B220	H	164HK	051141-31250-7	1
	B220	P	154PL	051141-31236-1	1
	B220	R	195DM	051141-31258-3	1
4" × 3/4" × AH* X = 1/8; U = 3/8 S = 45°	B220	R	195DM	051141-31257-6	1
	B220	H	164HK	051141-31252-1	1
5" × 3/4" × AH* X = 1/8; U = 3/8 S = 30°	B220	P	154PL	051141-31240-8	1
	B220	R	195DM	051141-31262-0	1
	B220	H	164HK	051141-31253-8	1
5" × 3/4" × AH* X = 1/8; U = 3/8 S = 45°	B220	P	154PL	051141-31241-5	1
	B220	R	195DM	051141-31263-7	1

* Arbor hole is made to customer spec. Please specify on order.

** H=Hybrid P=Polyimide R=Resin

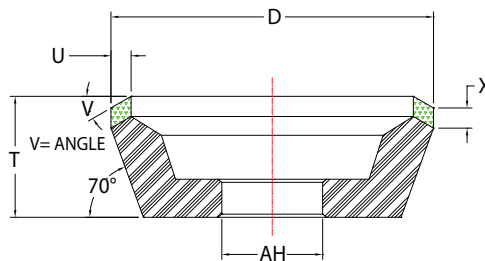

3M™ Primary and Secondary Relief Wheel — Shape 11V5

• Can also be used for gashing (See page 106 for additional Gashing Wheels)

Dimensions D × T × AH*	Grade	Bond**	Prod ID	UPC	Min./Case
Diamond — 11V5					
4" × 1-1/2" × AH* X = 1/4; U = 1/4 V = 30°	D320	H	665HL	051141-54895-1	1
	D320	P	675PM	051141-54894-4	1
	D320	R	695DM	051141-54893-7	1

* Arbor hole is made to customer spec. Please specify on order.

** H=Hybrid P=Polyimide R=Resin



2-Day Shipping
on stock wheels
within the U.S.!

3M™ Gashing Wheels

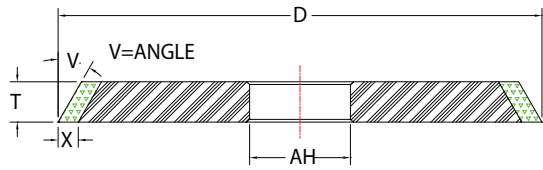

3M™ Gashing Wheel — Shape 1V1

• Wheel shapes 12V9 and 11V5 are also commonly used for gashing (See page 105)

Dimensions D × T × AH*	Grade	Bond**	Prod ID	UPC	Min./Case
Diamond Abrasive — 1V1					
4 × 1/4 × AH* X = 3/8 V = 30°	D280	H	665HL	051141-54810-4	1
	D280	P	675PM	051141-54842-5	1
	D280	R	695DM	051141-54875-3	1
4 × 3/8 × AH* X = 3/8 V = 20°	D320	H	665HL	051141-54815-9	1
	D320	P	675PM	051141-54848-7	1
	D320	R	695DM	051141-54880-7	1
4 × 3/8 × AH* X = 3/8 V = 30°	D320	H	665HL	051141-54816-6	1
	D320	P	675PM	051141-54849-4	1
	D320	R	695DM	051141-54881-4	1
4 × 3/8 × AH* X = 3/8 V = 45°	D320	H	665HL	051141-54817-3	1
	D320	P	675PM	051141-54850-0	1
	D320	R	695DM	051141-54882-1	1
5 × 3/8 × AH* X = 3/8 V = 20°	D320	H	665HL	051141-54833-3	1
	D320	P	675PM	051141-54858-6	1
	D320	R	695DM	051141-54890-6	1
5 × 3/8 × AH* X = 3/8 V = 30°	D320	H	665HL	051141-54834-0	1
	D320	P	675PM	051141-54859-3	1
	D320	R	695DM	051141-54891-3	1
5 × 3/8 × AH* X = 3/8 V = 45°	D320	H	665HL	051141-54835-7	1
	D320	P	675PM	051141-54860-9	1
	D320	R	695DM	051141-54926-2	1
6 × 3/8 × AH* X = 3/8 V = 30°	D280	H	665HL	051141-54836-4	1
	D280	P	675PM	051141-54861-6	1
	D280	R	695DM	051141-54892-0	1

* Arbor hole is made to customer spec. Please specify on order.

** H=Hybrid P=Polyimide R=Resin

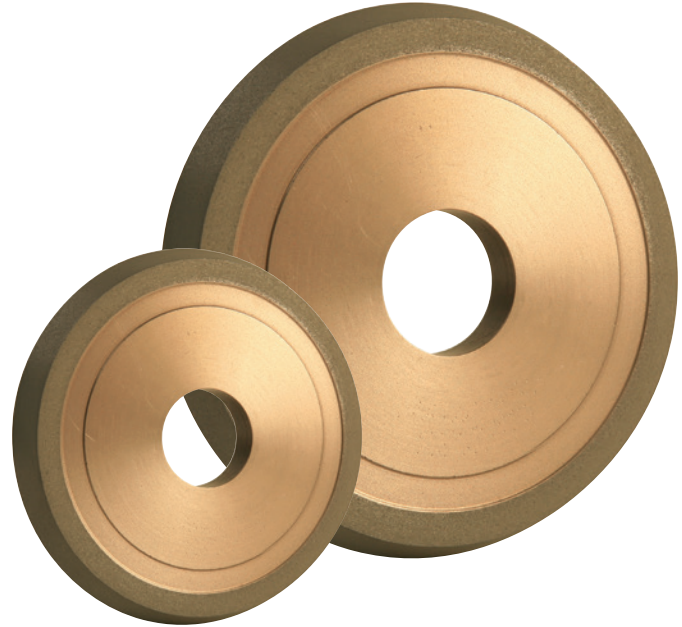

3M™ Gashing Wheel — Shape 1V1 (cont.)

Dimensions D × T × AH*	Grade	Bond**	Prod ID	UPC	Min./Case
CBN Abrasive — 1V1					
4 × 3/8 × AH* X = 3/8 V = 30°	B220	P	154PL	051141-31237-8	1
	B220	R	195DM	051141-31259-0	1
4 × 3/8 × AH* X = 3/8 V = 45°	B220	P	154PL	051141-31238-5	1
	B220	R	195DM	051141-31260-6	1
5 × 3/8 × AH* X = 3/8 V = 30°	B220	P	154PL	051141-31242-2	1
	B220	R	195DM	051141-31264-4	1
5 × 3/8 × AH* X = 3/8 V = 45°	B220	P	154PL	051141-31243-9	1
	B220	R	195DM	051141-31264-4	1

* Arbor hole is made to customer spec. Please specify on order.

** H=Hybrid P=Polyimide R=Resin

Gashing

Gashing involves grinding a slot or notch along the cutting face to allow for chip flow.

2-Day Shipping on stock wheels within the U.S.!

3M™ Wheels for End Work

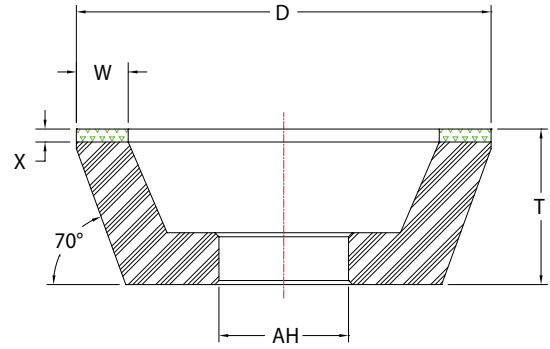
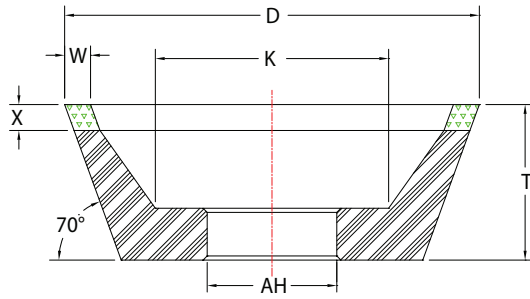

3M™ Wheel for End Work — Shape 11V2

Dimensions D × T × AH*	Grade	Bond**	Prod ID	UPC	Min./Case
Diamond Abrasive — 11V2					
4" × 1-1/2" × AH* X = 1/4 W = 1/4	D220	H	665HL	051141-54862-3	1
	D220	P	675PM	051141-54841-8	1
	D220	R	695DM	051141-54873-9	1
	D320	H	665HL	051141-54863-0	1
	D320	P	675PM	051141-54843-2	1
	D320	R	695DM	051141-54876-0	1
CBN Abrasive — 11V2					
4" × 1-1/2" × AH* X = 1/4 W = 1/4	B220	H	164HK	051141-31248-4	1
	B220	P	154PL	051141-31234-7	1
	B220	R	195DM	051141-31255-2	1

* Arbor hole is made to customer spec. Please specify on order.
** H=Hybrid P=Polyimide R=Resin

3M™ Wheel for End Work — Shape 11A2

Dimensions D × T × AH*	Grade	Bond**	Prod ID	UPC	Min./Case
Diamond Abrasive — 11A2					
4" × 1-1/4" × AH* X = 1/4 W = 1/4	D320	H	665HL	051141-54811-1	1
	D320	P	675PM	051141-54844-9	1
	D320	R	695DM	051141-54922-4	1
	D220	R	695DM	051141-54874-6	1
4" × 1-1/4" × AH* X = 1/4 W = 3/8	D320	H	665HL	051141-54812-8	1
	D320	P	675PM	051141-54845-6	1
	D320	R	695DM	051141-54877-7	1
	D220	H	665HL	051141-54824-1	1
5" × 1-1/2" × AH* X = 1/4 W = 1/4	D220	P	675PM	051141-54851-7	1
	D220	R	695DM	051141-54883-8	1
	D320	H	665HL	051141-54829-6	1
	D320	P	675PM	051141-54853-1	1
5" × 1-1/2" × AH* X = 1/4 W = 3/8	D320	R	695DM	051141-54885-2	1
	D220	H	665HL	051141-54825-8	1
	D220	P	675PM	051141-54852-4	1
	D220	R	695DM	051141-54884-5	1
5" × 1-1/2" × AH* X = 1/4 W = 3/8	D320	H	665HL	051141-54830-2	1
	D320	P	675PM	051141-54854-8	1
	D320	R	695DM	051141-54886-9	1
	CBN Abrasive — 11A2				
4" × 1-1/4" × AH* X = 1/4 W = 1/4	B220	H	164HK	051141-31249-1	1
	B220	P	154PL	051141-31235-4	1
	B220	R	195DM	051141-31256-9	1
4" × 1-1/4" × AH* X = 1/4 W = 3/8	B220	H	164HK	051141-54923-1	1
	B220	P	154PL	051141-54924-8	1
	B220	R	195DM	051141-54925-5	1

* Arbor hole is made to customer spec. Please specify on order.
** H=Hybrid P=Polyimide R=Resin



End Work

Grinding a small clearance, or relief, angle on the face (tip) of the tool to reduce the contact area between the tool and workpiece.

3M™ Cut-Off Wheels

2-Day Shipping
on stock wheels
within the U.S.!

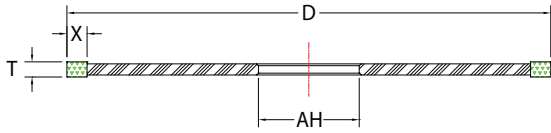

3M™ Cut-Off Wheel — Shape 1A1R



- Thin abrasive wheels used to trim blanks to length
- Typically used on the cutting end of the tool when re-grinding and on the shank end when forming a blank

Dimensions D × T × AH	Grade	Prod ID	UPC	Min./Case
Diamond Abrasive — 1A1R				
6" × 0.35" × 1-1/4" X = 1/4	D100	654BJ	051141-54951-4	1
	D100	654BK	051141-30581-3	1
	D100	675BM	051141-54952-1	1
	D120	664BL	051141-54953-8	1
	D220	654BJ	051141-54954-5	1

Performance Characteristics

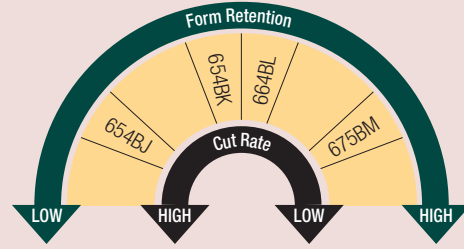

- | | |
|--|---|
| <ul style="list-style-type: none"> • Less Form Retention • Shorter Production Runs • Free Cutting • Fast Cutting | <ul style="list-style-type: none"> • Best Form Retention • Close Tolerances • Long Wheel Life • Long Production Runs • Slower Cut Rate |
|--|---|

Cut-Off Wheels

These thin abrasive wheels are used to trim blanks to length. They are typically used on the cutting end of the tool when re-grinding and on the shank end when forming a blank.

3M™ Truing and Dressing Products

3M™ Dressing Wheels

- Silicon carbide dressing wheels are used to true and dress superabrasive grinding wheels



2-Day Shipping
on stock wheels
within the U.S.!

Dimensions D × T × AH	Grade*	Prod ID	UPC	Min./Case
Silicon Carbide Abrasive				
8" × 1/2" × 1-1/4"	C80	400TI	051141-54900-2	1
	GC80	400TI	051141-54906-4	1
	C80	400TI	051141-54901-9	1
	C80	400TK	051141-54910-1	1
8" × 1/4" × 1-1/4"	GC80	400TI	051141-54907-1	1
	GC80	400TG	051141-54896-8	1
	GC80	400TH	051141-54898-2	1
	GC220	400TI	051141-54905-7	1

*GC = Green Silicon Carbide — Premium quality for longer life
C = Black Silicon Carbide — Standard quality, softer construction provides freer and faster cut

3M™ Dressing Wheels (cont.)

Dimensions D × T × AH	Grade*	Prod ID	UPC	Min./Case
Silicon Carbide Abrasive				
8" × 3/4" × 1-1/4"	C80	400TI	051141-54902-6	1
	C80	400TK	051141-54911-8	1
	GC80	400TI	051141-54908-8	1
8" × 3/8" × 1-1/4"	C80	400TI	051141-54903-3	1
	C80	400TK	051141-54912-5	1
	GC80	400TH	051141-54899-9	1
	GC80	400TG	051141-54897-5	1
	GC80	400TI	051141-54909-5	1
	GC120	400TI	051141-54904-0	1

*GC = Green Silicon Carbide — Premium quality for longer life
C = Black Silicon Carbide — Standard quality, softer construction provides freer and faster cut

3M™ Truing and Dressing Products

3M™ DSD Truing Tools

- Made of a 3M proprietary alloy
- Excellent for truing resin bond diamond and CBN wheels
- Will true straight ODs, angles or sides of wheels
- Must be used without coolant



2-Day Shipping
on stock wheels
within the U.S.!

Size D x L	Application	UPC	Min./Case
1/4" x 1-3/4"	For use with 3M™ Holding Blocks	051115-20817-1	1
3/8" x 1-3/4"	For use with 3M™ Holding Blocks	051115-20818-8	1
1/2" x 2"	For use with 3M™ Holding Blocks	051115-20819-5	1
5/8" x 2"	For thru-feed truing and dressing of resin bond centerless wheels	051115-20820-1	1

3M™ Holding Blocks

- Used to mount 3M™ DSD Truing Tools for truing resin bond diamond and CBN wheels



2-Day Shipping
on stock wheels
within the U.S.!

Size	Application	UPC	Min./Case
For 1/4" or 3/8" diameter tools	Standard-Duty	051115-20821-8	1
For 3/8" or 1/2" diameter tools	Heavy-Duty	051115-20822-5	1

3M™ Dressing Sticks

- The most common means of dressing superabrasive wheels
- Made of aluminum oxide or silicon carbide in popular sizes



Dimensions D x T x AH	Grade	Prod ID	UPC	Min./Case
Aluminum Oxide				
1/2" x 1/2" x 4"	A0500	200TK	051141-54914-9	1
	A0220	200TH	051115-20807-2	1
3/4" x 3/4" x 4"	A0150	200TG	051115-20808-9	1
	A0500	200TK	051141-54915-6	1
1" x 1" x 6"	A0220	200TH	051115-20809-6	1
Silicon Carbide				
1/2" x 1/2" x 3"	SC320	200TI	051141-54913-2	1

3M™ Single-Point Dressing Tool — Standard

- A standard-quality natural diamond tip set in a steel shank
- Non-resettable, general purpose dresser



Shank D x L	Carat Weight	Type	UPC	Min./Case
Standard Grade Diamond Abrasive; 45° Angle				
3/8" x 2"	.25 ct	TR2S6	051115-20793-8	1
	.33 ct	TR3S6	051115-20795-2	1
	.50 ct	TR5S6	051115-20797-6	1
	.75 ct	TR7S6	051115-20799-0	1
	1.00 ct	TR10S6	051115-20801-0	1
	7/16" x 2"	.25 ct	TR2S7	051115-20794-5
.33 ct		TR3S7	051115-20796-9	1
.50 ct		TR5S7	051115-20798-3	1
.75 ct		TR7S7	051115-20800-3	1
1.00 ct		TR10S7	051115-20802-7	1



3M™ Single-Point Dressing Tool — Premium

- A premium-quality natural diamond tip set in a steel shank
- Non-resettable tool is more durable than the standard-quality version
- Used on ceramic grain wheels and other difficult-to-dress wheels



Shank D x L	Carat Weight	Type	UPC	Min./Case
Premium Grade Diamond Abrasive; 45° Angle				
3/8" x 2"	.33 ct	TR3P6	051115-20803-4	1
	.50 ct	TR5P6	051115-20805-8	1
7/16" x 2"	.33 ct	TR3P7	051115-20804-1	1
	.50 ct	TR5P7	051115-20806-5	1



3M™ Truing and Dressing Products

3M™ Multi-Point Diamond Dresser

- Contains whole natural diamonds
- Used in severe dressing applications for heavy stock removal
- For straight dressing where single-point tools are not economical



Head Diameter	Carat Weight	Description	UPC	Min./Case
Type Jr.				
1/2"	3 ct	Used on 7" and 8" wheels	051115-28466-3	1
Type 2 and 8				
5/8"	6 ct	Used on a #2 Cincinnati centerless, using an 8" wheel	051115-28465-6	1
Type CC				
1"	6 ct	Used on centerless, cylindrical, and surface grinders, using wheels 10" in diameter or larger	051115-28464-9	1

3M™ Multi-Point Dressing Tool

- Five or seven high-quality diamonds configured in a single layer; metal bond matrix
- For dressing applications requiring the highest removal rates



Shank D x L	Type	UPC	Min./Case
7/16" x 1"	 CL5S1	051141-20788-4	1
	 CL7S1	051141-20789-1	1

3M™ Impregnated Grit Dressing Tool

- Durable diamond grit in a metal bond matrix in straight or offset configurations
- Designed for common dressing applications



Size	Type	UPC	Min./Case
15° Angle			
1/2" x 1/4" x 3/8" (7/16" Shank Dia.)	2A6E7	051141-20781-5	1
15° Angle			
3/4" x 1/4" x 5/16" (7/16" Shank Dia.)	1A6C7	051141-20783-9	1
Straight			
1/2" x 1/4" x 3/8" (7/16" Shank Dia.)	2A6D7	051141-20782-2	1
Straight			
3/4" x 1/4" x 5/16" (7/16" Shank Dia.)	1A6A7	051141-20784-6	1
Cylindrical, Straight Round			
1/4" x 3/8" (7/16" x 1-1/2" Shank)	1R6J7	051141-20786-0	1
Cylindrical, Straight Round			
3/8" x 1/2" (7/16" x 1-1/2" Shank)	2R6K7	051141-20787-7	1

Adhesives Selection Guide

Metal to:	Structural Adhesives: Each adhesive has high cohesive strength to bond high strength materials and potentially replace mechanical fasteners.		Non-Structural Adhesives	
	3M™ Scotch-Weld™ Epoxy, Acrylic Adhesives	3M™ Scotch-Weld™ Instant Adhesives	3M™ Scotch-Weld™ Adhesives	3M™ Aerosol Adhesives
Metal	Acrylics, Epoxies	CA40H	1357, 1099 (All), 1300	80, 90
EPDM Rubber	—	CA40H	4799	—
Rubber (except EPDM)	Flexible 2-part Epoxies	CA40H	1300, 847	80, 90*
Glass and Ceramics	Flexible 2-part Epoxies	—	1357	80, 90
Leather	Flexible 2-part Epoxies	—	847	80
Plastics (Polyolefins)	DP8005	—	—	90
Plastics (ABS, PVC, Acrylic, etc.)	DP8005	CA40H	1357	77, 80, 90
Plastics (High Performance Nylon)	DP460	CA40H	1099 (All)	77, 80, 90
Plastics (Flexible Vinyl)	Flexible 2-part Epoxies	CA40H	1099 (All)	80
Paper and Cardboard	2-part Epoxies	—	10	77
Fabric, Felt, Cork and Fibrous Glass	2-part Epoxies	—	—	74, 77, 80, 90
Flexible Foam (Latex, Urethane)	—	—	—	74, 90
Rigid Foam (Beadboard, Styrene)	Flexible 2-part Epoxies	—	—	—
Rigid Foam (Urethane)	Flexible 2-part Epoxies	CA40H	1357, 5, 10	74, 80

Note: The technical information and data on these pages should be considered representative or typical only and should not be used for specification purposes. Final product selection should be made only after consideration of a variety of factors and evaluations of sample bonds.





*Produces a temporary bond on these materials. (1) Adhesives must be force dried and bonded while warm. (2) For best results, preheat the substrate to a minimum of 120°F (49°C). (3) Evaluate usage surface activator.



Non-Structural Adhesives

3M™ Aerosol Adhesives

Only a finger's touch puts a job-matched formulation to work on paper, plastic, cardboard, foam, metal and more. 3M Aerosol Adhesives contain no methylene chloride, chlorofluorocarbons (CFCs), or 1,1,1-trichloroethane (methyl chloroform) and are California compliant.

Product Number/Description	Spray Width	Bonding Range Surfaces One/Both	(PSI) Shear ¹ Initial/Ultimate	Relative Adhesion		Coverage Sq. Ft./Container ⁴ (Typical)	Color	Size	UPC (021200-)	Qty./Case
				Peel Strength (PIW) ²	Temperature Resistant ³					
3M™ FoamFast 74 Spray Adhesive										
 <ul style="list-style-type: none"> Fast tack with foam-tearing strength Soft, non-dimpling glue line General upholstery foam bonding Knife edge bonding, boxing, edge turning Bonds flexible urethane or latex foam together or to wood, metal and plastic 	1" – 4" variable	N/R/ 15 min.	40/205	20	120°F (49°C)	260	Inverted Orange	24 fl. oz. can	07277-6	12
							Clear	24 fl. oz. can	50045-9	12
							Original Formula Orange	24 fl. oz. can	96316-2*	12
3M™ Super 77™ Multipurpose Spray Adhesive										
 <ul style="list-style-type: none"> Fast, aggressive tack for bonding many lightweight materials High coverage Low soak-in for long lasting bonds Bonds gaskets in water pumps, and attaches insulation to sheet metal 	1-1/2"– 4" fan	15 min./ 30 min.	25/160	15	110°F (43°C)	220	Original Formula	24 fl. oz. can	96315-5*	12
							Low Mist	24 fl. oz. can	21210-9	12
3M™ Rubber & Vinyl 80 Spray Adhesive										
 <ul style="list-style-type: none"> Neoprene-based contact adhesive with plasticizer resistance Adheres stainless steel panels, stiffeners, metal kick plates, leather and most supported vinyl, plastics, laminates, wood products and rubbers (except EPDM) 	3"	N/R/ 1 hr.	50/400	35	200°F (93°C)	75/304	—	24 fl. oz. can	82618-4	6
3M™ Hi-Strength 90 Spray Adhesive										
 <ul style="list-style-type: none"> High contact bond for decorative laminate Adheres to polyethylene and polypropylene to wood, metal and more One minute dry time 	1" – 4" variable	N/R/ 15 min.	45/230	25	160°F (71°C)	100	—	24 fl. oz. can	07278-3	12

1 ATD T.M. C-700: 1/8" birch veneer bonded to 1/8" birch veneer

2 ATD T.M. C-449

3 ATD T.M. C-483: 500 g load for 1 hr. at noted temperature

4 Plastic laminate bonding @ 3-5 g/sq. ft. coverage

5 Coverage based on container sizes 24 fluid ounce or 16 fluid ounce size cans

N/R = Not Recommended







* NOT FOR SALE IN CALIFORNIA



Note: The technical information and data on these pages should be considered representative or typical only and should not be used for specification purposes.

3M™ Scotch-Weld™ Plastic Adhesives, Rubber and Gasket Adhesives and Industrial Adhesive

The Scotch-Weld™ Adhesive is a tool designed adhesive designed to provide innovative answers to a wide variety of non-structural bonding problems.

Product Number/Description	Solids Weight (Approx.)	Flash Point (Closed Cup)	Consistency	Color Dry Film	Application Method	Bonding Range	Overlap Shear Strength (PSI)		Peel Strength (PSI)	Size	UPC (021200-)	Qty./Case
							75°F (24°C)	180°F (82°C)	75°F (24°C)			
3M™ Scotch-Weld™ Nitrile High Performance Plastic Adhesive 1099												
	<ul style="list-style-type: none"> • Fast drying and heat curable • Resists weathering, water, oil, plasticizer migration, aliphatic fuels • Meets MIL-A-13883B, Type 1 and MMM-A-189C, Class 2 • A very strong plastic adhesive • Bonds most plastic and vinyl 											
	32%	0°F (-18°C)	Medium Liquid	Light Tan	Brush, Flow	Up to 40 min.	13061,2	6431,2	313	5 oz. tube	19808-3	36
3M™ Scotch-Weld™ Nitrile High Performance Plastic Adhesive 1099L												
	<ul style="list-style-type: none"> • Lower viscosity • Sprayable version of 1099 Adhesive 											
	24%	0°F (-18°C)	Thin Liquid	Tan	Spray, Brush	Up to 20 min.	13061,2	6431,2	313	5 gal. pail	22578-9	1
3M™ Scotch-Weld™ Nitrile High Performance Industrial Plastic Adhesive 4693H												
	<ul style="list-style-type: none"> • Clear, elastomeric adhesive • Exceptional adhesion to metal and plastic • Unique in its ability to bond hard-to-hold materials like polypropylene, polyethylene and high impact polystyrene 											
	36%	1°F (-17°C)	Medium Liquid	Clear	Flow, Brush	Up to 60 min.	—	—	223	5 oz. tube	30088-2	36
3M™ Scotch-Weld™ Nitrile High Performance Rubber and Gasket Adhesive 847												
	<ul style="list-style-type: none"> • Quick drying and flexible with fuel and oil resistance • Heat and solvent reactivatable • Curable with heat 											
	36%	0°F (-18°C)	Medium Liquid	Brown	Flow, Brush	Up to 15 min.	2004	94	403	5 oz. tube 1 qt.	19718-5 19721-5	36 12
3M™ Scotch-Weld™ Neoprene High Performance Rubber and Gasket Adhesive 1300												
	<ul style="list-style-type: none"> • High immediate strength • Fast-drying and heat resistant for rubber and metal 											
	37%	-14°F (-26°C)	Medium Liquid	Yellow	Flow, Brush	Up to 12 min.	5491	1364	523	5 oz. tube	19868-7	36
3M™ Scotch-Weld™ Industrial Adhesive 4799												
	<ul style="list-style-type: none"> • Brushable paste consistency with low soak-in on porous surfaces • Can bond EPDM rubber 											
	36%	-14°F (-26°C)	Thin Paste	Black	Brush, Trowel	Up to 15 min.	—	—	283	5 oz. tube	21354-0	36

1 Aluminum to aluminum @ 0.1 inches/minute
 2 Bonds heat cured for 15 minutes @ 324°F (162°C), 150 PSI
 3 Canvas to cold rolled steel @ 2.0 inches/minute separation rate
 4 Birch plywood to birch plywood @ 0.1 inches/minute separation rate

Non-Structural Adhesives

3M™ Scotch-Weld™ Neoprene Contact Adhesives

This line offers a wide range of choices for contact adhesives applications. Select from bonding ranges, strengths, solids contents and solvent formulations to meet requirements for bonding laminate, foam and more.



Product Number/ Description	Solids Weight (Approx.)	Flash Point (Closed Cup)	Consis- tency	Color Dry Film	Appli- cation Method	Bonding Range	Overlap Shear Strength (PSI)		Peel Strength (PSI)	Color	Size	UPC (021200-)	Qty./Case	
							75°F (24°C)	180°F (82°C)	75°F (24°C)					
3M™ Scotch-Weld™ Neoprene Contact Adhesive 5														
<ul style="list-style-type: none"> • Rapid strength buildup • Heat and creep resistant bond • Bonds many high pressure plastic laminates to metal and other surfaces 	19%	-14°F (-26°C)	Thin Liquid	Green, Light Yellow	Spray	30 min. max.	482 ¹	65 ¹	19 ²	Green	5 Gal. Pail	21232-1	1	
										Light Yellow	5 Gal. Pail	20333-6	1	
3M™ Scotch-Weld™ Neoprene Contact Adhesive 10														
<ul style="list-style-type: none"> • Similar performance to Contact Adhesive 5 • Brushable with higher coverage • Bonds aluminum, steel, rubber and other porous and non-porous materials to each other or to themselves 	22%	-14°F (-26°C)	Thin Liquid	Light Yellow	Brush, Roller	30 min. max.	482 ¹	65 ¹	19 ²	Light Yellow	1 Quart	20272-8	12	
											1 Gal.	20274-2	4	
											5 Gal. Pail	20276-6	1	
3M™ Scotch-Weld™ Neoprene High Performance Contact Adhesive 1357														
<ul style="list-style-type: none"> • Rapid buildup to a very high strength bond for metal • Resists heat and continuous load stress • Adheres well to metal, rubber, wood and glass 	25%	-14°F (-26°C)	Thin Liquid	Gray-green, Light Yellow	Brush, Spray	30 min. max.	536 ¹	199 ¹	42 ²	Gray Green	5 oz. tube	19887-8	36	
											1 Pint	19890-8	12	
											1 Quart	19892-2	12	
											1 Gal.	19894-6	4	
											5 Gal. Pail	19897-7	1	
											Light Yellow	1 Gal.	22586-4	4
												5 Gal. Pail	64963-9	1

1 Birch plywood to birch plywood @ 0.1 inches/minute separation rate





2 Canvas to cold rolled steel @ 2.0 inches/minute separation rate

Note: The technical information and data on these pages should be considered representative or typical only and should not be used for specification purposes.

3M™ Sealants

Help keep air, dirt, fuel, cold, heat or other elements in or out, you'll find formulations from acrylic to polyurethane.







Product Number/Description	Solids Weight (Approx.)	Flash Point (Closed Cup)	Consistency	Color (Dry)	Application Method	Cure or Dry Time	Service Temperature Range	Size	UPC (02100-)	Qty./Case
3M™ Polyurethane Sealant 540										
	<ul style="list-style-type: none"> • Polyurethane • One-component • Moisture cures rapidly to flexible seal/bond for many plastics, metal, wood and more • 250 psi tensile strength 									
	90%	136°F (58°C)	Mastic	Gray	Hand or Pressure Caulk	24 hours (3/16" dia. bead)	-40° to 194°F (-40° to 90°C)	10.5 oz. cartridge	41594-4	12
								400ml sausage pack	96277-6	12
3M™ Polyurethane Adhesive Sealant 560										
	<ul style="list-style-type: none"> • Similar to 540 but with 580 psi tensile strength • May replace mechanical fasteners • Polyurethane • One-component • Moisture cures rapidly to flexible seal/bond for many plastics, metal, wood and more 									
	90%	136°F (58°C)	Mastic	Gray	Hand or Pressure Caulk	24 hours (3/16" dia. bead)	-40° to 194°F (-40° to 90°C)	1/10 gallon cartridge	41596-8	12
3M™ Scotch-Seal™ Tamper Proof Sealant 1252										
	<ul style="list-style-type: none"> • Fire retardant seal • Resists oil, gasoline, water, jet fuel and fungus • Will not corrode metal • Tack-free in 20 seconds 									
	70%	20°F (-7°C)	Thin Paste	White	Pressure-Flow Gun	24 hours (1/8" dia. bead)	-20° to 250°F (-29° to 121°C)	5 oz. tube	20193-6	36
3M™ Scotch-Seal™ Metal Sealant 2084										
	<ul style="list-style-type: none"> • Seals metal to glass in windows and doors • Resists weather, water, oil and gasoline 									
	46%	0°F (-18°C)	Heavy Liquid	Aluminum	Brush or Flow	24 hours (1/8" dia. bead)	-30° to 250°F (-34° to 121°C)	5 oz. tube	20227-8	36

Note: The technical information and data on these pages should be considered representative or typical only and should not be used for specification purposes.

Structural Adhesives

3M™ Scotch-Weld™ Epoxy and Acrylic Adhesives

Used as an alternative for mechanical or fusion fastening due to its greater design latitude, cleaner lines, lighter weight, greater durability, less machining and often less cost.

Product Number/Color/Description	Mix Ratio (Vol) B:A	Approx. ² Viscosity 75°F (24°C) (CPS)	Approx. ³ Worklife at 75°F (24°C)	Ave. T-Peel ⁴ at 75°F (24°C) (PIW)	Overlap Shear Strength ⁵ (PSI)			Size	UPC (021200-)	Qty./Case
					-67°F (-55°C)	75°F (24°C)	180°F (82°C)			
3M™ Scotch-Weld™ Epoxy Adhesive DP100 Clear										
			<ul style="list-style-type: none"> Fast cure rigid epoxy 15–20 minute handling strength Transparent when cured 							
	1:1	13,000	4 min.	2	900	1500	300	1.7 fl. oz	22648-9	12
3M™ Scotch-Weld™ Epoxy Adhesive DP100 Plus										
			<ul style="list-style-type: none"> Higher peel and shear strength version of 178-100 							
	1:1	8,500	4 min.	10	3000	3500	200	1.7 fl. oz.	87195-5	12
3M™ Scotch-Weld™ Epoxy Adhesive DP420 Off-White										
			<ul style="list-style-type: none"> Medium worklife, toughened epoxy 1–2 hours handling strength Tough, durable structural bonds Very high performance, two-part epoxy adhesive Great for bonding metal, plastic and wood 							
	2:1	30,000	15 min.	50	4500	4500	1260	1.2 fl. oz.	82236-0	12
3M™ Scotch-Weld™ Epoxy Adhesive 2216 B/A Gray										
			<ul style="list-style-type: none"> Long worklife flexible epoxy 8–12 hrs. handling strength Bonds plastic, metal and other dissimilar materials 							
	2:3	80,000	90 min.	25	2000	2500	400	Quart Kit	20356-5	6
3M™ Scotch-Weld™ Epoxy DP460 Off-White										
			<ul style="list-style-type: none"> Long worklife toughened epoxy 2–4 hours handling strength Very high performance epoxy adhesive Great for bonding a wide variety of materials with outstanding reliability and durability 							
	2:1	30,000	60 min.	60	4500	4500	700	1.25 fl. oz.	82225-4	12

1 Color is mixed if two-part product

2 Brookfield viscometer viscosity values are typical values for the mixed product







3 The time during which an adhesive will adequately wet-out on a substrate

4 180° peel tested on .030" aluminum per ASTM D 1876-61T

5 Tested per ASTM D 1002-64

Note: The technical information and data on these pages should be considered representative or typical only and should not be used for specification purposes.

Structural Adhesives

Product Number/Color/Description	Mix Ratio (Vol) B:A	Approx. ² Viscosity 75°F (24°C) (CPS)	Approx. ³ Worklife at 75°F (24°C)	Ave. T-Peel ⁴ at 75°F (24°C) (PIW)	Overlap Shear Strength ⁵ (PSI)			Size	UPC (021200-)	Qty./ Case
					-67°F (-55°C)	75°F (24°C)	180°F (82°C)			
3M™ Scotch-Weld™ Low Odor Acrylic Adhesive DP810										
	<ul style="list-style-type: none"> Acrylic bonds many metals and plastics without surface prep Fast strength buildup Fully cured in 8 hours Low odor High peel and shear strength on slightly oily steel, aluminum, glass and painted surfaces 									
	1:1	18,000 – 30,000	8–10 min.	30	1200	3600	500	1.7 fl. oz.	49077-4 (Black)	12
								31310-3 (Tan)	12	
3M™ Scotch-Weld™ Low Odor Acrylic Adhesive DP810NS Clear										
	<ul style="list-style-type: none"> Non-sag version of DP810 10-15 minute handling strength 									
	1:1	90,000 – 95,000	8–10 min.	20	1200	4000	500	1.7 fl. oz.	49082-8	12
3M™ Scotch-Weld™ Structural Plastic Adhesive DP8005										
	<ul style="list-style-type: none"> 2-part acrylic adhesive bonds to polyethylene and polypropylene with no surface preparation Tough bond strength to resist vibration and impact Bonds most difficult-to-bond LSE (low surface energy) plastics 									
	10:1	27,500	2.5–3 min.	16	—	2000	300	35mL	41547-0 (Translucent)	12
								45167-6 (Black)	12	
3M™ Scotch-Weld™ Low Odor Acrylic Adhesive DP8810NS Green										
	<ul style="list-style-type: none"> 10 minute work life Low odor Fast rate of strength build up 									
	10:1	80,000	10 min.	20 min.	3,600	800	30 piw	45mL	68960-4	12
							490mL	68962-8	6	
3M™ Scotch-Weld™ Low Odor Acrylic Adhesive DP8805NS Green										
	<ul style="list-style-type: none"> 5 minute work life Low odor Fast rate of strength build-up 									
	10:1	80,000	5 min.	10 min.	3,600	900	30 piw	45mL	68958-1	12
							490mL	68959-8	6	
3M™ Scotch-Weld™ Acrylic Adhesive DP8405NS Green										
	<ul style="list-style-type: none"> 5 minute work life High impact resistance Minimal surface prep 									
	10:1	70,000	5 min.	15 min.	4,100	900	50 piw	45mL	68963-5	12
							490mL	68964-2	6	

1 Color is mixed if two-part product

2 Brookfield viscometer viscosity values are typical values for the mixed product

3 The time during which an adhesive will adequately wet-out on a substrate

4 180° peel tested on .030" aluminum per ASTM D 1876-61T

5 Tested per ASTM D 1002-64

Structural Adhesives

3M™ EPX™ Applicators and Accessories

Mixing nozzle will perform to your requirements. With consistent air pressure for easy uniform application, the Duo-Pak cartridge will give you the flow rate needed. Fast, convenient way to simultaneously meter, mix and apply two-part adhesives and potting compounds. System features handy Duo-Pak Adhesive Cartridges that snap quickly into the durable, lightweight EPX applicator. A slight squeeze on the trigger advances the plunger into the cartridge. Accurate measurement and the mixing nozzle provides thorough mixing and precise placement of material. Ideal system for assembly, maintenance and in-field service.



Product Number/Description	Size	UPC	Qty./Case
3M™ EPX™ Metal Applicator #9470 with 2:1 Plunger	50mL	021200-21789-0	10
3M™ EPX™ 50mL Pneumatic Applicator with 2:1 Plunger	50mL	021200-83528-5	1
3M™ EPX™ Plus II Applicator with 2:1 and 1:1 Plunger (manual)	50mL	021200-50004-6	10
3M™ EPX™ Plus II Square Gold Mixing Nozzle	127mm	021200-97331-4	36
3M™ EPX™ Mixing Nozzle #9742 for 50ml applicator	50mL	021200-21791-3	72
3M™ EPX™ 2:1 Plunger Assembly for 50ml applicator	—	021200-82314-5	10

Instant Adhesives

Product Number/ Description	Base	Time ¹ to Handling Strength (sec.)	Viscosity (CPS)	Ave. T-Peel ² at 75°F (24°C) (PIW)	Overlap Shear Strength ³ at 75°F (24°C) (PSI)						Size	UPC (021200-)	Qty./ Case
					Steel	Alumi- num	Nitrile Rubber	Neoprene Rubber	APS	Rigid PVC			
3M™ Scotch-Weld™ Instant Adhesive CA40H													
													
	Ethyl	5–40	400–600	1–2	1500	1500	35*	55*	900*	1000*	1 oz.	21073-0	12

¹ The time it takes assembled parts to reach a strength where further handling and processing can take place. Times will depend on surface to be bonded, temperature and humidity.



² Tested per ASTM D1876-61T

³ Tested per ASTM D1002-64

* Substrate Failure

Product Number/ Description	Typical Use	Color	Typical Viscosity (CPS)	Temp. Range (°F)	Time to Handling (sec.)	Full Cure (hrs.)	Bottle Size	UPC	Qty./ Case
3M™ Scotch-Weld™ Metal Instant Adhesive MC100									
									
	Low viscosity metal bonder	Clear	80–120	-65° to 180°	5–20	24	1 oz.	051111-91663-6	10
							1 lb.	048011-62634-5	1

Note: The technical information and data on these pages should be considered representative or typical only and should not be used for specification purposes.

Description	Product Number	Typical Use	Color	Typical Viscosity (CPS)	Temp. Range (°F)	Time to Handling (sec.)	Full Cure (hrs.)	Bottle Size	UPC	Qty./ Case
3M™ Scotch-Weld™ Threadlockers										
 	<ul style="list-style-type: none"> • Prevent vibration loosening • Seal against leakage and corrosion • Replaces wide variety of traditional and sometimes ineffective vibration proofing methods, reducing cost and increasing performance 									
	TL22	Screwlock—Low removal torque for small fasteners less than 1/4" (6mm) (Hand tool for removal)	Purple	1,200	-65° to 300°	<20	24	1mL	051115-31541-1	100
								10mL	048011-62601-7	10
								250mL	048011-62603-1	2
								50mL	048011-62602-4	10
	TL42	Nutlock—Medium strength, general purpose (Hand tool for removal)	Blue	1,200	-65° to 300°	<20	24	1mL	048011-62604-8	10
								10mL	048011-62605-5	10
								1L	051115-25124-5	1
								250mL	048011-62607-9	2
	TL72	High temperature studlock with gap filling for larger diameter coarse threaded parts (Heat and hand tool for removal)	Red	7,000	-65° to 300°	<20	24	1mL	051115-25133-7	10
								10mL	051115-25136-8	1
								250mL	051115-25135-1	2
								50mL	051115-25137-5	10
	TL90	Penetrating adhesive for pre-assembled fastener and porosity sealing of welds (Heat and hand tool for removal)	Green	20	-65° to 300°	<20	24	1mL	048011-62615-4	10
								10mL	051115-25150-4	1
								250mL	048011-62617-8	2
50mL								048011-62616-1	10	

3M™ Scotch-Weld™ Retaining Compounds										
	<ul style="list-style-type: none"> • Used in the assembly of coaxial components such as bearings, gears, shafts, bushes, pulleys, cylinder liners and rotors • Increases load bearing characteristics of cylindrical joints, reducing assembly stresses, assembly costs and preventing fretting and corrosion 									
	RT09	General Purpose — For tight tolerances and press fit augmentation	Green	125	-65° to 300°	10–30	24	10mL	048011-62661-1	10
								250mL	048011-62663-5	2
								50mL	048011-62662-8	10
	RT35*	Slip Fit/Slow Cure— High strength for slip fits	Green	2,000	-65° to 300°	10–60	24	10mL	048011-62667-3	10
								250mL	048011-62669-7	2
								50mL	048011-62668-0	10
	RT40*	Pressure Fit/Hi Temperature— Secures all types and sizes of bearings, shafts and cylindrical parts	Green	600	-65° to 400°	10–15	24	250mL	051115-25735-3	2
								50mL	051115-25734-6	10

* Made to order.

Anaerobic Adhesives

Description	Product Number	Typical Use	Color	Typical Viscosity (CPS)	Temp. Range (°F)	Cured Speed Unprimed (Primed)	Cured State	Size	UPC (048011-)	Qty./Case
3M™ Scotch-Weld™ Gasket Makers										
	<ul style="list-style-type: none"> Creates formed-in-place gaskets on flanges and housing to eliminate the need for large inventories of pre-cut gaskets Will not relax or shrink Exceptional pressure and solvent resistance 									
	GM15	General purpose; flexible to withstand vibration	Purple	Paste	-65° to 300°	1–12 hrs. (15 min.–2 hrs.)	Flexible	250mL tube	62656-7	2
								300mL cart.	62657-4	10
								50mL tube	62655-0	10
	GM18	Instant low pressure seal without a primer on mating aluminum flanges	Red	Paste	-65° to 300°	4–24 hrs. (30 min.–4 hrs.)	Flexible	300gm cart.	62660-4	10
50mL tube								62658-1	10	

Product Number/Description	Typical Use	Color	Size	UPC (048011-)	Qty./Case
3M™ Scotch-Weld™ Anaerobic Activator AC649					
	<ul style="list-style-type: none"> Acetone-based primer for inactive or very cold surfaces 30 day part life for pre-application 	Green	2 fl. oz. bottle	62708-3	10
			8 fl. oz. bottle	62709-0	4
			1 gal. can	62707-6	1

Note: The technical information and data on these pages should be considered representative or typical only and should not be used for specification purposes.

3M™ Temporary Surface Protection Tapes

Selection Guide for 800 Series Tapes

Increasing Tack Level

Increasing Film Performance		Low Tack	Medium Tack	Medium High Tack	Specialty
	General Purpose, 1.5 mil film	15CV804	15CV825	15CV826	
	Industrial Polyethylene, 2 mil film	21804	21825	21826	
	Industrial Polyethylene, 3 mil film	31804	31825	31826	31829
	High Performance, 2 mil film	2A804	2A825	2A826	2A829
	Industrial Polyethylene, 4 mil film		41825	41826	
	High Performance, 2.5 mil film		25A825	25A826	25A829
	Industrial Polyethylene, 5 mil film		51825	51826	
	High Performance, 5 mil film				5A829

3M™ Temporary Surface Protection Tapes

2A804 High Performance

For very smooth, high gloss surfaces

- Glass
- High pressure laminates
- LCD screens
- Painted metal, polycarbonate or plastic
- Stainless steel #7 and #8

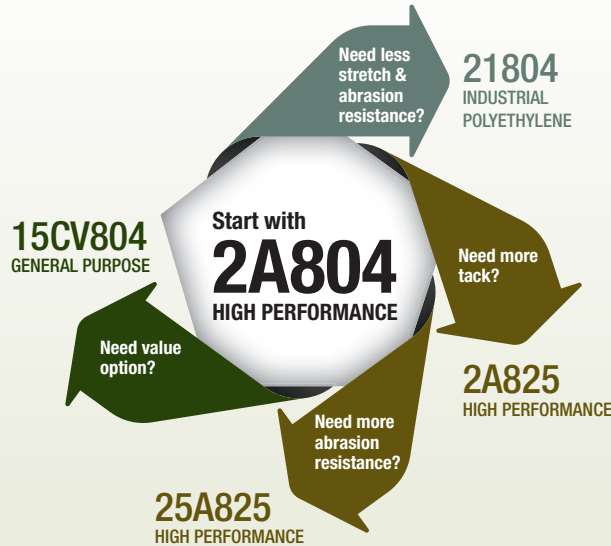

2A825 High Performance

For lightly textured or semi-gloss surfaces and/or bending, embossing, roll forming or shallow draw processes

- Anodized aluminum
- Marble
- Painted metal, high pressure laminate, plastic
- Stainless steel 2B, #3, #4

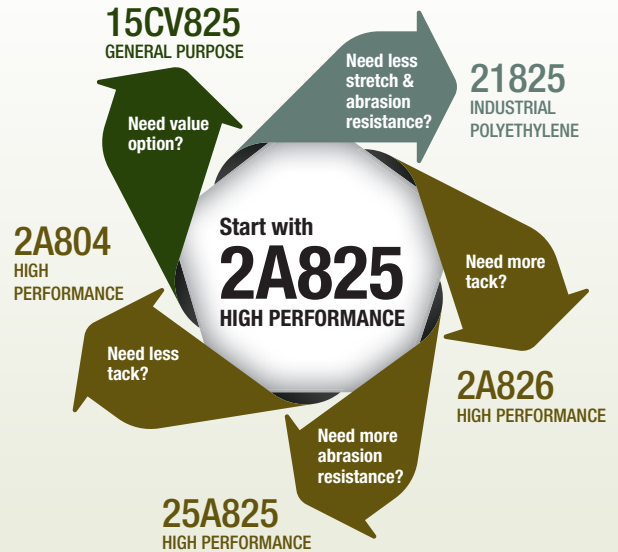

21825 High Performance

For punching, shearing or drilling processes

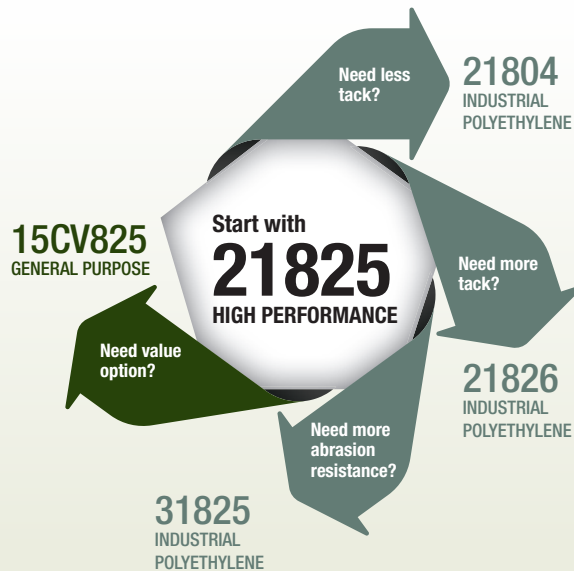

2A829 High Performance

For porous or other unique surfaces

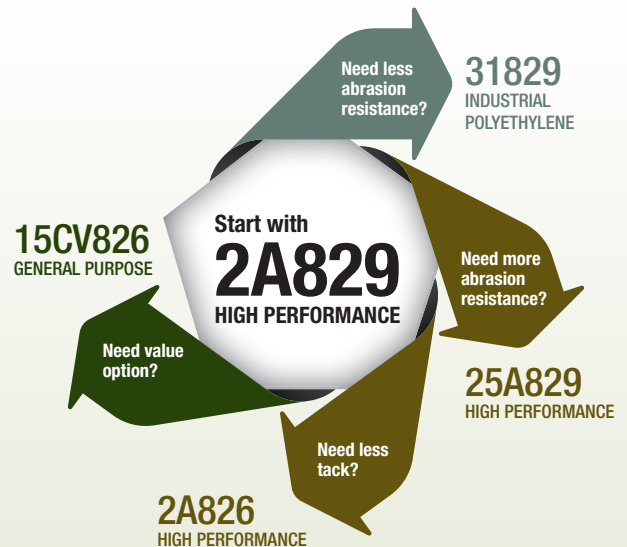

3M™ VHB™ Tapes

3M™ VHB™ Tapes are high-strength bonding tapes and a proven alternative to screws, rivets, welds and other mechanical fasteners. Unlike screws or rivets — which join materials at a single point — high-strength bonding tape permanently adheres one substrate to another while spreading the stress load across the entire length of the joint. Once materials are joined with 3M™ VHB™ Tape a virtually indestructible “weld” is created.

3M™ VHB™ Tape's all-acrylic construction seals against moisture and most solvents, providing long-term resistance to UV and temperature cycles. The tape's unique foam acts as a shock absorber for outstanding impact resistance. Unlike the stress points common to mechanical fasteners, 3M™ VHB™ Tapes distribute the stress. You can use thinner, light-weight materials with less material fatigue.



3M™ VHB™ Tapes

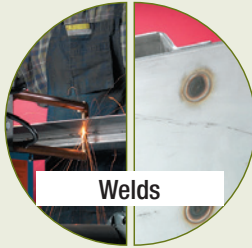

Welds

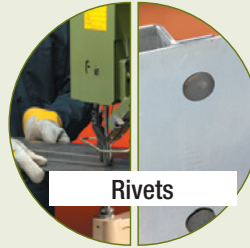

Rivets

High-Strength Bonding Tapes

Description	Product Number	Typical Use	Color	Thickness	Temperature Resistance		Size	UPC (021200-)	Qty./ Case
					Short	Long			
3M™ VHB™ Tapes									
	4941	<ul style="list-style-type: none"> Conformable and plasticizer resistant Good adhesion to metals, plastics and plasticized vinyls 	Gray	45 mils	300°F (149°C)	200°F (93°C)	1/2" x 36 yds.	64886-1	18
							3/4" x 36 yds.	64887-8	12
							1" x 36 yds.	64888-5	9
	4611	<ul style="list-style-type: none"> Bonds to bare metal and holds parts together during the washes and high temperature bake of a powder paint cycle Used for hat channel and stiffeners 	Dark Gray	45 mils	450°F (232°C)	300°F (149°C)	1/2" x 36 yds.	56375-1	18
							3/4" x 36 yds.	56002-6	12
							1" x 36 yds.	56146-7	9
	5952	<ul style="list-style-type: none"> Bonds to most liquid and powder painted surfaces, and ABS blends, without the need to prime the surface first 	Dark Gray	45 mils	300°F (149°C)	200°F (93°C)	1/2" x 36 yds.	59967-5	18
							1" x 36 yds.	56229-7	9
	4945	<ul style="list-style-type: none"> Plasticizer resistant High strength firm core Bonds to most painted substrates Good adhesion to substrates containing plasticizers 	White	45 mils	300°F (149°C)	200°F (93°C)	1/2" x 36 yds.	16961-8	18
							3/4" x 36 yds.	16954-0	12
							1" x 36 yds.	16955-7	9
	4950	<ul style="list-style-type: none"> Bonds to most metals and high surface energy substrates 	White	45 mils	300°F (149°C)	200°F (93°C)	1/2" x 36 yds.	18090-3	18
							3/4" x 36 yds.	18091-0	12
							1" x 36 yds.	18092-7	9

Note: The technical information and data on these pages should be considered representative or typical only and should not be used for specification purposes.

Masking Made Simple

Introducing 3M™ Industrial Masking Tapes. Five tapes, built on increasing levels of performance and a common goal of helping you **finish jobs worth finishing**.

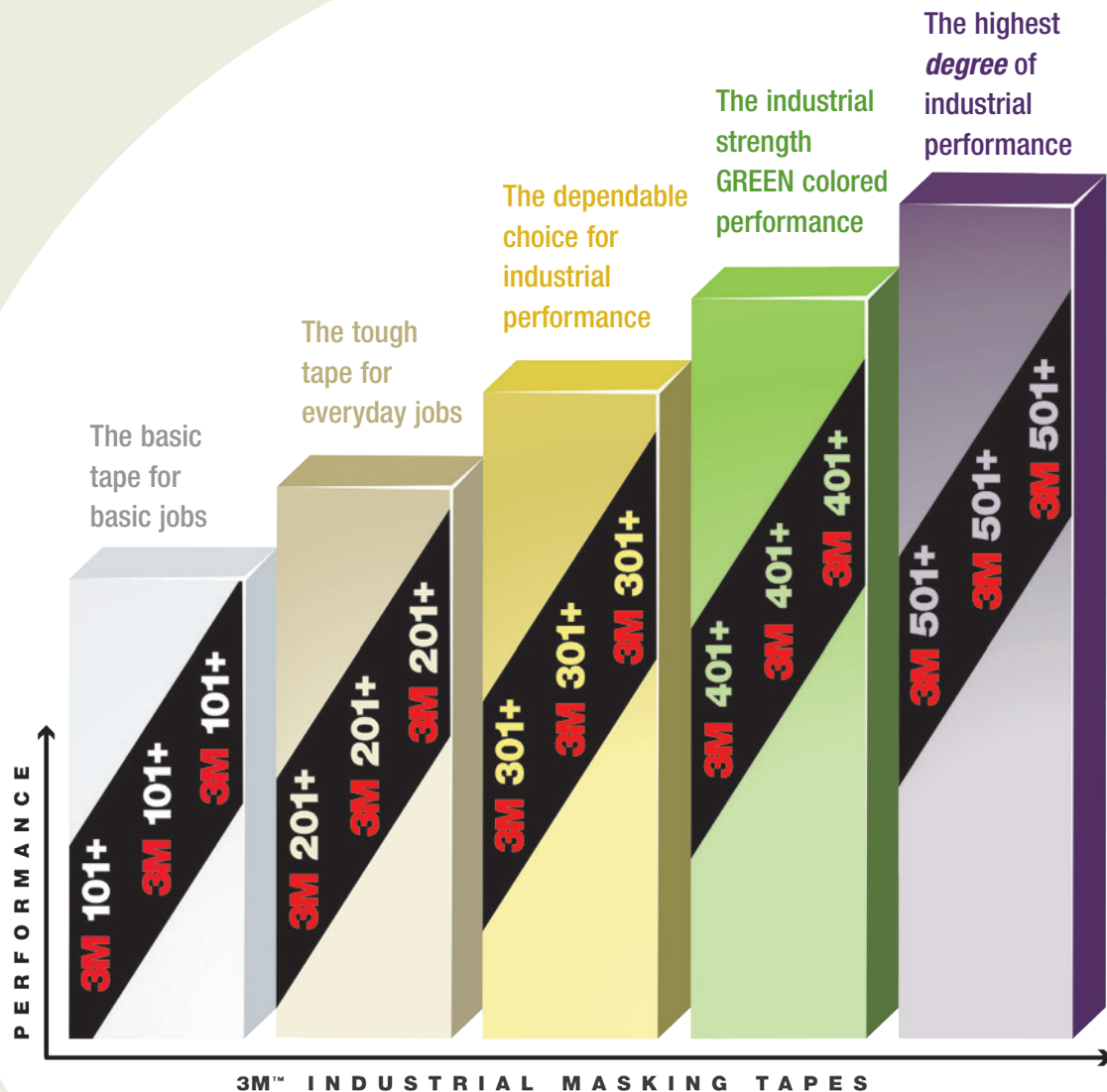



Masking Tapes

Product Number/Description	Backing/Adhesive	Total Thickness mils (mm)	Temperature Range °F (°C)	Size	UPC (051115-)	Qty./ Case
3M™ Value Masking Tape 101+						
 <ul style="list-style-type: none"> Indoor use Light-duty applications Ideal for marking, temporary holding, wrapping, and sealing 	Crepe Paper/ Rubber	5.1 (0.13)	Up to 150°F (66°C)*	18mm x 55m	68707-5	48
				24mm x 55m	68708-2	36
				36mm x 55m	68709-9	24
				48mm x 55m	68710-5	24
				72mm x 55m	67811-2	12
3M™ General Use Masking Tape 201+						
 <ul style="list-style-type: none"> Light-to-medium duty Smooth and conformable Sticks with confidence to a wide variety of surfaces Easy to handle, apply and remove in one piece Ideal for bundling, labeling and identifying 	Crepe Paper/ Rubber	4.4 (0.11)	Up to 200°F (93°C)*	18mm x 55m	64739-0	48
				24mm x 55m	64740-6	36
				36mm x 55m	64741-3	24
				48mm x 55m	64742-0	24
				72mm x 55m	64743-7	12
3M™ Performance Yellow Masking Tape 301+						
 <ul style="list-style-type: none"> Good conformability to irregular surfaces Resists paint bleed-through and offers great paint lines Yellow backing ensures good visibility Ideal for industrial paint masking, bundling, holding, marking, color coding and sealing 	Smooth Crepe Paper/Rubber	6.3 (0.16)	Up to 225°F (107°C)*	18mm x 55m	64750-5	48
				24mm x 55m	64751-2	36
				36mm x 55m	64752-9	24
				48mm x 55m	64753-6	24
				72mm x 55m	64754-3	12
3M™ High Performance Green Masking Tape 401+						
 <ul style="list-style-type: none"> Superior adhesion to metal, rubber, glass and plastic, while removing cleanly in one piece with no adhesive residue High conformable to many surfaces Resists paint bleed-through and creates super-sharp paint lines Green backing improves visibility and accuracy during paint masking Ideal for high performance industrial painting, including two-tone color applications 	Smooth Crepe Paper Treated with a Heat Resistant Saturant/ Natural Synthetic Rubber Blend	6.7 (0.17)	Up to 250°F (121°C)*	18mm x 55m	64760-4	48
				24mm x 55m	64761-1	24
				36mm x 55m	64762-8	16
				48mm x 55m	64763-5	12
				72mm x 55m	64764-2	8
3M™ Specialty High Temperature Masking Tape 501+						
 <ul style="list-style-type: none"> Exceptionally conformable to irregular surfaces Superior adhesion to metal, rubber, glass and plastic Removes cleanly in one piece with no residue Extra-strong backing resists bleed-through from most industrial paints Creates super sharp paint lines 	Smooth Crepe Paper Treated with a Heat Resistant Saturant/Rubber	7.3 (0.185)	Up to 300°F (149°C)*	18mm x 55m	64773-4	48
				24mm x 55m	64774-1	36
				36mm x 55m	64775-8	24
				48mm x 55m	64776-5	24
				72mm x 55m	64777-2	12

* Up to 30 minutes

Painting Masking Paper

Product Number/Description	Size	UPC (051131-)	Qty./Case
3M™ Scotchlok™ Masking Paper Gold			
 <ul style="list-style-type: none"> • Protects against dust contamination from its own paper fibers • Holds up well under wet sanding conditions • Excellent conformability • No solvent penetration • Bake cycles up to 225°F (107°C) for 30 minutes • Gold 	18" x 750'	06718-9	2
3M™ Masking Paper White			
 <ul style="list-style-type: none"> • For utility applications • Acceptable conformability • 24 lbs. treated paper • Bake cycles up to 400°F (204°C) for 30 minutes • White 	18" x 750'	06539-0	2

Welding Masking Paper

Product Number/Description	Size	UPC (051131-)	Qty./Case
3M™ Welding and Spark Deflection Paper			
 <ul style="list-style-type: none"> • Flame retardant • Repositionable adhesive on one side • Formulated to protect vertical surfaces, glass and paint from welding spatter and grinding sparks • Easy to use roll form 	24" x 150'	05916-0	2

High-Strength Tapes — Bundling and Reinforcing Solutions

Scotch® Filament Tapes

3M has developed a wide range of high strength tapes, resistant to abrasion, moisture and scuffing, for the bundling and reinforcing challenges faced in the industrial marketplace. Applications for these high performance products can vary dramatically — from tabbing the end lap of metal coils to stabilizing pallets to reinforcing large bulk containers or just a single carton.



These tapes balance tensile strength and adhesive holding power, even under extreme conditions, providing secure, cost-effective solutions for a variety of strapping, bundling and reinforcing applications.



Scotch® Filament Tapes Selection Guide

Application	880MSR	890MSR	898MSR	8919MSR	880	894	8919
 Coil Tabbing	●	●	●	●			●
 Pipe Bundling	●	●			●	●	

Filament Tapes

Description/ Product Number	Color	Backing	Reinforcement	Adhesive	Elongation at Break	Tensile Strength (lbs./in.)	Size	UPC (051125-)	Qty./ Case
Scotch® High Strength Filament Tape 890MSR									
	<ul style="list-style-type: none"> • Ideal for heavy gauge metals, metal bundling, coil tabbing, high strength reinforcing, lift flap closure, and heavy duty strapping • Specially formulated adhesive to provide optimum oily metal adhesion • High adhesion and long term holding power for a variety of demanding metal working applications 								
	Clear	Polyester Film	Glass Yarn	Modified Synthetic Rubber (MSR)	3%	600	18mm x 55m	74058-6	48
							24mm x 55m	74059-3	36
	UV-Resistant Black	Polyester Film	Glass Yarn	Modified Synthetic Rubber (MSR)	3%	600	18mm x 55m	74063-0	48
24mm x 55m							74064-7	36	
Scotch® Filament Tape 890MSR									
	<ul style="list-style-type: none"> • Ideal for heavy gauge metals, metal bundling, coil tabbing, high strength reinforcing, lift flap closure, and heavy duty strapping • Specially formulated adhesive to provide optimum oily metal adhesion • High adhesion and long term holding power for a variety of demanding metal working applications 								
	Clear	Polyester Film	Glass Yarn	Modified Synthetic Rubber (MSR)	3%	600	24mm x 55m	74943-5	36
							48mm x 55m	74942-8	24
Scotch® Filament Tape 880MSR									
	<ul style="list-style-type: none"> • Ideal for metal bundling, coil tabbing, high strength reinforcing, lift flap closure, and heavy duty strapping • Specially formulated adhesive to provide optimum oily metal adhesion • Best cut resistance 								
	Clear	Polyester Film	Glass Yarn	Modified Synthetic Rubber (MSR)	19%	270	18mm x 55m	74065-4	48
							24mm x 55m	74066-1	36
							48mm x 55m	74068-5	24

* 2 rolls per pack, 18 packs per case

Note: The technical information and data on these pages should be considered representative or typical only and should not be used for specification purposes.

Description/ Product Number	Color	Backing	Reinforcement	Adhesive	Elongation at Break	Tensile Strength (lbs./in.)	Size	UPC (051125-)	Qty./ Case
-----------------------------	-------	---------	---------------	----------	---------------------	-----------------------------	------	---------------	------------

Scotch® Filament Tape 898MSR



- Most versatile tape featuring MSR adhesive
- Specially formulated adhesive to provide optimum oily metal adhesion
- Good cut resistance

Clear	Polyester Film	Glass Yarn	Modified Synthetic Rubber (MSR)	3%	380	18mm x 55m	74069-2	48
						48mm x 55m	74080-7	24

Scotch® Filament Tape 8919MSR



- Thicker backing for easier dispensing and handling
- Specially formulated adhesive to provide optimum oily metal adhesion
- Long term holding power for a variety of demanding metal working applications

Clear	Polyester Film	Glass Yarn	Modified Synthetic Rubber (MSR)	3%	380	18mm x 55m	74051-7	48
						24mm x 55m	74052-4	36
						48mm x 55m	74054-8	24
						24mm x 55m	74939-8*	36
						48mm x 55m	74940-4	24

*2 rolls per pack, 18 packs per case

Description/ Product Number	Color	Backing	Reinforcement	Adhesive	Elongation at Break	Tensile Strength (lbs./in.)	Size	UPC (021200-)	Qty./ Case
-----------------------------	-------	---------	---------------	----------	---------------------	-----------------------------	------	---------------	------------

Scotch® Filament Tape 8919

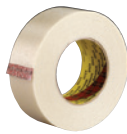

- Ideal for securing hinged appliance doors or parts during shipping and the end lap of steel or aluminum coils
- Specially formulated adhesive to provide clean removal and stain resistance on certain substrates

Clear	Scotchpar™ Film	Glass Yarn	Natural Rubber Resin	3%	380	18mm x 55m	39875-9	48
						24mm x 55m	39876-6	36
						48mm x 55m	39878-0	24

Scotch® Filament Tape 880



- High impact and cut resistance
- Long term holding power to fiberboard, non-oily metals and printed and painted surfaces

Clear	Scotchpro™ Film	Polyester yarn	Synthetic Rubber Resin	19%	270	12mm x 55m	39842-1	72
						18mm x 55m	39844-5	48



Scotch® Filament Tape 894



- General purpose packaging tape
- When used in bundling, reinforcing or coil tabbing applications with high temperatures and/or oily surfaces, tests should be conducted to determine the tape's suitability

Black	Scotchpro™ Film	Glass yarn	Synthetic Rubber Resin	4.5%	300	18mm x 55m	88131-2	48
-------	-----------------	------------	------------------------	------	-----	------------	---------	----

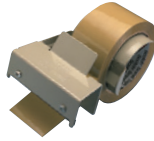
Filament Tape Dispensers

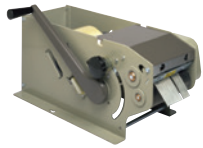
Product Number/Description	Size	UPC (021200-)	Qty./Case
Scotch® Filament Tape Dispenser H121			
 <ul style="list-style-type: none"> • Portable, lightweight, all metal hand-held dispenser • Use for a wide variety of carton reinforcing, bundling, and on-the-spot box sealing and masking applications • For Scotch® Filament Tapes up to 1" (24mm) wide on a 3" core 	1"	051111-97744-6	6
Scotch® Box Sealing Tape Dispenser H123			
 <ul style="list-style-type: none"> • Lightweight, compact, hand-held dispenser • For pressure sensitive tapes up to 72mm wide x 55m (3" wide x 60 yds.) on 3" cores • Sturdy metal construction for durable, long-life performance 	3"	11102-0	6
Scotch® Box Sealing Tape Dispenser H128			
 <ul style="list-style-type: none"> • Durable, heavy-duty metal dispenser • Provides a quick and easy method of applying H-seal and center-seam closures of RSCs • Lightweight steel construction • Adaptable for a variety of on-the-spot applications • Accommodates tapes up to 2" (48mm) wide on a 3" core 	2"	06909-3	6
Scotch® Definite Length Dispenser M82			
 <ul style="list-style-type: none"> • Heavy-duty dispenser • Handles multiple tape rolls simultaneously from 1/2" (12mm) to a maximum combined width of 4" (98mm) • Applications include definite tape lengths for box closure, holding, appliance and electronics reinforcing, strapping, or bundling, and lift-flap taping on Basilid containers 	4"	18959-3	1

Specialty Tapes

Whether you need an acid-resistant tape for plating masking, a tape that will come off cleanly after high temperature powder coating or a tape with thermal conductivity, you can find it in 3M™ Specialty Tape Solutions.

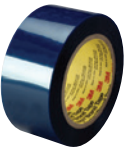
Product Number/Description	Color	Backing	Adhesive	Elongation at Break	Tensile Strength (lbs./in.)	Size	UPC (021200-)	Qty./Case	
3M™ Polyester Tapes 8901/8902									
 <ul style="list-style-type: none"> • Use as a maskant with easy removal for powder coat painting • Polyester film retains flexibility and is abrasion, chemical and thermal resistant to help reduce failures due to cracking and backing deterioration • Silicone adhesive for high heat resistance (up to 400°F; 204°C) to help reduce failure due to softening, oozing and adhesive transfer 	8901	Blue	Polyester	Silicone	115%	28	1" x 72 yds.	85764-5	36
							2" x 72 yds.	85765-2	24
	8902				130%	53	1" x 72 yds.	85766-9	36
							2" x 72 yds.	85767-6	24

Product Number/Description	Color	Backing	Adhesive	Elongation at Break	Tensile Strength (lbs./in.)	Size	UPC (021200-)	Qty./Case	
3M™ General Purpose Polyester Tape 8951/8952									
	<ul style="list-style-type: none"> • Designed to provide clean removal during hi temperature/hi pressure masking operations • Polyester film retains flexibility and thermal resistance to help reduce cracking • Abrasion, chemical and thermal resistance helps reduce backing deterioration • High heat resistant (up to 425°F; 218°C) silicone adhesive helps reduce failure due to softening, oozing and adhesive transfer 								
	8951	Blue	Polyester	Silicone	100%	30	1" x 72 yds.	48225-0	36
							2" x 72 yds.	48227-4	24
	8952				110%	55	1" x 72 yds.	48230-4	36
						2" x 72 yds.	48232-8	24	
3M™ Polyester Tape 8992									
	<ul style="list-style-type: none"> • Silicone adhesive has high temperature properties to perform powder-coat masking, flash breaker and bag seeding applications • Polyester film is solvent, heat, abrasion and shrink resistant • Green color makes tape placement obvious for both application and removal • Thin backing leaves a sharp paint line 								
	8992	Dark Green	Polyester	Silicone	83%	48	1" x 72 yds.	25736-0*	9
							2" x 72 yds.	25759-9*	6
3M™ Glass Cloth Tape 361									
	<ul style="list-style-type: none"> • For extreme temperatures • 5.4 mil backing thickness • Can withstand intermittent temperatures up to 550°F (288°C) or higher, depending upon the type and duration of the heat source 								
	361	White	Glass Cloth	Silicone	10%	182	1" x 60 yds.	03017-8	36
							2" x 60 yds.	04275-1	24
3M™ Electroplating Tape 470									
	<ul style="list-style-type: none"> • Conformable with excellent resistance to most chemicals used in typical electroplating operations • Resists most common solvents—care should be taken to avoid ketones, chlorinated hydrocarbons and esters found in lacquer thinners, degreasers, paint strippers, etc. which may cause the backing to swell or curl • Can be qualified to meet Federal Specification HH-T-0025 (GSA-FSS) 								
	470	Tan	Pigmented Vinyl Plastic	Rubber	180%	20	1" x 36 yds.	85616-7	36
							2" x 36 yds.	85617-4	24
3M™ Aluminum Foil Tape 425									
	<ul style="list-style-type: none"> • Good candidate as a maskant in electroplating of aluminum because it will not contaminate the bath • Adhesion to steel: 47 oz./in. width • An acrylic adhesive, combined with a durable aluminum backing, offers ideal properties for long serviceable life indoors and out • Aluminum backing provides excellent reflection of both heat and light 								
	425	Shiny Silver	Dead Soft Aluminum	Acrylic	8%	30	1" x 60 yds.	60572-7	36
							2" x 60 yds.	60574-1	24
3M™ Lead Foil Tape 420/421									
	<ul style="list-style-type: none"> • Very good conformability and can be die-cut into specific shapes • Adhesion to steel: 45 oz./in. width • Good thermal properties and will perform over a wide variety of temperature conditions (-60° to 225°F; -54° to 106°C); use indoors or out • Electrically and thermally conductive 								
	420	Dark Silver	Lead Foil	Rubber (Green)	12%	20	1" x 36 yds.	04923-1	9
							2" x 36 yds.	03081-9	6
	421				14%	15	1" x 36 yds.	04917-0	9
						2" x 36 yds.	03195-3	6	

*Order using prefix 051115

Scotch® Box Sealing Tapes

With Scotch® Box Sealing Tapes, you have the flexibility to seal boxes in a wide range of environments for durable and secure closure in packing stations. The tape is tough enough to resist score-line breaking and center-seam splitting, even when subject to rough handling.



Features strong backing with either pressure-sensitive hot melt synthetic rubber resin adhesive or acrylic adhesives for reliable closures. A variety of hand-held dispensers allow for quick and easy application.

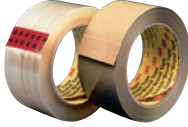
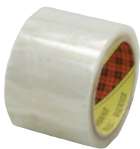

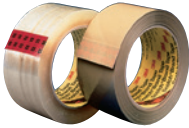
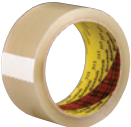

Product Number/Description	Backing/Adhesive	Total Thickness mils (mm)	Color	Size	UPC (021200-)	Qty./Case
Scotch® Box Sealing Tape 355						
 <ul style="list-style-type: none"> • Used for demanding packaging applications • Considered water resistant as per ASTM D5570 • Adheres instantly to most surfaces, including cartons containing high levels of recycled content • High edge tear and split resistance • Superior performance ensures reliable closures 	Polyester Film/ Hot Melt Rubber Resin	3.43 (.09)	Clear	48mm x 50mm	72330-8	36
				48mm x 914mm	72300-1	4
				72mm x 50mm	72331-5	24
				72mm x 914mm	72333-9	2
			Tan	48mm x 50mm	06651-9*	36
				72mm x 50mm	72327-8	24
Scotch® Box Sealing Tape 371						
 <ul style="list-style-type: none"> • Seals single wall corrugated cartons or bundles a group reliably • Polypropylene backing for tear resistance • Pressure-sensitive rubber adhesive offers quick, moisture proof seal • A good, tight, general purpose seal 	Polypropylene/ Synthetic Rubber	1.9 (.048)	Clear	48mm x 50m	13679-5	36
				72mm x 50m	19279-1	24
				48mm x 100m	15873-5	36
				48mm x 914mm	13681-8	6
				48mm x 1500mm	61823-9	6
				72mm x 100m	19280-7	24
				72mm x 914mm	18198-6	4
				72mm x 1500mm	62455-1	4
			Tan	48mm x 50m	14105-8	36
				72mm x 50m	18197-9	24
				48mm x 100m	15872-8	36
				48mm x 914mm	14107-2	6
				72mm x 100m	61525-2	24
				Scotch® Box Sealing Tape 373		
 <ul style="list-style-type: none"> • High performance, ideal for shipping heavy packages and double walled boxes • Sturdy polypropylene backing with synthetic rubber adhesive resists abrasions, moisture and scuffing for lasting hold • 1.6 mil backing and 2.5 mil total thickness for heavy-duty packaging applications • Conformable backing flexes under stress 	Polypropylene/ Synthetic Rubber	2.5 (.064)	Clear	48mm x 50m	72368-1	36
				48mm x 914mm	72377-3	6
				48mm x 1500mm	72379-7	3
				72mm x 50m	69605-3	24
				48mm x 100m	73079-5	36
				72mm x 100m	73080-1	24
			Tan	72mm x 914mm	72378-0	4
				48mm x 50m	72359-9	36
				72mm x 50m	72361-2	24
				48mm x 100m	73081-8	36
72mm x 100m	73082-5	24				

*Order using prefix 051131

Box Sealing Tapes





Product Number/Description	Backing/Adhesive	Total Thickness mils (mm)	Color	Size	UPC (021200-)	Qty./Case
Scotch® Box Sealing Tape 375						
 <ul style="list-style-type: none"> • High performance, ideal for shipping heavy packages including overpacked, double or triple-walled boxes • Sturdy polypropylene backing with synthetic rubber adhesive resists abrasions, moisture and scuffing for lasting hold • 2.0 mil backing and 3.1 mil total thickness • Conformable backing flexes under stress 	Polypropylene/Synthetic Rubber	3.1 (.079)	Clear	48mm x 50m	72406-0	36
				48mm x 914mm	72408-4	6
				72mm x 50m	72407-7	24
				72mm x 914mm	72409-1	4
				48mm x 50m	72401-5	36
				72mm x 50m	72402-2	24
Scotch® Box Sealing Tape 311						
 <ul style="list-style-type: none"> • General purpose box sealing tape designed specifically for utility type applications on light to medium weight boxes • Adheres instantly to a variety of surfaces, even in colder and damper environments • Conformable backing • Edge tear and split resistant • Good aging in sunlight or fluorescent lighting 	Polypropylene/Pressure Sensitive Acrylic	2.05 (.052)	Clear	48mm x 100mm	88292-0	36
				48mm x 1500mm	69398-4	6
				72mm x 100mm	69397-7	24
Tartan™ General Purpose Box Sealing Tape 305						
 <ul style="list-style-type: none"> • General purpose packaging tape used for non-critical box sealing applications • A conformable backing • Good closure for lightweight boxes exposed to minimal distribution hazards 	Polypropylene/Pressure Sensitive Acrylic	1.8 (.046)	Clear	48mm x 100mm	39809-4	36
				48mm x 914mm	39810-0	6
Scotch® Cold Temperature Box Sealing Tape 3331						
 <ul style="list-style-type: none"> • Ideal for applications at refrigeration temperatures or at room temperature with subsequent storage at low temperatures • Adheres to a wide variety of surfaces between 30°–40°F (-1°–4°C), secured closures maintained below 32°F (0°C) • Excellent tack at low temperatures 	Polypropylene/Pressure Sensitive Hot Melt Rubber Resin	1.8 (0.045)	Clear	48mm x 100mm	32173-3	36
				48mm x 914mm	32174-0	6
				72mm x 100mm	32175-7	24
				72mm x 914mm	32176-4	4

Box Sealing Tape Dispensers



Product Number/Description	Size	UPC (021200-)	Qty./Case
Scotch® Box Sealing Tape Dispenser H122			
 <ul style="list-style-type: none"> • Hand braking system lets you control the amount of tape you use • Popular, light, plastic, contoured hand held dispenser • Small and portable, yet allows you to dispense tape up to 2" wide on a 3" core 	48mm (2")	06925-3	6
Scotch® Low Noise Tape Dispenser H150			
 <ul style="list-style-type: none"> • Hand-held, roll-on, pistol-grip dispenser • Designed to reduce the noise of tape unwind during application • Sturdy, durable, and easy to load and operate • Metal and high-impact plastic construction • Includes "mousetrap" tape brake 	48mm (2")	39518-5	6
Scotch® Low Noise Tape Dispenser H153			
 <ul style="list-style-type: none"> • Same features as the H150 dispenser • Metal and high-impact plastic construction • Includes "mousetrap" tape brake 	72mm (3")	39820-9	6

Note: The technical information and data on these pages should be considered representative or typical only and should not be used for specification purposes.

Box Sealing Tape Dispensers

Product Number/Description		Size	UPC (021200-)	Qty./Case
Scotch® Box Sealing Tape Dispenser H180				
	<ul style="list-style-type: none"> • Hand held, portable and easy to use roll-on motion • Features an adjustable tape brake allowing control of tension and delivery • Dispenses tapes 2" wide and is constructed of plastic and metal 	48mm (2")	19008-7	6
Scotch® Box Sealing Tape Dispenser H183				
	<ul style="list-style-type: none"> • Recommended for center seam sealing of RSC boxes • Metal and high-impact plastic construction for durability and long-life performance • Hand-held dispenser features adjustable tape break 	72mm (3")	61850-5	5
Scotch® Box Sealing Tape Dispenser H192				
	<ul style="list-style-type: none"> • Tape tension can be controlled with tape roll break • High impact plastic construction 	48mm (2")	86512-1	6
Tartan™ Box Sealing Hand Dispenser HB933				
	<ul style="list-style-type: none"> • Seals cartons easily and secures a smooth, one-handed roll-on motion • Unique spring-loaded bar maintains constant tension during tape application • For tape rolls up to 3" wide on a 3" core 	72mm (3")	22922-0	6

Duct Tapes

Product Number/Description	Backing/ Adhesive	Total Thickness mils (mm)	Temperature Range °F (°C)	Color	Size	UPC	Qty./ Case
3M™ Performance Plus Duct Tape 8979							
	<ul style="list-style-type: none"> • Class 1 — Clean Removal Duct Tape • Removes cleanly from most opaque surfaces, leaving behind no sticky residue for up to six months • Indoors or outdoors, this tape stays on the job without deteriorating for up to twelve months • Water resistant and sunlight/UV resistant 	Polyethylene film over cloth scrim/Natural and Synthetic Rubber	Up to 200°F (93°C)	Slate Blue	24mm x 54.8mm	048011-53922-5	48
					48mm x 54.8mm	021200-56468-0	24
					72mm x 54.8mm	021200-56469-7	12
					96mm x 54.8mm	021200-56470-3	12
3M™ Multi-Purpose Duct Tape 3900							
	<ul style="list-style-type: none"> • Class II — Heavy Duty Duct Tape • Polyethylene coated cloth with rubber adhesive • General purpose duct tape • Good choice for general maintenance, wrapping, sealing and protecting 	Polycoated Cloth/Rubber	Up to 200°F (93°C)	Silver	48mm x 54.8mm	051131-06976-3	24
				Black	48mm x 54.8mm	021200-49833-6	24
				Yellow	48mm x 54.8mm	021200-49828-2	24
3M™ Vinyl Duct Tape 3903							
	<ul style="list-style-type: none"> • Class III — Utility Duct Tape • Embossed vinyl film coated with rubber adhesive • Designed for general sealing, color coding, masking, wrapping and bundling, protecting and other light duty applications where easy unwind, easy tear and less adhesive transfer are important 	Embossed Vinyl/Rubber	Up to 250°F (121°C)	Gray	2" x 50 yds.	051131-06984-8	24
				Black	2" x 50 yds.	051131-06995-4	24
				Yellow	2" x 50 yds.	051131-06982-4	24

* Use this prefix unless otherwise noted













Note: The technical information and data on these pages should be considered representative or typical only and should not be used for specification purposes.

3M™ Particulate Respirators

IMPORTANT: Before use of these respiratory protection products, a written respiratory protection program must be implemented, meeting all the requirements of OSHA 29 CFR 1910.134 such as training, fit testing, medical evaluation and applicable OSHA substance specific standards.







PLEASE NOTE: All products contain Advanced Electret Media, noseclip and two straps.



3M™ Particulate Respirator	Suggested Application	Nose Foam	3M™ Cool Flow™ Valve	Braided Comfort Strap	Carbon Media	Nose-clip	Welding Web	Adj. Straps	Individual Additional Features	UPC	Qty./ Case
Dusty Conditions											
	8200, N95	Grinding, Sanding, Sweeping, Other dusty operations	■			A			Patented Filter Media	051131-91913-1	160
	8210, N95	Grinding, Bagging, Sanding, Sweeping, Other dusty operations	■			A			Patented Filter Media	051138-46457-3	160
	8210 Plus, N95		■	■		A			Patented Filter Media	051138-52924-8	160
	NEW! 8210V, N95	Grinding, Bagging, Sanding, Sweeping, Other dusty operations	■	■		A			Patented Filter Media	051131-49711-0	80
	8271, P95	Grinding, Machining, Sanding, Sweeping, Other dusty/hot/oily operations		■	■	M			Patented Filter Media, Faceseal	051138-54285-1	80
	8511, N95	Grinding, Bagging, Sanding, Sweeping, Other hot/dusty operations		■	■	M			Patented Filter Media, Soft Inner Materials	051138-54343-8	80
	9105, N95	Grinding, Bagging, Sanding, Sweeping, Sawing, Other hot/dusty operations				A			Flat fold design, two sizes available, v-shaped pleats flex with mouth movement	051131-17397-7	400
	9105S, N95					A				051131-17394-6	400
	NEW! 9210+, N95	Grinding, Bagging, Sanding, Sweeping, Other hot or arid operations	■	■		A			Three-panel flat fold design, Patented Filter Media, Individual Packaging, Collapse Resistant	051131-37192-2	240
	NEW! 9211+, N95		■	■	■	A				051131-37193-9	120
Welding and Metal Pouring											
	8212, N95	Welding, Torch cutting, Brazing, Soldering, Metal pouring		■	■	A	■	■	Patented Filter Media, Faceseal, Cake Resistant Media	051138-54141-0	80
	8214, N95	Welding, Torch cutting, Brazing, Soldering, Metal pouring, Stainless, Galvanized		■	■	OV* OZ**	A	■		051138-66192-7	80









*OV: 3M recommended for relief against nuisance levels of organic vapors. Nuisance level refers to concentrations not exceeding the OSHA PEL or applicable government exposure limits, whichever is lower.
 **OZ: 3M recommended for ozone protection up to 10 times the OSHA PEL or applicable government occupational exposure limits, whichever is lower. Not NIOSH approved for use against ozone.
 M = M-noseclip A = Adjustable noseclip

3M™ Particulate Respirators

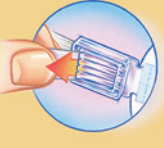
3M™ Particulate Respirator	Suggested Application	Nose Foam	3M™ Cool Flow™ Valve	Braided Comfort Strap	Carbon Media	Nose-clip	Welding Web	Adj. Straps	Individual Additional Features	UPC	Qty./Case
Welding and Metal Pouring (cont.)											
	8512, N95	Welding, Soldering and other applications where metal fumes are present including ozone** and nuisance level organic vapors*	■	■	■	A	■	■	—	051138-66298-6	80
	8514, N95	Welding, Soldering and other applications where metal fumes are present including ozone** and nuisance level organic vapors*	■	■	■	A	■	■	—	051138-66299-3	80
	8515, N95	Welding, Torch cutting, Brazing, Soldering		■		M	■		Patented Filter Media	051131-07189-1	80
Nuisance Level Odor											
	8246, R95	Aluminum, Smelting, Paper processing, Brewing operations, Glass etching, Chemical processing	■		AG [†]	A			—	051131-54357-5	120
	8247, R95	Foundry operations, Undercoating, Lab settings, Agriculture, Petrochemical processing	■		OV [*]	A			—	051131-54358-2	120
	8516, N95	Aluminum, Smelting, Paper processing, Brewing operations, Glass etching, Chemical processing		■	AG [†]	M			Softer Inner Materials	051131-66392-1	80
	8576, P95	Aluminum, Smelting, Paper processing, Brewing operations, Glass etching, Chemical processing		■	AG [†]	M			Softer Inner Materials	051131-54370-4	80
	8577, P95	Foundry operations, Undercoating, Lab settings, Agriculture, Petrochemical processing		■	OV [*]	M			Softer Inner Materials	051131-54371-1	80

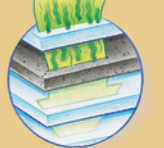
*OV: 3M recommended for relief against nuisance levels of organic vapors. Nuisance level refers to concentrations not exceeding the OSHA PEL or applicable government exposure limits, whichever is lower.
 **OZ: 3M recommended for ozone protection up to 10 times the OSHA PEL or applicable government occupational exposure limits, whichever is lower. Not NIOSH approved for use against ozone.
 M = M-noseclip A = Adjustable noseclip

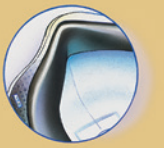
Technologies

	3M™ Cool Flow™ Exhalation Valve. Proprietary one-way valve for easy exhalation and cool, dry comfort.		Advanced Electret Media. Electrostatically charged microfibrers help make breathing easier and cooler.		Adjustable Buckle Straps. A single tug helps provide a comfortable, secure fit.
	M-noseclip. Adjusts easily for fewer pressure points and greater comfort.		Carbon Filter Material. Carbon layers remove many nuisance level odors* for greater wearer comfort.		P-series Filter. Featuring Advanced Electret Media, appropriate for prolonged use in oil and non-oil containing environments.
	Faceseal. Soft and secure, conforms closely to face for long-lasting comfort.		Cake-resistant Filter Media. Specially designed filter layers for welding provide longer respirator life and easier breathing.		Compatibility. Accommodates a wide range of safety equipment, including eye and hearing protection.

*Nuisance level odors refers to concentrations not exceeding the OSHA PEL or other applicable government exposure limits, whichever is lower.

3M™ Full and Half Facepiece Reusable Respirators

Respirator and filters provide an easy-to-use, comfortable, wide range of respiratory protection. **Applications:** Use in a variety of applications including painting, welding, metalworking and auto manufacturing (when used with appropriate cartridges, filters or supplied air).

1. Choose Facepiece

Half Facepiece

5000 Series

Features and Benefits

- Single use respirator cartridges are permanently attached
- Made from soft, lightweight thermoplastic elastomer
- No ongoing maintenance necessary
- Resealable storage bag helps keep respirator clean between uses
- Low profile design provides wider field of vision and greater comfort while wearing goggles or glasses
- For convenience and simplicity, some respirator assemblies come with 3M™ Filters P95 along with 3M™ Filter Retainers 501



6000 Series

Features and Benefits

- Made from soft, lightweight thermoplastic elastomer
- Easy to adjust head straps
- Supplied with reclosable storage bag
- Swept back design improves balance and visibility
- NIOSH approved for negative pressure air purifying and positive pressure dual airline applications
- Can be used with 3M™ Filters and Cartridges or 3M™ Dual Airline System
- Available with a standard or drop-down head harness option. Drop-down model allows wearers to lower the respirator without removing hard hat or faceshield.



7500 Series

Features and Benefits

- Made from soft, resilient silicone and heat resistant plastics
- Unique head harness design gives to the user the option of wearing the respirator in traditional or drop-down mode
- 3M™ Cool Flow™ Exhalation Valve makes breathing easier, and helps reduce heat and moisture buildup in the facepiece, and provides cool, dry comfort



Full Facepiece

6000 Series

Features and Benefits

- Soft, silicone faceseal
- Four strap suspension for easy donning and doffing
- Bayonet attachment
- Swept back cartridge design
- Wide field of vision
- Meets all the requirements of ANSI Z87.1-2003 for high impact (Z87+)
- Integrated optical correction limits distortion as you look from the left to the right
- Directs exhaled breath and moisture downward
- Smooth surface allows for quick and easy cleaning
- Available with negative pressure and dual airline models



7800S Series

Features and Benefits

- Double-flange faceseal and six adjustable straps help provide a secure fit
- Made of silicone for increased comfort and durability
- Extra-large inhalation and exhalation valves help make breathing easier
- Use with 3M™ Filters and Cartridges and/or a variety of powered and supplied air systems



FF-400 Series

Features and Benefits

- Large lens featuring Scotchgard™ Protector
- Passive speaking diaphragm
- 3M™ Cool Flow™ Valve makes breathing easier, helps reduce heat and moisture buildup in the facepiece, and provides cool, dry comfort
- Durable, long-lasting head harness and comfort cradle
- Soft, silicone nose cup and faceseal



3M™ Half Facepiece Respirator

Product	Model	Size	UPC	Qty./Case
5000 Series	51P71	S	051138-66068-5	12
5000 Series	52P71	M	051138-66069-2	12
5000 Series	53P71	L	051138-66070-8	12
6000 Series	6100	S	051131-07024-5	24
6000 Series	6200	M	051131-07025-2	24
6000 Series	6300	L	051131-07026-9	24
7500 Series	7501	S	051131-37081-9	10
7500 Series	7502	M	051131-37082-6	10
7500 Series	7503	L	051131-37083-3	10

3M™ Full Facepiece Respirator

Product	Model	Size	UPC	Qty./Case
6000 Series	6700	S	051131-54145-8	4
6000 Series	6800	M	051131-54146-5	4
6000 Series	6900	L	051131-54159-5	4
7800S Series	7800S-S	S	051138-54257-3	1
7800S Series	7800S-M	M	051138-54258-0	1
7800S Series	7800S-L	L	051138-54259-7	1
FF-400 Series	FF-401	S	051135-89418-2	4
FF-400 Series	FF-402	M	051135-89421-2	4
FF-400 Series	FF-403	L	051135-89424-3	4

Note: When used in supplier air mode, employer must provide a minimum of Grade D breathing air in accordance with OSHA requirements.

See Warning on Page 146

3M™ Particulate Filters and Gas/Vapor Cartridges

These filters and cartridges can be used interchangeably with 3M™ Reusable Respirators 6000, 7000 and FF-400 Series.

2. Choose Filter/Cartridge Combination

Particles

3M™ Particulate Filters 2000 Series



- Lightweight and easy to breathe through
- Assortment of filters available for a wide range of applications
- Easier breathing through new 3-layer advanced Electret Filter Media in 2200 Series Filters

3M™ Particulate Filter 7093, P100

- Unique, spring-loaded filter cover design simplifies negative pressure user seal checks
- Swept-back design provides enhanced field of view and greater comfort
- 7093C offers a lightweight, low profile design that combines P100 filtration with carbon-loaded features found in heavier combination cartridge products



Product Number/Description	UPC	Qty./Case
2071 Particulate Filter, P95	051138-54356-8	50
2076HF Particulate Filter, Hydrogen Fluoride/P95, with Nuisance Level Acid Gas Relief*	051138-54369-8	50
2078 Particulate Filter, P95 with Nuisance Level Organic Vapor/Acid Gas Relief*	051138-54368-1	50
2091 Particulate Filter, P100	051131-07000-9	50
2096 Particulate Filter, P100, with Nuisance Level Acid Gas Relief*	051138-54295-5	50
2097 Particulate Filter, P100, with Nuisance Level Organic Vapor Relief*	051131-07184-6	50
2291 Advanced Particulate Filter, P100	051131-17170-6	50
2296 Advanced Particulate Filter, P100, with Nuisance Level Acid Gas Relief*	051131-17171-3	50
2297 Advanced Particulate Filter, P100, with Nuisance Level Organic Vapor Relief*	051131-17172-0	50

Product Number/Description	UPC	Qty./Case
7093 Particulate Filter, P100	051131-52705-3	60
7093B Particulate Filter, P100, Bulk	051131-52706-0	144
7093C Cartridge/Filter, Hydrogen Fluoride, P100, with Nuisance Level Organic Vapor/Acid Gas Relief*	051131-37173-1	60

Filter Retainer and Filter Adapters for Particles

Adapter 502***	Retainer 501	Adapter 603
100/Case	100/Case	16/Case
051138-21511-3	051138-17668-1	051138-54376-6

***Do not reuse

Gases and Vapors

3M™ Gas/Vapor Cartridges 6000 Series



- Low-profile design helps maintain good field of vision
- Full range of cartridges to meet your needs

Product Number/Description	UPC	Qty./Case
6001 Cartridge, Organic Vapor	051138-21674-5	30 pairs
6002 Cartridge, Acid Gas**	051138-28880-3	30 pairs
6003 Cartridge, Organic Vapor/Acid Gas**	051138-07047-4	30 pairs
6004 Cartridge, Ammonia/Methylamine	051138-28882-7	30 pairs
6005 Cartridge, Formaldehyde/Organic Vapor	051138-28883-4	30 pairs
6006 Cartridge, Multi Gas/Vapor**	051138-54186-1	30 pairs
6009 Cartridge, Mercury Vapor or Chlorine	051138-29148-3	30 pairs

Filter Retainer and Filter Adapters for Particles

Adapter 502***	Retainer 501
100/Case	100/Case
051138-21511-3	051138-17668-1

***Do not reuse

Particles and Vapors

3M™ Combination Cartridges/P100 Particulate Filters 6000 Series



- Particulate filter is permanently attached to cartridge for easy, one-step assembly
- Unique design for enhanced comfort and visibility

Product Number/Description	UPC	Qty./Case
60921 Cartridge/Filter, Organic Vapor/P100	051138-46465-8	30 pairs
60922 Cartridge/Filter, Acid Gas/P100**	051138-46466-5	30 pairs
60923 Cartridge/Filter, Organic Vapor/Acid Gas/P100**	051138-46467-2	30 pairs
60924 Cartridge/Filter, Ammonia/Methylamine/P100	051138-46468-9	30 pairs
60925 Cartridge/Filter, Formaldehyde/Organic Vapor/P100	051138-46469-6	30 pairs
60926 Cartridge/Filter, Multi-Gas/Vapor/P100**	051138-54187-8	30 pairs
60928 Cartridge/Filter, Organic Vapor/Acid Gas/P100**†	051138-46470-2	30 pairs
60929 Cartridge/Filter, Mercury Vapor/Chlorine Gas/P100	051138-46471-9	30 pairs

* 3M recommended for relief against nuisance levels of organic vapors and acid gases. Nuisance level organic vapor and acid gas refers to concentrations not exceeding OSHA PEL or applicable government occupational exposure limits, whichever is lower. Do not use for respiratory protection against acid gases or organic vapors (except hydrogen fluoride).

** Reminder: These cartridges are approved for respiratory protection from hydrogen sulfide gas up to 10 times the permissible exposure limit (PEL) with half facepiece respirators and full facepiece respirators when qualitatively fit tested, or up to less than 300 parts per million (ppm) with full facepiece respirators when quantitatively fit tested or according to specific OSHA standards or applicable government regulations, whichever is lower. 300 ppm is the concentration considered Immediately Dangerous to Life or Health (IDLH) for hydrogen sulfide.

† As recommended by the California Department of Pesticide Regulation No. 01-009-Methyl Bromide Field Fumigation. 3M recommended for use against radioiodine and methylbromide. **Note:** Not NIOSH approved for methylbromide or radioiodine.

See Warning on Page 146

3M™ Speedglas™ Welding Helmets

3M™ Speedglas™ 100 Welding Helmets

- Auto-Darkening Filters (ADF) 100V, 100S-10 and 100S-11 are good for Stick, MIG and most TIG welding and offer excellent optical quality
- ADF 100V has dark shades 8–12 (shade 3 in the light state) and three user-selectable sensitivity levels for reliable arc detection
- ADFs 100S-10 and 100S-11 have shades 3 and 10 or 11 respectively
- Viewing area: 6.05 in²



Description	Product Number	Shade	UPC	Qty./Case
Black Welding Helmets				
100 Series Welding Helmet with ADF 100V	07-0012-31BL	3, 8–12	051131-49529-6	1
100 Series Welding Helmet with ADF 100S-10	07-0012-10BL	3, 10	051131-37230-6	1
100 Series Welding Helmet with ADF 100S-11	07-0012-11BL	3, 11	051131-37231-3	1
Graphic Welding Helmets				
Blazed 100 Series Welding Helmet with ADF 100V	07-0012-31BZ	3, 8–12	051131-37233-7	1
Aces High 100 Series Welding Helmet with ADF 100V	07-0012-31AH	3, 8–12	051131-37237-5	1
American Pride 100 Series Welding Helmet with ADF 100V	07-0012-31AP	3, 8–12	051131-37238-2	1
Boneyard 100 Series Welding Helmet with ADF 100V	07-0012-31BY	3, 8–12	051131-49950-8	1
Xterminator 100 Series Welding Helmet with ADF 100V	07-0012-31XT	3, 8–12	051131-49958-4	1
Tribute 100 Series Welding Helmet with ADF 100V	07-0012-31TB	3, 8–12	051141-56076-2	1
Women's Welding Helmets				
Wild-N-Pink 100 Series Welding Helmet with ADF 100V	07-0012-31WP	3, 8–12	051131-37229-0	1

3M™ Speedglas™ 9100 Welding Helmets

- Radically-new design fundamentally changes not only how the user wears the helmet, but also how the welder experiences the helmet's fit, stability and balance
- ADFs 9100V, 9100X and 9100XX have dark shades 5, 8–13 (shade 3 in the light state), sensitivity adjustment that allows use with all Stick, MIG and TIG processes, as well as grinding and torch cutting modes
- Viewing areas: 9100V = 6.05 in²; 9100X = 9.12 in²; 9100XX = 12.11 in²



Description	Product Number	Shade	UPC	Qty./Case
9100 Series Welding Helmet with ADF 9100V	06-0100-10	3, 5, 8–13	051135-89353-1	1
9100 Series Welding Helmet with Side Windows and ADF 9100V	06-0100-10SW	3, 5, 8–13	051135-89354-8	1
9100 Series Welding Helmet with ADF 9100X	06-0100-20	3, 5, 8–13	051131-37172-9	1
9100 Series Welding Helmet with Side Windows and ADF 9100X	06-0100-20SW	3, 5, 8–13	051135-89356-2	1
9100 Series Welding Helmet with ADF 9100XX	06-0100-30	3, 5, 8–13	051131-37191-0	1
9100 Series Welding Helmet with Side Windows and ADF 9100XX	06-0100-30SW	3, 5, 8–13	051135-89387-6	1

3M™ Speedglas™ Welding Helmets

3M™ Speedglas™ 9100 FX Welding Helmets

- Innovative wide-view grinding visor to give welders an all-in-one solution for more flexibility, precision, and efficiency
- Exceptionally clear, wide grinding visor offers a greater field of view in all directions, while a smooth flip-up pivot mechanism assures effortless transition from welding to grinding modes
- ADFs 9100V, 9100X and 9100XX have dark shades 5, 8–13 (shade 3 in the light state), sensitivity adjustment that allows use with all Stick, MIG and TIG processes, as well as grinding and torch cutting modes
- Viewing areas: 9100V = 6.05 in²; 9100X = 9.12 in²; 9100XX = 12.11 in²



Description	Product Number	Shade	UPC	Qty./Case
9100 FX Series Welding Helmet with Side Windows and ADF 9100V	06-0600-10SW	3, 5, 8–13	051131-49671-2	1
9100 FX Series Welding Helmet with Side Windows and ADF 9100X	06-0600-20SW	3, 5, 8–13	051131-49673-6	1
9100 FX Series Welding Helmet with Side Windows and ADF 9100XX	06-0600-30SW	3, 5, 8–13	051131-49675-0	1

3M™ Speedglas™ SL (Super Light) Welding Helmet

- Only 12.6 oz. (including filter)
- ADF has variable shades 8–12 and 4 sensitivity levels
- Head suspension increases adjustability



Description	Product Number	Shade	UPC	Qty./Case
SL Welding Helmet with ADF	05-0013-41	3, 8–12	051131-98564-3	1

3M™ Speedglas™ Auto-Darkening Filters (ADF)







	Speedglas 100	Super Light (SL)	Speedglas 9100
Viewing Area	1.73" x 3.66" (44mm x 93mm)	1.68" x 3.57" (91mm x 43mm)	9100V: 1.8" x 3.7" (44mm x 93mm) 9100X: 2.1" x 4.2" (54mm x 107mm) 9100XX: 2.8" x 4.2" (73mm x 107mm)
Dark State Options	Shades 8–12 (variable) Shade 10 or Shade 11 (single shade)	Shades 8–12 (variable)	Shades 5, 8–13 (variable)
Weight — Complete Assembly (Ounces)	15 (Black Helmet) 16 (Graphic Helmet)	13	9100V: 18.0 (18.9 w/SideWindows) 9100X: 18.3 (19.2 w/SideWindows) 9100XX: 19.2 (20.1 w/SideWindows)
Special Modes	None	Automatic on/off	Grinding, Tacking*, Lock-in Dark State
Switching Speed (Milliseconds)	0.1	< 0.15	0.1
Battery Life (Hours)	1,500	1,500	9100V: 2,800 9100X: 2,500 9100XX: 2,000
Sensitivity Modes	3 levels	4 levels	5 levels

*Patented feature — ONLY available on 3M™ Speedglas™ 9100 Series Welding Helmets

Hearing Conservation

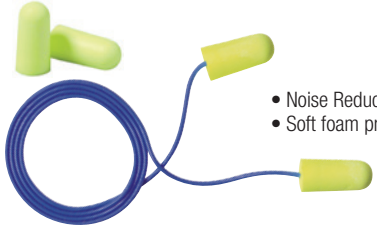
3M offers a wide variety of solutions to help reduce noise exposure. A full line of comfortable, easy-to-use hearing protectors, including earplugs, ear muffs, and banded hearing protectors are available from 3M.

Product Number/Description	Model	UPC	Qty./Case
3M™ Foam Earplug 1100 and 3M™ Corded Foam Earplug 1110			
 <ul style="list-style-type: none"> • Smooth dirt resistant surface and tapered shape fit the ear canal and provide added comfort and hygiene • Hypo-allergenic material • Each package is easy to dispense • Noise Reduction Rating: 29 dB* • Available in corded and uncorded versions 	1100 (uncorded)	051138-29008-0	1000 Pairs
	1110 (corded)	051138-29009-7	500 Pairs
3M™ Pistonz™ Earplugs P1400 and 3M™ Pistonz™ Corded Earplugs P1401			
 <ul style="list-style-type: none"> • Instant-use — No need to roll down • Stem is stiff enough for insertion, yet designed to flex sideways if impacted • Metallic-style earplug tips with ultra-soft feel for all day wear • Officially licensed hearing protection of NASCAR® • Noise Reduction Rating: 29 dB* • Available in corded and uncorded versions 	P1400 (uncorded)	93045-93401-7	400 Pairs
	P1401 (corded)	93045-93402-4	400 Pairs
3M™ E-A-R™ Classic™ Uncorded Earplugs 310-1001			
 <ul style="list-style-type: none"> • Conforms to the shape of the ear canal to help create a comfortable, snug noise barrier • Pillow pak keeps these disposable earplugs available, reusable and clean • Slow-recovery earplug foam is non-flammable and moisture resistant • Meets ANSI S3.19-1974; CSA Class AL • Noise Reduction Rating: 29 dB* 	310-1001	80529-10000-6	2000 Pairs
3M™ E-A-Rsoft™ Yellow Neons™			
 <ul style="list-style-type: none"> • Noise Reduction Rating: 33 dB* (Highest NRR available) • Soft foam provides low pressure with excellent attenuation 	312-1250 (uncorded)	80529-12063-9	2000 Pairs
	311-1250 (corded)	80529-11033-3	2000 Pairs
3M™ E-A-R™ UltraFit™			
 <ul style="list-style-type: none"> • Noise Reduction Rating: 25 dB* • Flanged design for comfortable fit • Conforms to shape of ear • Washable, promotes worker hygiene • No rolling or touching plug portion during insertion 	340-4003 (uncorded)	80529-40002-1	400 Pairs
	340-4004 (corded)	80529-40003-8	400 Pairs
	340-4002 (corded w/case)	80529-40001-4	200 Pairs



*Research suggests that many users will receive less noise reduction than indicated by the NRR due to variation in earplug fit and wearing time. It is recommended that the NRR be reduced by 50% for estimating the average amount of noise reduction provided.

Hearing Conservation

Product Number/Description	Model	UPC	Qty./Case
3M™ E-A-R™ Push-Ins™ with Grip Rings			
 <ul style="list-style-type: none"> • Shaped for comfort and gripped for fit • Noise Reduction Rating: 30 dB* • Easy fit with no roll down required • Foam softens with body heat • Grip Ring design to gently hug ear canal 	318-1008 (uncorded)	80529-18010-7	2000 Pairs
	318-1009 (corded)	80529-18011-4	2000 Pairs
3M™ E-A-R™ Push-Ins™			
 <ul style="list-style-type: none"> • Easy fit with no roll down required • Noise Reduction Rating: 28 dB* • E-A-Rform™ yellow foam tip for great comfort • Blue stem allows for hygienic insertion and removal 	318-1000 (uncorded)	80529-18017-9	400 Pairs
	318-1001 (corded)	80529-18017-9	400 Pairs
3M™ E-A-Rflex™ Banded Hearing Protector			
 <ul style="list-style-type: none"> • Noise Reduction Rating: 25 dB* • Highest NRR for a semi-insert in all three positions • Comfortable, lightweight alternative to earmuffs • Band helps prevent loss and is good for intermittent use 	350-1001 (band w/tips)	80529-50007-3	10/Box
	350-1002 (replacement tips)	80529-50008-0	5 Pair/Pack
3M™ E-A-R™ One Touch™ Base and “No Waste Funnel” with Classic™ and Yellow Neon™ Plugs Banded Hearing Protector			
 <ul style="list-style-type: none"> • “No Waste Funnel” allows users to reuse base and dispenser • One Touch™ base can be used as a table top unit or wall mounted • Easy access for the user from all sides • No waste of packaging for individual earplugs 	391-1000 (dispenser)	80529-91000-1	1/Box
	391-1001 (Classic™ replacement bottle)	80529-91001-8	2000 Pairs
	391-1004 (Yellow Neon™ replacement bottle)	80529-91004-9	2000 Pairs

*Research suggests that many users will receive less noise reduction than indicated by the NRR due to variation in earplug fit and wearing time. It is recommended that the NRR be reduced by 50% for estimating the average amount of noise reduction provided.

Hearing Conservation

Product Number/Description	Model	UPC	Qty./Case
3M™ Peltor™ Optime™ 95 Banded Hearing Protector			
 <ul style="list-style-type: none"> • Ideal against high-frequency noise with work areas including machine shops and power tools • Ultra light with liquid/foam filled ear cushions • Low profile earmuff and neckband • NRR 21 dB* 	H6A/V (Headband style)	93045-08061-5	10/Case
	H6B/V (Neckband style)	93045-08062-2	10/Case
	H6P3E/V (Helmet-attachment style)	93045-08065-3	10/Case
3M™ Peltor™ Optime™ 101 Banded Hearing Protector			
 <ul style="list-style-type: none"> • Excellent attenuation at low and high frequencies • Enables safe working environment for longer periods of time, up to 101dBA • Two low mounting points provide great comfort • H7A: NRR 27 dB* • H7B: NRR 26 dB* • H7P3E: NRR 24 dB* 	H7A (Headband style)	93045-08071-4	10/Case
	H7B (Neckband style)	93045-08072-1	10/Case
	H7P3E (Helmet-attachment style)	93045-08073-8	10/Case
3M™ Peltor™ X-Series Earmuffs NEW!			
 <ul style="list-style-type: none"> • Newly designed spacer, specially formulated foam liners and innovative ear cushions to help improve attenuation • Lightweight, lower-profile earmuffs increase compatibility with other personal protective equipment • Designed for protection against moderate-to-high level industrial noise • Replaceable ear cushions and foam liners • Earcup pivot points tilt for optimum comfort and efficiency <p>X4A</p> <ul style="list-style-type: none"> • Electrically insulated wire headband, often referred to as “dielectric” • Wire headband offers consistent pressure over prolonged wearing periods • NRR 27 dB* (CSA Class AL) <p>X4P3E</p> <ul style="list-style-type: none"> • Universal mounting attachment fits most hard hats • Stainless steel band construction resists bending and warping to offer consistent pressure over prolonged wearing periods • NRR 25 dB* (CSA Class A) 	X4A (Over-the-Head)	93045-93726-1	10/Case
	X4P3E (Cap-Attached)	93045-93731-5	10/Case

*Research suggests that many users will receive less noise reduction than indicated by the NRR due to variation in earplug fit and wearing time. It is recommended that the NRR be reduced by 50% for estimating the average amount of noise reduction provided.

3M™ Noise Indicator NI-100

Product Number/Description	Model	UPC	Qty./Case
 <ul style="list-style-type: none"> • LED light clearly indicates when noise levels exceed a potentially hazardous threshold • Helps identify areas where hearing protection may need to be worn • Clip to a shirt or jacket 	NI-100	051131-17453-5	10
	<ul style="list-style-type: none"> • Charging cord • Sold separately 	NI-CHG	051131-17475-9

3M™ Protective Eyewear

3M eye protection products help provide wearer comfort, safety and a fashionable look. They are available in several designs to meet the needs of a wide variety of people and conditions.



Product Number/Description	Model	Color	UPC	Qty./Case
3M™ SecureFit™ Protective Eyewear NEW!				
<ul style="list-style-type: none"> Stylish, lightweight design weighs less than 1oz. Proprietary 3M™ Pressure Diffusion Temple (PDT) Technology helps provide a secure, snug fit without compromising comfort Self-adjusts to fit a wide array of head sizes Anti-fog coated lenses absorbs 99.9% UV Meets the highest ultraviolet filter rating of ANSI Z87.1-2010 standard (UG) Meets the requirements of CSA Z94.3-07 and is Impact Rated to ANSI Z87.1-2010 	SF201AF	Clear Anti-Fog Lens	78371-65717-5	20/Case
	SF202AF	Gray Anti-Fog Lens	78371-65718-2	20/Case
	SF203AF	Amber Anti-Fog Lens	78371-65719-9	20/Case
3M™ Virtua™ CCS Protective Eyewear with Foam Gasket NEW!				
<ul style="list-style-type: none"> Comfortable, lightweight frame features the Cord Control System (CCS) designed to keep a corded earplug attached, untangled and ready for use Optional foam gasket attachment helps limit eye exposure to nuisance dust while providing additional cushioning Anti-fog polycarbonate lenses absorb 99.9% UV Meets the requirements of CSA Z94.3-07 and is Impact Rated to ANSI Z87.1-2010 	11872-00000-20	Clear Anti-Fog Lens	78371-11872-0	20/Case
	11873-00000-20	Gray Anti-Fog Lens	78371-11873-7	20/Case
	11874-00000-20	I/O Mir Anti-Fog Lens	78371-11874-4	20/Case
3M™ Virtua™ AP Protective Eyewear				
<ul style="list-style-type: none"> Popular unisex styling Lightweight frame—less than 1 oz. Meets ANSI Z87.1-2010 High Impact Requirements standards Contoured flexible temples for comfortable fit High-wrap lenses fit snug against the face, for wider viewing area. 	11815-00000-20	Gray Hard Coat Lens	78371-11815-7	10/Box
	11818-00000-20	Clear Anti-Fog Lens	78371-11818-8	10/Box
	11819-00000-20	Clear Hard Coat Lens	78371-11819-5	10/Box
	11847-00000-20	Indoor/Outdoor Mirror Hard Coat Lens	78371-11847-8	10/Box
3M™ Light Vision™ 2 Protective Eyewear				
<ul style="list-style-type: none"> Ultra-bright, adjustable LED lights Long-lasting batteries provide up to 50 hours of continuous use Soft nose bridge and temple tips Available in readers with three bifocal magnification strengths: +1.50, +2.00, +2.50 Polycarbonate lenses absorb 99.9% UV Meets the requirements of CSA Z94.3-2007 and the High Impact Requirements of ANSI Z87.1-2003 	11476-00000-10	Gray Frame/ Clear Anti-Fog Lens	78371-62111-4	10/Case
3M™ Lexa™ Protective Eyewear				
<ul style="list-style-type: none"> Extra wide viewing range and contoured design Lightweight, full coverage eye protection Fully customizable with multiple lens options, three lens angles and four temple lengths Meets ANSI Z87.1-2003 and CSA Z94.3-2007 	15200-00000-20	Clear Anti-Fog Lens/ Black Temple	78371-62287-6	20/Case
	15250-00000-20	MinimizeR™ Lens/ Black Temple	78371-62299-9	20/Case
3M™ BX™ Reader Protective Eyewear NEW!				
<ul style="list-style-type: none"> Sleek, contoured and fully adjustable with molded-in magnifying diopters on the upper and lower lenses (11374: +1.5 Diopter; 11375: +2.0 Diopter; 11376: +2.5 Diopter) Polycarbonate lenses absorb 99.9% UV Meets the requirements of CSA Z94.3-2007 and the High Impact Requirements of ANSI Z87.1-2003 	11374-00000-20	Silver/Black Frame/ Clear Anti-Fog Lens	78371-62046-9	20/Case
	11375-00000-20	Silver/Black Frame/ Clear Anti-Fog Lens	78371-62047-6	20/Case
	11376-00000-20	Silver/Black Frame/ Clear Anti-Fog Lens	78371-62048-3	20/Case



3M™ Sorbents

3M™ Maintenance Sorbents: Fast acting, highly absorbent, easy to use and absorb almost any type of non-aggressive liquids such as oils, coolants, hydraulic fluids and water. Its high fluid capacity means the need to change the sorbent is less frequent, saving on material, labor and disposal costs.



3M™ Petroleum Sorbents: Sorbs oil and other petroleum-based liquids while repelling water. Available in a variety of configurations to best suit your needs including folded, pads, booms, pillows, sweeps, rolls and drum covers.



3M™ Maintenance Sorbents

Product Number/Description	Model	Size	UPC	Qty./Case
Folded M-FL550DD, High Capacity				
 <ul style="list-style-type: none"> • Easy-to-use solution for cleaning up spills, drips and fluid leaks • Versatile: can be used in pillow, pad, roll or boom configuration • Scrim on one side to increase strength and help eliminate linting • Dispenses from a carrying/dispenser box in the form of a continuous roll • Less waste: perforated every 16 inches so you can select the length required • Absorbs 31.5 gallons per case • Applications range from maintenance to spill response 	M-FL550DD	5' x 50'	051138-29071-9	3
Rug M-RG36300E				
 <ul style="list-style-type: none"> • Use in areas where foot and vehicle traffic is a concern • Will sorb non aggressive liquids while enduring the punishment of being tread upon • Durable and versatile • Use in industrial maintenance applications • Absorbs 32 gallons per rug 	M-RG36300E	36" x 300'	051138-29002-3	1
Mini-Boom				
 <ul style="list-style-type: none"> • Tube-like shape is ideal for placing around machinery to contain spills and prevent leaks from spreading into adjacent work areas • 3 inch diameter scrim on the outside of the boom identifies the use while containing particulate sorbent material designed for the application • Absorbs 12 gallons per case 	M-MB304	3" x 4'	051138-21526-7	12
	M-MB308	3" x 8'	051138-21527-4	6

3M™ Petroleum Sorbents

Product Number/Description	Model	Size	UPC	Qty./Case
Pad HP-156, High Capacity				
 <ul style="list-style-type: none"> • Low-profile design can be easily placed in tight areas • Ideal for cleaning up small spills and wiping down contaminated areas • Has a scrim on one side to increase strength and help eliminate linting • Conveniently sized, allows the user to quickly spread sorbent over and in the path of a spill • Can also be used on a work surface in anticipation of a spill or as a wipe • Absorbs 37.5 gallons per bale 	HP-156	17" x 19"	051138-28911-4	100
Pad T-151				
 <ul style="list-style-type: none"> • This highly sorbent pad features a low-profile design for easy placement in tight areas • Ideal for cleaning up small spills and wiping down contaminated areas • Absorbs 43.5 gallons per bale 	T-151	17" x 19"	021200-16049-3	200

3M™ Fall Protection

The Height of Confidence — It is our mission at 3M to provide those responsible for the safety of workers at height with reliable fall arrest equipment. We offer the knowledge and support to help take the fear out of height.

Harnesses

3M™ Elavation™ Harness

- The premium 3M™ Fall Arrest Harness
- Premium padding
- Intuitive adjustment hardware
- Web designed for additional abrasion resistance
- Rubber protective shield for label pack



3M™ Ameba Harness

- Features comfort forming webbing
- Non-elastic helical yarn moves with wearers to assist comfort and mobility
- Value padding for added comfort and moisture wicking
- Laminated sleeve helps protect label



3M™ SafeLight™ Harness

- The economical choice in fall arrest harnesses
- Quality construction at a value price
- Bright color web assists worker visibility on a jobsite



Model	UPC	Qty./Case
7512E	78371-64010-8	1

Model	UPC	Qty./Case
1451Q	78371-63599-9	1

Model	UPC	Qty./Case
10950	78371-00081-0	1

Lanyards

3M™ SafeAbsorb™ Dual Leg Elast Combo Lanyard

- Stretches from 4–6 feet to help reduce trip hazards
- 310 lbs. rated
- 3,600 lbs. gate rated hardware
- Integrated shock absorber



3M™ Adjustable Lanyard w/Rebar Hooks

- Versatile offering of lengths and hardware for general use
- 310 lbs. rated
- 3,600 lbs. gate rated hardware
- Meets requirements of latest ANSI Z359.13-2009 standards
- Includes an external shock pack



3M™ SafeLight™ Lanyard

- The economical choice in fall arrest lanyards
- 310 lbs. rated
- 3,600 lbs. gate rated hardware
- Meets requirements of ANSI Z359.1-2007 standards
- Available in low-profile or external shock pack designs



Model	UPC	Qty./Case
4750/0241	78371-01437-4	1

Model	UPC	Qty./Case
3251D-0241	78371-00254-8	1

Model	UPC	Qty./Case
209512	78371-00103-9	1

Self-Retracting Lanyards

3M™ ReLoad™ Retractable Lifeline

- Can be inspected and serviced on-site by authorized technicians for lower maintenance costs
- Clicking sound provides audible indication that pawls are functioning correctly
- 400 lbs. max capacity for cable units; 310 lbs. for web units
- Cable units range from 23–50 feet, available in galvanized or stainless steel
- Web units range from 7–23 feet



3M™ Thor™ Galvanized Cable Lifeline

- Durable aluminum housing
- Spring cushion cable guide helps reduce cable rewind damage
- Swivel top housing for enhanced mobility
- 310 lbs. max capacity
- Cable units range from 10–30 feet, available in galvanized or stainless steel
- Web units range from 7–50 feet



3M™ Retractable Lifeline (G-Series)

- Versatile product suitable for multiple industries
- Assembled in the U.S.A. from high quality materials
- Rugged durability and lightweight design
- 310 lbs. max capacity
- Cable units range from 20–50 feet, available in galvanized or stainless steel
- Web units range from 7–20 feet



Model	UPC	Qty./Case
REC-23	78371-01132-8	1

Model	UPC	Qty./Case
M-30	78371-00359-0	1

Model	UPC	Qty./Case
GW-11	78371-64164-8	1

Anchorage Devices

3M™ SafeClaw Reusable Concrete Anchor

- Trigger mechanism allows unit to be easily inserted and removed from pre-drilled poured concrete
- Available in 5000 lbs. (Model 4075) and 10,000 lbs. (Model 4077) rated designs



Model	UPC	Qty./Case
4075	78371-01071-0	1
4077	78371-01162-5	1

3M™ Reusable Roof Anchor

- Hinged anchor for wood and metal decking
- Steel design
- Fits most pitch angles
- Appropriate for Horizontal Lifeline Applications



Model	UPC	Qty./Case
4000	78371-00050-6	1

3M™ Beamwalk III

- Lightweight aluminum construction
- Dual axis swivel D-ring helps prevent entanglement
- Smooth sliding, non-chattering mobility across exposed I and H beams



Model	UPC	Qty./Case
4650-3	78371-62716-1	1

3M™ Industrial Anchor

- Permanent D-bolt anchor
- Includes nut, bolt and washer hardware



Model	UPC	Qty./Case
4005	78371-00053-7	1

Kits

3M™ General Fall Protection Kit

- Designed for use with rental lifts
- Includes 3M™ SafeLight™ Harness (10910), 6-ft 3M™ SafeLight™ Lanyard (209512) and tool bag for equipment storage
- Can be personalized with a customer logo



Model	UPC	Qty./Case
30500	78371-00088-9	1

3M™ Roofing Kit

- A complete Personal Fall Arrest System in a bucket
- Includes 3M™ SafeLight™ Harness (10910), 6-ft 3M™ SafeLight™ Lanyard (209512), 3M™ Reusable Roof Anchor (4000), 50-ft Lifeline with attached Rope Grab (0221-50RG) and 5-gallon storage bucket



Model	UPC	Qty./Case
20058	78371-00086-5	1





See Warning on Page 146

3M™ Maintenance Aerosols

3M™ Maintenance Aerosols

3M's line of aerosol cleaners are the fast and easy solution for removing grease, grime, inks, and residues on electrical equipment and components.

Product Number/Description	Size	UPC	Qty./Case
3M™ 5-Way Penetrant			
 <ul style="list-style-type: none"> • Inhibits rust and corrosion by spreading a thin, even film that actually penetrates the pores of the surface • It displaces moisture and “dries out” electrical parts and equipment to help prevent shorting and increase conductivity • Spray it on to free rusted, frozen bolts, nuts, and screws • Lubricate delicate machines and precision instruments • Penetrates and demisterizes • Ideal as a tapping lubricant for stainless steel and aluminum • Contains no methylene chloride, 1, 1, 1-trichloroethane or chlorofluorocarbons 	24 fl. oz.	021200-21305-2	12
3M™ Citrus Base Cleaner			
 <ul style="list-style-type: none"> • Multi-purpose cleaner • Will dissolve and flush away dirt, grease, tar, most noncuring type adhesive films and similar substances • Citrus oil-based cleaner that emulsifies when flushed with water • Contains no petroleum distillates • Use to clean and degrease metal parts, motors, tools, printing presses and concrete • Contains no methylene chloride, 1, 1, 1-trichlorofluorocarbons 	24 fl. oz.	021200-76394-6	12
3M™ Stainless Steel Cleaner and Polish			
 <ul style="list-style-type: none"> • Cleans and polishes stainless steel, chrome aluminum and laminated plastic surfaces • High gloss in one step • Contains no ozone depleting chemical 	21 fl. oz.	048011-14002-0	12



3M™ Electrical Products

Product Number/Description	Size	UPC	Qty./Case
Scotch® Vinyl Electrical Tape Super 33+			
 <ul style="list-style-type: none"> • Provides primary electrical insulation for splices up to 600V • Abrasion corrosion and UV-resistant • Makes an excellent protective jacketing for high-voltage cables and wire harnessing • UL listed and CSA certified • Resists alkalis and acids, flame retardant • Excellent all-weather performance in cold to 0°F (-18°C) or hot to 220°F (105°C) 	3/4" x 66'	054007-06132-8	100

3M™ Facility Care Products

3M™ Safety-Walk™ Matting

Spring-coiled vinyl foam compresses uniformly and continually, providing greater comfort and less fatigue.

Product Number/Description	Color	Size	UPC	Qty./Case
3270 (No Edging)				
 <ul style="list-style-type: none"> • Economical matting ideal for fatigue resistance in dry environments • Textured, solid surface improves traction and allows debris and liquid to stay on top of the mat for easy cleanup • Lightweight for easy moving and repositioning • No edging 	Black	3' x 10'	048011-34821-6	1
	Black	3' x 20'	048011-34823-0	1
3270E (Black Edging)				
 <ul style="list-style-type: none"> • Economical matting ideal for fatigue resistance in dry environments • Textured, solid surface improves traction and allows debris and liquid to stay on top of the mat for easy cleanup • Lightweight for easy moving and repositioning • Integral edging on the long edge of the mat and nosing on the ends 	Black with Black Edging	3' x 5'	048011-34826-1	1
	Black with Black Edging	3' x 10'	048011-34828-5	1
	Black with Black Edging	3' x 20'	048011-34830-8	1
	Black with Black Edging	4' x 6'	048011-34827-8	1
	Black with Black Edging	4' x 10'	048011-34829-2	1

